

# LMV321, LMV358, LMV324

## Single, Dual, Quad Low-Voltage, Rail-to-Rail Operational Amplifiers

The LMV321, LMV358, and LMV324 are CMOS single, dual, and quad low voltage operational amplifiers with rail-to-rail output swing. These amplifiers are a cost-effective solution for applications where low power consumption and space saving packages are critical. Specification tables are provided for operation from power supply voltages at 2.7 V and 5 V. Rail-to-Rail operation provides improved signal-to-noise performance. Ultra low quiescent current makes this series of amplifiers ideal for portable, battery operated equipment. The common mode input range includes ground making the device useful for low-side current-shunt measurements. The ultra small packages allow for placement on the PCB in close proximity to the signal source thereby reducing noise pickup.

### Features

- Operation from 2.7 V to 5.0 V Single-Sided Power Supply
- LMV321 Single Available in Ultra Small 5 Pin SC70 Package
- No Output Crossover Distortion
- Industrial temperature Range:  $-40^{\circ}\text{C}$  to  $+85^{\circ}\text{C}$
- Rail-to-Rail Output
- Low Quiescent Current: LMV358 Dual – 220  $\mu\text{A}$ , Max per Channel
- No Output Phase-Reversal from Overdriven Input
- These are Pb-Free Devices

### Typical Applications

- Notebook Computers and PDA's
- Portable Battery-Operated Instruments
- Active Filters

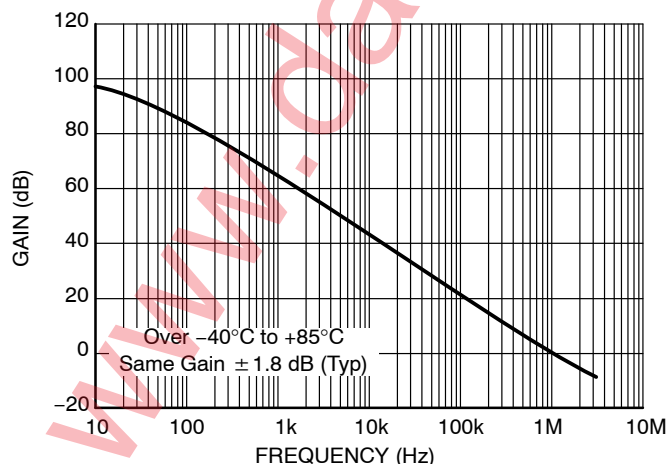

Figure 1. Open Loop Frequency Response  
( $R_L = 2 \text{ k}\Omega$ ,  $T_A = 25^{\circ}\text{C}$ ,  $V_S = 5 \text{ V}$ )

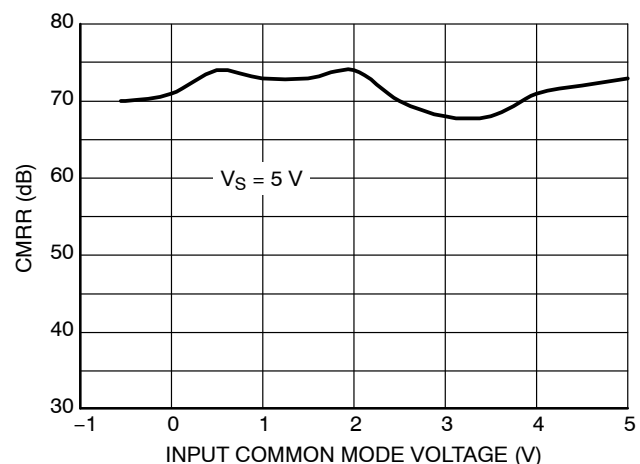

Figure 2. CMRR vs. Input Common Mode Voltage



ON Semiconductor®

<http://onsemi.com>



SC-70  
CASE 419A



TSOP-5  
CASE 483



Micro8™  
CASE 846A

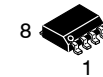

SOIC-8  
CASE 751



UDFN8  
CASE 517AJ



SOIC-14  
CASE 751A

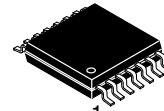

TSSOP-14  
CASE 948G

### ORDERING AND MARKING INFORMATION

See detailed ordering and shipping information in the package dimensions section on page 12 of this data sheet.

# LMV321, LMV358, LMV324

## MARKING DIAGRAMS

SC-70

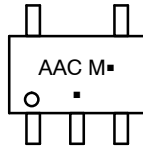

AAC = Specific Device Code  
 M = Date Code  
 ■ = Pb-Free Package  
 (Note: Microdot may be in either location)

TSOP-5

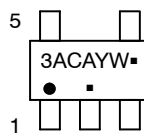

3AC = Specific Device Code  
 A = Assembly Location  
 Y = Year  
 W = Work Week  
 ■ = Pb-Free Package  
 (Note: Microdot may be in either location)

Micro8

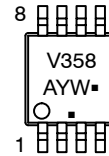

V358 = Specific Device Code  
 A = Assembly Location  
 Y = Year  
 W = Work Week  
 ■ = Pb-Free Package  
 (Note: Microdot may be in either location)

SOIC-8

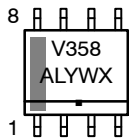

V358 = Specific Device Code  
 A = Assembly Location  
 L = Wafer Lot  
 Y = Year  
 W = Work Week  
 ■ = Pb-Free Package

UDFN8

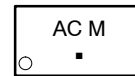

AC = Specific Device Code  
 M = Date Code  
 ■ = Pb-Free Package

SOIC-14

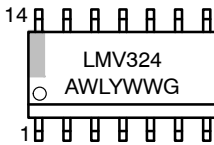

LMV324 = Specific Device Code  
 A = Assembly Location  
 WL = Wafer Lot  
 Y = Year  
 WW = Work Week  
 G = Pb-Free Package

TSSOP-14

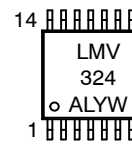

LMV324 = Specific Device Code  
 A = Assembly Location  
 L = Wafer Lot  
 Y = Year  
 W = Work Week  
 ■ = Pb-Free Package

## PIN CONNECTIONS

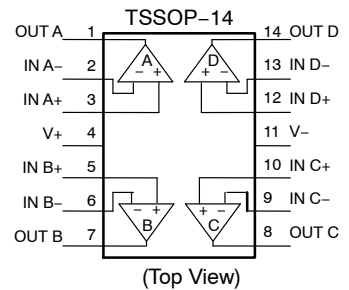
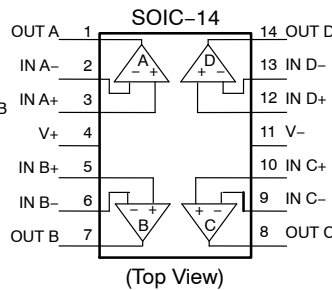
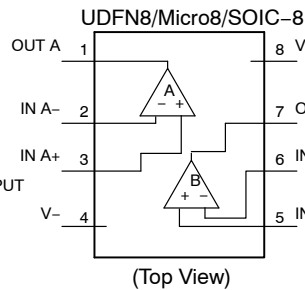
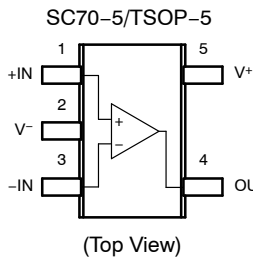

# LMV321, LMV358, LMV324

## MAXIMUM RATINGS

Symbol	Rating	Value	Unit
V <sub>S</sub>	Supply Voltage (Operating Range V <sub>S</sub> = 2.7 V to 5.5 V)	5.5	V
V <sub>IDR</sub>	Input Differential Voltage	± Supply Voltage	V
V <sub>ICR</sub>	Input Common Mode Voltage Range	-0.5 to (V+) + 0.5	V
	Maximum Input Current	10	mA
t <sub>So</sub>	Output Short Circuit (Note 1)	Continuous	
T <sub>J</sub>	Maximum Junction Temperature (Operating Range -40°C to 85°C)	150	°C
θ <sub>JA</sub>	Thermal Resistance:		°C/W
	SC-70	280	
	Micro8	238	
	TSOP-5	333	
	UDFN8 (1.2 mm x 1.8 mm x 0.5 mm)	350	
	SOIC-8	212	
	SOIC-14	156	
	TSSOP-14	190	
T <sub>stg</sub>	Storage Temperature	-65 to 150	°C
	Mounting Temperature (Infrared or Convection -20 sec)	235	°C
V <sub>ESD</sub>	ESD Tolerance		V
	LMV321		
	Machine Model	100	
	Human Body Model	1000	
LMV358/324			
Machine Model	100		
Human Body Mode	2000		

Stresses exceeding Maximum Ratings may damage the device. Maximum Ratings are stress ratings only. Functional operation above the Recommended Operating Conditions is not implied. Extended exposure to stresses above the Recommended Operating Conditions may affect device reliability.

1. Continuous short-circuit operation to ground at elevated ambient temperature can result in exceeding the maximum allowed junction temperature of 150°C. Output currents in excess of 45 mA over long term may adversely affect reliability. Shorting output to either V+ or V- will adversely affect reliability.

## LMV321, LMV358, LMV324

**2.7 V DC ELECTRICAL CHARACTERISTICS** (Unless otherwise specified, all limits are guaranteed for  $T_A = 25^\circ\text{C}$ ,  $V^+ = 2.7\text{ V}$ ,  $R_L = 1\text{ M}\Omega$ ,  $V^- = 0\text{ V}$ ,  $V_O = V^+/2$ )

Parameter	Symbol	Condition	Min	Typ	Max	Unit
Input Offset Voltage	$V_{IO}$	$T_A = -40^\circ\text{C to } +85^\circ\text{C}$		1.7	9	mV
Input Offset Voltage Average Drift	$ICV_{OS}$	$T_A = -40^\circ\text{C to } +85^\circ\text{C}$		5		$\mu\text{V}/^\circ\text{C}$
Input Bias Current	$I_B$	$T_A = -40^\circ\text{C to } +85^\circ\text{C}$		<1		nA
Input Offset Current	$I_{IO}$	$T_A = -40^\circ\text{C to } +85^\circ\text{C}$		<1		nA
Common Mode Rejection Ratio	CMRR	$0\text{ V} \leq V_{CM} \leq 1.7\text{ V}$	50	63		dB
Power Supply Rejection Ratio	PSRR	$2.7\text{ V} \leq V^+ \leq 5\text{ V}$ , $V_O = 1\text{ V}$	50	60		dB
Input Common-Mode Voltage Range	$V_{CM}$	For CMRR $\geq 50\text{ dB}$	0 to 1.7	-0.2 to 1.9		V
Output Swing	$V_{OH}$	$R_L = 10\text{ k}\Omega\text{ to } 1.35\text{ V}$	$V_{CC} - 100$	$V_{CC} - 10$		mV
	$V_{OL}$	$R_L = 10\text{ k}\Omega\text{ to } 1.35\text{ V}$ (Note 2)		60	180	mV
Supply Current	$I_{CC}$			80	185	$\mu\text{A}$
LMV321				140	340	
LMV358 (Both Amplifiers) LMV324 (4 Amplifiers)				260	680	

**2.7 V AC ELECTRICAL CHARACTERISTICS** (Unless otherwise specified, all limits are guaranteed for  $T_A = 25^\circ\text{C}$ ,  $V^+ = 2.7\text{ V}$ ,  $R_L = 1\text{ M}\Omega$ ,  $V^- = 0\text{ V}$ ,  $V_O = V^+/2$ )

Parameter	Symbol	Condition	Min	Typ	Max	Unit
Gain Bandwidth Product	GBWP	$C_L = 200\text{ pF}$		1		MHz
Phase Margin	$\Theta_m$			60		$^\circ$
Gain Margin	$G_m$			10		dB
Input-Referred Voltage Noise	$e_n$	$f = 50\text{ kHz}$		50		$\text{nV}/\sqrt{\text{Hz}}$

2. Guaranteed by design and/or characterization.

## LMV321, LMV358, LMV324

**5.0 V DC ELECTRICAL CHARACTERISTICS** (Unless otherwise specified, all limits are guaranteed for  $T_A = 25^\circ\text{C}$ ,  $V^+ = 5.0\text{ V}$ ,  $R_L = 1\text{ M}\Omega$ ,  $V^- = 0\text{ V}$ ,  $V_O = V^+/2$ )

Parameter	Symbol	Condition	Min	Typ	Max	Unit
Input Offset Voltage	$V_{IO}$	$T_A = -40^\circ\text{C}$ to $+85^\circ\text{C}$		1.7	9	mV
Input Offset Voltage Average Drift	$T_C V_{IO}$	$T_A = -40^\circ\text{C}$ to $+85^\circ\text{C}$		5		$\mu\text{V}/^\circ\text{C}$
Input Bias Current (Note 3)	$I_B$	$T_A = -40^\circ\text{C}$ to $+85^\circ\text{C}$		< 1		nA
Input Offset Current (Note 3)	$I_{IO}$	$T_A = -40^\circ\text{C}$ to $+85^\circ\text{C}$		< 1		nA
Common Mode Rejection Ratio	CMRR	$0\text{ V} \leq V_{CM} \leq 4\text{ V}$	50	65		dB
Power Supply Rejection Ratio	PSRR	$2.7\text{ V} \leq V^+ \leq 5\text{ V}$ , $V_O = 1\text{ V}$ , $V_{CM} = 1\text{ V}$	50	60		dB
Input Common-Mode Voltage Range	$V_{CM}$	For CMRR $\geq 50\text{ dB}$	0 to 4	-0.2 to 4.2		V
Large Signal Voltage Gain (Note 3)	$A_V$	$R_L = 2\text{ k}\Omega$	15	100		V/mV
		$T_A = -40^\circ\text{C}$ to $+85^\circ\text{C}$	10			
Output Swing	$V_{OH}$	$R_L = 2\text{ k}\Omega$ to $2.5\text{ V}$ $T_A = -40^\circ\text{C}$ to $+85^\circ\text{C}$	$V_{CC} - 300$ $V_{CC} - 400$	$V_{CC} - 40$		V
	$V_{OL}$	$R_L = 2\text{ k}\Omega$ to $2.5\text{ V}$ (Note 3) $T_A = -40^\circ\text{C}$ to $+85^\circ\text{C}$		120	300 400	mV
	$V_{OH}$	$R_L = 10\text{ k}\Omega$ to $2.5\text{ V}$ (Note 3) $T_A = -40^\circ\text{C}$ to $+85^\circ\text{C}$	$V_{CC} - 100$ $V_{CC} - 200$			V
	$V_{OL}$	$R_L = 10\text{ k}\Omega$ to $2.5\text{ V}$ $T_A = -40^\circ\text{C}$ to $+85^\circ\text{C}$		65	180 280	mV
Output Short Circuit Current	$I_O$	Sourcing = $V_O = 0\text{ V}$ (Note 3)	10	60		mA
		Sinking = $V_O = 5\text{ V}$ (Note 3)	10	160		
Supply Current	$I_{CC}$	LMV321 $T_A = -40^\circ\text{C}$ to $+85^\circ\text{C}$		130	250 350	$\mu\text{A}$
		LMV358 Both Amplifiers $T_A = -40^\circ\text{C}$ to $+85^\circ\text{C}$		210	440 615	
		LMV324 All Four Amplifiers $T_A = -40^\circ\text{C}$ to $+85^\circ\text{C}$		410	830 1160	

**5.0 V AC ELECTRICAL CHARACTERISTICS** (Unless otherwise specified, all limits are guaranteed for  $T_A = 25^\circ\text{C}$ ,  $V^+ = 5.0\text{ V}$ ,  $R_L = 1\text{ M}\Omega$ ,  $V^- = 0\text{ V}$ ,  $V_O = V^+/2$ )

Parameter	Symbol	Condition	Min	Typ	Max	Unit
Slew Rate	$S_R$			1		V/ $\mu\text{s}$
Gain Bandwidth Product	GBWP	$C_L = 200\text{ pF}$		1		MHz
Phase Margin	$\Theta_m$			60		$^\circ$
Gain Margin	$G_m$			10		dB
Input-Referred Voltage Noise	$e_n$	$f = 50\text{ kHz}$		50		$\text{nV}/\sqrt{\text{Hz}}$

3. Guaranteed by design and/or characterization.

# LMV321, LMV358, LMV324

## TYPICAL CHARACTERISTICS

( $T_A = 25^\circ\text{C}$  and  $V_S = 5\text{ V}$  unless otherwise specified)

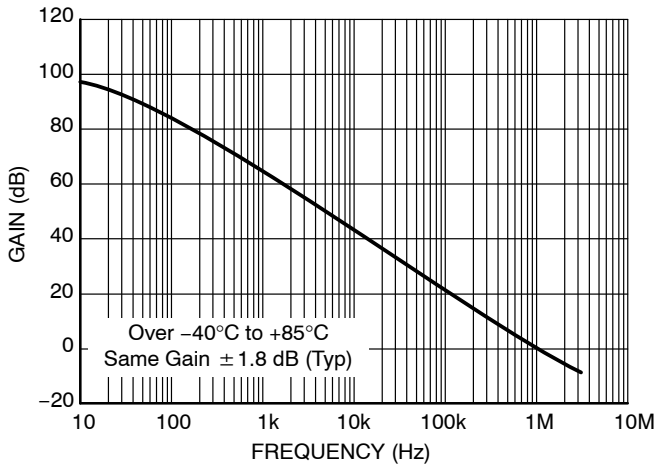

**Figure 3. Open Loop Frequency Response**  
( $R_L = 2\text{ k}\Omega$ ,  $T_A = 25^\circ\text{C}$ ,  $V_S = 5\text{ V}$ )

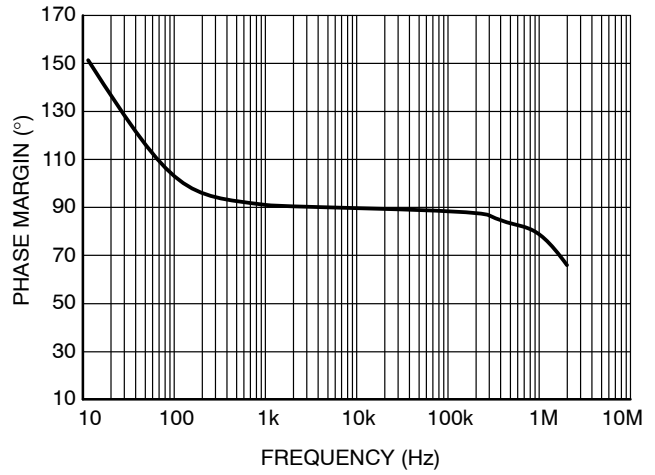

**Figure 4. Open Loop Phase Margin**  
( $R_L = 2\text{ k}\Omega$ ,  $T_A = 25^\circ\text{C}$ ,  $V_S = 5\text{ V}$ )

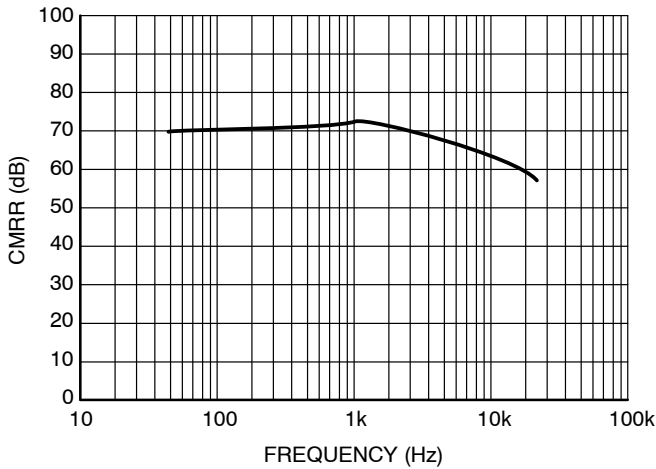

**Figure 5. CMRR vs. Frequency**  
( $R_L = 5\text{ k}\Omega$ ,  $V_S = 5\text{ V}$ )

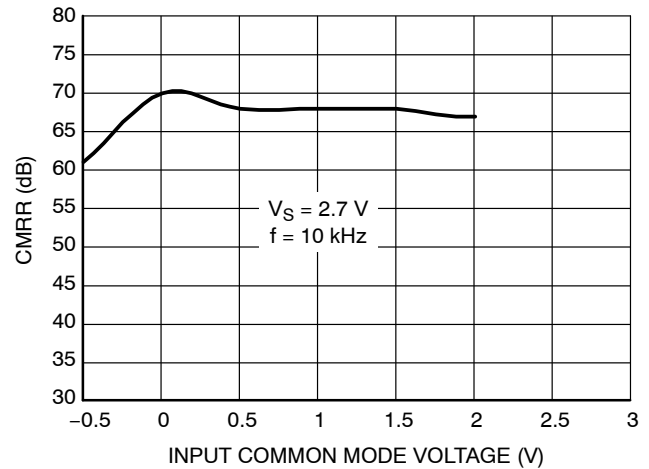

**Figure 6. CMRR vs. Input Common Mode Voltage**

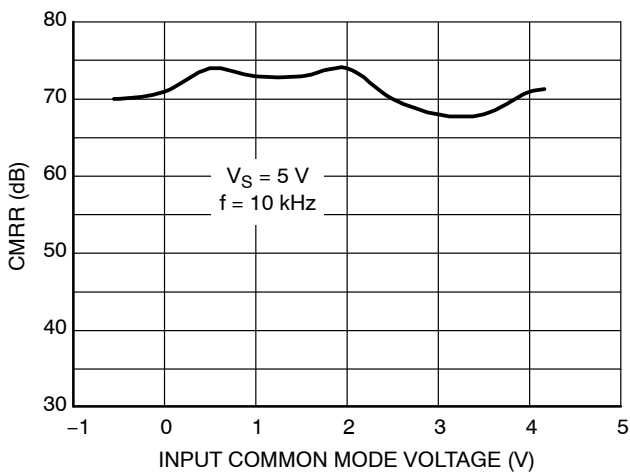

**Figure 7. CMRR vs. Input Common Mode Voltage**

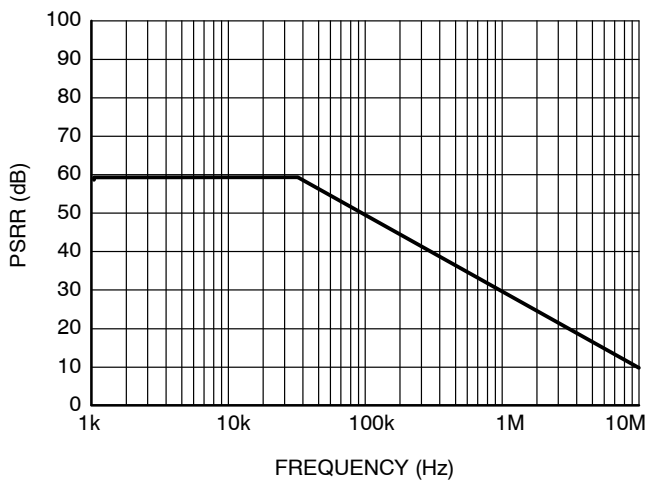
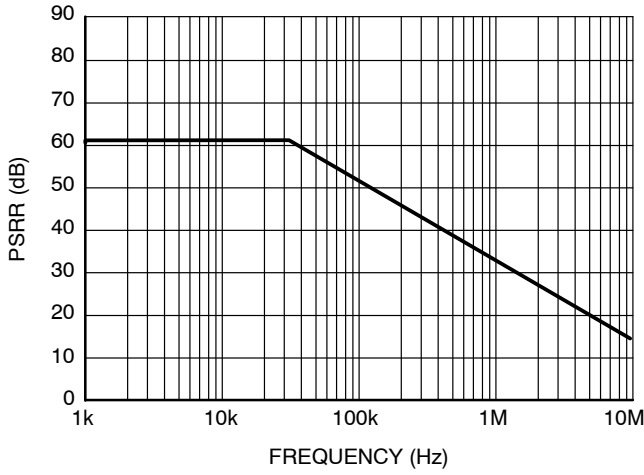

**Figure 8. PSRR vs. Frequency**  
( $R_L = 5\text{ k}\Omega$ ,  $V_S = 2.7\text{ V}$ , +PSRR)

# LMV321, LMV358, LMV324

## TYPICAL CHARACTERISTICS

( $T_A = 25^\circ\text{C}$  and  $V_S = 5\text{ V}$  unless otherwise specified)



**Figure 9. PSRR vs. Frequency**  
( $R_L = 5\text{ k}\Omega$ ,  $V_S = 2.7\text{ V}$ , -PSRR)

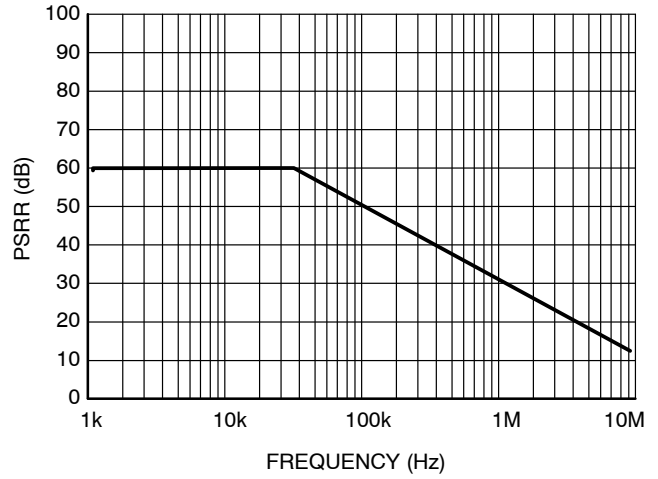

**Figure 10. PSRR vs. Frequency**  
( $R_L = 5\text{ k}\Omega$ ,  $V_S = 5\text{ V}$ , +PSRR)

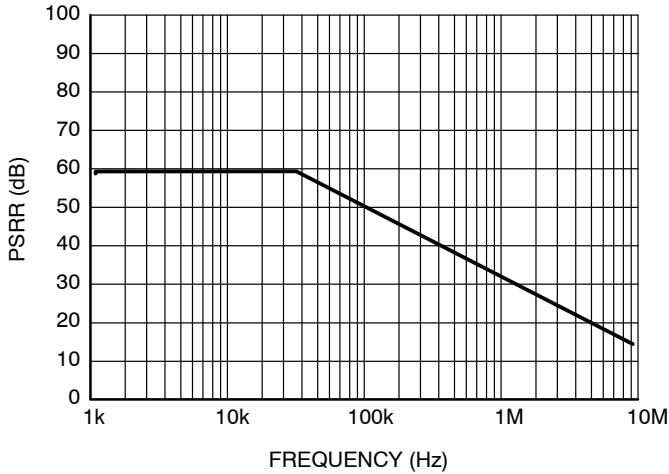

**Figure 11. PSRR vs. Frequency**  
( $R_L = 5\text{ k}\Omega$ ,  $V_S = 5\text{ V}$ , -PSRR)

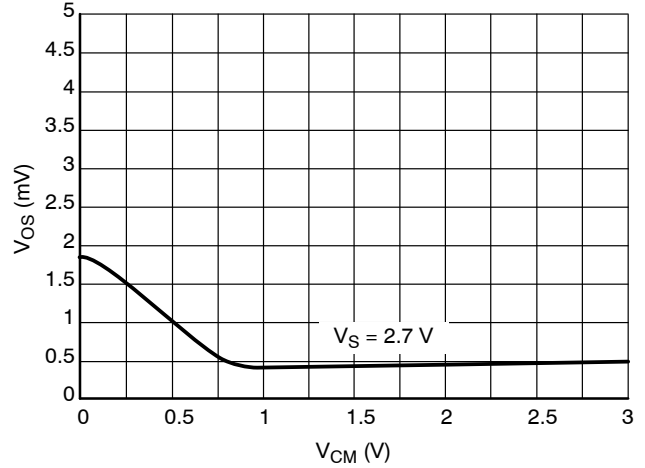

**Figure 12.  $V_{OS}$  vs. CMR**

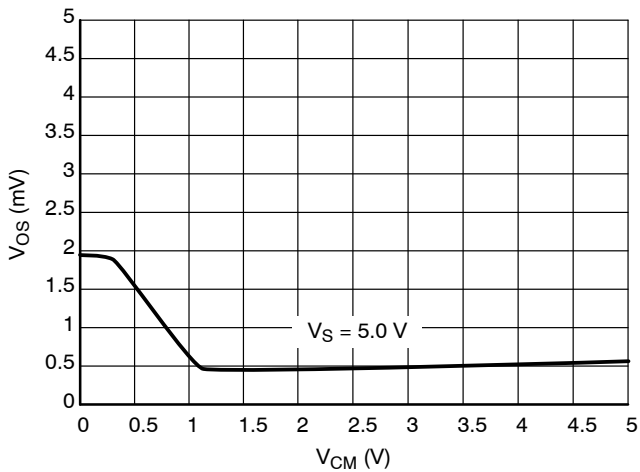

**Figure 13.  $V_{OS}$  vs. CMR**

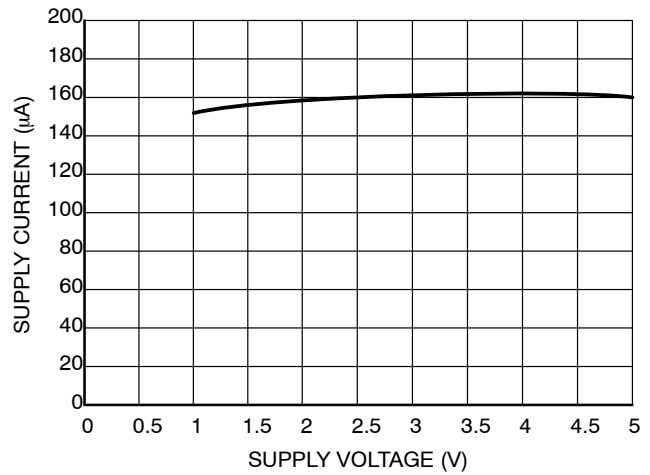

**Figure 14. Supply Current vs. Supply Voltage**

# LMV321, LMV358, LMV324

## TYPICAL CHARACTERISTICS

( $T_A = 25^\circ\text{C}$  and  $V_S = 5\text{ V}$  unless otherwise specified)

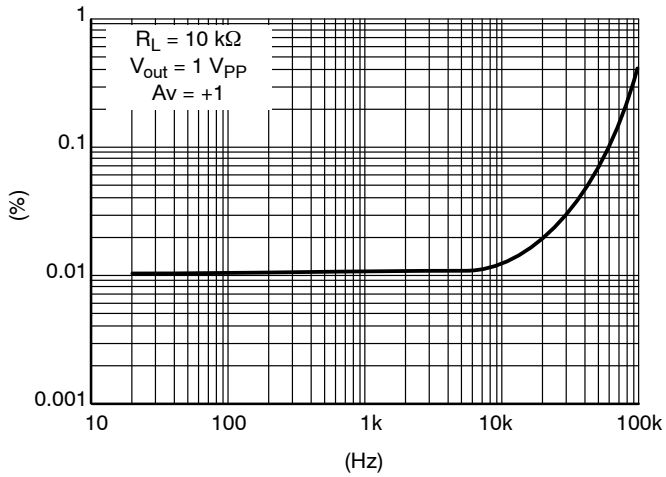

Figure 15. THD+N vs Frequency

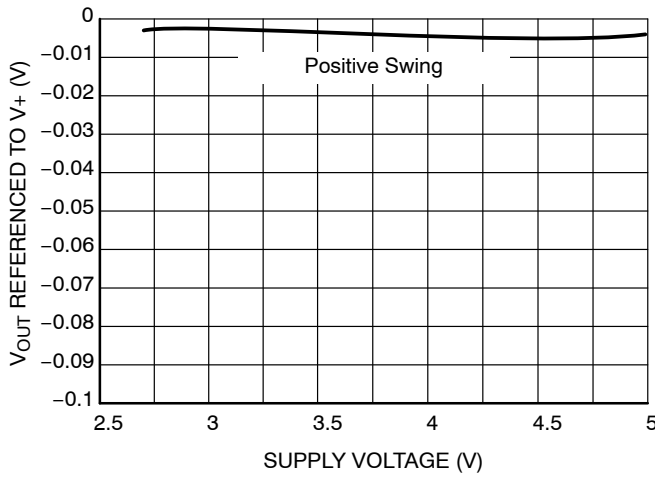

Figure 16. Output Voltage Swing vs Supply Voltage ( $R_L = 10\text{ k}$ )

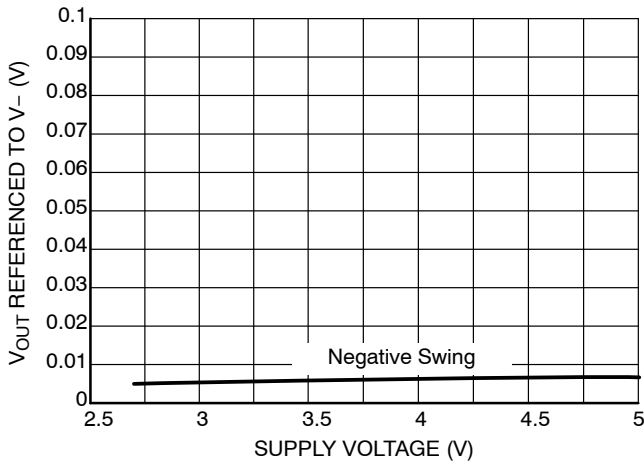

Figure 17. Output Voltage Swing vs Supply Voltage ( $R_L = 10\text{ k}$ )

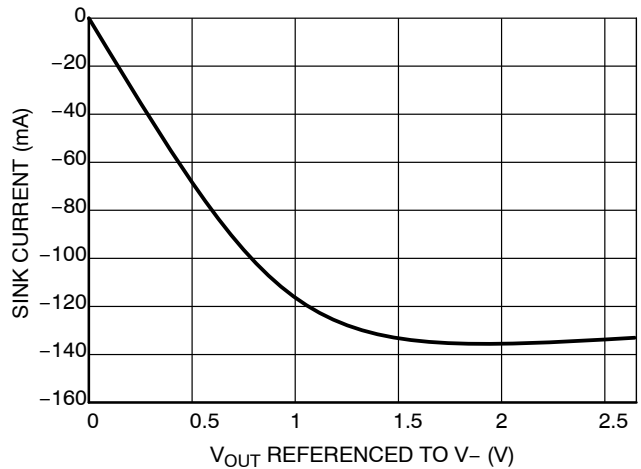

Figure 18. Sink Current vs. Output Voltage  $V_S = 2.7\text{ V}$

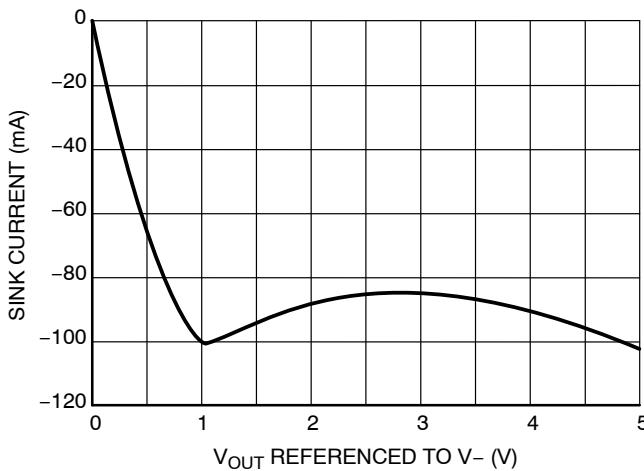

Figure 19. Sink Current vs. Output Voltage  $V_S = 5.0\text{ V}$

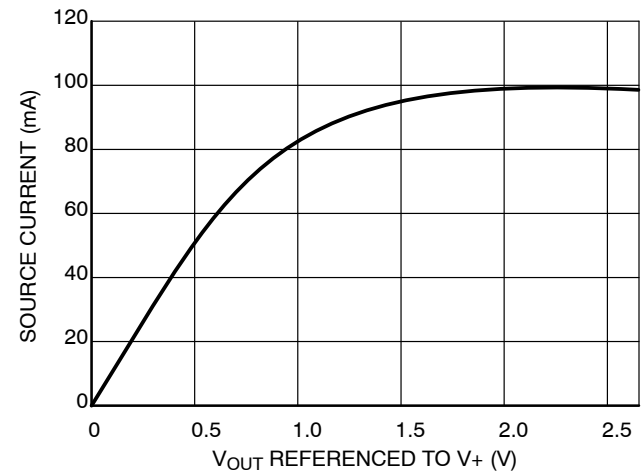

Figure 20. Source Current vs. Output Voltage  $V_S = 2.7\text{ V}$



# LMV321, LMV358, LMV324

## TYPICAL CHARACTERISTICS

( $T_A = 25^\circ\text{C}$  and  $V_S = 5\text{ V}$  unless otherwise specified)

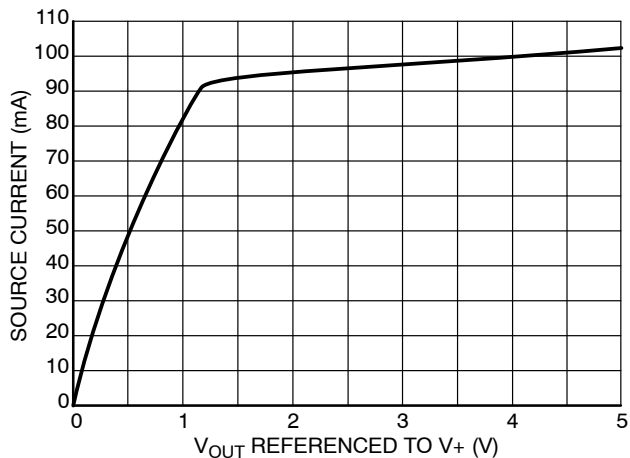

**Figure 21. Source Current vs. Output Voltage**  
 $V_S = 5.0\text{ V}$

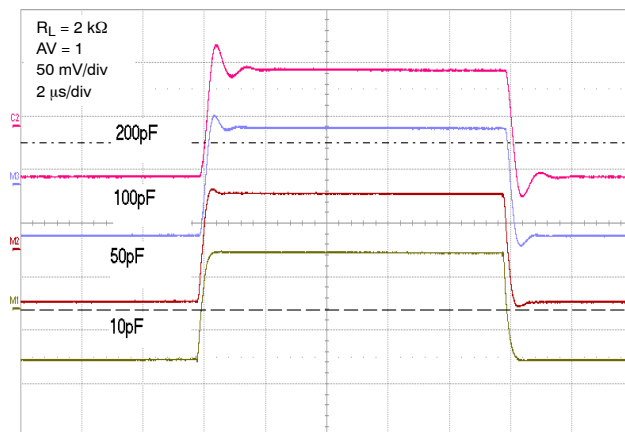

**Figure 22. Settling Time vs. Capacitive Load**

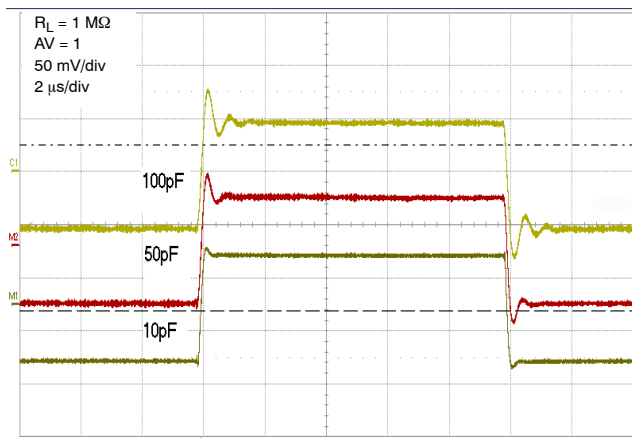

**Figure 23. Settling Time vs. Capacitive Load**

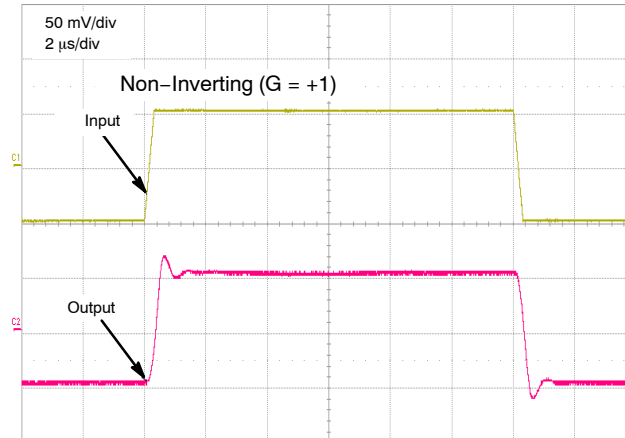

**Figure 24. Step Response – Small Signal**

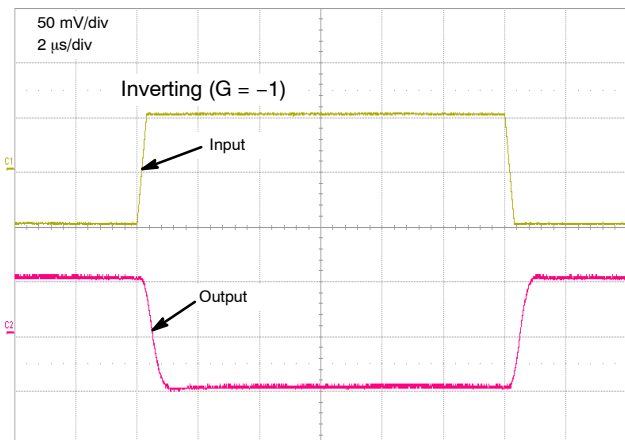

**Figure 25. Step Response – Small Signal**

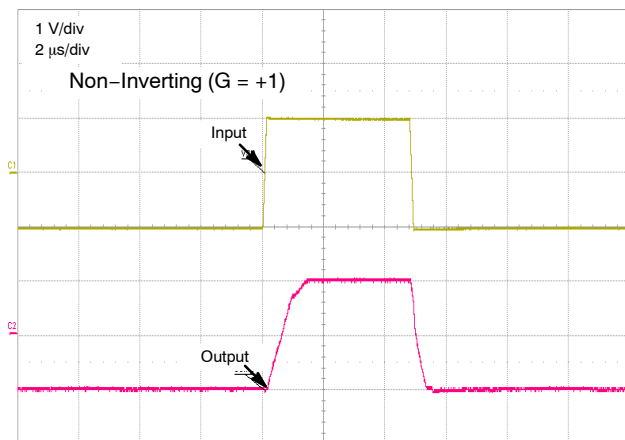
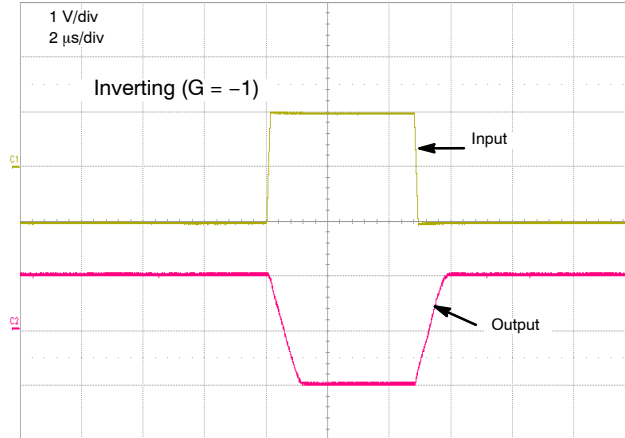

**Figure 26. Step Response – Large Signal**

# LMV321, LMV358, LMV324

## TYPICAL CHARACTERISTICS

( $T_A = 25^\circ\text{C}$  and  $V_S = 5\text{ V}$  unless otherwise specified)



**Figure 27. Step Response – Large Signal**

# LMV321, LMV358, LMV324

## APPLICATIONS

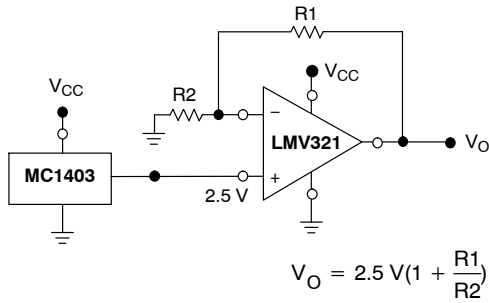

Figure 28. Voltage Reference

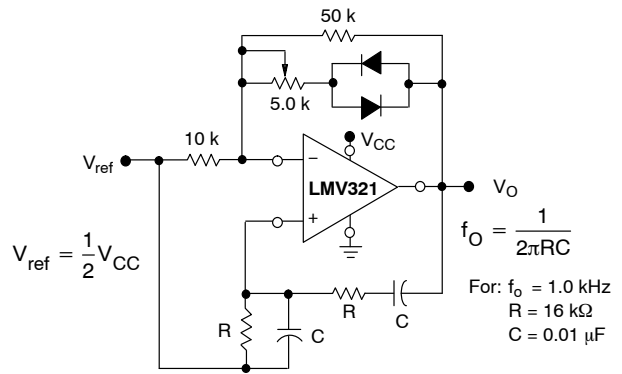

Figure 29. Wien Bridge Oscillator

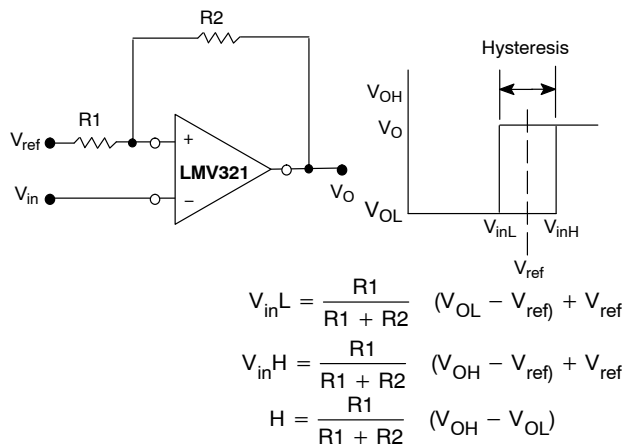
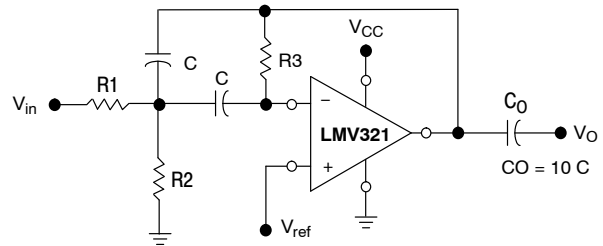

Figure 30. Comparator with Hysteresis



Given:  $f_o$  = center frequency  
 $A(f_o)$  = gain at center frequency

Choose value  $f_o, C$

$$\text{Then : } R3 = \frac{Q}{\pi f_o C}$$

$$R1 = \frac{R3}{2 A(f_o)}$$

$$R2 = \frac{R1 R3}{4Q^2 R1 - R3}$$

For less than 10% error from operational amplifier,  
 $((Q_o f_o)/BW) < 0.1$  where  $f_o$  and  $BW$  are expressed in Hz.  
 If source impedance varies, filter may be preceded with  
 voltage follower buffer to stabilize filter parameters.

Figure 31. Multiple Feedback Bandpass Filter

## LMV321, LMV358, LMV324

### ORDERING INFORMATION

Order Number	Number of Channels	Specific Device Marking	Package Type	Shipping†
LMV321SQ3T2G	Single	AAC	SC-70 (Pb-Free)	3000 / Tape & Reel
LMV321SN3T1G*	Single	3AC	TSOP-5 (Pb-Free)	3000 / Tape & Reel
LMV358DMR2G	Dual	V358	Micro8 (Pb-Free)	4000 / Tape & Reel
LMV358MUTAG	Dual	AC	UDFN8 (Pb-Free)	3000 / Tape & Reel
LMV358DR2G	Dual	V358	SOIC-8 (Pb-Free)	2500 / Tape & Reel
LMV324DR2G	Quad	LMV324	SOIC-14 (Pb-Free)	2500 / Tape & Reel
LMV324DTBR2G	Quad	LMV 324	TSSOP-14 (Pb-Free)	2500 / Tape & Reel

†For information on tape and reel specifications, including part orientation and tape sizes, please refer to our Tape and Reel Packaging Specifications Brochure, BRD8011/D.

\*Contact factory.

# LMV321, LMV358, LMV324

## PACKAGE DIMENSIONS

SC-88A, SOT-353, SC-70  
CASE 419A-02  
ISSUE J

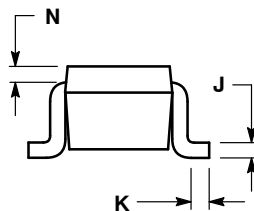
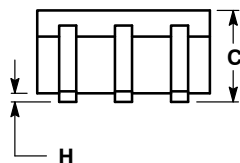
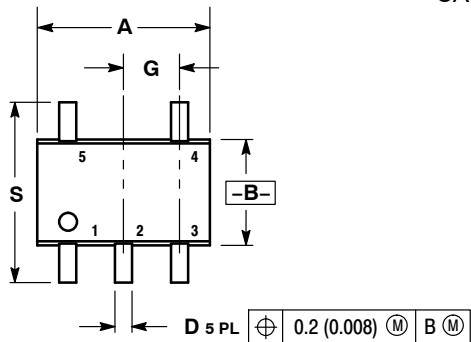

NOTES:

1. DIMENSIONING AND TOLERANCING PER ANSI Y14.5M, 1982.
2. CONTROLLING DIMENSION: INCH.
3. 419A-01 OBSOLETE. NEW STANDARD 419A-02.
4. DIMENSIONS A AND B DO NOT INCLUDE MOLD FLASH, PROTRUSIONS, OR GATE BURRS.

DIM	INCHES		MILLIMETERS	
	MIN	MAX	MIN	MAX
A	0.071	0.087	1.80	2.20
B	0.045	0.053	1.15	1.35
C	0.031	0.043	0.80	1.10
D	0.004	0.012	0.10	0.30
G	0.026 BSC		0.65 BSC	
H	---	0.004	---	0.10
J	0.004	0.010	0.10	0.25
K	0.004	0.012	0.10	0.30
N	0.008 REF		0.20 REF	
S	0.079	0.087	2.00	2.20

# LMV321, LMV358, LMV324

## PACKAGE DIMENSIONS

### TSOP-5 CASE 483-02 ISSUE H

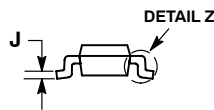
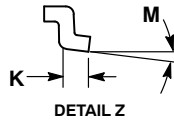
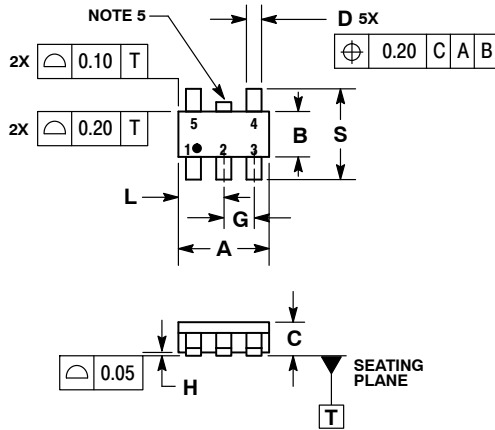

**NOTES:**

1. DIMENSIONING AND TOLERANCING PER ASME Y14.5M, 1994.
2. CONTROLLING DIMENSION: MILLIMETERS.
3. MAXIMUM LEAD THICKNESS INCLUDES LEAD FINISH THICKNESS. MINIMUM LEAD THICKNESS IS THE MINIMUM THICKNESS OF BASE MATERIAL.
4. DIMENSIONS A AND B DO NOT INCLUDE MOLD FLASH, PROTRUSIONS, OR GATE BURRS.
5. OPTIONAL CONSTRUCTION: AN ADDITIONAL TRIMMED LEAD IS ALLOWED IN THIS LOCATION. TRIMMED LEAD NOT TO EXTEND MORE THAN 0.2 FROM BODY.

DIM	MILLIMETERS	
	MIN	MAX
A	3.00 BSC	
B	1.50 BSC	
C	0.90	1.10
D	0.25	0.50
G	0.95 BSC	
H	0.01	0.10
J	0.10	0.26
K	0.20	0.60
L	1.25	1.55
M	0°	10°
S	2.50	3.00

### SOLDERING FOOTPRINT\*

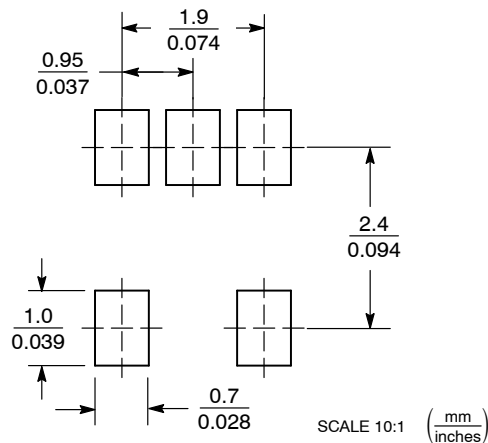

\*For additional information on our Pb-Free strategy and soldering details, please download the ON Semiconductor Soldering and Mounting Techniques Reference Manual, SOLDERRM/D.

# LMV321, LMV358, LMV324

## PACKAGE DIMENSIONS

Micro8™  
CASE 846A-02  
ISSUE H

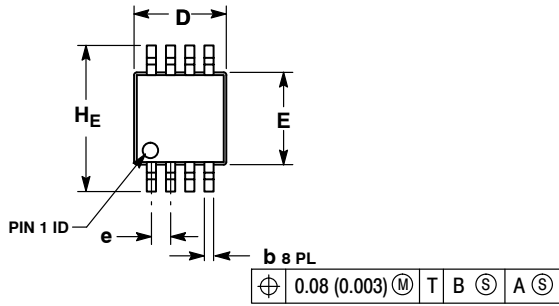

NOTES:

1. DIMENSIONING AND TOLERANCING PER ANSI Y14.5M, 1982.
2. CONTROLLING DIMENSION: MILLIMETER.
3. DIMENSION A DOES NOT INCLUDE MOLD FLASH, PROTRUSIONS OR GATE BURRS. MOLD FLASH, PROTRUSIONS OR GATE BURRS SHALL NOT EXCEED 0.15 (0.006) PER SIDE.
4. DIMENSION B DOES NOT INCLUDE INTERLEAD FLASH OR PROTRUSION. INTERLEAD FLASH OR PROTRUSION SHALL NOT EXCEED 0.25 (0.010) PER SIDE.
5. 846A-01 OBSOLETE, NEW STANDARD 846A-02.

DIM	MILLIMETERS			INCHES		
	MIN	NOM	MAX	MIN	NOM	MAX
A	--	--	1.10	--	--	0.043
A1	0.05	0.08	0.15	0.002	0.003	0.006
b	0.25	0.33	0.40	0.010	0.013	0.016
c	0.13	0.18	0.23	0.005	0.007	0.009
D	2.90	3.00	3.10	0.114	0.118	0.122
E	2.90	3.00	3.10	0.114	0.118	0.122
e	0.65 BSC			0.026 BSC		
L	0.40	0.55	0.70	0.016	0.021	0.028
HE	4.75	4.90	5.05	0.187	0.193	0.199

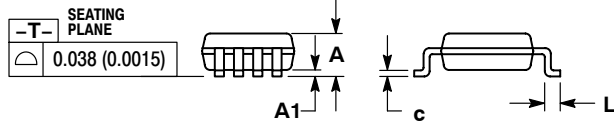

### SOLDERING FOOTPRINT\*

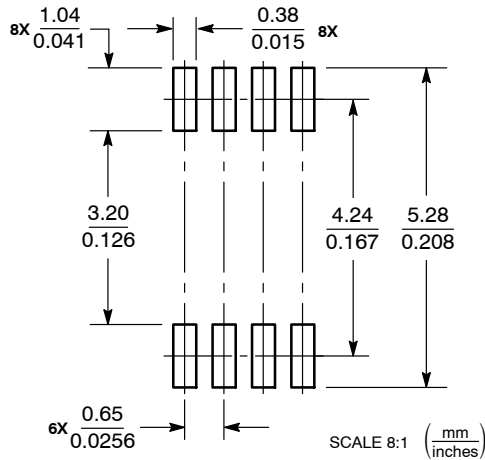

\*For additional information on our Pb-Free strategy and soldering details, please download the ON Semiconductor Soldering and Mounting Techniques Reference Manual, SOLDERRM/D.

# LMV321, LMV358, LMV324

## PACKAGE DIMENSIONS

SOIC-8 NB  
CASE 751-07  
ISSUE AJ

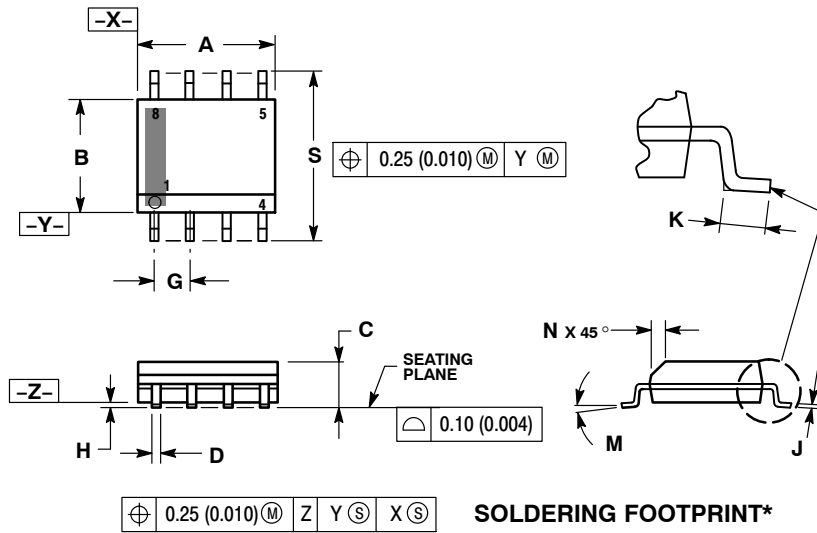

NOTES:

1. DIMENSIONING AND TOLERANCING PER ANSI Y14.5M, 1982.
2. CONTROLLING DIMENSION: MILLIMETER.
3. DIMENSION A AND B DO NOT INCLUDE MOLD PROTRUSION.
4. MAXIMUM MOLD PROTRUSION 0.15 (0.006) PER SIDE.
5. DIMENSION D DOES NOT INCLUDE DAMBAR PROTRUSION. ALLOWABLE DAMBAR PROTRUSION SHALL BE 0.127 (0.005) TOTAL IN EXCESS OF THE D DIMENSION AT MAXIMUM MATERIAL CONDITION.
6. 751-01 THRU 751-06 ARE OBSOLETE. NEW STANDARD IS 751-07.

DIM	MILLIMETERS		INCHES	
	MIN	MAX	MIN	MAX
A	4.80	5.00	0.189	0.197
B	3.80	4.00	0.150	0.157
C	1.35	1.75	0.053	0.069
D	0.33	0.51	0.013	0.020
G	1.27 BSC		0.050 BSC	
H	0.10	0.25	0.004	0.010
J	0.19	0.25	0.007	0.010
K	0.40	1.27	0.016	0.050
M	0°	8°	0°	8°
N	0.25	0.50	0.010	0.020
S	5.80	6.20	0.228	0.244

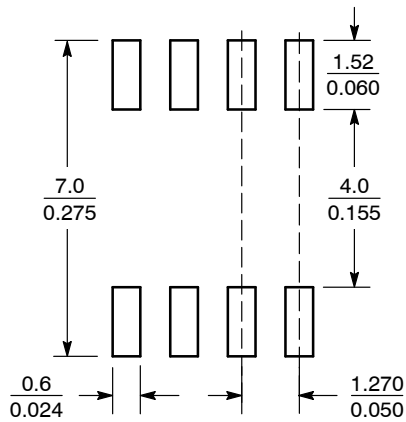

SCALE 6:1 (mm/inches)

\*For additional information on our Pb-Free strategy and soldering details, please download the ON Semiconductor Soldering and Mounting Techniques Reference Manual, SOLDERRM/D.



# LMV321, LMV358, LMV324

## PACKAGE DIMENSIONS

UDFN8 1.8x1.2, 0.4P  
CASE 517AJ-01  
ISSUE O

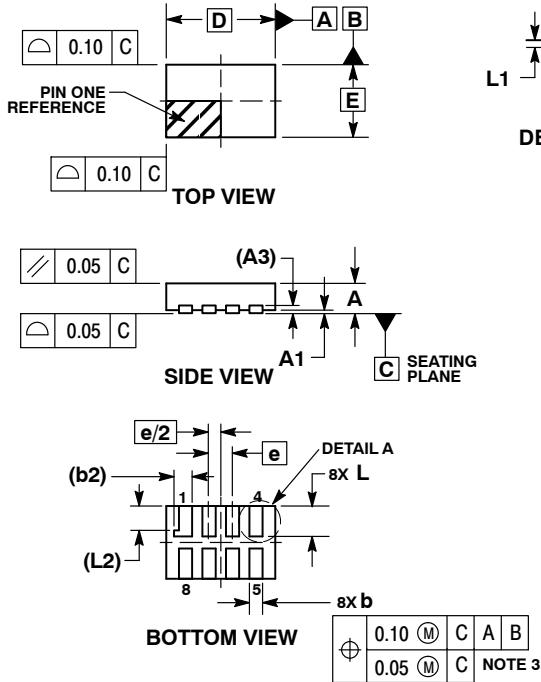

**NOTES:**

1. DIMENSIONING AND TOLERANCING PER ASME Y14.5M, 1994.
2. CONTROLLING DIMENSION: MILLIMETERS.
3. DIMENSION b APPLIES TO PLATED TERMINAL AND IS MEASURED BETWEEN 0.15 AND 0.30 mm FROM TERMINAL TIP.
4. MOLD FLASH ALLOWED ON TERMINALS ALONG EDGE OF PACKAGE. FLASH MAY NOT EXCEED 0.03 ONTO BOTTOM SURFACE OF TERMINALS.
5. DETAIL A SHOWS OPTIONAL CONSTRUCTION FOR TERMINALS.

DIM	MILLIMETERS	
	MIN	MAX
A	0.45	0.55
A1	0.00	0.05
A3	0.127	REF
b	0.15	0.25
b2	0.30	REF
D	1.80	BSC
E	1.20	BSC
e	0.40	BSC
L	0.45	0.55
L1	0.00	0.03
L2	0.40	REF

**MOUNTING FOOTPRINT\*  
SOLDERMASK DEFINED**

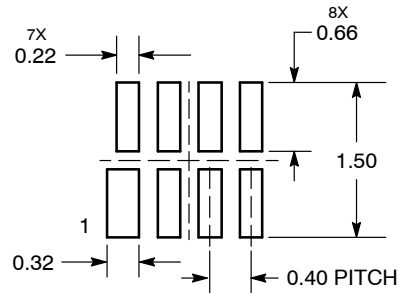

DIMENSIONS: MILLIMETERS

\*For additional information on our Pb-Free strategy and soldering details, please download the ON Semiconductor Soldering and Mounting Techniques Reference Manual, SOLDERRM/D.

# LMV321, LMV358, LMV324

## PACKAGE DIMENSIONS

SOIC-14  
CASE 751A-03  
ISSUE J

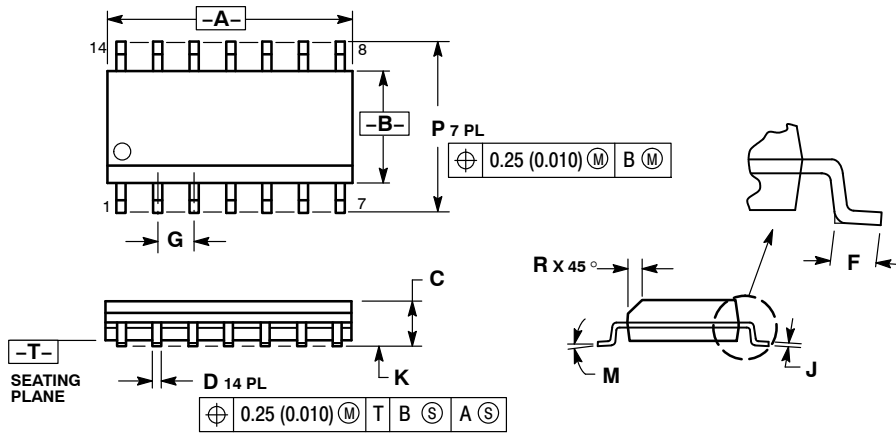

NOTES:

1. DIMENSIONING AND TOLERANCING PER ANSI Y14.5M, 1982.
2. CONTROLLING DIMENSION: MILLIMETER.
3. DIMENSIONS A AND B DO NOT INCLUDE MOLD PROTRUSION.
4. MAXIMUM MOLD PROTRUSION 0.15 (0.006) PER SIDE.
5. DIMENSION D DOES NOT INCLUDE DAMBAR PROTRUSION. ALLOWABLE DAMBAR PROTRUSION SHALL BE 0.127 (0.005) TOTAL IN EXCESS OF THE D DIMENSION AT MAXIMUM MATERIAL CONDITION.

MILLIMETERS		INCHES		
DIM	MIN	MAX	MIN	MAX
A	8.55	8.75	0.337	0.344
B	3.80	4.00	0.150	0.157
C	1.35	1.75	0.054	0.068
D	0.35	0.49	0.014	0.019
F	0.40	1.25	0.016	0.049
G	1.27 BSC		0.050 BSC	
J	0.19	0.25	0.008	0.009
K	0.10	0.25	0.004	0.009
M	0° - 7°		0° - 7°	
P	5.80	6.20	0.228	0.244
R	0.25	0.50	0.010	0.019

### SOLDERING FOOTPRINT

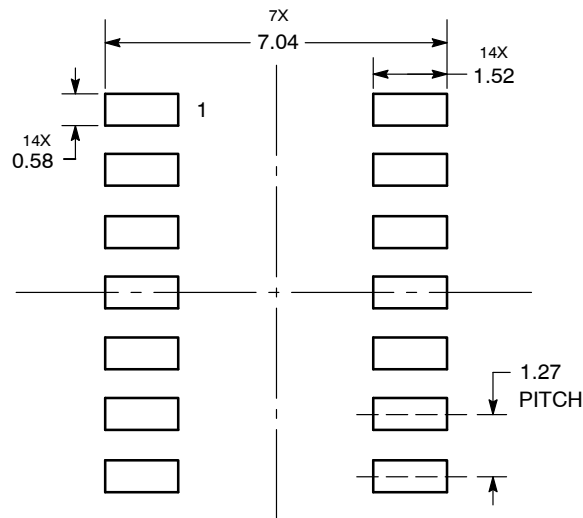

DIMENSIONS: MILLIMETERS

\*For additional information on our Pb-Free strategy and soldering details, please download the ON Semiconductor Soldering and Mounting Techniques Reference Manual, SOLDERRM/D.

# LMV321, LMV358, LMV324

## PACKAGE DIMENSIONS

TSSOP-14  
CASE 948G-01  
ISSUE B

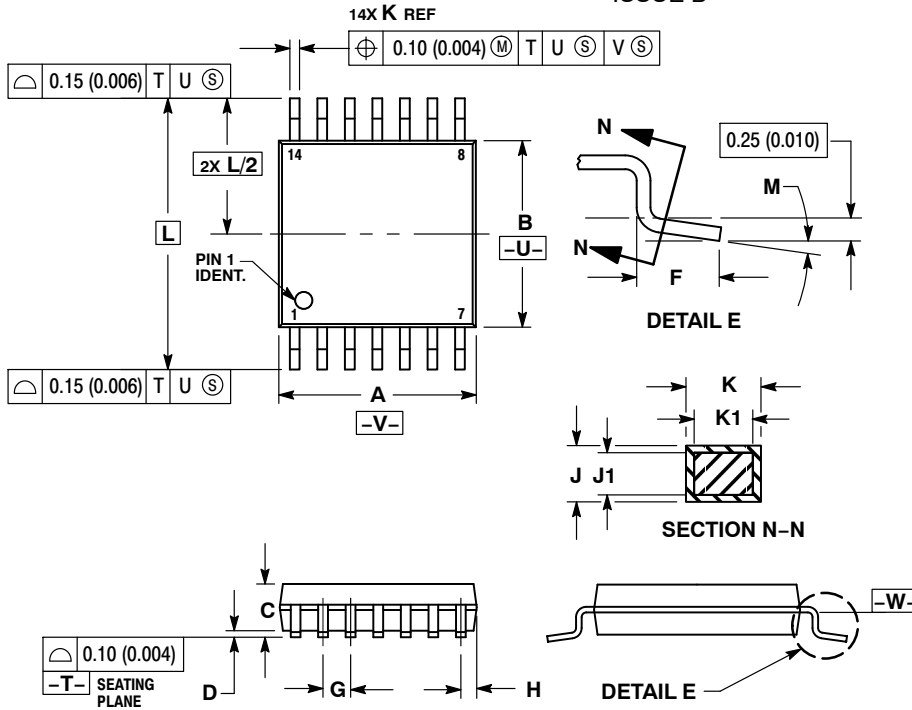

NOTES:

1. DIMENSIONING AND TOLERANCING PER ANSI Y14.5M, 1982.
2. CONTROLLING DIMENSION: MILLIMETER.
3. DIMENSION A DOES NOT INCLUDE MOLD FLASH, PROTRUSIONS OR GATE BURRS. MOLD FLASH OR GATE BURRS SHALL NOT EXCEED 0.15 (0.006) PER SIDE.
4. DIMENSION B DOES NOT INCLUDE INTERLEAD FLASH OR PROTRUSION. INTERLEAD FLASH OR PROTRUSION SHALL NOT EXCEED 0.25 (0.010) PER SIDE.
5. DIMENSION K DOES NOT INCLUDE DAMBAR PROTRUSION. ALLOWABLE DAMBAR PROTRUSION SHALL BE 0.08 (0.003) TOTAL IN EXCESS OF THE K DIMENSION AT MAXIMUM MATERIAL CONDITION.
6. TERMINAL NUMBERS ARE SHOWN FOR REFERENCE ONLY.
7. DIMENSION A AND B ARE TO BE DETERMINED AT DATUM PLANE -W-.

DIM	MILLIMETERS		INCHES	
	MIN	MAX	MIN	MAX
A	4.90	5.10	0.193	0.200
B	4.30	4.50	0.169	0.177
C	---	1.20	---	0.047
D	0.05	0.15	0.002	0.006
F	0.50	0.75	0.020	0.030
G	0.65 BSC		0.026 BSC	
H	0.50	0.60	0.020	0.024
J	0.09	0.20	0.004	0.008
J1	0.09	0.16	0.004	0.006
K	0.19	0.30	0.007	0.012
K1	0.19	0.25	0.007	0.010
L	6.40 BSC		0.252 BSC	
M	0°	8°	0°	8°

### SOLDERING FOOTPRINT\*

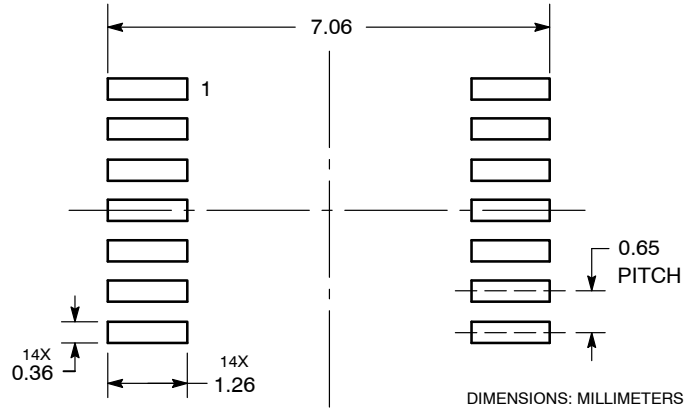

\*For additional information on our Pb-Free strategy and soldering details, please download the ON Semiconductor Soldering and Mounting Techniques Reference Manual, SOLDERRM/D.

# LMV321, LMV358, LMV324

Micro8 is a trademark of International Rectifier.

**ON Semiconductor** and  are registered trademarks of Semiconductor Components Industries, LLC (SCILLC). SCILLC reserves the right to make changes without further notice to any products herein. SCILLC makes no warranty, representation or guarantee regarding the suitability of its products for any particular purpose, nor does SCILLC assume any liability arising out of the application or use of any product or circuit, and specifically disclaims any and all liability, including without limitation special, consequential or incidental damages. "Typical" parameters which may be provided in SCILLC data sheets and/or specifications can and do vary in different applications and actual performance may vary over time. All operating parameters, including "Typicals" must be validated for each customer application by customer's technical experts. SCILLC does not convey any license under its patent rights nor the rights of others. SCILLC products are not designed, intended, or authorized for use as components in systems intended for surgical implant into the body, or other applications intended to support or sustain life, or for any other application in which the failure of the SCILLC product could create a situation where personal injury or death may occur. Should Buyer purchase or use SCILLC products for any such unintended or unauthorized application, Buyer shall indemnify and hold SCILLC and its officers, employees, subsidiaries, affiliates, and distributors harmless against all claims, costs, damages, and expenses, and reasonable attorney fees arising out of, directly or indirectly, any claim of personal injury or death associated with such unintended or unauthorized use, even if such claim alleges that SCILLC was negligent regarding the design or manufacture of the part. SCILLC is an Equal Opportunity/Affirmative Action Employer. This literature is subject to all applicable copyright laws and is not for resale in any manner.

## PUBLICATION ORDERING INFORMATION

### LITERATURE FULFILLMENT:

Literature Distribution Center for ON Semiconductor  
P.O. Box 5163, Denver, Colorado 80217 USA  
**Phone:** 303-675-2175 or 800-344-3860 Toll Free USA/Canada  
**Fax:** 303-675-2176 or 800-344-3867 Toll Free USA/Canada  
**Email:** [orderlit@onsemi.com](mailto:orderlit@onsemi.com)

**N. American Technical Support:** 800-282-9855 Toll Free  
USA/Canada  
**Europe, Middle East and Africa Technical Support:**  
Phone: 421 33 790 2910  
**Japan Customer Focus Center**  
Phone: 81-3-5773-3850

**ON Semiconductor Website:** [www.onsemi.com](http://www.onsemi.com)  
**Order Literature:** <http://www.onsemi.com/orderlit>  
For additional information, please contact your local  
Sales Representative