

**Silicon Schottky Diode**

- General-purpose diode for high-speed switching
- Circuit protection
- Voltage clamping
- High-level detecting and mixing

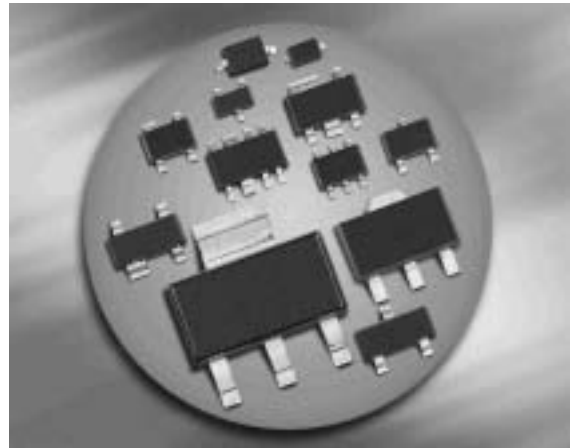

**BAS140W**  
**BAS40-02L**

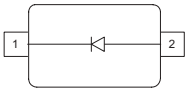

**BAS40**

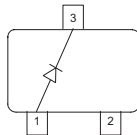

**BAS40-04**

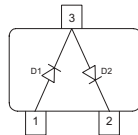

**BAS40-05**  
**BAS40-05W**

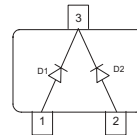

**BAS40-06**  
**BAS40-06W**

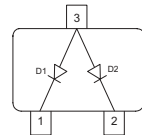

**BAS40-07**  
**BAS40-07W**

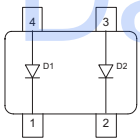

Datasheet.Directory

**ESD: Electrostatic discharge sensitive device, observe handling precaution!**

Type	Package	Configuration	$L_S$ (nH)	Marking
BAS140W	SOD323	single	1.8	white 4
BAS40	SOT23	single	1.8	43s
BAS40-02L	TSLP-2-1	single, leadless	0.4	FF
BAS40-04	SOT23	series	1.8	44s
BAS40-05	SOT23	common cathode	1.8	45s
BAS40-05W	SOT323	common cathode	1.4	45s
BAS40-06	SOT23	common anode	1.8	46s
BAS40-06W	SOT323	common anode	1.4	46s
BAS40-07	SOT143	parallel pair	2	47s
BAS40-07W	SOT343	parallel pair	1.6	47s

**Maximum Ratings at  $T_A = 25^\circ\text{C}$ , unless otherwise specified**

Parameter	Symbol	Value	Unit
Diode reverse voltage	$V_R$	40	V
Forward current	$I_F$	120	mA
Non-repetitive peak surge forward current $t \leq 10\text{ms}$	$I_{FSM}$	200	
Total power dissipation BAS140W, $T_S \leq 113^\circ\text{C}$ BAS40, BAS40-07, $T_S \leq 81^\circ\text{C}$ BAS40-02L, $T_S \leq 127^\circ\text{C}$ BAS40-04, BAS40-06, $T_S \leq 56^\circ\text{C}$ BAS40-06W, $T_S \leq 106^\circ\text{C}$ BAS40-05, $T_S \leq 31^\circ\text{C}$ BAS40-05W, $T_S \leq 98^\circ\text{C}$ BAS40-07W, $T_S \leq 118^\circ\text{C}$	$P_{tot}$	250 250 250 250 250 250 250 250	mW
Junction temperature	$T_j$	150	$^\circ\text{C}$
Operating temperature range	$T_{op}$	-55 ... 125	
Storage temperature	$T_{stg}$	-55 ... 150	

**Thermal Resistance**

Parameter	Symbol	Value	Unit
Junction - soldering point <sup>1)</sup> BAS140W BAS40, BAS40-07 BAS40-02L BAS40-04, BAS40-06 BAS40-06W BAS40-05 BAS40-05W BAS40-07W	$R_{thJS}$	$\leq 150$ $\leq 275$ $\leq 90$ $\leq 375$ $\leq 175$ $\leq 475$ $\leq 205$ $\leq 125$	K/W

<sup>1)</sup>For calculation of  $R_{thJA}$  please refer to Application Note Thermal Resistance

**Electrical Characteristics at  $T_A = 25^\circ\text{C}$ , unless otherwise specified**

Parameter	Symbol	Values			Unit
		min.	typ.	max.	
<b>DC Characteristics</b>					
Breakdown voltage $I_{(BR)} = 10 \mu\text{A}$	$V_{(BR)}$	40	-	-	V
Reverse current $V_R = 30 \text{ V}$	$I_R$	-	-	1	$\mu\text{A}$
Forward voltage $I_F = 1 \text{ mA}$ $I_F = 10 \text{ mA}$ $I_F = 40 \text{ mA}$	$V_F$	250 350 600	310 450 720	380 500 1000	mV
Forward voltage matching <sup>1)</sup> $I_F = 10 \text{ mA}$	$\Delta V_F$	-	-	20	

**AC Characteristics**

Diode capacitance $V_R = 0, f = 1 \text{ MHz}$	$C_T$	-	3	5	pF
Differential forward resistance $I_F = 10 \text{ mA}, f = 10 \text{ kHz}$	$R_F$	-	10	-	$\Omega$
Charge carrier life time $I_F = 25 \text{ mA}$	$\tau_{rr}$	-	-	100	ps

<sup>1)</sup> $\Delta V_F$  is the difference between lowest and highest  $V_F$  in a multiple diode component.

**Diode capacitance  $C_T = f(V_R)$**

$f = 1\text{MHz}$

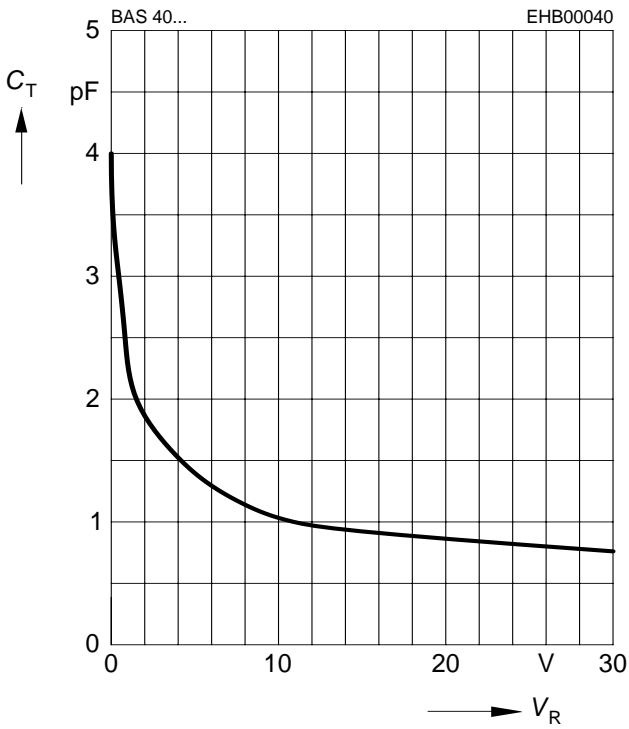

**Forward resistance  $r_f = f(I_F)$**

$f = 10\text{kHz}$

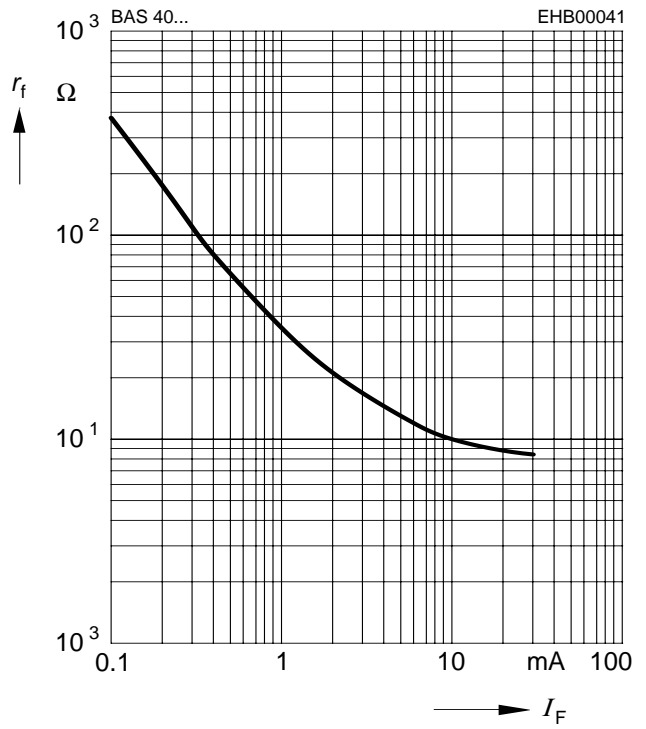

**Reverse current  $I_R = f(V_R)$**

$T_A = \text{Parameter}$

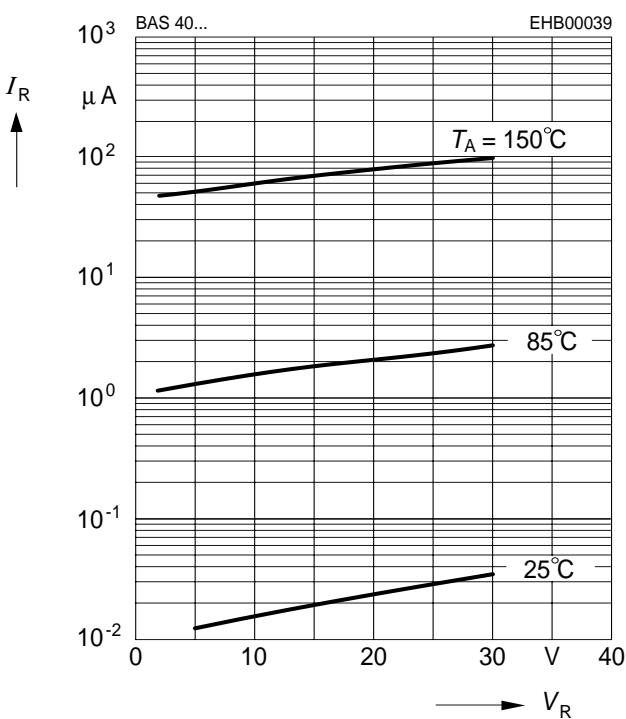

**Forward current  $I_F = f(V_F)$**

$T_A = \text{Parameter}$

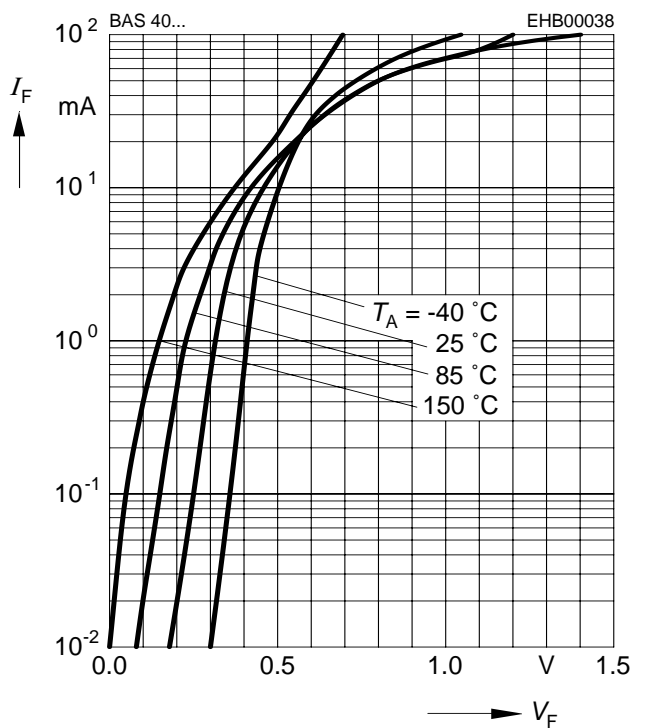

Forward current  $I_F = f(T_S)$

BAS140W

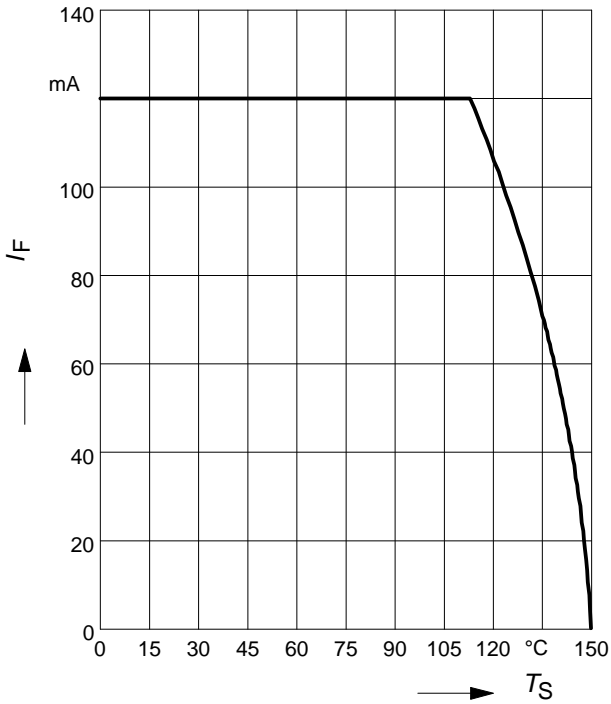

Forward current  $I_F = f(T_S)$

BAS40, BAS40-07

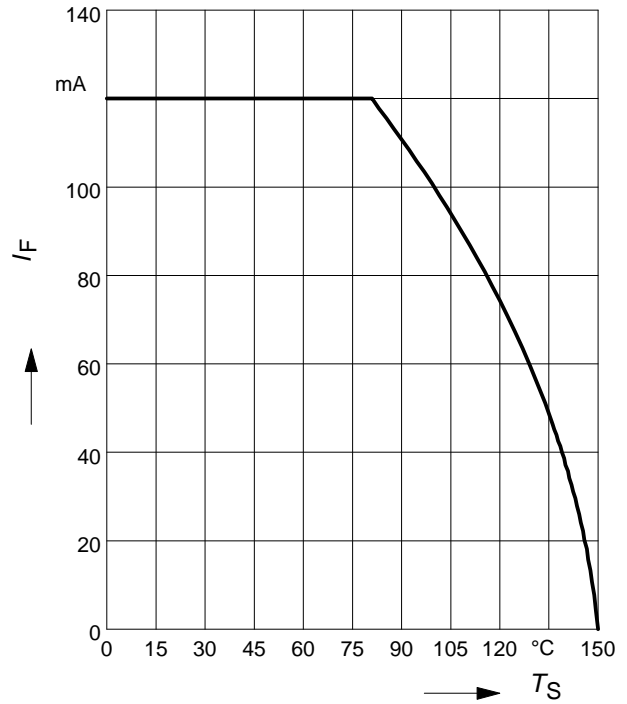

Forward current  $I_F = f(T_S)$

BAS40-02L

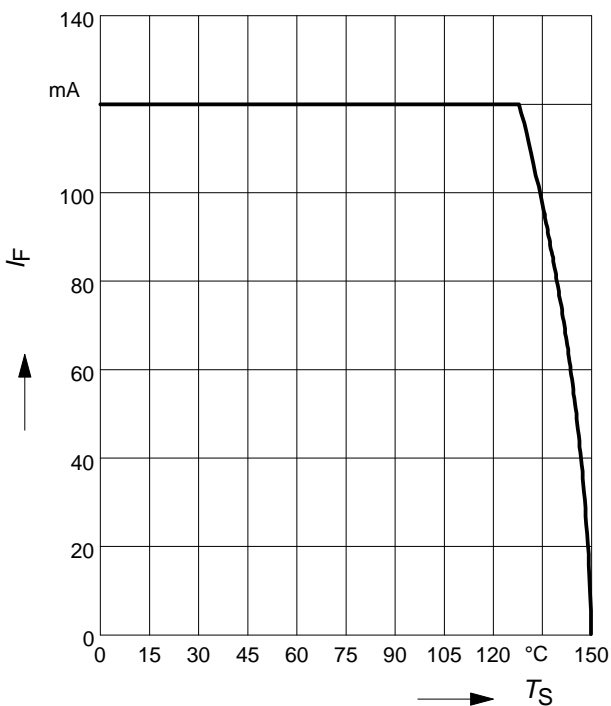

Forward current  $I_F = f(T_S)$

BAS40-04, BAS40-06

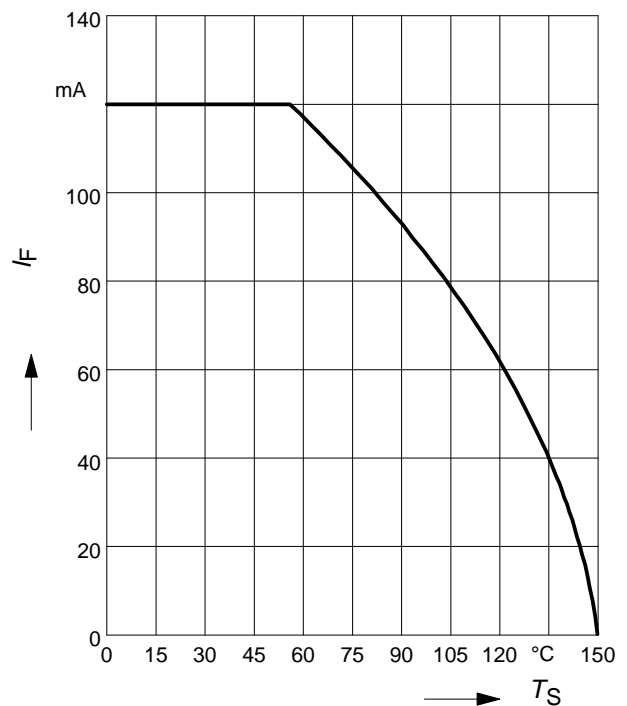

Forward current  $I_F = f(T_S)$

BAS40-06W

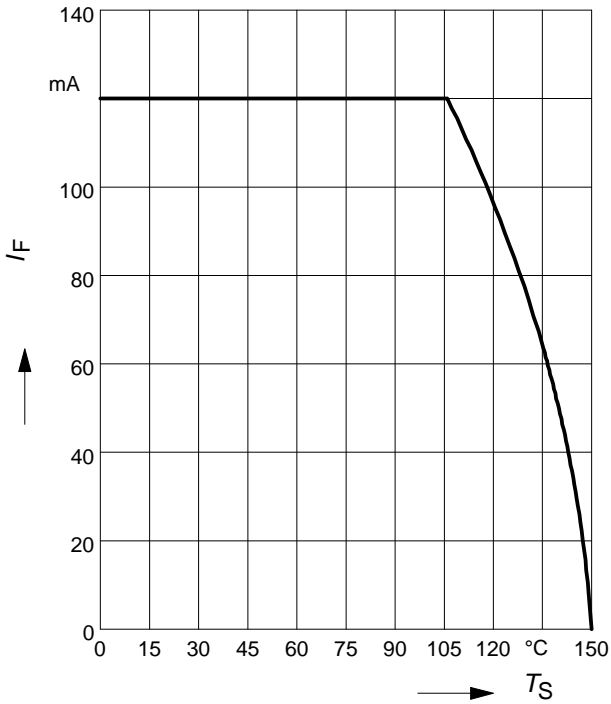

Forward current  $I_F = f(T_S)$

BAS40-05

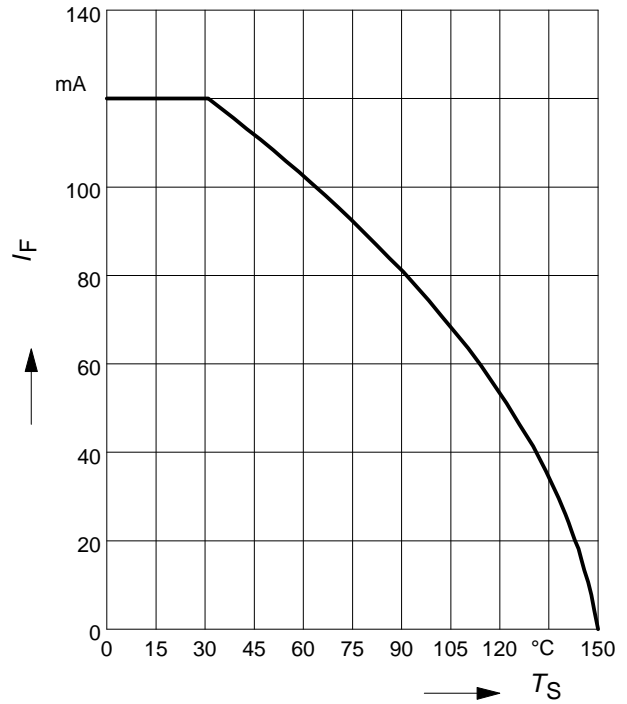

Forward current  $I_F = f(T_S)$

BAS40-05W

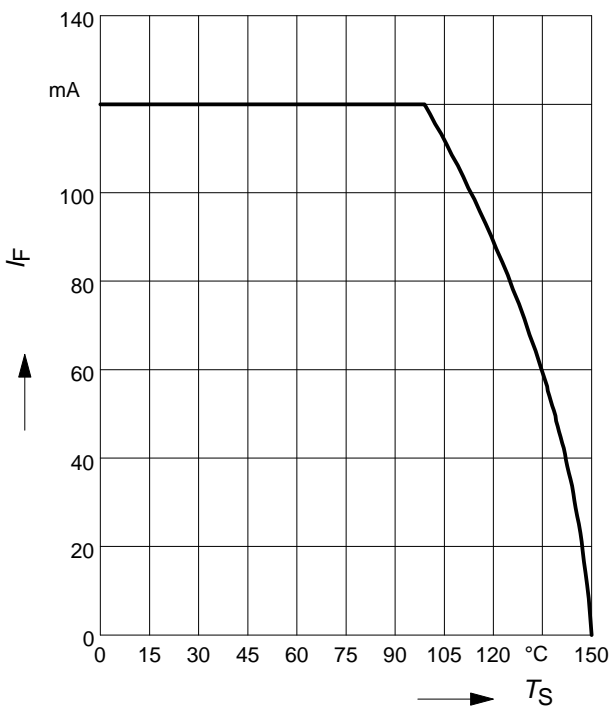

Forward current  $I_F = f(T_S)$

BAS40-07W

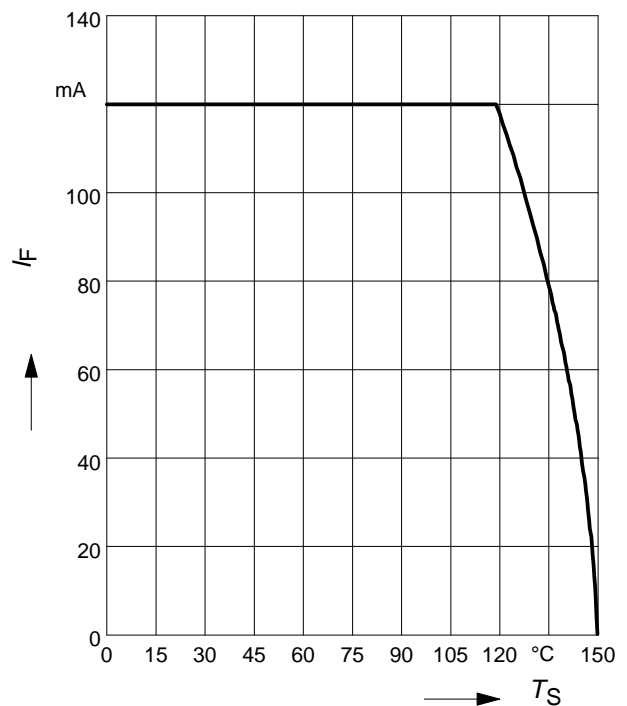

**Permissible Puls Load  $R_{thJS} = f(t_p)$**

BAS140W

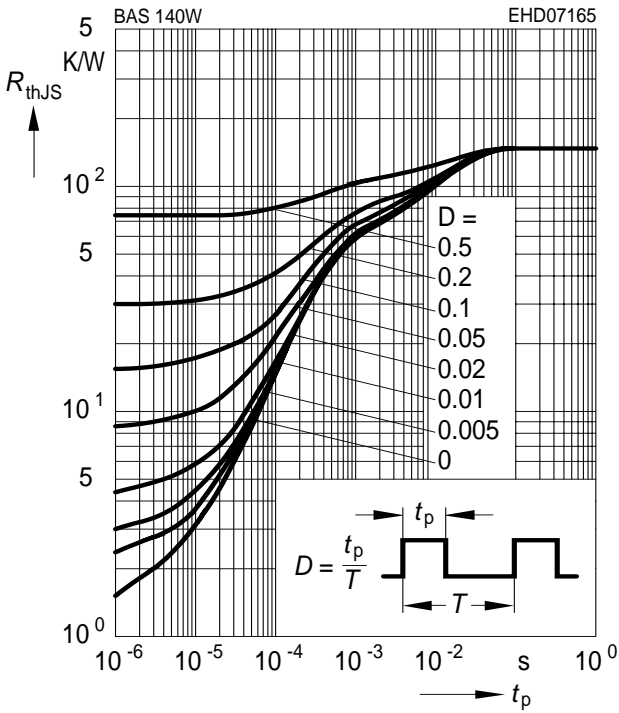

**Permissible Pulse Load**

$I_{Fmax} / I_{FDC} = f(t_p)$

BAS140W

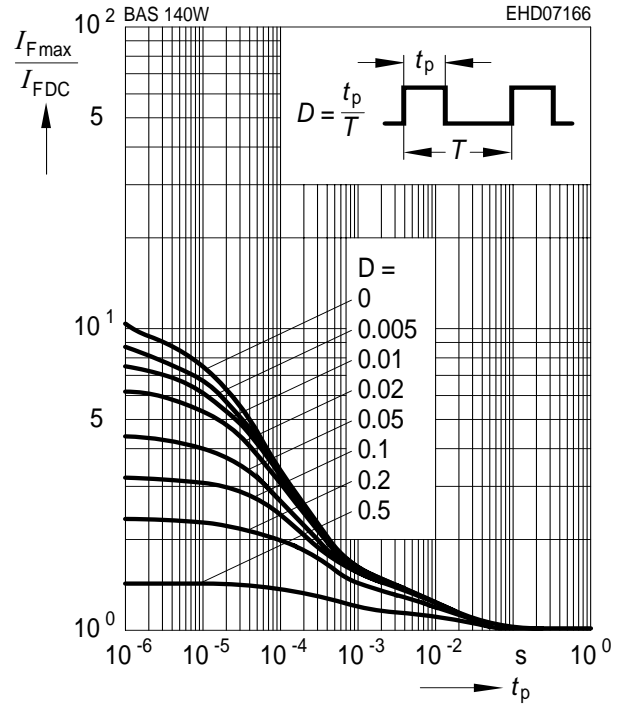

**Permissible Puls Load  $R_{thJS} = f(t_p)$**

BAS40-02L

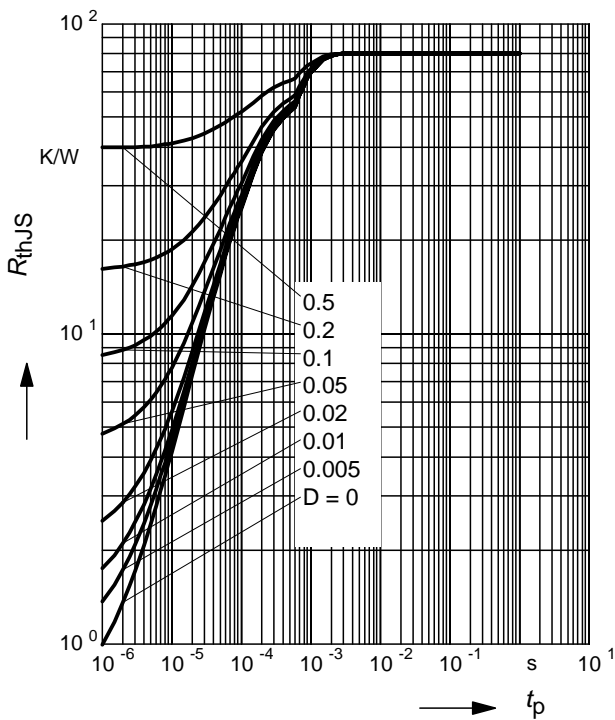

**Permissible Pulse Load**

$I_{Fmax} / I_{FDC} = f(t_p)$

BAS40-02L

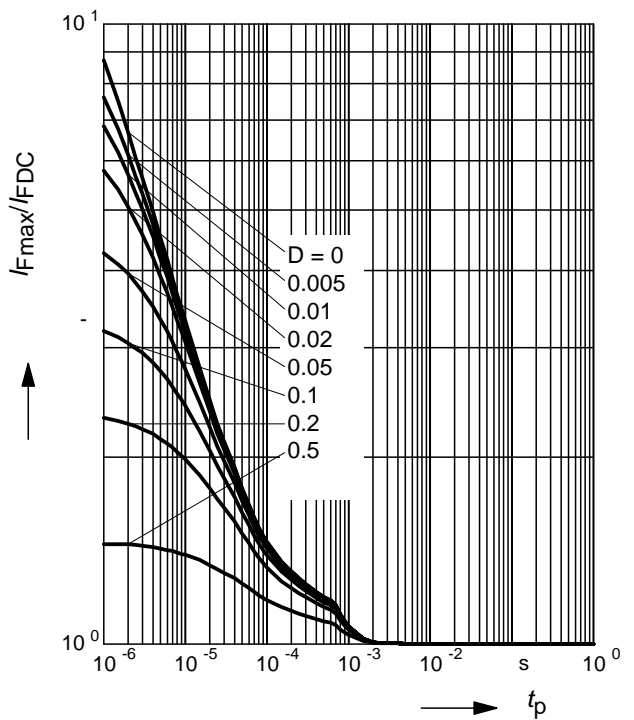

**Permissible Puls Load  $R_{thJS} = f(t_p)$**

BAS40-06W

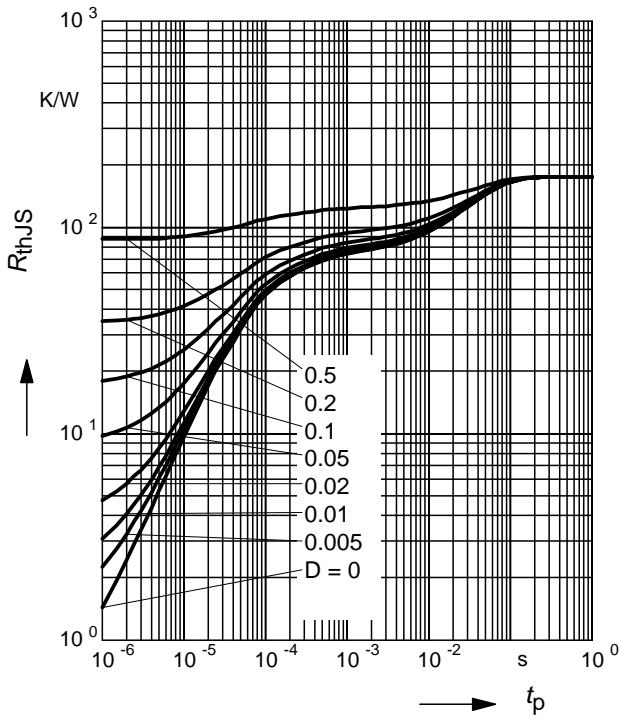

**Permissible Pulse Load**

$I_{Fmax} / I_{FDC} = f(t_p)$

BAS40-06W

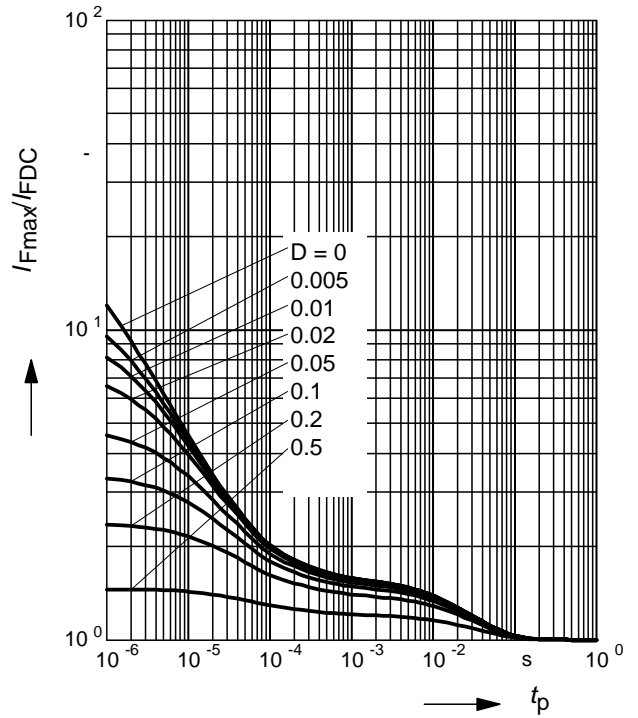

**Permissible Puls Load  $R_{thJS} = f(t_p)$**

BAS40-05W

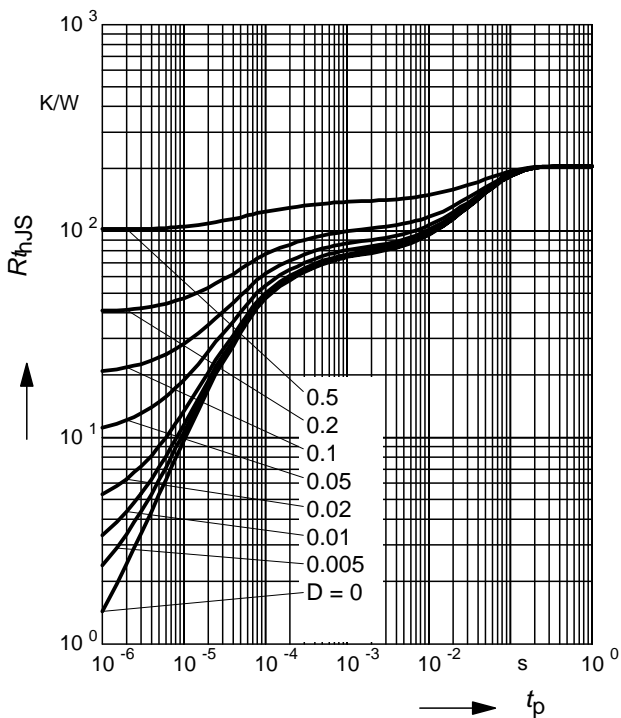

**Permissible Pulse Load**

$I_{Fmax} / I_{FDC} = f(t_p)$

BAS40-05W

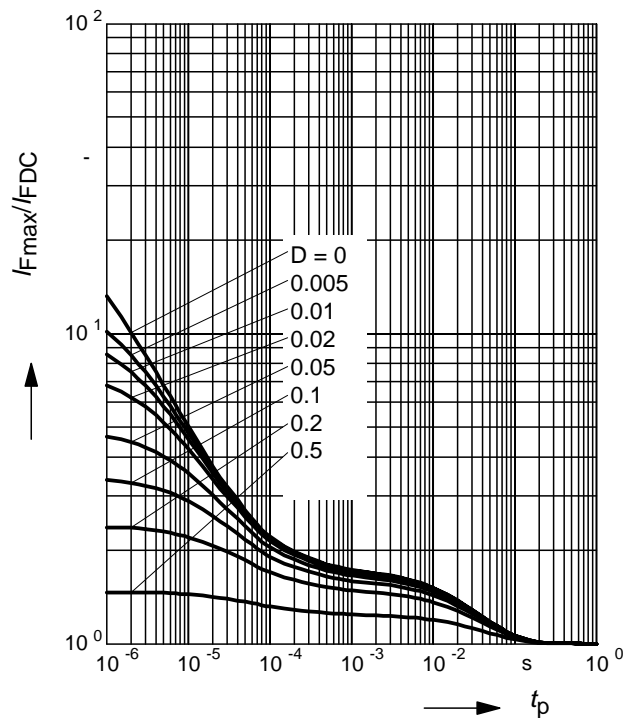



### Package Outline

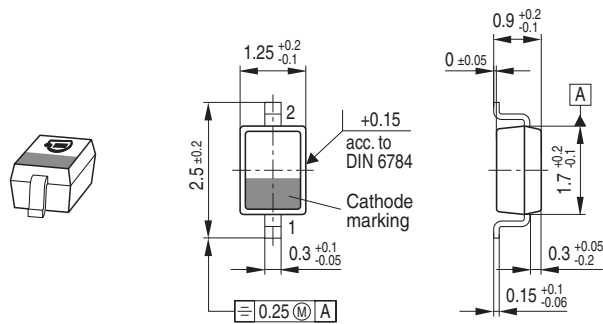

### Foot Print

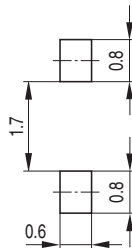

### Marking Layout

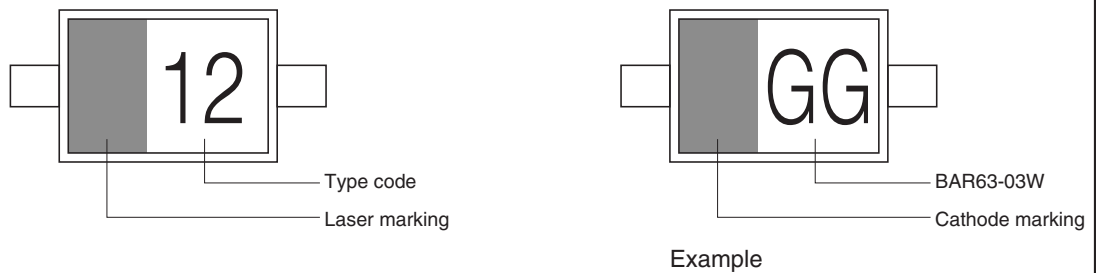

### Packing

Code E6327: Reel  $\varnothing$ 180 mm = 3.000 Pieces/Reel  
 Code E6433: Reel  $\varnothing$ 330 mm = 10.000 Pieces/Reel

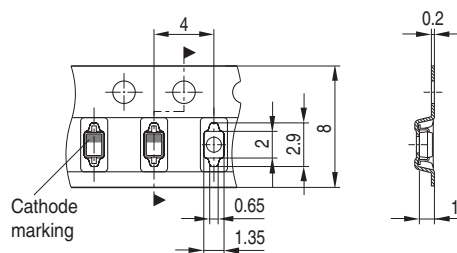

### Package Outline

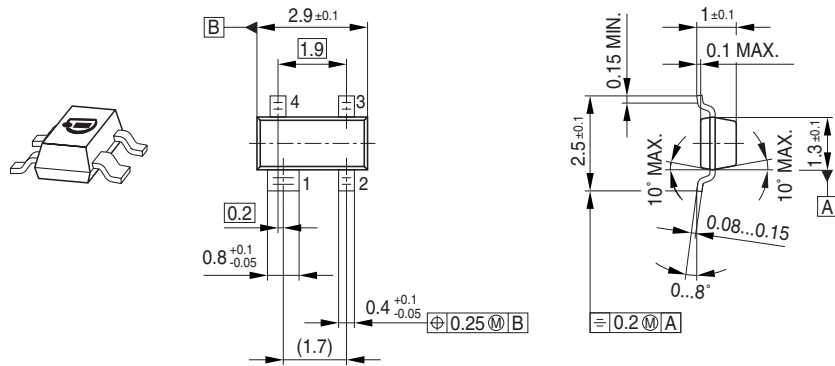

### Foot Print

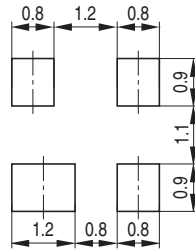

### Marking Layout

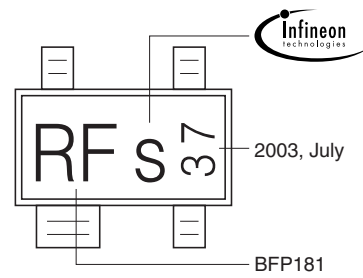
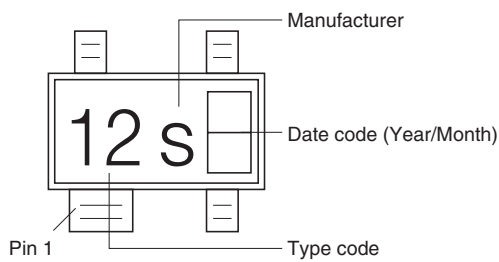

Example

### Packing

Code E6327: Reel  $\varnothing 180$  mm = 3.000 Pieces/Reel  
 Code E6433: Reel  $\varnothing 330$  mm = 10.000 Pieces/Reel

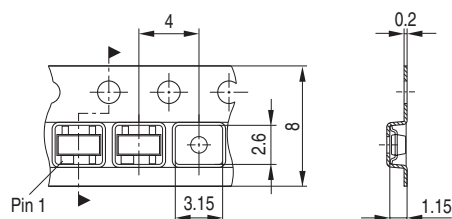

### Package Outline

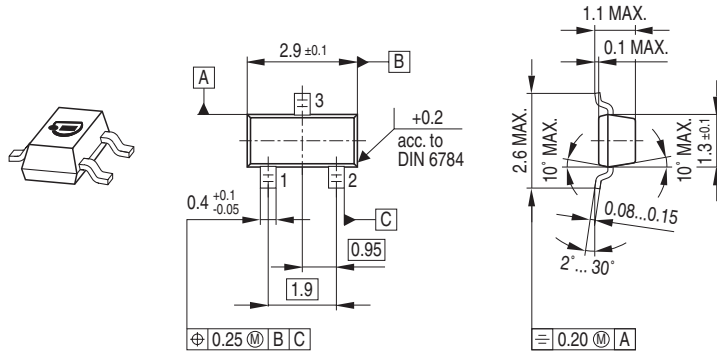

### Foot Print

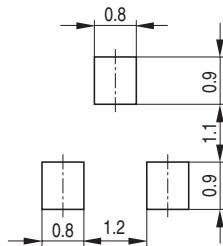

### Marking Layout

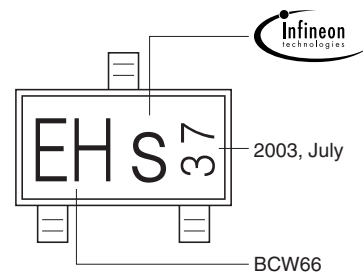
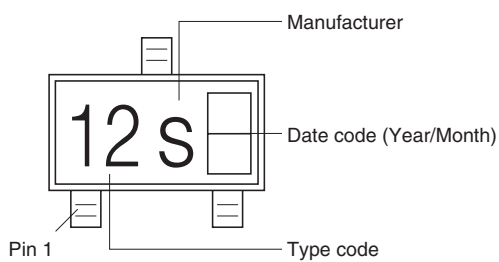

Example

### Packing

Code E6327: Reel  $\varnothing$ 180 mm = 3.000 Pieces/Reel

Code E6433: Reel  $\varnothing$ 330 mm = 10.000 Pieces/Reel

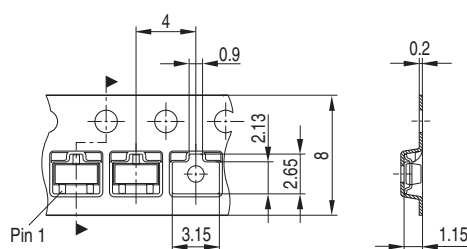

Package Outline

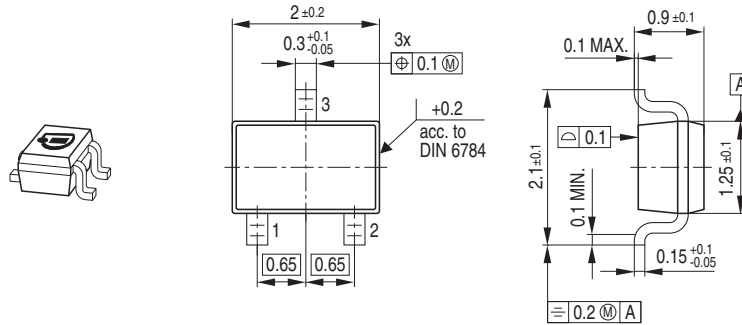

Foot Print

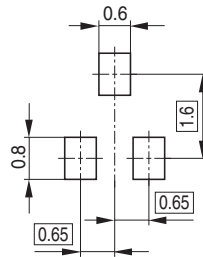

Marking Layout

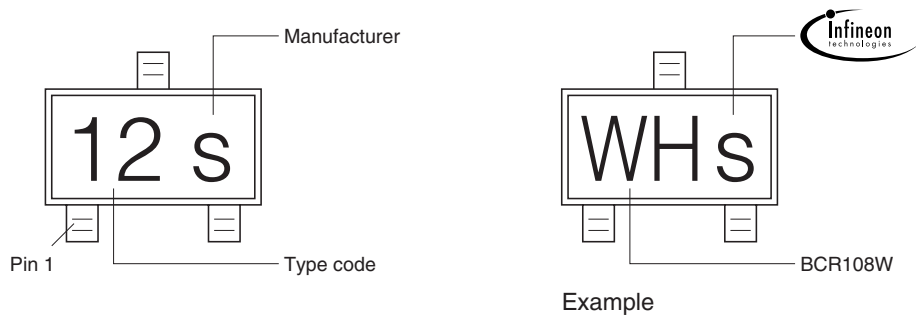

Packing

Code E6327: Reel ø180 mm = 3.000 Pieces/Reel  
 Code E6433: Reel ø330 mm = 10.000 Pieces/Reel

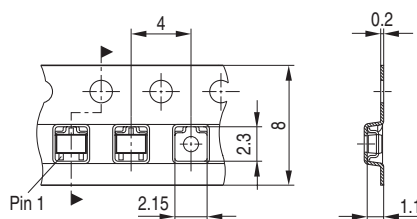

### Package Outline

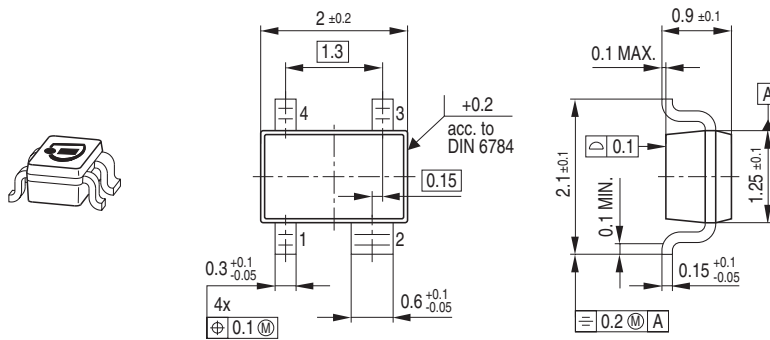

### Foot Print

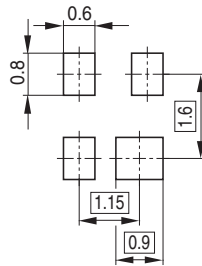

### Marking Layout

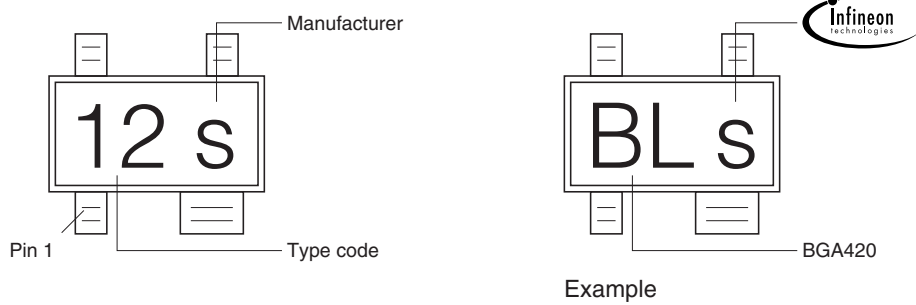

### Packing

Code E6327: Reel  $\varnothing$ 180 mm = 3.000 Pieces/Reel  
 Code E6433: Reel  $\varnothing$ 330 mm = 10.000 Pieces/Reel

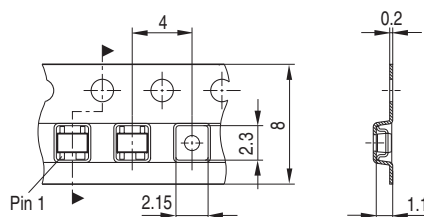



Published by Infineon Technologies AG,  
St.-Martin-Strasse 53,  
81669 München  
© Infineon Technologies AG 2005.  
All Rights Reserved.

### **Attention please!**

The information herein is given to describe certain components and shall not be considered as a guarantee of characteristics.

Terms of delivery and rights to technical change reserved.

We hereby disclaim any and all warranties, including but not limited to warranties of non-infringement, regarding circuits, descriptions and charts stated herein.

### **Information**

For further information on technology, delivery terms and conditions and prices please contact your nearest Infineon Technologies Office ([www.infineon.com](http://www.infineon.com)).

### **Warnings**

Due to technical requirements components may contain dangerous substances. For information on the types in question please contact your nearest Infineon Technologies Office.

Infineon Technologies Components may only be used in life-support devices or systems with the express written approval of Infineon Technologies, if a failure of such components can reasonably be expected to cause the failure of that life-support device or system, or to affect the safety or effectiveness of that device or system. Life support devices or systems are intended to be implanted in the human body, or to support and/or maintain and sustain and/or protect human life. If they fail, it is reasonable to assume that the health of the user or other persons may be endangered.