

## SUPER FAST RECTIFIER

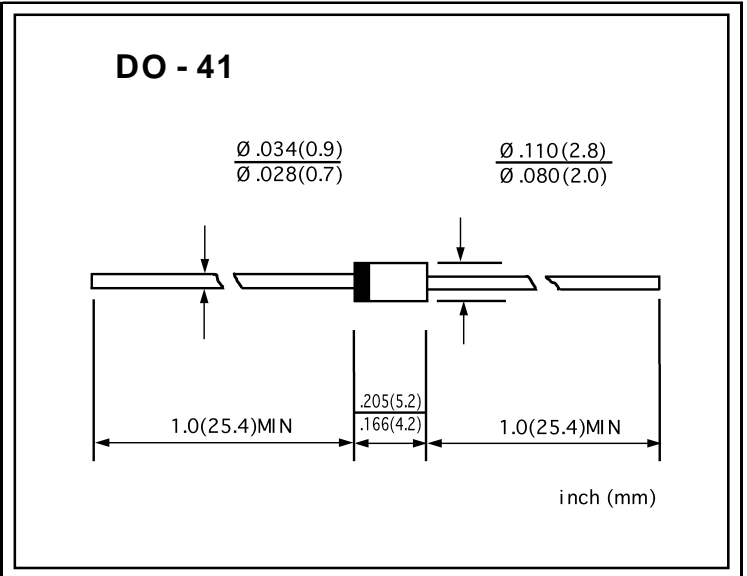
VOLTAGE RANGE: 50 --- 600 V  
CURRENT: 1.0 A

### FEATURES

- ◇ Low cost
- ◇ Low leakage
- ◇ Low forward voltage drop
- ◇ High current capability
- ◇ Easily cleaned with alcohol, Isopropanol and similar solvents
- ◇ The plastic material carries U/L recognition 94V-0

### MECHANICAL DATA

- ◇ Case: JEDEC DO-41, molded plastic
- ◇ Terminals: Axial lead, solderable per MIL-STD-202, Method 208
- ◇ Polarity: Color band denotes cathode
- ◇ Weight: 0.012 ounces, 0.34 grams
- ◇ Mounting position: Any



### MAXIMUM RATINGS AND ELECTRICAL CHARACTERISTICS

Ratings at 25°C ambient temperature unless otherwise specified.

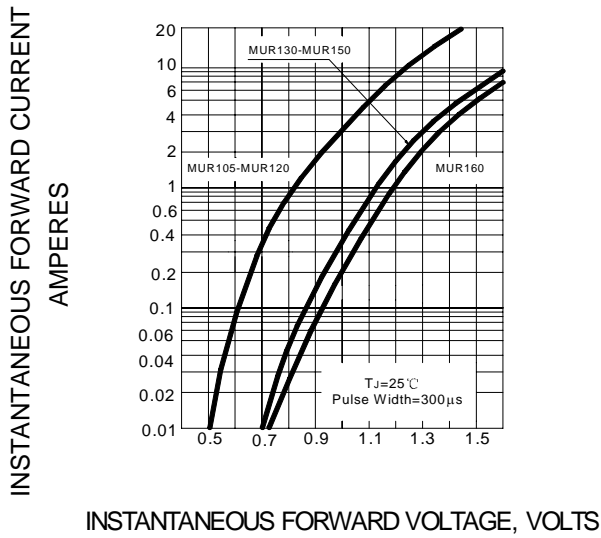
Single phase, half wave, 60 Hz, resistive or inductive load. For capacitive load, derate by 20%.

		MUR 105	MUR 110	MUR 115	MUR 120	MUR 130	MUR 140	MUR 150	MUR 160	UNITS
Maximum recurrent peak reverse voltage	$V_{RRM}$	50	100	150	200	300	400	500	600	V
Maximum RMS voltage	$V_{RMS}$	35	70	105	140	210	280	350	420	V
Maximum DC blocking voltage	$V_{DC}$	50	100	150	200	300	400	500	600	V
Maximum average forward rectified current 9.5mm lead length, @ $T_A=75^\circ C$	$I_{F(AV)}$	1.0								A
Peak forward surge current 8.3ms single half-sine-wave superimposed on rated load @ $T_J=125^\circ C$	$I_{FSM}$	35.0								A
Maximum instantaneous forward voltage @ 1.0A	$V_F$	0.875			1.2			1.25		V
Maximum reverse current @ $T_A=25^\circ C$ at rated DC blocking voltage @ $T_A=100^\circ C$	$I_R$	10.0 100.0								$\mu A$
Maximum reverse recovery time (Note1)	$t_{rr}$	25			50					ns
Typical junction capacitance (Note2)	$C_J$	22								pF
Typical thermal resistance (Note3)	$R_{\theta JA}$	50								$^\circ C/W$
Operating junction temperature range	$T_J$	- 55 ----- + 150								$^\circ C$
Storage temperature range	$T_{STG}$	- 55 ----- + 150								$^\circ C$

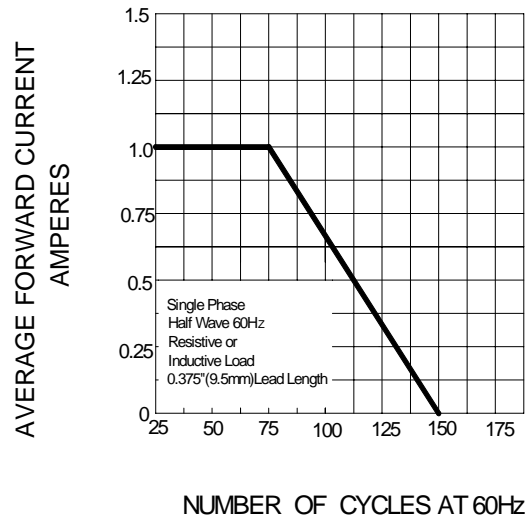
NOTE: 1. Measured with  $I_F=0.5A$ ,  $I_R=1A$ ,  $I_{rr}=0.25A$ .  
2. Measured at 1.0MHz and applied reverse voltage of 4.1V DC.  
3. Thermal resistance from junction to ambient.

www.galaxycn.com

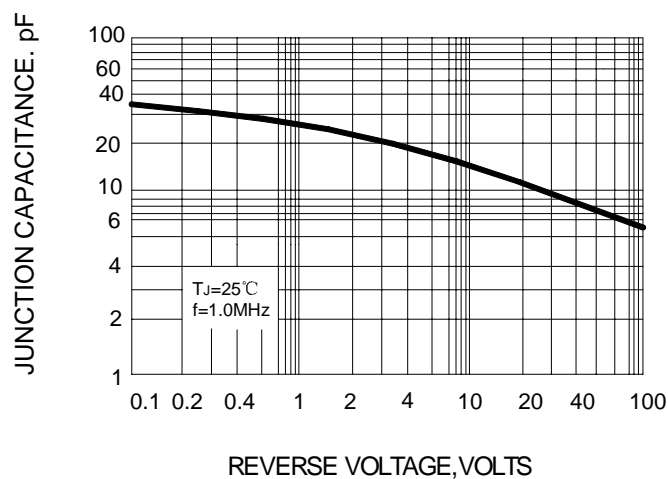
**FIG.1 – TYPICAL FORWARD CHARACTERISTICS**



**FIG.2 – FORWARD DRATING CURVE**

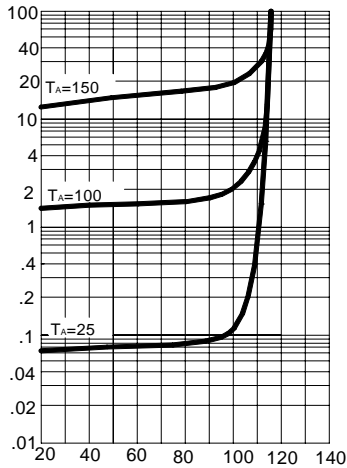


**FIG.3 – TYPICAL JUNCTION CAPACITANCE**



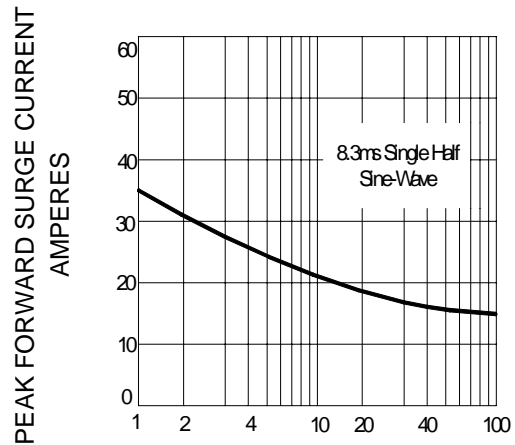
INSTANTANEOUS REVERSE LEAKAGE CURRENT  
MICRO AMPERES

**FIG.4 – TYPICAL REVERSE CHARACTERISTICS**



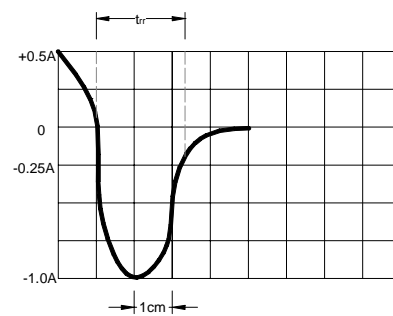
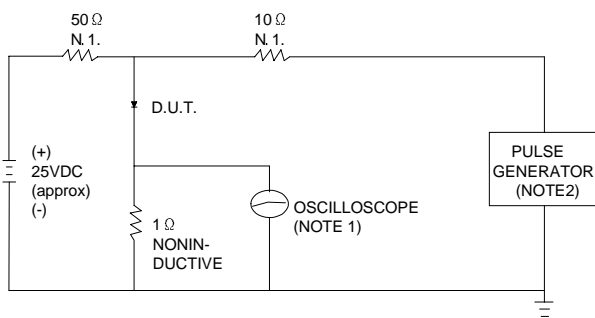
PERCENT OF RATED PEAK REVERSE VOLTAGE, %

**FIG.5 – PEAK FORWARD SURGE CURRENT**



NUMBER OF CYCLES AT 60Hz

**FIG.6 – TEST CIRCUIT DIAGRAM AND REVERSE RECOVERY TIME CHARACTERISTIC**



NOTES: 1. RISE TIME = 7ns MAX INPUT IMPEDANCE = 1MΩ .22pF.  
2. RISE TIME = 10ns MAX SOURCE IMPEDANCE = 50Ω.

SET TIME BASE FOR 10/20 ns/cm