

LEADED DEVICES

Plastic passivated junction rectifier

Leaded Devices

MERITEK

GENERAL PURPOSE RECTIFIER

PRV(V) TYPE NO Io(A)	50	100	200	300	400	500	600	800	1000	1250	1300	1600	PACKAGE
1.0	1A1	1A2	1A3		1A4		1A5	1A6	1A7				R-1
1.0	1N4001S	1N4002S	1N4003S		1N4004S		1N4005S	1N4006S					A-405
1.0	1N4001	1N4002	1N4003		1N4004		1N4005	1N4006					DO-41
1.0										BY127M	BY133	EM513	DO-41
1.5	1N5391	1N5392	1N5393	1N5394	1N5395	1N5396	1N5397	1N5398	1N5399				DO-15
1.5	RL151	RL152	RL153		RL154		RL155	RL156	PS157				DO-15
2.0	RL201	RL202	RL203		RL204		RL205	RL206	RL207				DO-15
3.0	1N5400	1N5401	1N5402	1N5403	1N5404	1N5405	1N5406	1N5407	1N5408				DO-201AD
3.0			BY251		BY252		BY253	BY254			BY255		
6.0	P600A	P600B	P600D		P600G		P600J	P600K	P600M				P600

FAST RECOVERY RECTIFIER

PRV(V) TRR(NS) TYPE NO Io(A)	50 150	100 150	200 150	400 150	600 250	800 500	1000 500	PACKAGE
1.0	1F1	1F2	1F3	1F4	1F5	1F6	1F7	R-1
1.0	1N4001SF	1N4002SF	1N4003SF	1N4004SF	1N4004SF	1N4006SF	1N4007SF	A-405
1.0	FR101	FR102	FR103	FR104	FR105	FR106	FR107	DO-41
1.0	1N4933	1N4933A	1N4935	1N4936	1N4937			DO-41
1.0			1N4942	1N4944	1N4946	1N4947	1N4948	DO-41
1.0				BA157	BA158		BA159	DO-41
1.5	FR151	FR152	FR153	FR154	FR155	FR156	FR157	DO-15
2.0	FR201	FR202	FR203	FR204	FR205	FR206	FR207	DO-15
2.0		BY296	BY297	BY298		BY299		DO-201AD
3.0	FR301	FR302	FR303	FR304	FR305	FR306	FR307	DO-201AD
3.0		BY396	BY397	BY398		BY399		DO-201AD
3.0	MR850	MR851	MR852	MR854	MR856			DO-201AD
6.0	FR601	FR602	FR603	FR604	FR605	FR606		P600

ULTRA FAST RECOVERY RECTIFIER

PRV(V) TRR(NS) TYPE NO Io(A)	50 50	100 50	200 50	400 50	600 75	800 75	1000 75	PACKAGE
1.0	1U1	1U2	1U3	1U4	1U5	1U6	1U7	R-1
1.0	UF4001S	UF4002S	UF4003S	UF4004S	UF4005S	UF4006S	UF4007S	A-405
1.0	UF4001	UF4002	UF4003	UF4004	UF4005	UF4006	UF4007	DO-41
1.5	HER151	HER152	HER153	HER154	HER155	HER156	HER157	DO-15
2.0	HER201	HER202	HER203	HER204	HER205	HER206	HER207	DO-15
3.0	HER301	HER302	HER303	HER304	HER305	HER306	HER307	DO-201AD
6.0	HER601	HER602	HER603	HER604	HER605	HER606	HER607	P600

GLASS PASSIVATED JUNCTION RECTIFIER

GENERAL PURPOSE RECTIFIER

PRV(V) TYPE NO Io(A)	50	100	200	400	600	800	1000	PACKAGE
1.0	1A1G	1A2Gg	1A3G	1A4G	1A5G	1A6G	1A7G	R-1
1.0	1N4001GS	1N4002GS	1N4003GS	1N4004GS	1N4005GS	1N4006GS		A-405
1.0	1N4001G	1N4002G	1N4003G	1N4004G	1N4005G	1N4006G		DO-41

ULTRA FAST RECOVERY RECTIFIER

PRV(V) TRR(NS) TYPE NO Io(A)	50	100	200	300	400	600	800	PACKAGE
8.0	UF800F	UF801F	UF802F	UF803F	UF804F	UF806F	UF808F	ITO-220AC
8.0	UF800	UF801	UF802	UF803	UF804	UF806	UF808	TO-220AC
10.0	UF1000F	UF1001F	UF1002F		UF1004F	UF1006F	UF1008F	ITO-220AC
10.0	UF1000	UF1001	UF1002		UF1004	UF1006	UF1008	TO-220AC
16.0	UF1600F	UF1601F	UF1602F	UF16003F	UF1604F	UF1606F	UF1608F	ITO-220AB
16.0	UF1600	UF1601	UF1602	UF16003	UF1604	UF1606	UF1608	TO-220AB

SUPER FAST RECOVERY RECTIFIER

PRV(V) TRR(NS) TYPE NO Io(A)	50	100	150	200	300	400	600	PACKAGE
1.0	1E1	1E2	1E2A	1E3	1E3A	1E4	1E5	R-1
1.0	SF11S	SF12S	SF13S	SF14S	SF15S	SF16S	SF17S	A-405
1.0	SF11	SF12	SF13	SF14	SF15	SF16	SF17	DO-41
2.0	SF21	SF22	SF23	SF24	SF25	SF26	SF27	DO-15
3.0	SF31	SF32	SF33	SF34	SF35	SF36	SF37	DO-201AD
5.0	SF51	SF52	SF53	SF54	SF55	SF56	SF57	DO-201AD
8.0	ER800F	ER801F	ER801AF	ER802F	ER803F	ER804F		ITO-220AC
8.0	ER800	ER801	ER801A	ER802	ER803	ER804		TO-220AC
10.0	ER100F	ER1001F	ER1001AF	ER1002F	ER1003F	ER1004F		ITO-220AC
10.0	ER1000	ER1001	ER1001A	ER1002	ER1003	ER1004		TO-220AC
16.0	ER1600F	ER1601F	ER1601AF	ER1602F	ER1603F	ER1604F		ITO-220AB
16.0	ER1600	ER1601	ER1601A	ER1602	ER1603	ER1604		TO-220AB

SURFACE MOUNT DEVICES

GENERAL PURPOSE RECTIFIER

PRV(V) TYPE NO Io(A)	50	100	200	400	600	800	1000	PACKAGE
1.0	GS1A	GS1B	GS1D	GS1G	GS1J	GS1K	GS1M	SMA/DO-214AC
1.0	S1A	S1B	S1D	S1G	S1J	S1K	S1M	SMB/DO-214AA
2.0	S2A	S2B	S2D	S2G	S2J	S2K	S2M	SMB/DO-214AA
3.0	S3A	S3B	S3D	S3G	S3J	S3K	S3M	SMC/DO-214AB

FAST RECOVERY RECTIFIER

PRV(V) TYPE NO TRR(NS) Io(A)	50 150	100 150	200 150	400 150	600 250	800 500	PACKAGE
1.0	RS1A	RS1B	RS1D	RS1G	RS1J	S1K	SMA/DO-214AC
1.0	FR1A	FR1B	FR1D	FR1G	FR1J	FR1K	SMB/DO-214AA
2.0	FR2A	FR2B	FR2D	FR2G	FR2J	FR2K	SMB/DO-214AA
3.0	FR3A	FR3B	FR3D	FR3G	FR3J	FR3K	SMC/DO-214AB

ULTRA FAST RECOVERY RECTIFIER

PRV(V) TYPE NO TRR(NS) Io(A)	50 150	100 150	200 150	400 150	600 250	800 500	PACKAGE
1.0	US1A	US1B	US1D	US1G	US1J	US1K	SMA/DO-214AC
1.0	UF1A	UF1B	UF1D	UF1G	UF1J	UF1K	SMB/DO-214AA
2.0	UF2A	UF2B	UF2D	UF2G	UF2J	UF2K	SMB/DO-214AA
3.0	UF3A	UF3B	UF3D	UF3G	UF3J	UF3K	SMC/DO-214AB

SUPER FAST RECOVERY RECTIFIER

PRV(V) TYPE NO TRR(NS) Io(A)	50 35	100 35	150 35	200 35	300 35	400 35	600 35	PACKAGE
1.0	ES1A	ES1B	ES1C	ES1D	ES1E	ES1G	ES1J	SMA/DO-214AC
1.0	ER1A	ER1B	ER1C	ER1D	ER1E	ER1G	ER1J	SMB/DO-214AA
2.0	ER2A	ER2B	ER2C	ER2D	ER2E	ER2G	ER2J	SMB/DO-214AA
3.0	ER3A	ER3B	ER3C	ER3D	ER3E	ER3G	ER3J	SMC/DO-214AB
3.0				ED302S	ED303S	EDS304S	ED306S	D PAK/TO-252
6.0				ED602CS	ED603CS	ED604CS	ED606CS	D PAK/TO-252
8.0				ED802CS	ED803CS	ED804CS	ED806CS	D PAK/TO-252

ZENER DIODE

PD(W) PACKAGE TYPE NO VZ(V)	0.35		0.5		1			1.5	
	SOT-23	MINI-MELF	DO-35	DL-41 (MELF)	SMA DO-214AC	DO-41	SMB DO-214AA	DO-41	
2.4	MMBZ5221B	MLL5221B	1N5221B						
2.5	MMBZ5222B	MLL5222B	1N5222B						
2.7	MMBZ5223B	MLL5223B	1N5223B						
2.8	MMBZ5224B	MLL5224B	1N5224B						
3.0	MMBZ5225B	MLL5225B	1N5225B						
3.3	MMBZ5226B	MLL5226B	1N5226B	DL4728A		1N4728A			
3.6	MMBZ5227B	MLL5227B	1N5227B	DL4729A		1N4729A			
3.9	MMBZ5228B	MLL5228B	1N5228B	DL4730A		1N4730A			
4.3	MMBZ5229B	MLL5229B	1N5229B	DL4731A		1N4731A			
4.7	MMBZ5230B	MLL5230B	1N5230B	DL4732A		1N4732A			
5.1	MMBZ5231B	MLL5231B	1N5231B	DL4733A		1N4733A			
5.6	MMBZ5232B	MLL5232B	1N5232B	DL4734A		1N4734A			
6.0	MMBZ5233B	MLL5233B	1N5233B						
6.2	MMBZ5234B	MLL5234B	1N5234B	DL4735A		1N4735A			
6.8	MMBZ5235B	MLL5235B	1N5235B	DL4736A		1N4736A			
7.5	MMBZ5236B	MLL5236B	1N5236B	DL4737A		1N4737A			
8.2	MMBZ5237B	MLL5237B	1N5237B	DL4738A		1N4738A			
8.7	MMBZ5238B	MLL5238B	1N5238B						
9.1	MMBZ5239B	MLL5239B	1N5239B	DL4739A		1N4739A			
10	MMBZ5240B	MLL5240B	1N5240B	DL4740A		1N4740A			
11	MMBZ5241B	MLL5241B	1N5241B	DL4741A	1SMA4741	1N4741A	1SMB5926	1N5926B	
12	MMBZ5242B	MLL5242B	1N5242B	DL4742A	1SMA4742	1N4742A	1SMB5927	1N5927B	
13	MMBZ5243B	MLL5243B	1N5243B	DL4743A	1SMA4743	1N4743A	1SMB5928	1N5928B	
14	MMBZ5244B	MLL5244B	1N5244B						
15	MMBZ5245B	MLL5245B	1N5245B	DL4744A	1SMA4744	1N4744A	1SMB5929	1N5929B	
16	MMBZ5246B	MLL5246B	1N5246B	DL4745A	1SMA4745	1N4745A	1SMB5930	1N5930B	
17	MMBZ5247B	MLL5247B	1N5247B						
18	MMBZ5248B	MLL5248B	1N5248B	DL4746A	1SMA4746	1N4746A	1SMB5931	1N5931B	
19	MMBZ5249B	MLL5249B	1N5249B						
20	MMBZ5250B	MLL5250B	1N5250B	DL4747A	1SMA4747	1N4747A	1SMB5932	1N5932B	
22	MMBZ5251B	MLL5251B	1N5251B	DL4748A	1SMA4748	1N4748A	1SMB5933	1N5933B	
24	MMBZ5252B	MLL5252B	1N5252B	DL4749A	1SMA4749	1N4749A	1SMB5934	1N5934B	
25	MMBZ5253B	MLL5253B	1N5253B						
27	MMBZ5254B	MLL5254B	1N5254B	DL4750A	1SMA4750	1N4750A	1SMB5935	1N5935B	
28	MMBZ5255B	MLL5255B	1N5255B						
30	MMBZ5256B	MLL5256B	1N5256B	DL4751A	1SMA4751	1N4751A	1SMB5936	1N5936B	
33	MMBZ5257B	MLL5257B	1N5257B	DL4752A	1SMA4752	1N4752A	1SMB5937	1N5937B	
36	MMBZ5258B	MLL5258B	1N5258B	DL4753A	1SMA4753	1N4753A	1SMB5938	1N5938B	
39	MMBZ5259B	MLL5259B	1N5259B	DL4754A	1SMA4754	1N4754A	1SMB5939	1N5939B	
43		MLL5260B	1N5260B	DL4755A	1SMA4755	1N4755A	1SMB5940	1N5940B	
47		MLL5261B	1N5261B	DL4756A	1SMA4756	1N4756A	1SMB5941	1N5941B	
51				DL4757A	1SMA4757	1N4757A	1SMB5942	1N5942B	
56				DL4758A	1SMA4758	1N4758A	1SMB5943	1N5943B	
60									
62				DL4759A	1SMA4759	1N4759A	1SMB5944	1N5944B	
68				DL4760A	1SMA4760	1N4760A	1SMB5945	1N5945B	
75				DL4761A	1SMA4761	1N4761A	1SMB5946	1N5946B	
82				DL4762A	1SMA4762	1N4762A	1SMB5947	1N5947B	
87									
91				DL4763A	1SMA4763	1N4763A	1SMB5948	1N5948B	
100				DL4764A	1SMA4764	1N4764A	1SMB5949	1N5949B	
110					1SMA110Z	1M110Z	1SMB5950	1N5950B	
120					1SMA120Z	1M120Z	1SMB5951	1N5951B	
130					1SMA130Z	1M130Z	1SMB5952	1N5952B	
150					1SMA150Z	1M150Z	1SMB5953	1N5953B	
160					1SMA160Z	1M160Z	1SMB5954	1N5954B	
180					1SMA180Z	1M180Z	1SMB5955	1N5955B	
200					1SMA200Z	1M200Z	1SMB5956	1N5956B	

SCHOTTKY BARRIER RECTIFIER

LEADED DEVICES

PRV(V) TYPE NO Io(A)	20	30	40	50	60	80	100	PACKAGE
1.0	1S2	1S3	1S4	1S5	1S6	1S8	1S10	R-1
1.0	SB120S	SB130S	SB140S	SB150S	SB160S	SB180S	SB1100S	A-405
1.0	1N5817	1N5818	1N5819					DO-41
1.0	SB120	SB130	SB140	SB150	SB160	SB180	SB1100	DO-41
2.0	SB220	SB230	SB240	SB250	SB260	SB280	SB2100	DO-15
3.0	1N5820	1N5821	1N5822					DO-201AD
3.0	SB320	SB330	SB340	SB350	SB360	SB380	SB3100	DO-201AD
5.0	SB520	SB530	SB540	SB550	SB560	SB580	SB5100	DO-201AD
8.0	SB820F	SB830F	SB840F	SB850F	SB860F	SB880F	SB8100F	ITO-220AC
8.0	SB820	SB830	SB840	SB850	SB860	SB880	SB8100	TO-220AC
10.0	SB1020F	SB1030F	SB1040F	SB1050F	SB1060F	SB1080F	SB10100F	ITO-220AC
10.0	SB1020	SB1030	SB1040	SB1050	SB1060	SB1080	SB10100	TO-220AC
16.0	SB1620F	SB1630F	SB1640F	SB1650F	SB1660F	SB1680F	SB16100F	ITO-220AB
16.0	SB1620	SB1630	SB1640	SB1650	SB1660	SB1680	SB16100	TO-220AB

SURFACE MOUNT DEVICES

PRV(V) TYPE NO Io(A)	20	30	40	50	60	80	90	100	PACKAGE
1.0	SS12	SS13	SS14	SS15	SS16	SS18	SS19	S100	SAM/DO-214AC
1.0	SL12	SL13	SL14						SMA/DO-214AC
1.0	SK12	SK13	SK14	SK15	SK16	SK18	SK19	S110	SMB/DO-214AA
2.0	SR22	SR23	SR24	SR25	SR26	SR28	SR29		SMA/DO-214AC
2.0	SK22	SK23	SK24	SK25	SK26	SK28	SK29	S210	SMB/DO-214AA
2.0	SL22	SL23	SL24						SMB/DO-214AA
3.0	SK32	SK33	SK34	SK35	SK36	SK38	SK39	S310	SMC/DO-214AB
3.0	SR32	SR33	SR34	SR35	SR36	SR38	SR39		SMB/DO-214AA
3.0	SL32	SL33	SL34						SMC/DO-214AB
3.0	SD320S	SD330S	SD340S	SD350S	SD360S	SD380S		SD3100S	D PAK/TO-252
6.0	SD620CS	SD630CS	SD640CS	SD650CS	SD660CS	SD680CS		SD6100CS	D PAK/TO-252
8.0	SD820S	SD830S	SD840S	SD850S	SD860S	SD880S		SD8100S	DPACK/TO-252
16.0	SB1620DC	SB1630DC	SB1640DC	SB1650DC	SB1660DC	SB1680DC		SB16100DC	D2PAK/TO-263

BRIDGE RECTIFIER

LEADED DEVICES

PRV(V) TYPE NO Io(A)	50	100	200	400	600	800	1000	PACKAGE
1.0	DI100	DI101	DI102	DI104	DI106	DI108	DI1010	DIP
1.5	DI150	DI151	DI152	DI154	DI156	DI158	DI1510	DIP
1.5	W005G	W01G	W02G	W04G	W06G	W08G	W010G	AM
1.5	KBP005M	KBP01M	KBP02M	KBP04M	KBP06M	KBP08M	KBP010M	KBPM
2.0	2KBP005M	2KBP01M	2KBP02M	2KBP04M	2KBP06M	2KBP08M	2KBP010M	KBPM
3.0	CP300	CP301	CP302	CP304	CP306	CP308	CP3010	CP-3
4.0	KBL005	KBL01	KBL02	KBL04	KBL06	KBL08	KBL010	KBL
4.0	KBU4A	KBU4B	KBU4D	KBU4G	KBU4J	KBU4K		KBU
4.0	GBU4A	GBU4B	GBU4D	GBU4G	GBU4J	GBU4K		GBU
6.0	KBU6A	KBU6B	KBU6D	KBU6G	KBU6J	KBU6K		KBU
6.0	GBU6A	GBU6B	GBU6D	GBU6G	GBU6J	GBU6K		GBU
6.0	KBPC600	KBPC601	KBPC602	KBPC604	KBPC606	KBPC608		KBPC-6
8.0	KBU8A	KBU8B	KBU8D	KBU8G	KBU8J	KBU8K		KBU
8.0	GBU8A	GBU8B	GBU8D	GBU8G	GBU8J	GBU8K		GBU
8.0	KBPC800	KBPC801	KBPC802	KBPC804	KBPC806	KBPC808		KBPCP-8
10.0	CP1000	CP1001	CP1002	CP1004	CP1006	CP1008		CP-10
10.0	KBPC1000(W)	KBPC1001(W)	KBPC1002(W)	KBPC1004(W)	KBPC1006(W)	KBPC1008(W)		KBPC(W)
15.0	KBPC1500(W)	KBPC1501(W)	KBPC1502(W)	KBPC1504(W)	KBPC1506(W)	KBPC1508(W)		KBPC(W)
25.0	KBPC2500(W)	KBPC2501(W)	KBPC2502(W)	KBPC2504(W)	KBPC2506(W)	KBPC2508(W)		KBPC(W)
35.0	KBPC3500(W)	KBPC3501(W)	KBPC3502(W)	KBPC3504(W)	KBPC3506(W)	KBPC3508(W)		KBPC(W)
15.0	CP1500	CP1501	CP1502	CP1504	CP1506	CP1508		CP(W)
25.0	CP2500	CP2501	CP2502	CP2504	CP2506	CP2508		CP(W)
35.0	CP3500	CP3501	CP3502	CP3504	CP3506	CP3508		CP(W)
15.0	GL1500	GL1501	GL1502	GL1504	GL1506	GL1508		GL
25.0	GL2500	GL2501	GL2502	GL2504	GL2506	GL2508		GL
35.0	GL3500	GL3501	GL3502	GL3504	GL3506	GL3508		GL

SURFACE MOUNT DEVICE

PRV(V) TYPE NO Io(A)	50	100	200	400	600	800	1000	PACKAGE
0.5		B1S	B2S	B4S	B6S	B8S		SMDI
1.0	DI100S	DI101S	DI102S	DI104S	DI106S	DI108S	DI1010S	SDIP
1.5	DI150S	DI151S	DI152S	DI154S	DI156S	DI158S	DI1510S	SDIP

SWITCHING DIODE

Part No	Power Dissipation	MAX Average Rectified Current	Peak Voltage	Continuous Reverse Current	Forward voltage	Max Reversed Recovery Time	Package		
	Pa (mW)	Io (mA)	Vrrm (V)	IR@VR(V)	VF@IF(mA)	TRR (ns)	Bulk	Reel	Outline
1N914	500	200	100	25 @ 20	1.0 @ 10	4	1000	10000	DO-35
1N4148	500	200	100	25 @ 20	1.0 @ 10	4	1000	10000	DO-35
LL4148	500	150	100	25 @ 20	1.0 @ 10	4		2500	Mini-melf
MMBD148	350	200	100	5000 @ 75	1.0 @ 10	4		3000	SOT-23-1
MMBD4448	350	200	100	5000 @ 75	1.0 @ 10	4		3000	SOT-23-1
BAS16	350	200	100	1000 @ 75	1.0 @ 50	6		3000	SOT-23-1
BAS19	350	200	120	100 @ 120	1.0 @ 100	50		3000	SOT-23-1
BAS20	350	200	200	100 @ 150	1.0 @ 100	50		3000	SOT-23-1
BAS21	350	200	250	100 @ 200	1.0 @ 100	50		3000	SOT-23-1
BAW56	350	200	100	2500 @ 70	1.0 @ 50	4		3000	SOT-23-2
BAV70	350	200	100	5000 @ 70	1.0 @ 50	4		3000	SOT-23-3
BAV99	350	200	100	2500 @ 70	1.0 @ 50	4		3000	SOT-23-4
BAL99	350	200	100	2500 @ 70	1.0 @ 50	4		3000	SOT-23-5

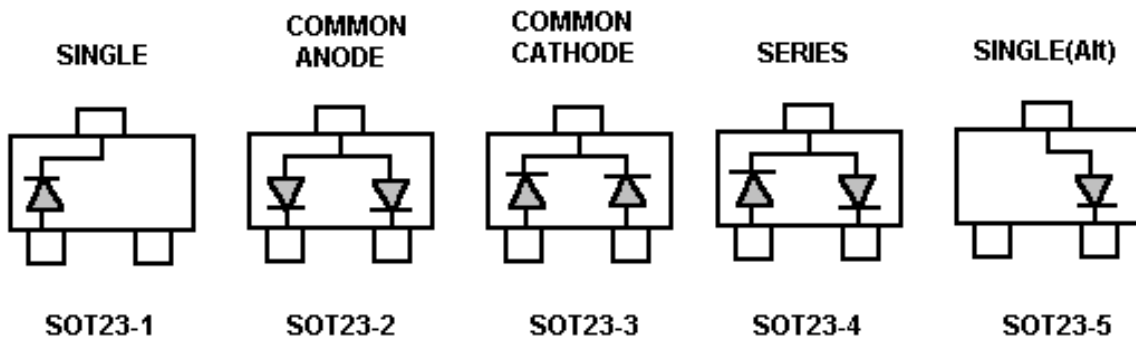

PACKAGE OUTLINE DIMENSIONS (all Dimensions in mm)

Axial Devices (Through-Hole)

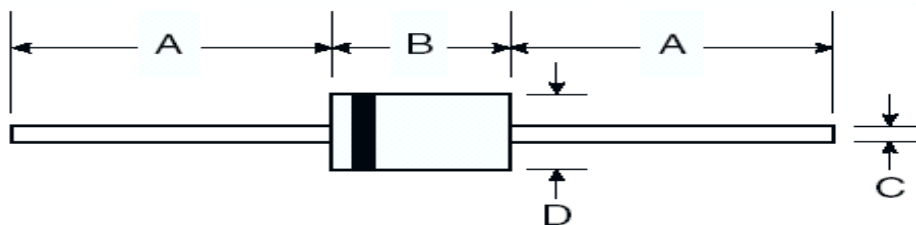

Dim	A		B		C		D	
	Min	Max	Min	Max	Min	Max	Min	Max
A-405	25.40	-	4.10	5.20	0.53	0.64	2.00	2.70
DO-35	25.40	-	-	4.00	-	0.60	-	2.00
DO-41 Plastic	25.40	-	4.06	5.21	0.71	0.86	2.00	2.72
DO-41 Glass	25.40	-	-	4.70	-	0.86	-	2.71
DO-15	25.40	-	5.50	7.62	0.69	0.89	2.60	3.60
DO-201	25.40	-	8.50	9.53	0.96	1.06	4.80	5.21
DO-201AD	25.40	-	7.20	9.50	1.20	1.30	4.80	5.30
P600	25.40	-	8.60	9.10	1.20	1.30	8.60	9.10

SMA, SMB, SMC

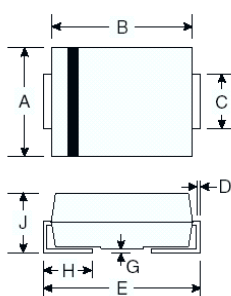

Dim	SMA		SMB		SMC	
	Min	Max	Min	Max	Min	Max
A	2.29	2.92	3.30	3.94	5.59	6.22
B	4.00	4.60	4.06	4.57	6.60	7.11
C	1.27	1.63	1.96	2.21	2.75	3.18
D	0.15	0.31	0.15	0.31	0.15	0.31
E	4.80	5.59	5.00	5.59	7.75	8.13
G	0.10	0.20	0.10	0.20	0.10	0.20
H	0.76	1.52	0.76	1.52	0.76	1.52
J	2.01	2.62	2.00	2.62	2.00	2.62

MiniMELF / MELF

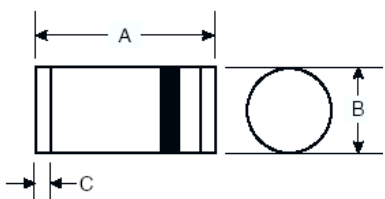

Dim	Mini MELF		MELF	
	Min	Max	Min	Max
A	3.3	3.7	4.8	5.2
B	1.3	1.6	2.4	2.6
C	0.28	0.5	0.55 Nominal	

SOD-123 / SOD-323/SOD-523

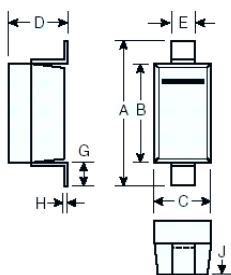

Dim	SOD-123		SOD-323		SOD-523	
	Min	Max	Min	Max	Min	Max
A	3.55	3.85	2.3	2.7	1.5	1.7
B	2.55	2.85	1.6	1.8	1.15	1.25
C	1.4	1.7	1.15	1.35	0.75	0.85
D	-	1.35	0.8	1.1	0.5	0.8
E	0.55 Typical		0.25	0.4	0.25	0.35
G	0.25	-	0.15	0.45	-	-
H	0.15 Typical		0.1	0.25	0.07	0.17

SOT-23 / SC-59 / SOT-323

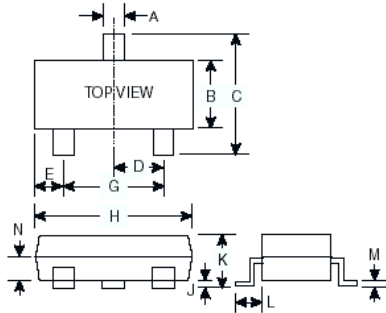

Dim	SOT-23		SC-59		SOT-323	
	Min	Max	Min	Max	Min	Max
A	0.37	0.51	0.3	0.5	0.3	0.4
B	1.19	1.4	1.4	1.8	1.15	1.35
C	2.1	2.5	2.5	3	2	2.2
D	0.89	1.05	0.85	1.05	0.65 Nominal	
E	0.45	0.61	0.3	0.7	0.3	0.4
G	1.78	2.05	1.7	2.1	1.2	1.4
H	2.65	3.05	2.7	3.1	1.8	2.2
J	0.013	0.15	-	0.1	0	0.1
K	0.89	1.1	1	1.4	0.9	1
L	0.45	0.61	0.55	0.7	0.25	0.4
M	0.076	0.178	0.1	0.35	0.1	0.25
N	-	-	-	-	-	-

SDIP

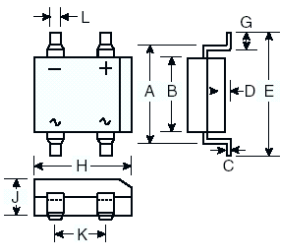

DIP

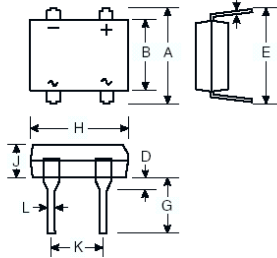

Dim	SDIP		SMDI		DIP	
	Min	Max	Min	Max	Min	Max
A	7.40	7.90	5.43	5.75	7.40	7.90
B	6.20	6.50	3.60	4.00	6.20	6.50
C	0.22	0.30	0.15	0.35	0.22	0.30
D	0.076	0.33	0.05	0.20	1.27	2.03
E	-	10.40	-	7.00	7.60	8.90
G	1.02	1.53	0.70	1.10	3.81	4.69
H	8.13	8.51	4.50	4.90	8.13	8.51
J	2.40	3.40	2.80	2.90	2.40	3.40
K	5.00	5.20	2.50	2.70	5.00	5.20
L	1.00	1.20	0.50	0.80	0.46	0.58

TO-220AC

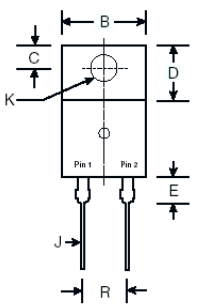

TO-220AB

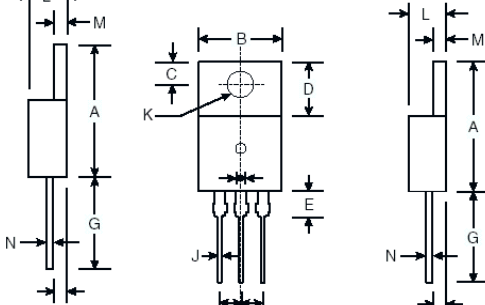

Dim	TO-220AC	TC-220AB
	Min	Max
A	14.22	15.88
B	9.65	10.67
C	2.54	3.43
D	5.84	6.86
E	-	6.35
G	12.70	14.73
H	2.29	2.79
J	0.51	1.14
K	3.53 \varnothing	4.09 \varnothing
L	3.56	4.83
M	1.14	1.40
N	0.30	0.64
P	2.03	2.92
R	4.83	5.33

D²PAK / TO263

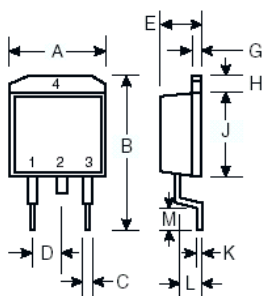

DPAK / TO252

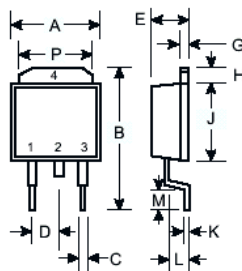

Dim	D2PAK/TO263		DPAK/TO252	
	Min	Max	Min	Max
A	9.65	10.69	6.3	6.7
B	14.6	15.88	-	10
C	0.51	1.14	0.3	0.8
D	2.29	2.79	2.3 Nominal	
E	4.37	4.83	2.1	2.5
G	1.14	1.4	0.4	0.6
H	1.14	1.4	1.2	1.6
J	8.25	9.25	5.3	5.7
K	0.3	0.64	0.5 Nominal	
L	2.03	2.92	1.3	1.8
M	2.29	2.79	1	-
P	-	-	5.1	5.5

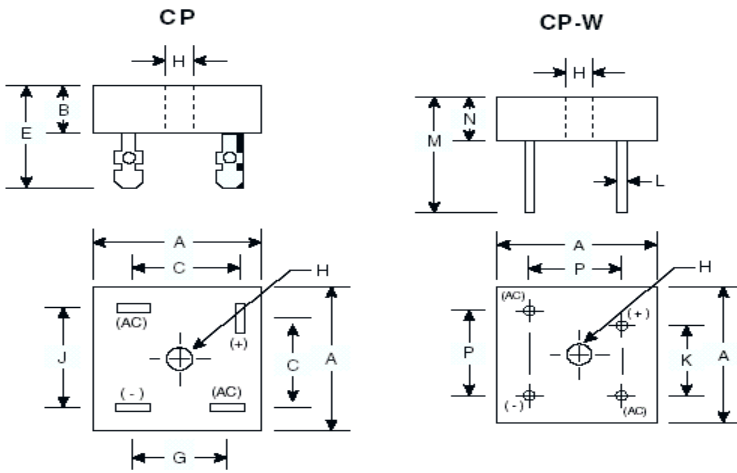

	CP(W)	
Dim	Min	Max
A	28.30	28.80
B	7.40	8.00
C	16.10	17.10
E	18.80	21.30
G	13.80	14.80
H	Hole for #10 screw	
	4.85Ø	5.59Ø
J	17.60	18.60
K	10.90	11.90
L	0.97Ø	1.07Ø
M	26.40	-
N	7.40	8.00
P	17.60	18.60

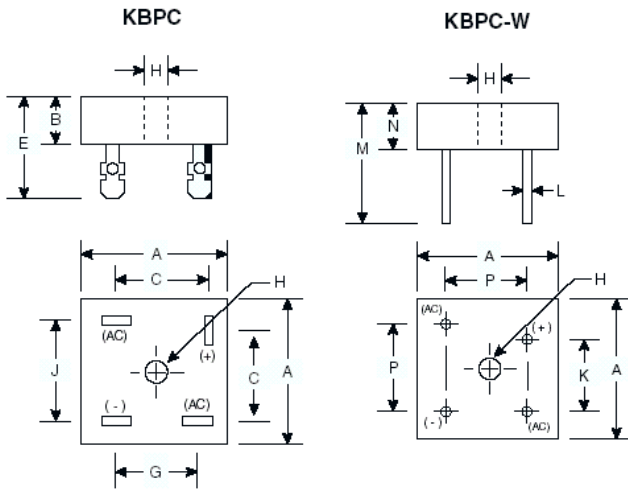

	KBPC(W)	
Dim	Min	Max
A	28.40	28.70
B	10.97	11.23
C	15.50	17.60
E	22.86	25.40
G	13.30	15.30
H	Hole for #10 screw	
	4.85Ø	5.59Ø
J	17.10	19.10
K	10.40	12.40
L	0.97Ø Nominal	1.07Ø
M	30.50	-
N	10.97	11.23
P	17.10	19.10

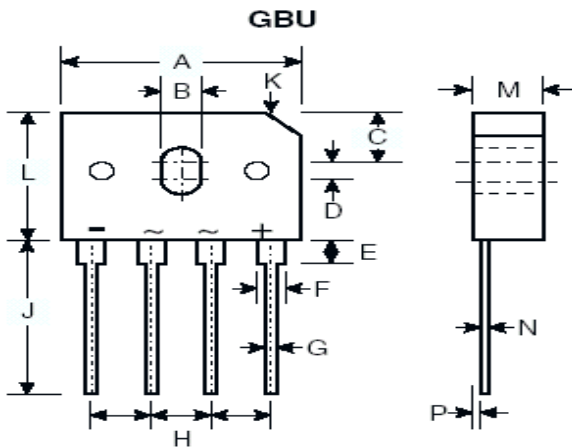

	GBU	
Dim	Min	Max
A	21.80	22.30
B	3.50	4.10
C	7.40	7.90
D	1.65	2.16
E	2.25	2.75
G	1.02	1.27
H	4.83	5.33
J	17.50	18.00
K	3.2 X 45°	
L	18.30	18.80
M	3.30	3.56
N	0.46	0.56
P	0.76	1.00

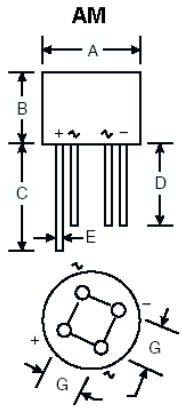

AM		
Dim	Min	Max
A	8.84	9.86
B	4.00	4.60
C	27.90	-
D	25.40	-
E	0.71	0.81
G	4.60	5.60

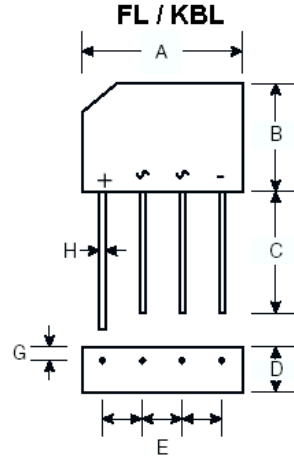

KBL		
Dim	Min	Max
A	18.50	19.50
B	15.40	16.40
C	19.00	-
D	6.20	6.50
E	4.60	5.60
G	1.50	2.00
H	1.3 Typical	

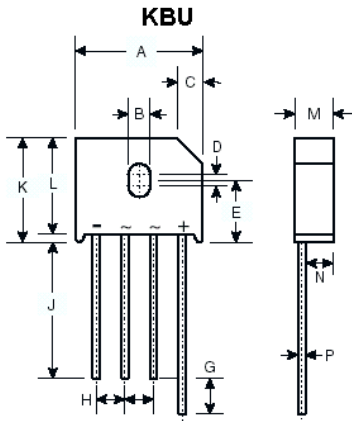

KBU		
Dim	Min	Max
A	22.70	23.70
B	3.80	4.10
C	4.20	4.70
D	1.70	2.20
E	10.30	11.30
G	4.50	6.80
H	4.80	5.80
J	25.40	-
K	-	19.30
L	16.80	17.80
M	6.60	7.10
N	4.70	5.20
P	1.20	1.30

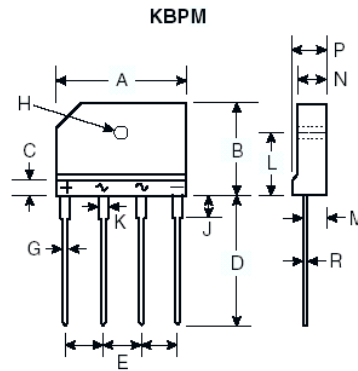

KBPM		
Dim	Min	Max
A	14.25	14.75
B	10.20	10.60
C	2.29	Typical
D	14.25	14.73
E	3.56	4.06
G	0.76	0.86
H	1.17	1.42
J	2.8 X 45° Chamfer	
K	0.80	1.10
L	3.35	3.65
M	3°Nominal	
N	2°Nominal	
P	0.30	0.64

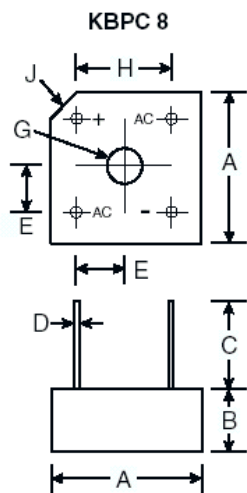

KBPC-8		
Dim	Min	Max
A	18.54	19.56
B	6.35	7.6
C	22.2	-
D	1.27ØTypical	
E	5.33	7.37
G	3.60Ø	4.00Ø
H	12.70 Typical	
J	2.38 X 45° Typical	

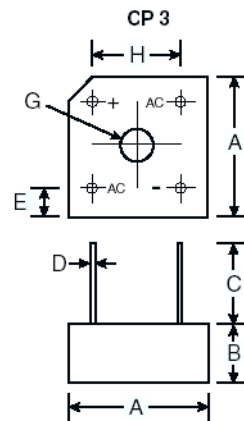

CP-3		
Dim	Min	Max
A	14.73	15.75
B	5.84	6.86
C	19.00	-
D	0.76ØTypical	
E	1.70	2.70
G	Hole for # 6 screw	
	3.60	4.00
H	10.30	11.30

				A					
284.00	315.00 - 385.00	P4KE350	P4KE350C	P6KE350	P6KE350C	1.5KE350	1,5KE350C		
300.00	332.00 - 368.00	P4KE350A	P4KE350CA	P6KE350	P6KE350CA	1.5KE350A	1,5KE350CA		
				A					
324.00	360.00 - 440.00	P4KE400	P4KE400C	P6KE400	P6KE400C	1.5KE400	1,5KE400C		
342.00	380.00 - 420.00	P4KE400A	P4KE400CA	P6KE400	P6KE400CA	1.5KE400A	1,5KE400CA		
				A					
356.00	396.00 - 484.00	P4KE440	P4KE440C	P6KE440	P6KE440C	1.5KE440	1,5KE440C		
376.00	418.00 - 462.00	P4KE440A	P4KE440CA	P6KE440	P6KE440CA	1.5KE440A	1,5KE440CA		
				A					

QUICK REFERENCE TABLE FOR AXIAL TRANSIENT DIODE

PP(W)		500		3000		5000		
PACKAGE		DO-15		P600		P600		
TYPE NO.	VRWM (V)	VBR(V) MIN-MAX	DIRECTIONAL		DIRECTIONAL		DIRECTIONAL	
			UNI	BI	UNI	BI	UNI	BI
5.00	6.40 - 7.55	SA5.0	SA5.0C	3KP5.0	3KP5.0C	5KP5.0	5KP5.0C	
5.00	6.40 - 7.55	SA5.0A	SA5.0CA	3KP5.0A	3KP5.0A	5KP5.0A	5KP5.0CA	
6.00	6.67 - 8.45	SA6.0	SA6.0C	3KP6.0	3KP6.0A	5KP6.0	5KP6.0C	
6.00	6.67 - 7.67	SA6.0A	SA6.0CA	3KP5.0A	3KP6.0CA	5KP6.0A	5KP6.0CA	
6.50	7.22 - 9.14	SA6.5	SA6.5C	3KP6.5	3KP6.5C	5KP6.5	5KP6.5C	
6.50	7.22 - 830	SA6.5A	SA6.5CA	3KP6.5A	3KP6.5CA	5KP6.5A	5KP6.5CA	
7.00	7.78 - 9.86	SA7.0	SA7.0C	3KP7.0	3KP7.0	5KP7.0	5KP7.0C	
7.00	7.78 - 8.98	SA7.0A	SA7.0CA	3KP7.0A	3KP7.0CA	5KP7.0A	5KP7.0CA	
7.50	8.33 - 10.67	SA7.5	SA7.5C	3KP7.5	3KP7.5C	5KP7.5	5KP7.5C	
7.50	8.33 - 9.58	SA7.5A	SA7.5CA	3KP7.5A	3KP7.5CA	5KP7.5A	5KP7.5CA	
8.00	8.89 - 11.30	SA8.0	SA8.0C	3KP8.0	3KP8.0C	5KP8.0	5KP8.0C	
8.00	8.89 - 10.23	SA8.0A	SA8.0CA	3KP8.0A	3KP8.0CA	5KP8.0A	5KP8.0CA	
8.50	9.44 - 11.92	SA8.5	SA8.5C	3KP8.5	3KP8.5C	5KP8.5	5KP8.5C	
8.50	9.44 - 10.82	SA8.5A	SA8.5CA	3KP8.5A	3KP8.5CA	5KP8.5A	5KP8.5CA	
9.00	10.00 - 12.60	SA9.0	SA9.0C	3KP9.0	3KP9.0C	5KP9.0	5KP9.0C	
9.00	10.00 - 11.50	SA9.0A	SA9.0CA	3KP9.0A	3KP9.0CA	5KP9.0A	5KP9.0CA	
10.00	11.10 - 14.10	SA10	SA10C	3KP10	3KP10C	5KP10	5KP10C	
10.00	11.10 - 12.80	SA10A	SA10CA	3KP10A	3KP10CA	5KP10A	5KP10CA	
11.00	12.20 - 15.40	SA11	SA11C	3KP11	3KP11C	5KP11	5KP11C	
11.00	12.20 - 14.00	SA11A	SA11CA	3KP11A	3KP11CA	5KP11A	5KP11CA	
12.00	13.30 - 16.90	SA12	SA12C	3KP12	3KP12C	5KP12	5KP12C	
12.00	13.30 - 15.30	SA12A	SA12CA	3KP12A	3KP12CA	5KP12A	5KP12CA	
13.00	14.40 - 18.20	SA13	SA13C	3KP13	3KP13C	5KP13	5KP13C	
13.00	14.40 - 16.50	SA13A	SA13CA	3KP13A	3KP13CA	5KP13A	5KP13CA	
14.00	15.60 - 19.80	SA14	SA14C	3KP14	3KP14C	5KP14	5KP14C	
14.00	15.60 - 17.90	SA14A	SA14CA	3KP14A	3KP14CA	5KP14A	5KP14CA	
15.00	16.70 - 21.10	SA15	SA15C	3KP15	3KP15C	5KP15	5KP15C	
15.00	16.70 - 19.20	SA15A	SA15CA	3KP15A	3KP15CA	5KP15A	5KP15CA	
16.00	17.80 - 22.60	SA16	SA16C	3KP16	3KP16C	5KP16	5KP16C	
16.00	17.80 - 20.50	SA16A	SA16CA	3KP16A	3KP16CA	5KP16A	5KP16CA	
17.00	18.90 - 23.90	SA17	SA17C	3KP17	3KP17C	5KP17	5KP17C	
17.00	18.90 - 21.70	SA17A	SA17CA	3KP17A	3KP17CA	5KP17A	5KP17CA	
18.00	20.00 - 25.30	SA18	SA18C	3KP18	3KP18C	5KP18	5KP18C	
18.00	20.00 - 23.30	SA18A	SA18CA	3KP18A	3KP18CA	5KP18A	5KP18CA	
20.00	22.20 - 28.10	SA20	SA20C	3KP20	3KP20C	5KP20	5KP20C	
20.00	22.20 - 25.50	SA20A	SA20CA	3KP20A	3KP20CA	5KP20A	5KP20CA	
22.00	24.40 - 30.90	SA22	SA22C	3KP22	3KP22C	5KP22	5KP22C	
22.00	24.40 - 28.00	SA22A	SA22CA	3KP22A	3KP22CA	5KP22A	5KP22CA	
24.00	26.70 - 33.80	SA24	SA24C	3KP24	3KP24C	5KP24	5KP24C	
24.00	26.70 - 30.70	SA24A	SA24CA	3KP24A	3KP24CA	5KP24A	5KP24CA	
26.00	28.90 - 36.60	SA26	SA26C	3KP26	3KP26C	5KP26	5KP26C	
26.00	28.90 - 33.20	SA26A	SA26CA	3KP26A	3KP26CA	5KP26A	5KP26CA	
28.00	31.10 - 39.40	SA28	SA28C	3KP28	3KP28C	5KP28	5KP28C	
28.00	31.10 - 35.80	SA28A	SA28CA	3KP28A	3KP28CA	5KP28A	5KP28CA	
30.00	33.30 - 42.20	SA30	SA30C	3KP30	3KP30C	5KP30	5KP30C	
30.00	33.30 - 38.30	SA30A	SA30CA	3KP30A	3KP30CA	5KP30A	5KP30CA	
33.00	36.70 - 46.50	SA33	SA33C	3KP33	3KP33C	5KP33	5KP33C	
33.00	36.70 - 42.20	SA33A	SA33CA	3KP33A	3KP33CA	5KP33A	5KP33CA	
36.00	40.00 - 50.70	SA36	SA36C	3KP36	3KP36C	5KP36	5KP36C	
36.00	40.00 - 46.00	SA36A	SA36CA	3KP36A	3KP36CA	5KP36A	5KP36CA	
40.00	44.40 - 56.30	SA40	SA40C	3KP40	3KP40C	5KP40	5KP40C	
40.00	44.40 - 51.10	SA40A	SA40CA	3KP40A	3KP40CA	5KP40A	5KP40CA	
43.00	47.80 - 60.50	SA43	SA43C	3KP43	3KP43C	5KP43	5KP43C	
43.00	47.80 - 54.90	SA43A	SA43CA	3KP43A	3KP43CA	5KP43A	5KP43CA	
45.00	50.00 - 63.30	SA45	SA45C	3KP45	3KP45C	5KP45	5KP45C	
45.00	50.00 - 57.50	SA45A	SA45CA	3KP45A	3KP45CA	5KP45A	5KP45CA	
48.00	53.30 - 67.50	SA48	SA48C	3KP48	3KP48C	5KP48	5KP48C	
48.00	53.30 - 61.30	SA48A	SA48CA	3KP48A	3KP48CA	5KP48A	5KP48CA	
51.00	56.70 - 71.80	SA51	SA51C	3KP51	3KP51C	5KP51	5KP51C	
51.00	56.70 - 65.20	SA51A	SA51CA	3KP51A	3KP51CA	5KP51A	5KP51CA	
54.00	60.00 - 76.00	SA54	SA54C	3KP54	3KP54C	5KP54	5KP54C	
54.00	60.00 - 69.00	SA54A	SA54CA	3KP54A	3KP54CA	5KP54A	5KP54CA	
58.00	64.40 - 81.60	SA58	SA58C	3KP58	3KP58C	5KP58	5KP58C	
58.00	64.40 - 74.10	SA58A	SA58CA	3KP58A	3KP58CA	5KP58A	5KP58CA	
60.00	66.70 - 84.50	SA60	SA60C	3KP60	3KP60C	5KP60	5KP60C	
60.00	66.70 - 76.70	SA60A	SA60CA	3KP60A	3KP60CA	5KP60A	5KP60CA	
64.00	71.10 - 90.10	SA64	SA64C	3KP64	3KP64C	5KP64	5KP64C	
64.00	71.10 - 81.80	SA64A	SA64CA	3KP64A	3KP64CA	5KP64A	5KP64CA	
70.00	77.80 - 98.60	SA70	SA70C	3KP70	3KP70C	5KP70	5KP70C	
70.00	77.80 - 89.50	SA70A	SA70CA	3KP70A	3KP70CA	5KP70A	5KP70CA	
75.00	83.30 - 105.70	SA75	SA75C	3KP75	3KP75C	5KP75	5KP75C	
75.00	83.30 - 99.70	SA75A	SA75CA	3KP75A	3KP75CA	5KP75A	5KP75CA	
78.00	86.70 - 109.80	SA78	SA78C	3KP78	3KP78C	5KP78	5KP78C	
78.00	86.70 - 99.70	SA78A	SA78CA	3KP78A	3KP78CA	5KP78A	5KP78CA	
85.00	94.40 - 119.20	SA85	SA85C	3KP85	3KP85C	5KP85	5KP85C	
85.00	94.40 - 108.20	SA85A	SA85CA	3KP85A	3KP85CA	5KP85A	5KP85CA	
90.00	100.00 - 126.50	SA90	SA90C	3KP90	3KP90C	5KP90	5KP90C	
90.00	100.00 - 115.50	SA90A	SA90CA	3KP90A	3KP90CA	5KP90A	5KP90CA	
100.00	111.00 - 141.00	SA100	SA100C	3KP100	3KP100C	5KP100	5KP100C	
100.00	111.00 - 128.00	SA100A	SA100CA	3KP100A	3KP100CA	5KP100A	5KP100CA	
110.00	122.00 - 154.50	SA110	SA110C	3KP110	3KP110C	5KP110	5KP110C	
110.00	122.00 - 140.50	SA110A	SA110CA	3KP110A	3KP110CA	5KP110A	5KP110CA	
120.00	133.00 - 169.00	SA120	SA120C	3KP120	3KP120C	5KP120	5KP120C	
120.00	133.00 - 169.00	SA120A	SA120CA	3KP120A	3KP120CA	5KP120A	5KP120CA	
130.00	144.00 - 182.50	SA130	SA130C	3KP130	3KP130C	5KP130	5KP130C	
130.00	144.00 - 165.50	SA130A	SA130CA	3KP130A	3KP130CA	5KP130A	5KP130CA	
150.00	167.00 - 211.50	SA150	SA150C	3KP150	3KP150C	5KP150	5KP150C	
150.00	167.00 - 192.50	SA150A	SA150CA	3KP150A	3KP150CA	5KP150A	5KP150CA	
160.00	178.00 - 226.00	SA160	SA160C	3KP160	3KP160C	5KP160	5KP160C	
160.00	178.00 - 205.00	SA160A	SA160CA	3KP160A	3KP160CA	5KP160A	5KP160CA	
170.00	189.00 - 239.50	SA170	SA170C	3KP170	3KP170C	5KP170	5KP170C	

