

Protection devices

Selection guide



April 2006

Contents

Introduction	4
Product references	5
ESD production	6
Standards and technical recommendations	6
EOS and ESD transient voltage suppressor: Transil™	8
Data protection against ESD	13
Telecom protection	17
Standards	17
Surge protection: Trisil™	17
Protection ICs	19
Protection devices cross-reference	24
Application notes	45
Package range	46

Introduction

The aim of this selection guide is to provide users of protection devices with the latest information about the ST portfolio relevant to EMC and telecom standards.

To allow a quick selection for the user, we have separated the categories of devices into two sections:

- ESD (electro-static discharge) protection
- Telecom protection

Our aim is to assure the highest immunity of systems with highly integrated products

Product references

Transil: transient voltage suppressors

Transil families have been arranged by power and packaging

BZWxx-yyyb		
xx	Power	04 = 400W 06 = 600W 50 = 5000W
yy or yyy	Stand off voltage	10 = 10V 5V8 = 5.8V
B	Bidirectional	Otherwise: unidirectional
Package	BZW04 BZW06 BZW50	DO-15 DO-15 R6

xxKEyyyCA		
xx	Power	P6 = 600W 1.5 = 1500W
yy or yyy	Breakdown voltage	100 = 100V 6V8 = 6.8V
C	Bidirectional	Otherwise: unidirectional
Package	P6KE 1.5KE	DO-15 DO-201

SMxTyyyCA		
SM	Surface Mount Package	
xx	Power	02 = 200W 06 = 600W 15 = 1500W
yy or yyy	Breakdown voltage	100 = 10V 6V8 = 6.8V
C	Bidirectional	Otherwise: unidirectional
Package	SM2T SM6T SM15T	STmite SMB SMC

SMxJyyyCA		
SM	Surface Mount Package	
x	Power	A = 400W B = 600W C = 1500W
yy or yyy	Stand off voltage	48 = 48V 6.0 = 6V
C	Bidirectional	Otherwise: unidirectional
Package	SMAJ SMBJ SMCJ	SMA SMB SMC

Transil: data protection

Data protection products have been arranged by power and packaging

ESDAxx-yz/ESDALCxx-yz	
ESDA	ElectroStatic Discharge Array
ESDALC	ElectroStatic Discharge Array Low Capacitance
xx	Breakdown voltage
y	Number of diodes (optional)
z	Package (see on page 46)

DAxyy/DALCxyyz	
DA	Diode Array
DALC	Diode Array Low Capacitance
x	Version code
yy	Number of diodes
z	Package (see on page 46)

USBxyy/USBLCx-yz	
USB	USB array function
USBLC	USB Low Capacitance array function
xx	Breakdown voltage
y	Number of line protected
z	Package (see on page 46)

DVIULCx-yz/HDMIULCx-yz	
DVIULC	DVI diode array Ultra Low Capacitance function
HDMIULC	HDMI diode array Ultra Low Capacitance function
x	Breakdown voltage
y	Number of lines protected
z	Package (see on page 46)

Transil: surge suppressors

Trisil families have been arranged by peak pulse current and packaging

TPAyyy/SMTPAyyy	
SMTP	Surface Mount Telecom Protection
or TP	Telecom Protection (axial)
A	Peak pulse current = 50A (10/1000µs)
yyy	Breakdown voltage
Package	TPA = DO-15 SMTPA = SMB

SMPxx-yyy/SMPxxxLC-yyy/SMPxxxMC-yyy		
SMP	Surface Mount Protection	
xx or xxx	Peak pulse current (10/1000µs)	30 = 30A 50 = 50A 80 = 50A 100 = 100A
LC	Low Capacitance	
MC	Micro Capacitance	
Blank	Standard capacitance	
Package	SMP30 SMP50 SMP80 SMP100	SMA SMA SMB SMB

Transil ICs: surge suppressors ICs

Trisil families have been arranged by peak pulse current and packaging

LCP152		
LCP	Line Card Protection	
15	IH = 150mA	
2	Version 2	
xxx	Package	DEE = QFN 3x3 1S = SO-8

LCP02-150x		
LCP02	Line Card Protection for dual voltage SLICs	
150	IH = 150mA	
x	Package	30 = 30A M = PowerSO-10 B1 = SO-8 Wide

Standards and technical recommendations

ST protection devices address a number of applications, which are governed by many different standards. All equipment that is potentially subject to hot plugging, or human contact, should be submitted to ESD tests. The two worldwide standards for ESD are described below. They are covered by ST's ESDA and DA families.

All circuits that are susceptible to electrical overstresses, such as a power supply spikes, should comply with the worldwide EOS (electrical overstress) standard IEC 61000-4-5 presented below. This standard is covered by ST's Transil range.

IEC 6100-4-2: electrostatic discharge

The goal of this standard is to simulate the ESD surges, applied to the equipment from a charged metallic object, by contact or through the air. Four levels of compliance are defined, with associated voltage and current values.

Contact discharge model

Class	Contact discharge		Air discharge
	Test voltage kV	Max current A	Test voltage kV
1	2	7.5	2
2	4	15	4
3	6	22.5	8
4	8	30	15

ESD surge generator

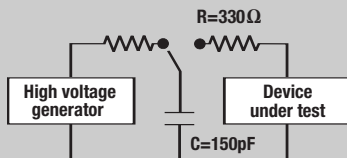

ESD discharge waveform

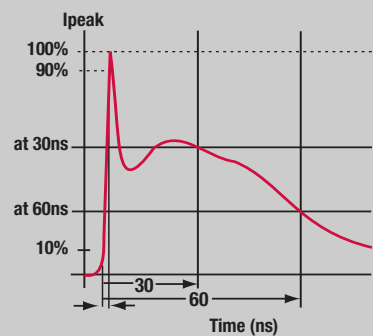

IEC 61000-4-5: electrical overstress surge

The goal of this standard is to simulate EOS generated by the electrical environment of the equipment. Four levels of compliance are defined, with associated voltages. The maximum current depends on the circuit impedance of 10 or 40 Ω, in addition to the 2 Ω generator impedance.

EOS model

Class	Test voltage kV
1	0.5
2	1
3	2
4	4

EOS surge generator

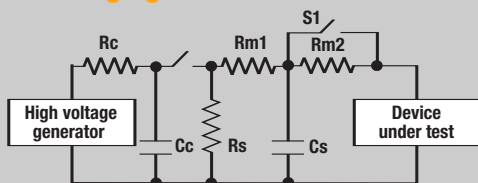

EOS waveform

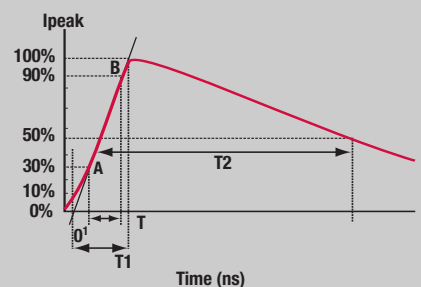

ESD protection

Human body model MIL-883E method 3015.7: electrostatic discharge

This standard goal is to simulate the ESD surges generated by human contact. It applies to the electrical components, and includes three levels of compliance, with associated voltage and current values.

Contact discharge model

Class	Test voltage kV	Max current A
1	0-1.999	1.33
2	2-3.999	2.67
3	>4	>2.67

ESD surge generator

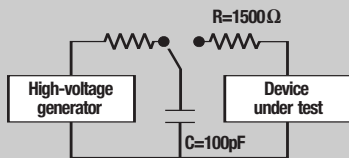

ESD discharge waveform

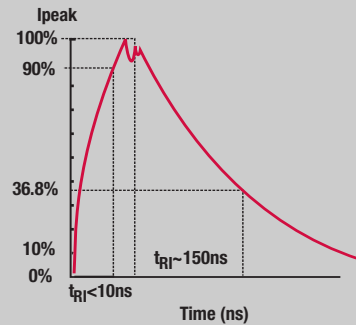

Clamping or rail-to-rail principles

In terms of ESD protection, two product families are available: clamping or rail-to-rail devices. Once the right device has been defined, the circuit layout must then be optimized, taking into consideration the parasitic effects of wires, package leads and copper tracks. These phenomena are detailed below.

Transil approach

The ESDAx clamping solution uses the monolithic integration of transil diodes. This family offers highly integrated solutions in micropackages for 2, through 18 lines.

Rail-to-rail approach

The rail to rail solution uses two fast diodes connected to voltage references per dataline to be protected. This solution is especially recommended for high speed lines, due to its very low capacitance (no signal distortion)

Benefits

- No power supply disturbance

Drawbacks

- Fixed voltage
- Higher capacitance than rail-to-rail

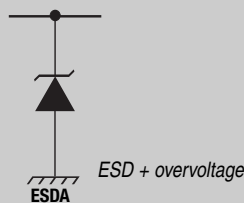

Benefits

- Very low capacitance
- Programmable

Drawbacks

- Power supply disturbance

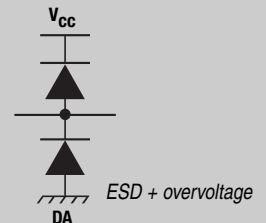

Kelvin method connection

The separated input and output avoid the overvoltage due to the parasitic inductance of the wires and leads: ($L \times dl/dt$)

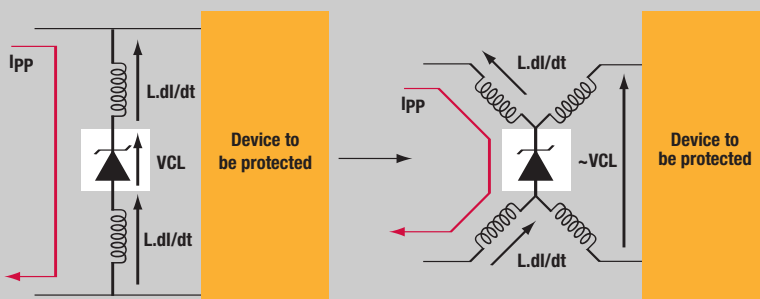

EOS and ESD transient voltage suppressor: Transil

The clamping solution:

Used as a means of parallel protection, the Transil is designed to protect components sensitive to parasitic overvoltages from EOS (electrical overstress) and ESD (electro-static discharge). The power rating of the protection must be chosen according to the application constraints.

The stand-off voltage value (V_{RM}) should be equal to or higher than the maximum operating voltage in the application. The clamping voltage V_{CL} (at peak current value) should be compatible with the sensitive component. The transil solution offers a very fast response time and reproducible operation thanks to its silicon structure.

I/V Transil characteristics

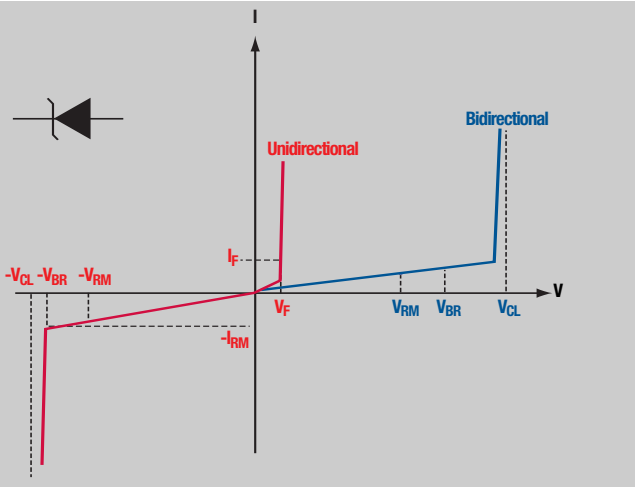

Protection with Transil

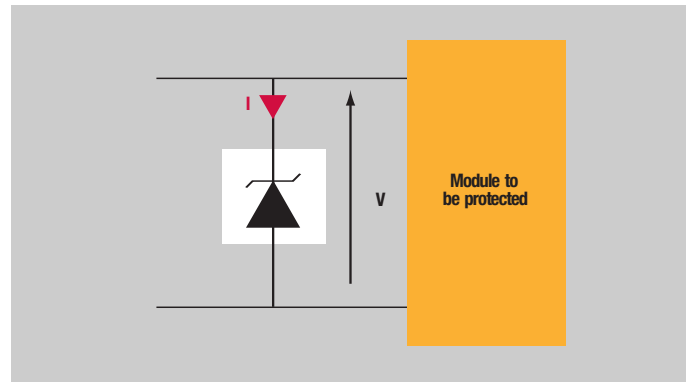

Low noise block protection

The LNBTVSx-22xx provides dedicated lightning and electrical overstress surge protection for LNB (Low Noise Block module) voltage regulators in satellite Set-Top Box applications. This device provides the lightning protection required to pass IEC and FCC regulations.

LNB voltage regulator protection

Power* (W)	V_{RM} (V)	I_{RM} max @ V_{RM} (μ A)	Part number	V_{BR} min @ I_R			V_{CL} max @ I_{PP} onde 8/20 μ s		I_{FSM} (A)	Package	
				Unidirect.	Min (V)	Typ	Max (mA)	(V)			(A)
SMD and Axial											
1500	20	1	LNBTVS3-220	22	23.1	24.2	1	35	250	200	DO-201
1500	20	1	LNBTVS3-220U	22	23.1	24.2	1	35	250	200	SMB
1800	20	1	LNBTVS4-220	22	23.1	24.2	1	35	331	200	DO-201
1800	20	1	LNBTVS4-220S	22	23.1	24.2	1	35	331	200	SMC
2000	20	1	LNBTVS4-221	22	23.1	24.2	1	32	331	200	DO-201
2000	20	1	LNBTVS4-221S	22	23.1	24.2	1	32	331	200	SMC
3000	20	1	LNBTVS4-222S	22	23.1	24.2	1	30	331	200	SMC
2000	20	1	LNBTVS6-220S	22	23.1	24.2	1	35	500	200	SMC
3000	20	1	LNBTVS6-221S	22	23.1	24.2	1	32	500	200	SMC

* 10/1000 μ s waveform

ESD protection

LNB application diagram

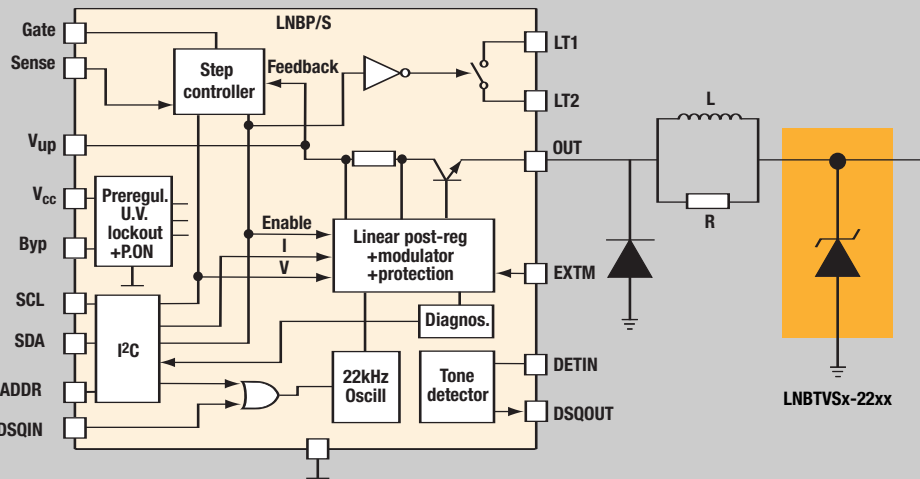

EOS and ESD transient voltage suppressor: Transil

Power* (W)	V _{RM} (V)	I _{RM} max @ V _{RM} (μA)	Part number		V _{BR} min @ I _R		V _{CL} max @ I _{PP}		I _{FSM} (A)	Package
			Unidirect.		(V)	(mA)	(V)	(A)		
200W Transils – STmite										
200	3.3	500	SM2T3V3A		3.6	1	6.5	25	25	STmite
200	5	50	SM2T6V8A		6.4	10	9.2	19.6	25	STmite
200	12	1	SM2T14A		13.3	1	19.9	9.0	25	STmite
200	16	1	SM2T18A		17.1	1	26	7	25	STmite
200	24	1	SM2T27A		25.7	1	38.9	4.6	25	STmite

Power* (W)	V _{RM} (V)	I _{RM} max @ V _{RM} (μA)	Part number		V _{BR} min @ I _R		V _{CL} max @ I _{PP}		I _{FSM} (A)	Package
			Unidirect.	Bidirect.	(V)	(mA)	(V)	(A)		
400W Transils – Axial										
400	5.8	1000	BZW04-5V8	BZW04-5V8B	6.45	10	10.5	38	30	DO-15
400	10.2	5	BZW04-10	BZW04-10B	11.4	1	16.7	24	30	DO-15
400	12.8	5	BZW04-13	BZW04-13B	14.3	1	21.2	19	30	DO-15
400	15.3	1	BZW04-15	BZW04-15B	17.1	1	25.2	16	30	DO-15
400	25.6	1	BZW04-26	BZW04-26B	28.5	1	41.5	9.6	30	DO-15
400	28.2	1	BZW04-28	BZW04-28B	31.4	1	45.7	8.6	30	DO-15
400	30.8	1	BZW04-31	BZW04-31B	34.2	1	49.9	8	30	DO-15
400	33.3	1	BZW04-33	BZW04-33B	37.1	1	53.9	7.4	30	DO-15
400	47.8	1	BZW04-48	BZW04-48B	53.2	1	77	5.2	30	DO-15
400	239	1	BZW04-239	BZW04-239B	266	1	384	1.5	30	DO-15
400	299	1	BZW04-299	BZW04-299B	332	1	482	0.9	30	DO-15
400	342	1	BZW04-342	BZW04-342B	380	1	548	0.9	30	DO-15
400	376	1	BZW04-376	BZW04-376B	418	1	603	0.8	30	DO-15

* 10/1000μs

EOS and ESD transient voltage suppressor: Transil

Power* (W)	V _{RM} (V)	I _{RM} max @ V _{RM} (µA)	Part number		V _{BR} min @ I _R		V _{CL} max @ I _{PP}		I _{FSM} (A)	Package
			Unidirect.	Bidirect.	(V)	(mA)	(V)	(A)		
400W Transils – SMA										
400	5	800	SMAJ5.0A-TR	SMAJ5.0CA-TR	6.4	10	9.2	43.5	40	SMA
400	6	800	SMAJ6.0A-TR	SMAJ6.0CA-TR	6.7	10	10.3	38.8	40	SMA
400	6.5	500	SMAJ6.5A-TR	SMAJ6.5CA-TR	7.2	10	11.2	35.7	40	SMA
400	10	5	SMAJ10A-TR	SMAJ10CA-TR	11.1	1	17	23.5	40	SMA
400	12	5	SMAJ12A-TR	SMAJ12CA-TR	13.3	1	19.9	20.1	40	SMA
400	13	1	SMAJ13A-TR	SMAJ13CA-TR	14.4	1	21.5	18.6	40	SMA
400	15	1	SMAJ15A-TR	SMAJ15CA-TR	16.7	1	24.4	16.4	40	SMA
400	18	1	SMAJ18A-TR	SMAJ18CA-TR	20	1	29.2	13.7	40	SMA
400	22	1	SMAJ22A-TR	SMAJ22CA-TR	24.4	1	35.5	11.2	40	SMA
400	24	1	SMAJ24A-TR	SMAJ24CA-TR	26.7	1	38.9	10.3	40	SMA
400	26	1	SMAJ26A-TR	SMAJ26CA-TR	28.9	1	42.1	9.5	40	SMA
400	28	1	SMAJ28A-TR	SMAJ28CA-TR	31.1	1	45.4	8.8	40	SMA
400	30	1	SMAJ30A-TR	SMAJ30CA-TR	33.3	1	48.4	8.3	40	SMA
400	33	1	SMAJ33A-TR	SMAJ33CA-TR	36.7	1	53.3	7.5	40	SMA
400	40	1	SMAJ40A-TR	SMAJ40CA-TR	44.4	1	64.5	6.2	40	SMA
400	43	1	SMAJ43A-TR	SMAJ43CA-TR	47.8	1	69.7	5.7	40	SMA
400	48	1	SMAJ48A-TR	SMAJ48CA-TR	53.3	1	77.4	5.2	40	SMA
400	58	1	SMAJ58A-TR	SMAJ58CA-TR	64.4	1	93.6	4.3	40	SMA
400	70	1	SMAJ70A-TR	SMAJ70CA-TR	77.8	1	113	3.5	40	SMA
400	85	1	SMAJ85A-TR	SMAJ85CA-TR	94.4	1	137	2.9	40	SMA
400	130	1	SMAJ130A-TR	SMAJ130CA-TR	144	1	209	1.9	40	SMA
400	170	1	SMAJ170A-TR	SMAJ170CA-TR	189	1	275	1.4	40	SMA
400	188	1	SMAJ188A-TR	SMAJ188CA-TR	209	1	328	1.4	40	SMA
600W Transils – Axial										
600	5.8	1000	BZW06-5V8	BZW06-5V8B	6.45	10	10.5	57	100	DO-15
600	6.4	500	BZW06-6V4	BZW06-6V4B	7.13	10	11.3	53	100	DO-15
600	10.2	5	BZW06-10	BZW06-10B	11.4	1	16.7	36	100	DO-15
600	12.8	5	BZW06-13	BZW06-13B	14.3	1	21.2	28	100	DO-15
600	13.6	5	BZW06-14	BZW06-14B	15.2	1	22.5	27	100	DO-15
600	15.3	1	BZW06-15	BZW06-15B	17.1	1	25.2	24	100	DO-15
600	18.8	1	BZW06-19	BZW06-19B	20.9	1	30.6	20	100	DO-15
600	23.1	1	BZW06-23	BZW06-23B	25.7	1	37.5	16	100	DO-15
600	25.6	1	BZW06-26	BZW06-26B	28.5	1	41.5	14.5	100	DO-15
600	28.2	1	BZW06-28	BZW06-28B	31.4	1	45.7	13.1	100	DO-15
600	30.8	1	BZW06-31	BZW06-31B	34.2	1	49.9	12	100	DO-15
600	33.3	1	BZW06-33	BZW06-33B	37.1	1	53.9	11.1	100	DO-15
600	47.8	1	BZW06-48	BZW06-48B	53.2	1	77	7.8	100	DO-15
600	273	1	BZW06-273	BZW06-273B	304	1	438	1.6	100	DO-15
600	342	1	BZW06-342	BZW06-342B	380	1	548	1.3	100	DO-15
600	376	1	BZW06-376	BZW06-376B	418	1	603	1.3	100	DO-15
600	5.8	1000	P6KE6V8A	P6KE6V8CA	6.45	10	10.5	57	100	DO-15
600	6.4	500	P6KE7V5A	P6KE7V5CA	7.13	10	11.3	53	100	DO-15
600	12.8	1	P6KE15A	P6KE15CA	14.3	1	21.2	28	100	DO-15
600	15.3	1	P6KE18A	P6KE18CA	17.1	1	25.2	24	100	DO-15
600	23.1	1	P6KE27A	P6KE27CA	25.7	1	37.5	16	100	DO-15
600	25.6	1	P6KE30A	P6KE30CA	28.5	1	41.5	14.5	100	DO-15
600	28.2	1	P6KE33A	P6KE33CA	31.4	1	45.7	13.1	100	DO-15
600	30.8	1	P6KE36A	P6KE36CA	34.2	1	49.9	12	100	DO-15
600	33.3	1	P6KE39A	P6KE39CA	37.1	1	53.9	11.1	100	DO-15
600	47.8	1	P6KE56A	P6KE56CA	53.2	1	77	7.8	100	DO-15
600	58.1	1	P6KE68A	P6KE68CA	64.6	1	92	6.5	100	DO-15
600	70.1	1	P6KE82A	P6KE82CA	77.9	1	113	5.3	100	DO-15
600	171	1	P6KE200A	P6KE200CA	190	1	274	2.2	100	DO-15
600	213	1	P6KE250A	P6KE250CA	237	1	344	2	100	DO-15
600	256	1	P6KE300A	P6KE300CA	285	1	414	1.6	100	DO-15
600	342	1	P6KE400A	P6KE400CA	380	1	548	1.3	100	DO-15
600	376	1	P6KE440A	P6KE440CA	418	1	603	1.3	100	DO-15

* 10/1000µs waveform

ESD protection

EOS and ESD transient voltage suppressor: Transil

Power* (W)	V _{RM} (V)	I _{RM} max @ V _{RM} (µA)	Part number		V _{BR} min @ I _R		V _{CL} max @ I _{PP}		I _{FSM} (A)	Package
			Unidirect.	Bidirect.	(V)	(mA)	(V)	(A)		
600W Transils – SMB										
600	5.8	1000	SM6T6V8A	SM6T6V8CA	6.45	10	10.5	57	100	SMB
600	6.4	500	SM6T7V5A	SM6T7V5CA	7.13	10	11.3	53	100	SMB
600	8.55	10	SM6T10A	SM6T10CA	9.5	1	14.5	41	100	SMB
600	10.2	5	SM6T12A	SM6T12CA	11.4	1	16.7	36	100	SMB
600	12.8	5	SM6T15A	SM6T15CA	14.3	1	21.2	28	100	SMB
600	15.3	5	SM6T18A	SM6T18CA	17.1	1	25.2	24	100	SMB
600	18.8	5	SM6T22A	SM6T22CA	20.9	1	30.6	20	100	SMB
600	20.5	5	SM6T24A	SM6T24CA	22.8	1	33.2	18	100	SMB
600	23.1	5	SM6T27A	SM6T27CA	25.7	1	37.5	16	100	SMB
600	25.6	5	SM6T30A	SM6T30CA	28.5	1	41.5	14.5	100	SMB
600	28.2	5	SM6T33A	SM6T33CA	31.4	1	45.7	13.1	100	SMB
600	30.8	5	SM6T36A	SM6T36CA	34.2	1	49.9	12	100	SMB
600	33.3	5	SM6T39A	SM6T39CA	37.1	1	53.9	11.1	100	SMB
600	58.1	5	SM6T68A	SM6T68CA	64.6	1	92	6.5	100	SMB
600	85.5	5	SM6T100A	SM6T100CA	95	1	137	4.4	100	SMB
600	128	5	SM6T150A	SM6T150CA	143	1	207	2.9	100	SMB
600	171	5	SM6T200A	SM6T200CA	190	1	274	2.2	100	SMB
600	188	5	SM6T220A	SM6T220CA	209	1	328	2	100	SMB
600	5	800	SMBJ5.0A-TR	SMBJ5.0CA-TR	6.4	10	9.2	68	100	SMB
600	6	800	SMBJ6.0A-TR	SMBJ6.0CA-TR	6.7	10	10.3	61	100	SMB
600	6.5	500	SMBJ6.5A-TR	SMBJ6.5CA-TR	7.2	10	11.2	56	100	SMB
600	10	5	SMBJ10A-TR	SMBJ10CA-TR	11.1	1	17	37	100	SMB
600	12	5	SMBJ12A-TR	SMBJ12CA-TR	13.3	1	19.9	31	100	SMB
600	13	1	SMBJ13A-TR	SMBJ13CA-TR	14.4	1	21.5	29	100	SMB
600	15	1	SMBJ15A-TR	SMBJ15CA-TR	16.7	1	24.4	25.1	100	SMB
600	18	1	SMBJ18A-TR	SMBJ18CA-TR	20	1	29.2	21.5	100	SMB
600	22	1	SMBJ22A-TR	SMBJ22CA-TR	24.4	1	35.5	17.7	100	SMB
600	24	1	SMBJ24A-TR	SMBJ24CA-TR	26.7	1	38.9	16	100	SMB
600	26	1	SMBJ26A-TR	SMBJ26CA-TR	28.9	1	42.1	14.9	100	SMB
600	28	1	SMBJ28A-TR	SMBJ28CA-TR	31.1	1	45.4	13.8	100	SMB
600	30	1	SMBJ30A-TR	SMBJ30CA-TR	33.3	1	48.4	13	100	SMB
600	33	1	SMBJ33A-TR	SMBJ33CA-TR	36.7	1	53.3	11.8	100	SMB
600	40	1	SMBJ40A-TR	SMBJ40CA-TR	44.4	1	64.5	9.7	100	SMB
600	48	1	SMBJ48A-TR	SMBJ48CA-TR	53.3	1	77.4	8.1	100	SMB
600	58	1	SMBJ58A-TR	SMBJ58CA-TR	64.4	1	93.6	6.7	100	SMB
600	70	1	SMBJ70A-TR	SMBJ70CA-TR	77.8	1	113	5.5	100	SMB
600	85	1	SMBJ85A-TR	SMBJ85CA-TR	94.4	1	137	4.6	100	SMB
600	130	1	SMBJ130A-TR	SMBJ130CA-TR	144	1	209	3	100	SMB
600	170	1	SMBJ170A-TR	SMBJ170CA-TR	189	1	275	2.2	100	SMB
600	188	1	SMBJ188A-TR	SMBJ188CA-TR	209	1	328	2	100	SMB

Power* (W)	V _{RM} (V)	I _{RM} max @ V _{RM} (µA)	Part number		V _{BR} min @ I _R		V _{CL} max @ IPP		I _{FSM} (A)	Package
			Unidirect.	Bidirect.	(V)	(mA)	(V)	(A)		
High-temperature 600W transils – SMB										
600	20.5	2	SM6HT24A		22.8	1	33.2	18	75	SMB
600	23.1	2	SM6HT27A		25.7	1	37.5	16	75	SMB
600	25.6	2	SM6HT30A		28.5	1	41.5	14.5	75	SMB
600	30.8	2	SM6HT36A		34.2	1	49.9	12	75	SMB
600	33.3	2	SM6HT39A		37.1	1	53.9	11.1	75	SMB
600	36.8	2	SM6HT43A		40.9	1	59.3	10.1	75	SMB
Digital purpose 600W transils – SMB										
600	3.3	200	SMLVT3V3		4.1	1	7.3	50	50	SMB
600	12	1	SMBJ12AVCL		13.2	1	15.8	17.5	50	SMB

* 10/1000µs waveform

EOS and ESD transient voltage suppressor: Transil

Power* (W)	V _{RM} (V)	I _{RM} max @ V _{RM} (µA)	Part number		V _{BR} min @ I _R		V _{CL} max @ I _{PP}		I _{FSM} (A)	Package
			Unidirect.	Bidirect.	(V)	(mA)	(V)	(A)		
1500W Transils – Axial										
1500	5	300	1N5908	-	6	1	7.6	30	200	DO-201
1500	5.8	1000	1.5KE6V8A	1.5KE6V8CA	6.45	10	10.5	143	200	DO-201
1500	6.4	500	1.5KE7V5A	1.5KE7V5CA	7.13	10	11.3	132	200	DO-201
1500	10.2	5	1.5KE12A	1.5KE12CA	11.4	1	16.7	90	200	DO-201
1500	12.8	1	1.5KE15A	1.5KE15CA	14.3	1	21.2	71	200	DO-201
1500	15.3	1	1.5KE18A	1.5KE18CA	17.1	1	25.2	59.5	200	DO-201
1500	18.8	1	1.5KE22A	1.5KE22CA	20.9	1	30.6	49	200	DO-201
1500	20.5	1	1.5KE24A	1.5KE24CA	22.8	1	33.2	45	200	DO-201
1500	25.6	1	1.5KE30A	1.5KE30CA	28.5	1	41.5	36	200	DO-201
1500	28.2	1	1.5KE33A	1.5KE33CA	31.4	1	45.7	33	200	DO-201
1500	30.8	1	1.5KE36A	1.5KE36CA	34.2	1	49.9	30	200	DO-201
1500	33.3	1	1.5KE39A	1.5KE39CA	37.1	1	53.9	28	200	DO-201
1500	40.2	1	1.5KE47A	1.5KE47CA	44.7	1	64.3	23.2	200	DO-201
1500	47.8	1	1.5KE56A	1.5KE56CA	53.2	1	77	19.5	200	DO-201
1500	53	1	1.5KE62A	1.5KE62CA	58.9	1	85	17.7	200	DO-201
1500	58.1	1	1.5KE68A	1.5KE68CA	64.6	1	92	16.3	200	DO-201
1500	70.1	1	1.5KE82A	1.5KE82CA	77.9	1	113	13.3	200	DO-201
1500	85.5	1	1.5KE100A	1.5KE100CA	95	1	137	11	200	DO-201
1500	154	1	1.5KE180A	1.5KE180CA	171	1	246	6.1	200	DO-201
1500	171	1	1.5KE200A	1.5KE200CA	190	1	274	5.5	200	DO-201
1500	188	1	1.5KE220A	1.5KE220CA	209	1	328	4.6	200	DO-201
1500	213	1	1.5KE250A	1.5KE250CA	237	1	344	5	200	DO-201
1500	256	1	1.5KE300A	1.5KE300CA	285	1	414	5	200	DO-201
1500	299	1	1.5KE350A	1.5KE350CA	332	1	482	4	200	DO-201
1500	342	1	1.5KE400A	1.5KE400CA	380	1	548	4	200	DO-201
1500	376	1	1.5KE440A	1.5KE440CA	418	1	603	3.5	200	DO-201
1500W Transils – SMC										
1500	5	300	SM5908	-	6	1	7.6	30	200	SMC
1500	5.8	1000	SM15T6V8A	SM15T6V8CA	6.45	10	10.5	143	200	SMC
1500	6.4	500	SM15T7V5A	SM15T7V5CA	7.13	10	11.3	132	200	SMC
1500	8.55	10	SM15T10A	SM15T10CA	9.5	1	14.5	103	200	SMC
1500	10.2	5	SM15T12A	SM15T12CA	11.4	1	16.7	90	200	SMC
1500	12.8	5	SM15T15A	SM15T15CA	14.3	1	21.2	71	200	SMC
1500	15.3	5	SM15T18A	SM15T18CA	17.1	1	25.2	59.5	200	SMC
1500	18.8	5	SM15T22A	SM15T22CA	20.9	1	30.6	49	200	SMC
1500	20.5	5	SM15T24A	SM15T24CA	22.8	1	33.2	45	200	SMC
1500	23.1	5	SM15T27A	SM15T27CA	25.7	1	37.5	40	200	SMC
1500	25.6	5	SM15T30A	SM15T30CA	28.5	1	41.5	36	200	SMC
1500	28.2	5	SM15T33A	SM15T33CA	31.4	1	45.7	33	200	SMC
1500	30.8	5	SM15T36A	SM15T36CA	34.2	1	49.9	30	200	SMC
1500	33.3	5	SM15T39A	SM15T39CA	37.1	1	53.9	28	200	SMC
1500	58.1	5	SM15T68A	SM15T68CA	64.6	1	92	16.3	200	SMC
1500	85.5	5	SM15T100A	SM15T100CA	95	1	137	11	200	SMC
1500	128	5	SM15T150A	SM15T150CA	143	1	207	7.2	200	SMC
1500	171	5	SM15T200A	SM15T200CA	190	1	274	5.5	200	SMC
1500	188	5	SM15T220A	SM15T220CA	209	1	328	4.6	200	SMC
1500	5	800	SMCJ5.0A-TR	SMCJ5.0CA-TR	6.4	10	9.2	171	200	SMC
1500	6	800	SMCJ6.0A-TR	SMCJ6.0CA-TR	6.7	10	10.3	152	200	SMC
1500	6.5	500	SMCJ6.5A-TR	SMCJ6.5CA-TR	7.2	10	11.2	140	200	SMC
1500	10	5	SMCJ10A-TR	SMCJ10CA-TR	11.1	1	17	92	200	SMC
1500	12	5	SMCJ12A-TR	SMCJ12CA-TR	13.3	1	19.9	79	200	SMC
1500	13	1	SMCJ13A-TR	SMCJ13CA-TR	14.4	1	21.5	73	200	SMC
1500	15	1	SMCJ15A-TR	SMCJ15CA-TR	16.7	1	24.4	64	200	SMC
1500	18	1	SMCJ18A-TR	SMCJ18CA-TR	20	1	29.2	53	200	SMC
1500	22	1	SMCJ22A-TR	SMCJ22CA-TR	24.4	1	35.5	44	200	SMC
1500	24	1	SMCJ24A-TR	SMCJ24CA-TR	26.7	1	38.9	40	200	SMC
1500	26	1	SMCJ26A-TR	SMCJ26CA-TR	28.9	1	42.1	37	200	SMC
1500	28	1	SMCJ28A-TR	SMCJ28CA-TR	31.1	1	45.4	34	200	SMC
1500	30	1	SMCJ30A-TR	SMCJ30CA-TR	33.3	1	48.4	32	200	SMC
1500	33	1	SMCJ33A-TR	SMCJ33CA-TR	36.7	1	53.3	29	200	SMC
1500	40	1	SMCJ40A-TR	SMCJ40CA-TR	44.4	1	64.5	24	200	SMC
1500	48	1	SMCJ48A-TR	SMCJ48CA-TR	53.3	1	77.4	20	200	SMC
1500	58	1	SMCJ58A-TR	SMCJ58CA-TR	64.4	1	93.6	16	200	SMC
1500	70	1	SMCJ70A-TR	SMCJ70CA-TR	77.8	1	113	13.9	200	SMC
1500	85	1	SMCJ85A-TR	SMCJ85CA-TR	94.4	1	137	11.5	200	SMC
1500	130	1	SMCJ130A-TR	SMCJ130CA-TR	144	1	209	7.5	200	SMC
1500	170	1	SMCJ170A-TR	SMCJ170CA-TR	189	1	275	5.7	200	SMC
1500	188	1	SMCJ188A-TR	SMCJ188CA-TR	209	1	328	4.6	200	SMC

* 10/1000µs waveform

ESD protection

EOS and ESD transient voltage suppressor: Transil

Power* (W)	V _{RM} (V)	I _{RM} max @ V _{RM} (μA)	Part number		V _{BR} min @ I _R		V _{CL} max @ I _{pp}		I _{FSM} (A)	Package
			Unidirect.	Bidirect.	(V)	(mA)	(V)	(A)		
5000W Transils – Axial										
5000	10	5	BZW50-10	BZW50-10B	11.1	1	18.8	266	500	R6
5000	15	5	BZW50-15	BZW50-15B	16.6	1	26.9	186	500	R6
5000	22	5	BZW50-22	BZW50-22B	24.4	1	39.4	127	500	R6
5000	27	5	BZW50-27	BZW50-27B	30	1	48.3	103	500	R6
5000	33	5	BZW50-33	BZW50-33B	36.6	1	59	85	500	R6
5000	39	5	BZW50-39	BZW50-39B	43.3	1	69.4	72	500	R6
5000	56	5	BZW50-56	BZW50-56B	62.2	1	99.6	50	500	R6
5000	68	5	BZW50-68	BZW50-68B	75.6	1	121	41	500	R6
5000	82	5	BZW50-82	BZW50-82B	91	1	145	34	500	R6
5000	100	5	BZW50-100	BZW50-100B	111	1	179	28	500	R6
5000	150	5	BZW50-150	BZW50-150B	166	1	269	19	500	R6
5000	180	5	BZW50-180	BZW50-180B	200	1	322	16	500	R6

Part number	V _{RM} (V)	I _{RM} max T _c = 25°C (mA)	I _{RM} max T _c = 85°C (mA)	V _{BR} min T _c = 25°C (V)	V _{BR} max T _c = 25°C (V)	I _R T _c = 25°C (mA)	V _{CL} max T _c = 25°C (V)	I _{pp} T _c = 25°C (A)	C typ (nF)	Package
Automotive Transils – Axial										
LDP24A	24	50	300	25	32	1	38	30	8	R6

Data protection against ESD

ESD unidirectional diodes array

Number of lines	V _{RM} (V)	I _{RM} max @ V _{RM} (μA)	Part number	V _{BR} min @ I _R		R _d typ (mΩ)	C typ @ 0Vbias (pF)	Package
				(V)	(mA)			
ESD unidirectional diodes array								
1	10	0.5	ESDA18-1F2	16	1		230	Flip-Chip
2	12	5	ESDA14V2L	14.2	1	650	90	SOT-23
2	24	1	ESDA25W	25	1	1100	65	SOT323-3L
2	3	1	ESDA6V1DCB	6.1	1	500	155	QFN
2	3	0.1	ESDA14V2DCB	14.2	1	800	80	QFN
2	3	2	ESDA5V3L	5.3	1	280	220	SOT-23
2	5.25	20	ESDA6V1L	6.1	1	350	140	SOT-23
2	3	0.1	ESDALC6V1P3	6.1	1	1500 (max)	12	SC89-3L
2	5	0.5	ESDALC6V1M3	6.1	1	1100	11	SOT883
4	3	0.5	ESDA6V1M6	6.1	1	1000	70	Micro QFN
4	3	0.07	ESDALC6V1M6	6.1	1	2000	12	Micro QFN
4	12	5	ESDA14V2SC5	14.2	1	650	100	SOT23-5L
4	14	0.075	ESDA17SC6	17	1	700	85	SOT23-6L
4	15	0.1	ESDA19SC6	19	1	800	80	SOT23-6L
4	24	1	ESDA25SC6	25	1	1000	60	SOT23-6L
4	24	1	ESDA25W5	25	1	1900	30	SOT323-3L
4	3	2	ESDA5V3SC5	5.3	1	230	280	SOT23-5L
4	3	2	ESDA5V3SC6	5.3	1	230	280	SOT23-6L
4	5	10	ESDA6V1-4F1	6.1	1	350	250 (max)	Flip-Chip
4	3	0.5	ESDA6V1P6	6.1	1	1500	70	SOT-666
4	5.25	20	ESDA6V1SC5	6.1	1	350	190	SOT23-5L
4	5.25	20	ESDA6V1SC6	6.1	1	350	190	SOT23-6L
4	3	1	ESDA6V1W5	6.1	1	350	90	SOT323-5L
4	3	0.5	ESDALC6V1P6	6.1	1	1500	12	SOT-666
4	3	1	ESDALC6V1W5	6.1	1	1100	12	SOT323-5L
4	3	0.5	ESDALC6V1P5	6.1	1	1500	12	SOT665-5L
4	3	0.5	ESDALC6V1F1	6.1	1	1000	12	Flip-Chip
5	3	0.5	ESDA6V1-5M6	6.1	1	1000	70	Micro QFN
5	3	0.07	ESDALC6V1-5M6	6.1	1	2000	12	Micro QFN
5	3	0.5	ESDA6V1-5P6	6.1	1	1500	70	SOT-666
5	14	0.075	ESDA17-5SC6	17	1	1000	35	SOT23-6L
5	15	0.1	ESDA19-5SC6	19	1	1000	35	SOT23-6L
5	3	1	ESDA6V1-5W6	6.1	1	610	50	SOT323-6L
6	5	2	ESDA6V1U1	6.1	1	500	100	SO-8
18	5	2	ESDA6V1S3	6.1	1	500	120	SO20

* 10/1000μs waveform

Data protection against ESD

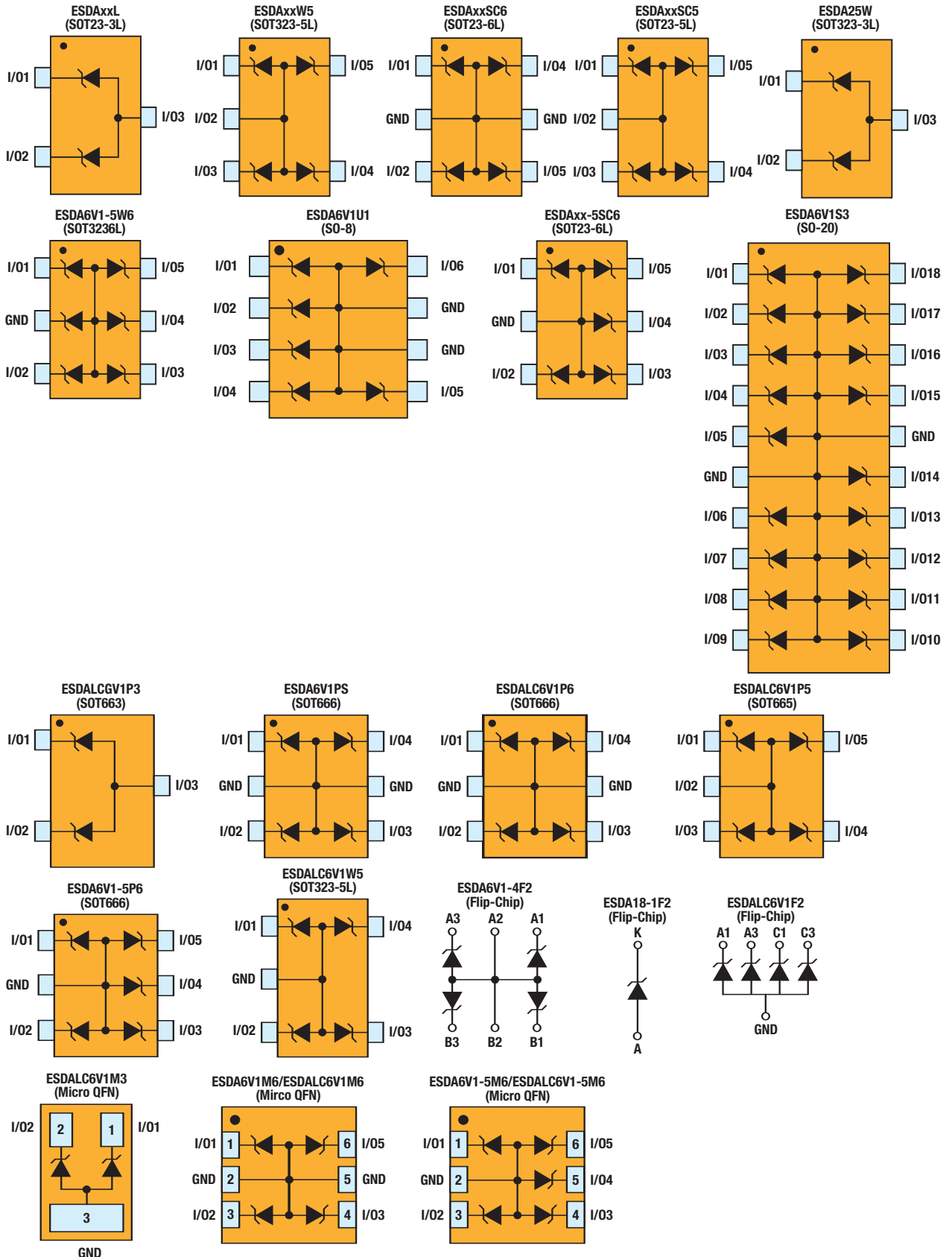

ESD unidirectional suppressors

ESD protection

Data protection against ESD

ESD bidirectional diodes array

Number of lines	V_{RM} (V)	I_{RM} max @ V_{RM} (μ A)	Part number	V_{BR} min @ I_R		R_d typ ($m\Omega$)	C typ @ 0Vbias (pF)	Package
				(V)	(mA)			
ESD bidirectional diodes array								
4	12	1	ESDA14V2-4BF1	14.2	1	3200	15 (max)	Flip-Chip
4	12	1	ESDA14V2-4BF2	14.2	1	3200	15 (max)	Flip-Chip
4	12	0.5	ESDA14V2-4BF3	14.2	1	3200	15 (max)	Flip-Chip
4	12	1	ESDA14V2-BP6	14.2	1	1500	20	SOT-666
4	3	1	ESDA6V1-4BF1	6.1	1	1100	35	Flip-Chip
4	3	1	ESDA6V1-4BC6	6.1	1	450	45	SOT23-6L
4	5	1	ESDA6V1BC6	6.1	1	1350	20	SOT23-6L
6	24	2	ESDA25B1	25	1	1500	15	SO-8
6	3	2	ESDA6V1B1	6.1	1	700	50	SO-8
2	12	1	ESDALC14V2-2BP5	14.2	1	15000	21	SOT-665
2	24	1	ESDALC25-2BP5	25	1	1300	15	SOT-665

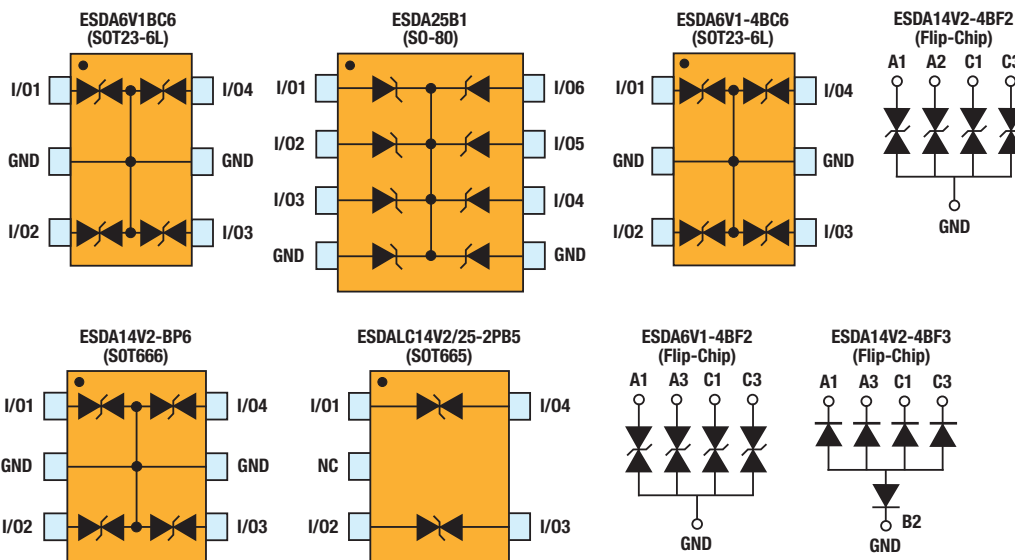

ESD bidirectional suppressors

USB port protection

Array function	Part number	V_{RM} (V)	I_{RM} max @ V_{RM} (μ A)	V_{BR} max @ I_R		C typ (pF)	Package
				(V)	(A)		
USB port protection							
USB 1.1 port protection	USB6B1	5.25	10	6	1	15	SO-8
USB 2.0 port protection	USBLC6-4SC6	5	2	6	1	3	SOT23-6L
USB 2.0 port protection	USBLC6-2SC6	5	1	6	1	2.5	SOT23-6L
USB 2.0 port protection	USBLC6-2P6	5	1	6	1	2.5	SOT666

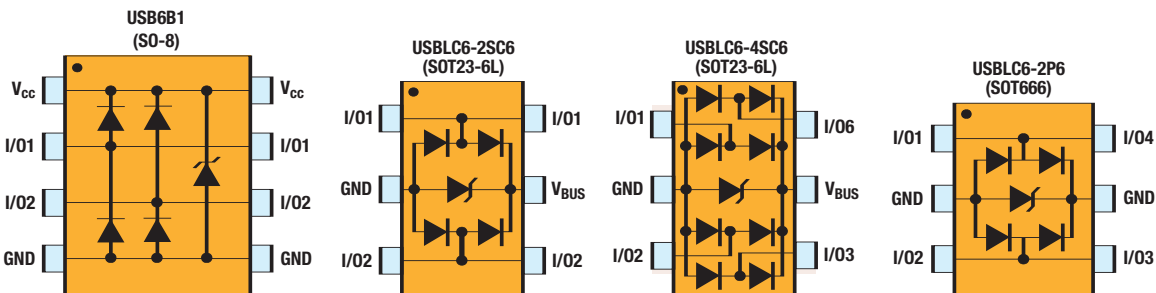

USB port protection suppressors

ESD protection

Data protection against ESD

Rail-to-rail protection for xDSL, modem and ethernet

Array function	Part number	V_{RRM} (V)	I_R max @ 15V (μ A)	C max @ 5V (pF)	V_F max @ 50mA (V)	IEC61000-4-2 Std level	HBM Mil Std 883E class	Package
Rail-to-rail protection for xDSL, modem and ethernet								
Rail-to-rail 4-line	DA108S1RL	18	2	35	1.2	4	3	SO-8
Rail-to-rail 6-line	DA112S1RL	18	2	35	1.2	4	3	SO-8
R.-to-r. 6-line low capa.	DALC112S1	18	2	7	1.3	3	3	SO-8
R.-to-r. 6-line low capa.	DALC112S1RL	18	2	7	1.3	3	3	SO-8
R.-to-r. 4-line low capa.	DALC208SC6	9	1	7	1.2	4	3	SOT23 - 6L

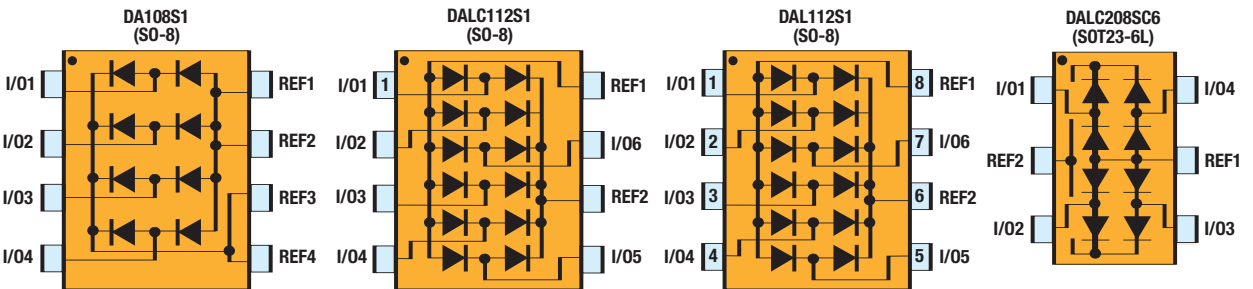

Rail-to-rail suppressors

High speed interface protection

Number of lines	Part number	V_{RM} (V)	I_{RM} max @ V_{RM} (μ A)	V_{BR} min @ I_R		C typ* (pF)	C typ** (pF)	Package
				(V)	(mA)			
High speed interfaces protection								
4	DVIULC6-4SC6	5	5	6	1	0.85	0.42	SOT23-6L
4	HDMIULC6-4SC6	5	5	6	1	0.85	0.42	SOT23-6L

* Capacitance between I/O and GND

** Capacitance between I/O

DVIULC6-4SC6/HDMIULC6-4SC6 (SOT23-6L)

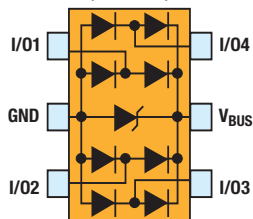

High speed lines suppressors

Telecom protection

Standards

ST protection devices address many applications governed by different standards: All telecom equipment is potentially susceptible to the effects of lightning strikes and power crossing with mains lines. The main worldwide standards for telecom lines are shown below. These are covered by the Trisil (pages 17 to 18) and Protection IC families (pages 19 to 23).

Standard	Peak surge voltage	Waveform voltage	Required peak current	Current waveform	Application
	(V)	(μ s)	(A)	(μ s)	
GR-1089 Core first level	2500	2/10	500	2/10	Central offices
GR-1089 Core second level	1000	10/1000	100	10/1000	
GR-1089 Core second level	5000	2/10	500	2/10	
ITU-T-K20 (IEC61000-4-2)	8000	1/60	ESD contact discharge ESD air discharge		
ITU-T-K20 (IEC61000-4-2)	15000				
VDE0433	4000	10/700	100	5/310	
VDE0433	2000	10/700	50	5/310	
VDE0878	4000	1.2/50	100	1/20	
VDE0878	2000	1.2/50	50	1/20	
IEC61000-4-5	4000	10/700	100	5/310	
IEC61000-4-5	4000	1.2/50	100	8/20	
ITU-T-K20/K21	6000	10/700	150	5/310	Central offices and terminals
ITU-T-K20/K21	1500	10/700	37.5	5/310	Central offices and terminals
FCC part 68, lightning surge type A	1500	10/160	200	10/160	Terminals
FCC part 68, lightning surge type A	800	10/560	100	10/560	Terminals
FCC part 68, lightning surge type B	1000	9/720	25	5/320	Terminals
GR-1089 Core intra-building	1500	2/10	100	2/10	Intra-building

Surge protection: Trisil™

What is a Trisil?

Trisils belong to the category of crowbar protection devices. When the voltage across the trisil goes above the V_{BO} , the device is triggered and becomes a low impedance path through which the over-charge can be diverted. By operating in short circuit mode, as shown in the I/V curve presented below, the crowbar protection devices combine a high surge capability with small package size.

How to choose a Trisil?

- The previous table indicates the relationship between the standards and the application.
- The V_R value must be higher than the operating voltage to avoid triggering the protection during normal operation.
- The maximum V_{BO} (breakover voltage) has to be lower than the destruction threshold of the sensitive device being protected.
- ST recommends the most suitable value for the series resistor to place on the line, when needed, to comply with the various standards.

Trisil protection is also exposed to power crossing events. In such cases, a fuse or PTC should be placed on the line to open the circuit and limit the current, as shown in the diagram.

I/V Trisil characteristics

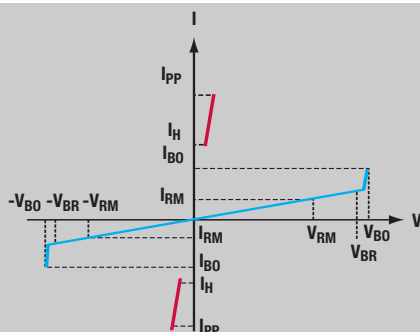

Telecom line protection with Trisil

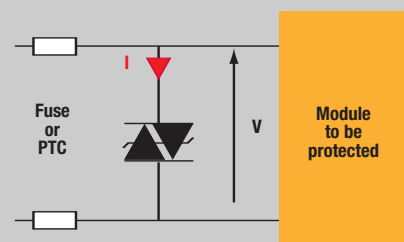

Surge protection: Trisil

High energy crowbar protection

By operating in short circuit mode, crowbar protection devices combine every high surge capability with small package size. This kind of suppressor is used in telecom applications.

I _{pp} max* (A)	V _{RM} (V)	I _{RM} max @ V _{RM} (μA)	Part number	V _R @ I _R		V _{BO} max @ I _{BO}		I _H min (mA)	C typ @ V _R =2V (pF)	Package
				(V)	(μA)	(V)	(mA)			
Trisils for telecom intrabuilding and terminals – SMA										
30	56	2	SMP30-62	62	5	82	800	150	40	SMA
30	61	2	SMP30-68	68	5	90	800	150	40	SMA
30	90	2	SMP30-100	100	5	133	800	150	35	SMA
30	108	2	SMP30-120	120	5	160	800	150	30	SMA
30	117	2	SMP30-130	130	5	173	800	150	30	SMA
30	162	2	SMP30-180	180	5	240	800	150	25	SMA
30	180	2	SMP30-200	200	5	267	800	150	25	SMA
30	198	2	SMP30-220	220	5	293	800	150	20	SMA
30	216	2	SMP30-240	240	5	320	800	150	20	SMA
30	243	2	SMP30-270	270	5	360	800	150	20	SMA
Trisils for telecom terminals – SMA										
50	56	2	SMP50-62	62	5	82	800	150	40	SMA
50	61	2	SMP50-68	68	5	90	800	150	40	SMA
50	90	2	SMP50-100	100	5	133	800	150	35	SMA
50	108	2	SMP50-120	120	5	160	800	150	30	SMA
50	117	2	SMP50-130	130	5	173	800	150	30	SMA
50	162	2	SMP50-180	180	5	240	800	150	25	SMA
50	180	2	SMP50-200	200	5	267	800	150	25	SMA
50	198	2	SMP50-220	220	5	293	800	150	25	SMA
50	216	2	SMP50-240	240	5	320	800	150	25	SMA
50	243	2	SMP50-270	270	5	360	800	150	25	SMA
Trisils for telecom terminals – SMB										
50	56	2	SMTPA62	62	5	82	800	150	40	SMB
50	61	2	SMTPA68	68	5	90	800	150	40	SMB
50	90	2	SMTPA100	100	5	133	800	150	35	SMB
50	108	2	SMTPA120	120	5	160	800	150	30	SMB
50	117	2	SMTPA130	130	5	173	800	150	30	SMB
50	62	2	SMTPA180	180	5	240	800	150	25	SMB
50	180	2	SMTPA200	200	5	267	800	150	25	SMB
50	198	2	SMTPA220	220	5	293	800	150	25	SMB
50	216	2	SMTPA240	240	5	320	800	150	25	SMB
50	243	2	SMTPA270	270	5	360	800	150	25	SMB
Trisils for telecom terminals – Axial										
50	56	2	TPA62	62	5	82	800	150	40	DO-15
50	90	2	TPA100	100	5	133	800	150	40	DO-15
50	108	2	TPA120	120	5	160	800	150	35	DO-15
50	117	2	TPA130	130	5	173	800	150	30	DO-15
50	162	2	TPA180	180	5	240	800	150	30	DO-15
50	180	2	TPA200	200	5	267	800	150	25	DO-15
50	198	2	TPA220	220	5	293	800	150	25	DO-15
50	216	2	TPA240	240	5	320	800	150	25	DO-15
50	243	2	TPA270	270	5	360	800	150	25	DO-15
Trisils for telecom equipment – SMB										
75	6	2	SMP75-8	8	5	15	800	50 (typ)	75	SMB
80	108	2	SMP80MC-120	120	5	155	800	150	25	SMB
80	126	2	SMP80MC-140	140	5	180	800	150	25	SMB
80	144	2	SMP80MC-160	160	5	205	800	150	25	SMB
80	180	2	SMP80MC-200	200	5	255	800	150	25	SMB
80	207	2	SMP80MC-230	230	5	295	800	150	25	SMB
80	243	2	SMP80MC-270	270	5	345	800	150	25	SMB
100	126	2	SMP100MC-140	140	5	180	800	150	60	SMB
100	144	2	SMP100MC-160	160	5	205	800	150	50	SMB
100	180	2	SMP100MC-200	200	5	255	800	150	45	SMB
100	207	2	SMP100MC-230	230	5	295	800	150	40	SMB
100	243	2	SMP100MC-270	270	5	345	800	150	40	SMB
100	290	2	SMP100MC-320	320	5	400	800	150	35	SMB
100	325	2	SMP100MC-360	360	5	460	800	150	35	SMB
100	360	2	SMP100MC-400	400	5	540	800	150	30	SMB

* 10/1000μs waveform

Telecom protection

Surge protection: Trisil

$I_{PP} \text{ max}^*$ (A)	V_{RM} (V)	$I_{RM} \text{ max @}$ V_{RM} (μA)	Part number	$V_R @ I_R$		$V_{BO} \text{ max @ } I_{BO}$		$I_H \text{ min}$ (mA)	C typ @ $V_R=2\text{V}$ (pF)	Package
				(V)	(μA)	(V)	(mA)			
Trisils for telecom equipment – SMB										
100	6	2	SMP100LC-8	8	5	25	800	50 (typ)	75	SMB
100	22	2	SMP100LC-25	25	5	40	800	150	65	SMB
100	32	2	SMP100LC-35	35	5	55	800	150	55	SMB
100	55	2	SMP100LC-65	65	5	85	800	150	90	SMB
100	81	2	SMP100LC-90	90	5	125	800	150	80	SMB
100	108	2	SMP100LC-120	120	5	160	800	150	75	SMB
100	126	2	SMP100LC-140	140	5	190	800	150	65	SMB
100	144	2	SMP100LC-160	160	5	205	800	150	65	SMB
100	180	2	SMP100LC-200	200	5	255	800	150	60	SMB
100	207	2	SMP100LC-230	230	5	295	800	150	60	SMB
100	243	2	SMP100LC-270	270	5	345	800	150	60	SMB
100	290	2	SMP100LC-320	320	5	400	800	150	50	SMB
100	325	2	SMP100LC-360	360	5	460	800	150	50	SMB
100	360	2	SMP100LC-400	400	5	540	800	150	45	SMB

* 10/1000 μs waveform

Protection ICs:

Telecom line topology

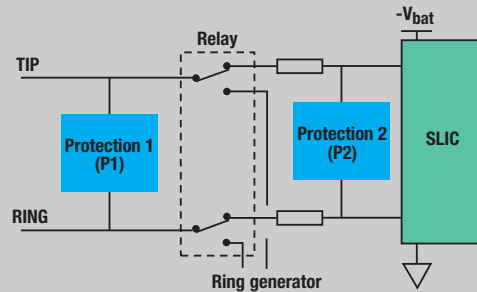

Fixed voltage protection for telecom solid state relay (P1)

$I_{PP} \text{ max}^*$ (A)	Part number	$V_R @ I_R$		$V_{BO} \text{ max @}$ (50Hz) (V)	$I_H \text{ min}$ (mA)	Package
		(V)	(μA)			
Fixed voltage protection for telecom solid state relay						
2x35	SSRP105B1	+ 105/-180	10	+ 165/-225	150 (neg polarity) /100 (pos polarity)	SO-8
2x15	SSRP130B1	+ 130/-185	10	+ 200/-280	150	SO-8

* 10/1000 μs waveform

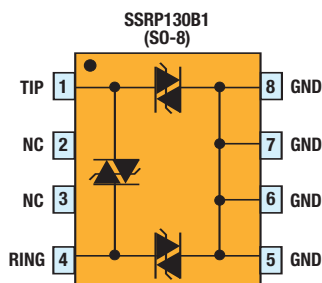

Protection ICs:

Fixed voltage protection for telecom relay (P1)

$I_{PP} \text{ max}^*$ (A)	V_{RM} (V)	$I_{RM} \text{ max @}$ V_{RM} (μA)	Part number	$V_R \text{ min @ } I_R$		$V_{BO} \text{ max @ } I_{BO}$		$I_H \text{ min}$ (mA)	Package
				(V)	(μA)	(V)	(mA)		
Fixed voltage protection for telecom relay									
30	135	5	THBT15011D	150	50	210	400	150	SO-8
30	135	5	THBT16011D	160	50	230	400	150	SO-8
30	180	5	THBT20011D	200	50	290	400	150	SO-8
30	240	5	THBT27011D	270	50	380	400	150	SO-8
100	120	5	TLP140G	140	50	200	500	150	D ² PAK
100	120	5	TLP140G-1	140	50	200	500	150	I ² PAK
100	180	5	TLP200G	200	50	290	500	150	D ² PAK
100	180	5	TLP200G-1	200	50	290	500	150	I ² PAK
100	230	5	TLP270G	270	50	400	500	150	D ² PAK
100	230	5	TLP270G-1	270	50	400	500	150	I ² PAK

* 10/1000 μs waveform

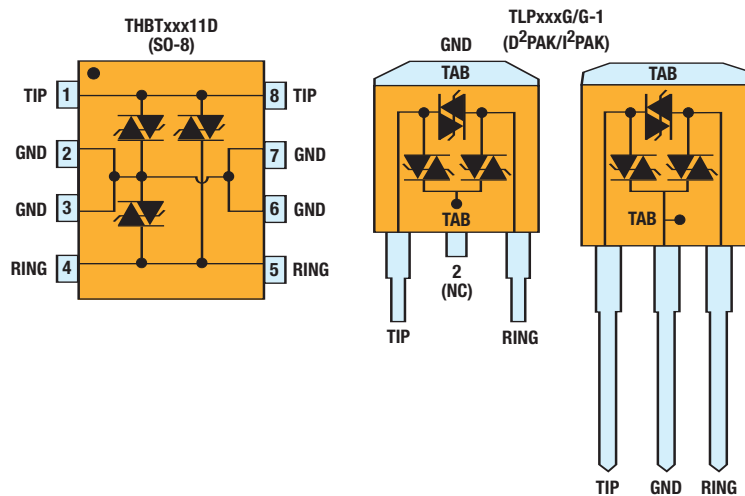

SLIC protection fixed breakdown voltage (P2)

$I_{PP} \text{ max}^*$ (A)	V_{RM} (V)	$I_{RM} \text{ max @}$ V_{RM}	Part number	$V_R \text{ @ } I_R$		$V_{BO} \text{ max (V)}$	$I_H \text{ min}$ (mA)	Package
				(V)	(mA)			
Fixed voltage protection for telecom relay								
40	63	100	THDT6511D	65	1	85	150	SO-8

* 10/1000 μs waveform

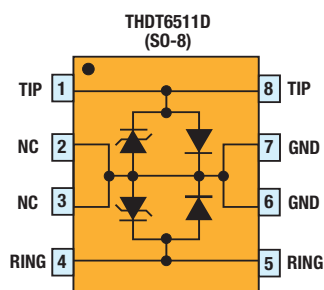

Telecom protection

Protection ICs:

SLIC protection programmable breakdown voltage (P2)

$I_{PP} \text{ max}^*$ (A)	Part number	V_{RM} (V)	$I_{RM} \text{ max @ } V_{RM}$ (μA)	Max oper. voltage (V)	$V_{DGL} \text{ max}$ (10/700ms) (V)	$I_H \text{ min}$ (mA)	Package
Protection ICs programmable voltage SLIC protection							
2x15	LCDP1521	150	5	150	5	150	SO-8
30	LCP02-150B1	-105/90	5	-110 to +95	8	150	SO-8 wide
100	LCP02-150M	-105/90	5	-110 to +95	6(+ suppressor) /8 (- suppressor)	150	PowerSO-10
30	LCP1521S	150	5	150	7	150	SO-8
30	LCP152DEE	150	5	150	7	150	QFN 3x3
100	LCP3121	60	5	80		100	SO-8

* 10/1000 μs waveform

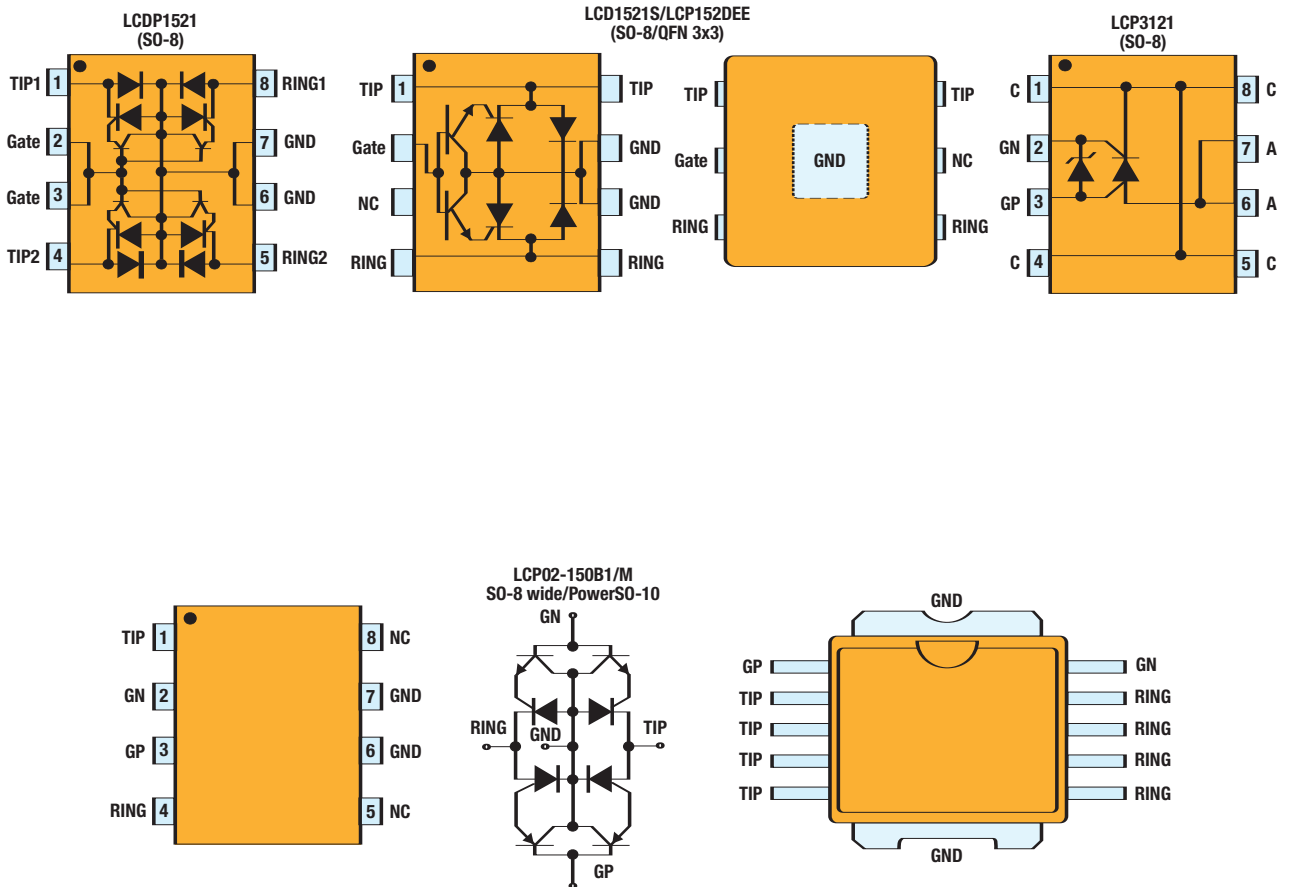

Protection ICs:

Protection ICs programmable current and voltage line card protection

$I_{PP} \text{ max}^*$ (A)	V_{LG} (V)	$I_{LGL} \text{ max @ } V_{GL}$ (μA)	Part number	$V_{\text{ref min @ } V_{GL}}$		$V_{\text{SWON max @ } I_{\text{SWOFF min}}}$		Package
				(V)	(mA)	(V)	(mA)	
Protection ICs programmable current and voltage line card protection								
30	200	10	CLP30-200B1			290	50	SO-8
100	200	10	CLP200M	215	1	290	150	PowerSO-10
100	240	10	CLP270M	270	1	380	150	PowerSO-10

* 10/1000 μs waveform

CLP30-200B1/CLP200M/CLP270M
(SO-8/PowerSO-10)

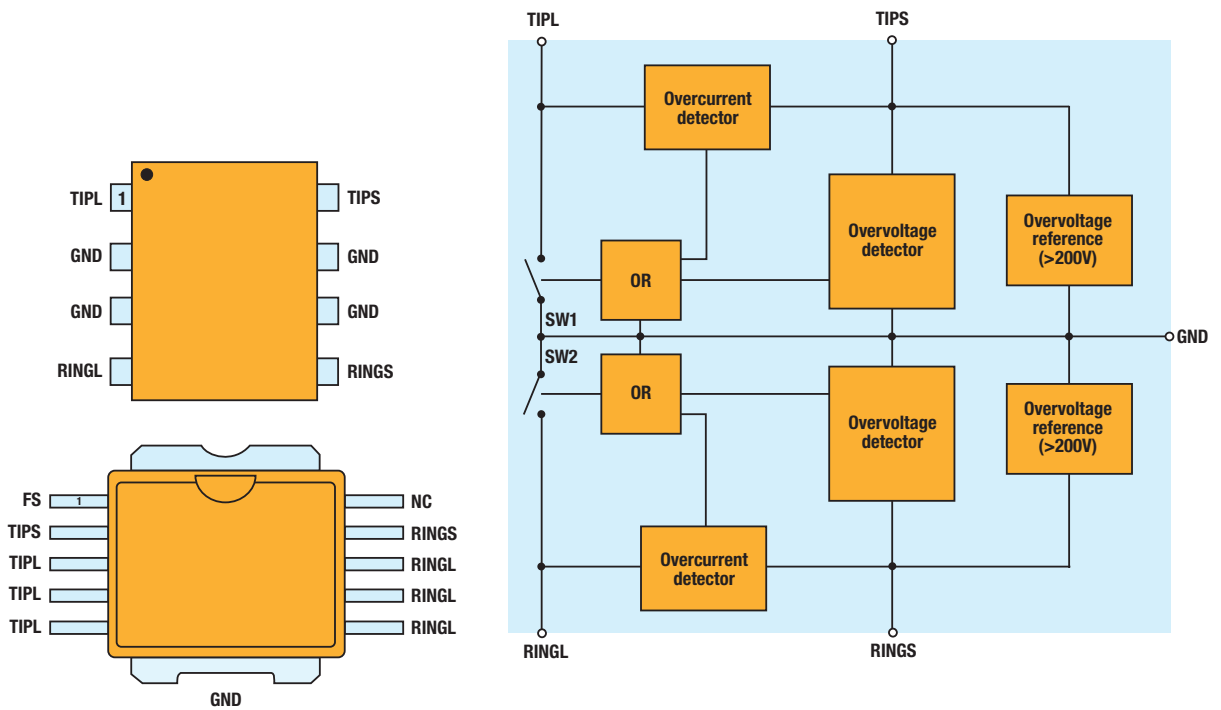

ISDN S and U interface protection

$I_{PP} \text{ max}^*$ (A)	V_{RM} (V)	$I_{RM} \text{ max @ } V_{RM}$ (μA)	Part number	$V_{BR} \text{ min @ } I_R$		$V_{BO} \text{ max @ } I_{BO}$		$I_H \text{ min (mA)}$	Package
				(V)	(mA)	(V)	(mA)		
ISDN S and U interface protection									
30	70	10	TPI8011N	80	1	120	800	150	SO-8
30	105	10	TPI12011N	120	1	180	800	150	SO-8

* 10/1000 μs waveform

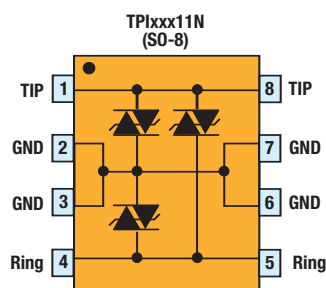

Telecom protection

Protection ICs:

T1/E1 interface protection

$I_{PP} \text{ max}^*$ (A)	V_{RM} (V)	$I_{RM} \text{ max @ } V_{RM}$ (μA)	Part number	$V_{BO} \text{ max @ } I_{BO}$		$I_H \text{ min}$ (mA)	Package
				(V)	(mA)		
T1/E1 interface protection							
30	28	4	TPN3021	38	300	30	SO-8

* 10/1000 μs waveform

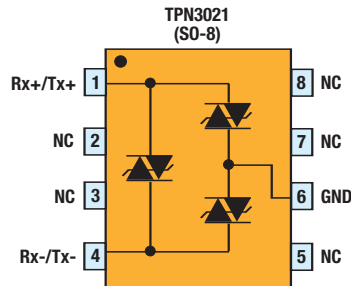

ISDN S and U interface protection

$I_{PP} \text{ max}^*$ (A)	V_{RM} (V)	$I_{RM} \text{ max @ } V_{RM}$ (μA)	Part number	$V_{BO} \text{ max @ } I_{BO}$		$I_H \text{ min}$ (mA)	Package
				(V)	(mA)		
Bridge and protection all-in-one for telecom terminals							
30	200	5	TSI200B1	290	400	150	SO-8
30	220	5	TSI220B1	330	400	150	SO-8

* 10/1000 μs waveform

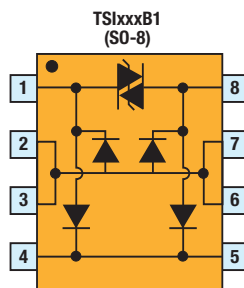

Overvoltage and overcurrent protection for telecom line

$I_{PP} \text{ max}^*$ (A)	V_{RM} (V)	$I_{RM} \text{ max @ } V_{RM}$ (μA)	Part number	$V_{BO} \text{ max @ } I_{BO}$		$I_H \text{ min}$ (mA)	Package
				(V)	(mA)		
Overvoltage and overcurrent protection for telecom line							
30	60	6	TPP25011	340	200	180	SO-8

* 10/1000 μs waveform

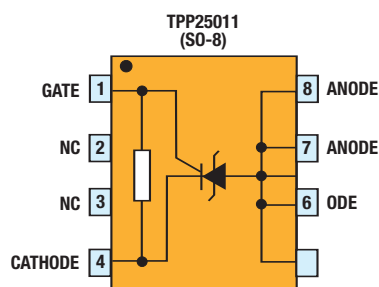

Cross-reference

Industry standard	ST part numbers	ST equivalence
1.0KE	1.5KE series	Direct
1.2KE	1.5KE series	Direct
1.4KESD	BZW04 series	Direct
1.5KA	1.5KE series	Nearest
1.5KE	1.5KE series	Direct
1.5SE	1.5KE series	Direct
1.5SMC10AT3	SM15T10A	Direct
1.5SMC11AT3	SM15T10A	Nearest
1.5SMC12AT3	SM15T12A	Direct
1.5SMC13AT3	SM15T12A	Nearest
1.5SMC15AT3	SM15T15A	Direct
1.5SMC16AT3	SM15T15A	Nearest
1.5SMC18AT3	SM15T18A	Direct
1.5SMC20AT3	SM15T18A	Nearest
1.5SMC22AT3	SM15T22A	Direct
1.5SMC24AT3	SM15T24A	Direct
1.5SMC27AT3	SM15T27A	Direct
1.5SMC30AT3	SM15T30A	Direct
1.5SMC33AT3	SM15T33A	Direct
1.5SMC36AT3	SM15T36A	Direct
1.5SMC39AT3	SM15T39A	Direct
1.5SMC43AT3	SM15T39A	Nearest
1.5SMC47AT3	SMCJ40A-TR	Nearest
1.5SMC51AT3	SMCJ40A-TR	Nearest
1.5SMC56AT3	SM15T68A	Nearest
1.5SMC6.8AT3	SM15T6V8A	Direct
1.5SMC62AT3	SM15T68A	Nearest
1.5SMC68AT3	SM15T68A	Direct
1.5SMC7.5AT3	SM15T7V5A	Direct
1.5SMC75AT3	SM15T100A	Nearest
1.5SMC8.2AT3	SM15T7V5A	Nearest
1.5SMC82AT3	SM15T100A	Direct
1.5SMC9.1AT3	SM15T10A	Nearest
1.5SMC91AT3	SM15T100A	Nearest
1SMA10AT3	SMAJ12A-TR	Nearest
1SMA10CAT3	SMAJ10CA-TR	Direct
1SMA11AT3	SMAJ12A-TR	Nearest
1SMA11CAT3	SMAJ10CA-TR	Nearest
1SMA12AT3	SMAJ12A-TR	Direct
1SMA12CAT3	SMAJ12CA-TR	Direct
1SMA13AT3	SMAJ13A-TR	Direct
1SMA13CAT3	SMAJ13CA-TR	Direct
1SMA14AT3	SMAJ13A-TR	Nearest
1SMA14CAT3	SMAJ13CA-TR	Nearest
1SMA15AT3	SMAJ15A-TR	Direct
1SMA15CAT3	SMAJ15CA-TR	Direct
1SMA16AT3	SMAJ15A-TR	Nearest
1SMA16CAT3	SMAJ15CA-TR	Nearest
1SMA17AT3	SMAJ15A-TR	Nearest
1SMA17CAT3	SMAJ15CA-TR	Nearest
1SMA18AT3	SMAJ18A-TR	Direct
1SMA18CAT3	SMAJ18CA-TR	Direct

Industry standard	ST part numbers	ST equivalence
1SMA20AT3	SM15T24A	Direct
1SMA20CAT3	SMAJ18CA-TR or SMAJ22CA-TR	Nearest
1SMA22AT3	SMAJ24A-TR	Nearest
1SMA22CAT3	SMAJ18CA-TR or SMAJ30CA-TR	Nearest
1SMA24AT3	SMAJ24A-TR	Direct
1SMA24CAT3	SMAJ18CA-TR or SMAJ30CA-TR	Nearest
1SMA26AT3	SMAJ26A-TR	Direct
1SMA26CAT3	SMAJ18CA-TR or SMAJ30CA-TR	Nearest
1SMA28AT3	SMAJ28A-TR	Direct
1SMA28CAT3	SMAJ28CA-TR	Direct
1SMA30AT3	SMAJ30A-TR	Direct
1SMA30CAT3	SMAJ30CA-TR	Direct
1SMA33AT3	SMAJ33A-TR	Direct
1SMA33CAT3	SMAJ33CA-TR	Direct
1SMA36AT3	SMAJ33A-TR	Nearest
1SMA36CAT3	SMAJ33CA-TR	Nearest
1SMA40AT3	SMAJ40A-TR	Direct
1SMA40CAT3	SMAJ40CA-TR	Direct
1SMA43AT3	SMAJ43A-TR	Direct
1SMA43CAT3	SMAJ43CA-TR	Direct
1SMA45AT3	SMAJ43A-TR	Nearest
1SMA45CAT3	SMAJ43CA-TR	Nearest
1SMA48AT3	SMAJ48A-TR	Direct
1SMA48CAT3	SMAJ48CA-TR	Direct
1SMA5.0AT3	SMAJ5.0A-TR	Direct
1SMA51AT3	SMAJ48A-TR	Nearest
1SMA51CAT3	SMAJ48CA-TR	Nearest
1SMA54AT3	SMAJ58A-TR	Nearest
1SMA54CAT3	SMAJ58CA-TR	Nearest
1SMA58AT3	SMAJ58A-TR	Direct
1SMA58CAT3	SMAJ58CA-TR	Direct
1SMA6.0AT3	SMAJ6.0A-TR	Direct
1SMA6.5AT3	SMAJ6.5A-TR	Direct
1SMA60AT3	SMAJ58A-TR	Nearest
1SMA60CAT3	SMAJ58CA-TR	Nearest
1SMA64AT3	SMAJ70A-TR or SMAJ85A-TR	Nearest
1SMA64CAT3	SMAJ70CA-TR	Nearest
1SMA7.0AT3	SMAJ6.5A-TR	Nearest
1SMA7.5AT3	SMAJ6.5A-TR	Nearest
1SMA70AT3	SMAJ70A-TR or SMAJ85A-TR	Nearest
1SMA70CAT3	SMAJ70CA-TR	Direct
1SMA75AT3	SMAJ70A-TR or SMAJ85A-TR	Nearest
1SMA75CAT3	SMAJ70CA-TR	Nearest
1SMA78AT3	SMAJ85A-TR	Direct
1SMA78CAT3	SMAJ85CA-TR	Direct

Industry standard	ST part numbers	ST equivalence
1SMA8.0AT3	SM6T12A or SMAJ12A-TR	Nearest
1SMA8.5AT3	SM6T12A or SMAJ12A-TR	Nearest
1SMA9.0AT3	SM6T12A or SMAJ12A-TR	Nearest
1SMB100AT3	SMBJ130A-TR	Nearest
1SMB10AT3	SMBJ10A-TR	Direct
1SMB10CAT3	SMBJ10CA-TR	Direct
1SMB110AT3	SMBJ130A-TR	Nearest
1SMB11AT3	SMBJ10A-TR	Nearest
1SMB11CAT3	SMBJ10CA-TR	Nearest
1SMB120AT3	SMBJ130A-TR	Nearest
1SMB12AT3	SMBJ12A-TR	Direct
1SMB12CAT3	SMBJ12CA-TR	Direct
1SMB130AT3	SMBJ130A-TR	Direct
1SMB13AT3	SMBJ13A-TR	Direct
1SMB13CAT3	SMBJ13CA-TR	Direct
1SMB14AT3	SMBJ13A-TR	Nearest
1SMB14CAT3	SMBJ13CA-TR	Nearest
1SMB150AT3	SMBJ154A-TR	Direct
1SMB15AT3	SMBJ15A-TR	Direct
1SMB15CAT3	SMBJ15CA-TR	Direct
1SMB160AT3	SMBJ154A-TR	Direct
1SMB16AT3	SMBJ15A-TR	Nearest
1SMB16CAT3	SMBJ15CA-TR	Nearest
1SMB170AT3	SMBJ170A-TR	Direct
1SMB17AT3	SMBJ18A-TR	Nearest
1SMB17CAT3	SMBJ18CA-TR	Nearest
1SMB18AT3	SMBJ18A-TR	Direct
1SMB18CAT3	SMBJ18CA-TR	Direct
1SMB20AT3	SMBJ20A-TR	Direct
1SMB20CAT3	SMBJ20CA-TR	Direct
1SMB22AT3	SMBJ22A-TR	Direct
1SMB22CAT3	SMBJ24CA-TR	Nearest
1SMB24AT3	SMBJ24A-TR	Direct
1SMB24CAT3	SMBJ24CA-TR	Direct
1SMB26AT3	SMBJ26A-TR	Direct
1SMB26CAT3	SMBJ24CA-TR or SMBJ30CA-TR	Nearest
1SMB28AT3	SMBJ28A-TR	Direct
1SMB28CAT3	SMBJ28CA-TR	Direct
1SMB30AT3	SMBJ30A-TR	Direct
1SMB30CAT3	SMBJ30CA-TR	Direct
1SMB33AT3	SMBJ33A-TR	Direct
1SMB33CAT3	SMBJ33CA-TR	Direct
1SMB36AT3	SMBJ33A-TR	Nearest
1SMB36CAT3	SMBJ33CA-TR	Nearest
1SMB40AT3	SMBJ40A-TR	Direct
1SMB40CAT3	SMBJ40CA-TR	Direct
1SMB43AT3	SMBJ40A-TR	Nearest
1SMB43CAT3	SMBJ40CA-TR	Nearest
1SMB45AT3	SMBJ48A-TR	Nearest
1SMB45CAT3	SMBJ48CA-TR	Nearest

Industry standard	ST part numbers	ST equivalence
1SMB48AT3	SMBJ48A-TR	Direct
1SMB48CAT3	SMBJ48CA-TR	Direct
1SMB5.0AT3	SMBJ5.0A-TR	Direct
1SMB51AT3	SMBJ48A-TR	Nearest
1SMB51CAT3	SMBJ48CA-TR	Nearest
1SMB54AT3	SMBJ58A-TR	Nearest
1SMB54CAT3	SMBJ58CA-TR	Nearest
1SMB58AT3	SMBJ58A-TR	Direct
1SMB58CAT3	SMBJ58CA-TR	Direct
1SMB6.0AT3	SMBJ6.0A-TR	Direct
1SMB6.5AT3	SMBJ6.5A-TR	Direct
1SMB60AT3	SMBJ58A-TR	Nearest
1SMB60CAT3	SMBJ58CA-TR	Nearest
1SMB64AT3	SMBJ70A-TR	Nearest
1SMB64CAT3	SMBJ70CA-TR	Nearest
1SMB7.0AT3	SMBJ6.5A-TR	Nearest
1SMB7.5AT3	SMBJ6.5A-TR	Nearest
1SMB70AT3	SMBJ70A-TR	Direct
1SMB70CAT3	SMBJ70CA-TR	Direct
1SMB75AT3	SMBJ70A-TR	Nearest
1SMB75CAT3	SMBJ70CA-TR	Nearest
1SMB78AT3	SMBJ85A-TR	Nearest
1SMB78CAT3	SMBJ85CA-TR	Nearest
1SMB8.0AT3	SMBJ8.5A-TR	Nearest
1SMB8.5AT3	SMBJ8.5A-TR	Direct
1SMB85AT3	SMBJ85A-TR	Direct
1SMB9.0AT3	SMBJ8.5A-TR	Nearest
1SMB90AT3	SMBJ85A-TR	Nearest
1SMC10AT3	SMCJ13A-TR	Nearest
1SMC11AT3	SMCJ13A-TR	Nearest
1SMC12AT3	SMCJ13A-TR	Direct
1SMC13AT3	SMCJ13A-TR	Direct
1SMC14AT3	SMCJ13A-TR	Nearest
1SMC15AT3	SMCJ15A-TR	Direct
1SMC16AT3	SMCJ15A-TR	Nearest
1SMC17AT3	SMCJ15A-TR or SMCJ22A-TR	Nearest
1SMC18AT3	SMCJ15A-TR or SMCJ22A-TR	Nearest
1SMC20AT3	SMCJ22A-TR	Nearest
1SMC22AT3	SMCJ22A-TR	Direct
1SMC24AT3	SMCJ26A-TR	Direct
1SMC26AT3	SMCJ26A-TR	Direct
1SMC28AT3	SMCJ28A-TR	Direct
1SMC30AT3	SMCJ33A-TR	Direct
1SMC33AT3	SMCJ33A-TR	Direct
1SMC36AT3	SMCJ33A-TR	Nearest
1SMC40AT3	SMCJ40A-TR	Direct
1SMC43AT3	SMCJ40A-TR	Nearest
1SMC45AT3	SM15T68A	Nearest
1SMC48AT3	SM15T68A	Nearest
1SMC5.0AT3	SMCJ5.0A-TR	Direct
1SMC51AT3	SM15T68A	Nearest
1SMC54AT3	SM15T68A	Nearest

Cross-reference

Industry standard	ST part numbers	ST equivalence
1SMC58AT3	SM15T68A	Nearest
1SMC6.0AT3	SMCJ6.0A-TR	Direct
1SMC6.5AT3	SM15T6V8A	Direct
1SMC60AT3	SM15T68A	Nearest
1SMC64AT3	SM15T68A	Direct
1SMC7.0AT3	SM15T6V8A	Nearest
1SMC7.5AT3	SM15T6V8A	Nearest
1SMC70AT3	SM15T68A or SM15T100A	Direct
1SMC75AT3	SM15T100A	Direct
1SMC78A-TR	SM15T100A	Direct
1SMC8.0AT3	SM15T10A or SMCJ10A-TR	Nearest
1SMC8.5AT3	SM15T10A or SMCJ10A-TR	Direct
1SMC9.0AT3	SM15T10A or SMCJ10A-TR	Nearest
3A120	SMP100LC-120	Nearest
3A133	SMP100LC-200	Nearest
3A138	SMP100LC-65	Nearest
3A140	SMP100LC-120	Nearest
3A143	SMP100LC-200	Nearest
3A249	LCP1521S	Nearest
3A258	LCP1521S	Nearest
5KP100A	BZW50-100 or BZW50-150	Direct
5KP10A	BZW50-10 or BZW50-15	Direct
5KP110A	BZW50-100 or BZW50-150	Nearest
5KP11A	BZW50-10 or BZW50-15	Nearest
5KP12A	BZW50-15	Nearest
5KP13A	BZW50-15	Nearest
5KP14A	BZW50-15	Nearest
5KP15A	BZW50-15	Direct
5KP16A	BZW50-15	Nearest
5KP17A	BZW50-18	Nearest
5KP18A	BZW50-18	Direct
5KP20A	BZW50-18	Nearest
5KP22A	BZW50-22	Direct
5KP24A	BZW50-22	Nearest
5KP26A	BZW50-27	Nearest
5KP28A	BZW50-27	Nearest
5KP30A	BZW50-33	Nearest
5KP33A	BZW50-33	Direct
5KP36A	BZW50-33	Nearest
5KP40A	BZW50-39	Nearest
5KP43A	BZW50-39	Nearest
5KP45A	BZW50-39 or BZW50-56	Nearest
5KP48A	BZW50-39 or BZW50-56	Nearest
5KP51A	BZW50-39 or	Nearest

Industry standard	ST part numbers	ST equivalence
	BZW50-56	
5KP54A	BZW50-56	Nearest
5KP58A	BZW50-56	Nearest
5KP60A	BZW50-56	Nearest
5KP64A	BZW50-68	Nearest
5KP70A	BZW50-68	Nearest
5KP75A	BZW50-68	Nearest
5KP78A	BZW50-82	Nearest
5KP85A	BZW50-82	Nearest
5KP90A	BZW50-82	Nearest
6KA24	LDP24A	Direct
6KZ100	BZW50-100 or BZW50-150	Direct
6KZ100A	BZW50-100 or BZW50-150	Direct
704-190A	1.5KE200A	Nearest
704-34A	1.5KE36A	Nearest
704-45A	1.5KE47A	Nearest
704-56A	1.5KE56A	Nearest
B1100CA	LCP1521S	Nearest
B1100CB	LCP1521S	Nearest
B1101UA4	LCDP1521	Nearest
B1160CA	LCP1521S	Nearest
B1160CB	LCP1521S	Nearest
B1200CA	LCP1521S	Nearest
B1200CB	LCP1521S	Nearest
B2100CA	LCP1521S	Nearest
B2100CB	LCP1521S	Nearest
B2160CA	LCP1521S	Nearest
B2160CB	LCP1521S	Nearest
B2200CA	LCP1521S	Nearest
B2200CB	LCP1521S	Nearest
B3104UA	LCP1521S	Nearest
B3104UM	LCP02-150M	Nearest
B3164UA	LCP1521S	Nearest
B3164UM	LCP02-150M	Nearest
B3204UA	LCP1521S	Nearest
B3204UM	LCP02-150M	Nearest
BR210-140	SMP100LC-140	Nearest
BR210-200	SMP100LC-200	Nearest
BR210-220	SMP100LC-200	Nearest
BR210-240	SMP100LC-230	Nearest
BR210-260	SMP100LC-230	Nearest
BR210-280	SMP100LC-270	Nearest
BR211-100	TPA100	Direct
BR211-120	TPA120	Direct
BR211-140	TPA130	Direct
BR211-160	TPA180	Direct
BR211-180	TPA180	Direct
BR211-200	TPA200	Direct
BR211-220	TPA220	Direct
BR211-240	TPA240	Direct
BR211-260	TPA270	Direct
BR211-280	TPA270	Direct

Industry standard	ST part numbers	ST equivalence
BR220-100	SMP100LC-120	Nearest
BR220-120	SMP100LC-120	Nearest
BR220-140	SMP100LC-140	Nearest
BR220-160	SMP100LC-200	Nearest
BR220-180	SMP100LC-200	Nearest
BR220-200	SMP100LC-200	Nearest
BR220-220	SMP100LC-230	Nearest
BR220-240	SMP100LC-230	Nearest
BR220-260	TLP200G-1	Direct
BR220-280	SMP100LC-270	Nearest
BZA100	ESDA6V1S3	Direct
BZA408B	ESDA6V1-4BC6	Direct
BZD23C300	BZW06-342RL	Nearest
BZD23C360	BZW04-376	Nearest
BZG04	SMAJ series	Direct
BZT23C300	BZW06-342RL	Nearest
BZT23C360	BZW04-376	Nearest
BZW03-C10	BZW04-10	Nearest
BZW03-C100	SMAJ58A-TR	Nearest
BZW03-C12	BZW04-10	Nearest
BZW03-C120	BZW06-128RL	Nearest
BZW03-C15	BZW04-13	Nearest
BZW03-C150	P6KE150A	Nearest
BZW03-C18	BZW04-15	Nearest
BZW03-C180	P6KE150A or P6KE200A	Nearest
BZW03-C200	SMAJ170A-TR	Nearest
BZW03-C22	BZW04-15 or BZW04-26	Nearest
BZW03-C220	SMAJ188A-TR	Nearest
BZW03-C24	BZW04-20	Nearest
BZW03-C240	P6KE250ARL	Nearest
BZW03-C27	BZW04-26 or BZW04-33	Nearest
BZW03-C30	BZW04-26	Nearest
BZW03-C33	BZW04-33	Direct
BZW03-C36	BZW04-31	Nearest
BZW03-C39	BZW04-33	Nearest
BZW03-C47	BZW04-40 or BZW04-48	Nearest
BZW03-C47	BZW04-48	Direct
BZW03-C56	BZW04-48	Nearest
BZW03-C68	BZW04-48	Nearest
BZW03-C7V5	BZW04-10	Nearest
BZW03-C82	SMAJ85A-TR	Nearest
BZW03-C91	SMAJ85A-TR or SMAJ100A-TR	Nearest
BZW04-10	BZW04-10	Direct
BZW04-102	BZW06-128RL	Nearest
BZW04-102B	SM6T100CA	Nearest
BZW04-10B	BZW04-13B	Nearest
BZW04-11	BZW04-10	Nearest
BZW04-110	BZW06-128RL	Nearest
BZW04-110B	SM6T100CA	Nearest

Industry standard	ST part numbers	ST equivalence
BZW04-11B	BZW04-13B	Nearest
BZW04-128	P6KE150A	Nearest
BZW04-128B	SMAJ130CA-TR	Nearest
BZW04-13	BZW04-13	Direct
BZW04-136	P6KE150A	Nearest
BZW04-136B	SMAJ130CA-TR	Nearest
BZW04-13B	BZW04-13B	Direct
BZW04-14	BZW04-13	Nearest
BZW04-145	P6KE150A	Nearest
BZW04-145B	SMAJ170A-TR or P6KE200CA	Nearest
BZW04-14B	BZW04-13B	Nearest
BZW04-15	BZW04-15	Direct
BZW04-154	P6KE150A	Nearest
BZW04-154B	SMAJ170CA-TR	Nearest
BZW04-15B	BZW04-15B	Direct
BZW04-17	BZW04-15	Nearest
BZW04-171	SMAJ170A-TR	Nearest
BZW04-171B	SMAJ170CA-TR	Nearest
BZW04-17B	BZW04-15B	Nearest
BZW04-188	SMAJ188A-TR	Nearest
BZW04-188B	SMAJ188CA-TR	Nearest
BZW04-19	BZW04-15 or BZW04-26	Nearest
BZW04-19B	BZW04-20B	Direct
BZW04-20	BZW04-20	Direct
BZW04-20B	BZW04-20B	Direct
BZW04-213	P6KE250ARL	Nearest
BZW04-213B	P6KE250CARL	Nearest
BZW04-23	BZW04-26	Nearest
BZW04-239	P6KE250ARL	Nearest
BZW04-239B	P6KE250CARL	Nearest
BZW04-23B	BZW04-23B	Direct
BZW04-256	P6KE300A	Nearest
BZW04-256B	P6KE250CA	Nearest
BZW04-26	BZW04-26	Direct
BZW04-26B	BZW04-26B	Direct
BZW04-273	P6KE300A	Direct
BZW04-273B	BZW04-299BRL	Nearest
BZW04-28	BZW04-26 or BZW04-33	Direct
BZW04-28B	BZW04-28B	Direct
BZW04-299	BZW06-342RL	Nearest
BZW04-299B	BZW04-299BRL	Direct
BZW04-31	BZW04-31	Direct
BZW04-31B	BZW04-33B	Direct
BZW04-33	BZW04-33	Direct
BZW04-33B	BZW04-33B	Direct
BZW04-342	BZW06-342RL	Nearest
BZW04-342B	BZW04-376BRL	Nearest
BZW04-37	BZW04-33	Nearest
BZW04-376	BZW04-376	Direct
BZW04-376B	BZW04-376B	Direct
BZW04-37B	BZW04-33B	Nearest

Cross-reference

Industry standard	ST part numbers	ST equivalence
BZW04-40	BZW04-40 or BZW04-48	Direct
BZW04-40B	BZW04-48B	Nearest
BZW04-44	BZW04-40 or BZW04-48	Nearest
BZW04-44B	BZW04-48B	Nearest
BZW04-48	BZW04-48	Direct
BZW04-48B	BZW04-48B	Direct
BZW04-53	BZW04-48	Nearest
BZW04-53B	BZW04-48B	Nearest
BZW04-58	BZW04-48 or BZW04-58	Direct
BZW04-58B	BZW04-58B	Direct
BZW04-5V8	BZW04-5V8	Direct
BZW04-5V8B	BZW04-5V8B	Direct
BZW04-64	BZW04-58RL	Direct
BZW04-64B	BZW04-58B	Nearest
BZW04-6V4	BZW04-10	Nearest
BZW04-6V4B	BZW04-6V4B	Direct
BZW04-70	SMAJ85A-TR	Nearest
BZW04-70B	BZW04-70B	Direct
BZW04-78	SMAJ85A-TR	Nearest
BZW04-78B	BZW04-70B	Nearest
BZW04-7V0	BZW04-10	Nearest
BZW04-7V0B	BZW04-6V4B	Nearest
BZW04-7V8	BZW04-10	Nearest
BZW04-7V8B	BZW04-13B	Nearest
BZW04-85	SMAJ58A-TR	Nearest
BZW04-85B	SMAJ58CA-TR	Nearest
BZW04-8V5	BZW04-10	Nearest
BZW04-8V5B	BZW04-13B	Nearest
BZW04-94	SMAJ58A-TR	Nearest
BZW04-94B	SMAJ58CA-TR	Nearest
BZW04-9V4	BZW04-10	Nearest
BZW04-9V4B	BZW04-13B	Nearest
CM1213-02ST	USBLC6-2SC6	Direct
CM1213-04ST	USBLC6-2SC6	Direct
CM1215-02SO	DVIULC6-4SC6	Direct
CM1215-02ST	DVIULC6-4SC6	Direct
CP2	1.5KE series	Direct
CP3	BZW50 series	Direct
DF5A6.8LF	ESDALC6V1F1	Direct
DFP	BZW50 series	Direct
EPS12	1.5KE15A	Direct
EPS15	1.5KE18A	Direct
EPS24	1.5KE30A	Direct
EPS28	1.5KE33A	Direct
EPS33	1.5KE39A	Direct
EPS48	1.5KE56A	Direct
F1N61	P6KE series	Direct
FP1	P6KE series	Direct
FP2	1.5KE series	Direct
FP3	BZW series	Direct
FX1N61	1.5KE series	Direct

Industry standard	ST part numbers	ST equivalence
FX1N61	P6KE series	Direct
HSMCG	SMCJ or SM15T series	Nearest
HSMCJ	SMCJ or SM15T series	Direct
ICT-45	1.5KE56A	Nearest
ICT-45C	1.5KE56CARL	Nearest
ICT-5	1N5908	Nearest
ICT-8	1.5KE10A	Nearest
ICT-8C	1.5KE7V5CA	Nearest
ICTE-10	1.5KE12A	Direct
ICTE-10C	1.5KE12CA	Direct
ICTE-12	1.5KE15A	Nearest
ICTE-12C	1.5KE15CA	Nearest
ICTE-15	1.5KE18A	Direct
ICTE-15C	1.5KE18CA	Direct
ICTE-45	1.5KE56A	Direct
ICTE-45C	1.5KE56CARL	Direct
ICTE-5	1.5KE6V8A	Nearest
ICTE-8	1.5KE10A	Nearest
ICTE-8C	1.5KE7V5CA	Nearest
IP4220CZ6	DVIULC6-4SC6	Direct
KA10N14	SMP100LC-140	Nearest
KA10R25	SMP100LC-200	Nearest
KL3L07	SMP30-62	Direct
KL3N14	SMP30-130	Direct
KL3R20	SMP30-180	Direct
KP10L07	SMP100LC-65	Nearest
KP10L08	SMP100LC-65	Nearest
KP10N12	SMP100LC-140	Nearest
KP10N14	SMP100LC-140	Nearest
KP10R25	SMP100LC-200	Nearest
KP10R29	SMP100LC-270	Nearest
KP15L07	SMP100LC-65	Nearest
KP15L08	SMP100LC-65	Nearest
KP15N12	SMP100LC-140	Nearest
KP15N14	SMP100LC-140	Nearest
KP15R25	SMP100LC-200	Nearest
KP15R29	SMP100LC-270	Nearest
KP4L07	SMTPA62	Nearest
KP4L08	SMP100LC-140	Nearest
KP4L08	SMTPA68	Nearest
KP4N12	SMTPA100	Nearest
KP4N14	SMTPA120	Nearest
KP4R25	SMTPA200	Nearest
KT10L07	SMP100LC-65	Nearest
KT10L08	SMP100LC-65	Nearest
KT10N12	SMP100LC-120	Nearest
KT10N14	SMP100LC-120	Nearest
KT10R25	SMP100LC-200	Nearest
KT10R29	SMP100LC-270	Nearest
KT15N12	SMP100LC-120	Nearest
KT15N14	SMP100LC-120	Nearest
KT15R25	SMP100LC-200	Nearest

Industry standard	ST part numbers	ST equivalence
KT15R29	SMP100LC-270	Nearest
KW4R20	TSI200B1RL	Direct
L13B	1.5KE series	Nearest
L13C	1.5KE series	Nearest
L2B	P6KE series	Direct
L2C	P6KE series	Direct
L4A	P6KE series	Direct
L4B	P6KE series	Direct
L4C	P6KE series	Direct
L4D	P6KE series	Direct
L4H	P6KE series	Direct
L8B	1.5KE series	Nearest
L8C	1.5KE series	Nearest
LC	1.5KE series	Nearest
LC03-6	TPN3021	Direct
LCA05C	ESDA6V1-5W6	Nearest
LCDA03	ESDA6V1-5W6	Nearest
LCDA05	ESDA6V1-5W6	Nearest
LCDA15C-6	ESDA6V1-5W6	Nearest
LCE10A	1.5KE12A	Direct
LCE11A	1.5KE12A	Nearest
LCE12A	1.5KE15A	Direct
LCE13A	1.5KE15A	Nearest
LCE14A	1.5KE18A	Nearest
LCE15A	1.5KE18A	Direct
LCE16A	1.5KE18A	Nearest
LCE17A	1.5KE22A	Nearest
LCE18A	1.5KE22A	Direct
LCE20A	1.5KE24A	Direct
LCE22A	1.5KE24A	Nearest
LCE24A	1.5KE27A	Nearest
LCE26A	1.5KE30A	Nearest
LCE28A	1.5KE33A	Direct
LCE6.5A	1.5KE10A	Direct
LCE7.0A	1.5KE7V5A	Nearest
LCE7.5A	1.5KE7V5A	Nearest
LCE8.0A	1.5KE10A	Nearest
LCE8.5A	1.5KE10A	Direct
LCE9.0A	1.5KE10A	Nearest
MGSS150	LCP1521S	Direct
MM10TB230T3	SMP100LC-200	Nearest
MM10TB260T3	SMP100LC-230	Nearest
MM10TB310T3	SMP100LC-270	Nearest
MMB26V2ALT1	ESDA6V1L	Direct
MMQA5V6T1	ESDA6V1SC6	Direct
MPT-5	1N5908	Nearest
MPTE-45	1.5KE56A	Nearest
MPTE-45C	1.5KE56CARL	Nearest
MPTE-5	1N5908	Direct
MPTE-8	1.5KE10A	Nearest
MPTE-8C	1.5KE7V5CA	Nearest
MR2520L	BZW50-27	Direct
MR2535L	BZW50-22	Direct
MTP-45	1.5KE56A	Nearest

Industry standard	ST part numbers	ST equivalence
MTP-45C	1.5KE56CARL	Nearest
MTP-8	1.5KE10A	Nearest
MTP-8C	1.5KE7V5CA	Nearest
NUP2201MR6	USBLC6-2SC6	Direct
NUP4201MR6	USBLC6-4SC6	Direct
NZQA6V8AXV5	ESDALC6V1P6	Direct
P0080EC	SMP100LC-8	Nearest
P0080SA	SMP75-8	Nearest
P0080SA MC	SMP75-8	Nearest
P0080SB	SMP75-8	Nearest
P0080SB MC	SMP75-8	Nearest
P0080SC	SMP100LC-8	Direct
P0080SC MC	SMP100LC-8	Nearest
P0300EC	SMP100LC-25	Nearest
P0300SC	SMP100LC-25	Direct
P0300SC MC	SMP100LC-25	Nearest
P0640EA	TPA or SMP30-68	Nearest
P0640EB	TPA68	Nearest
P0640EC	SMP100LC-65	Nearest
P0640EC MC	SMP100LC-65	Nearest
P0640SA	SMP30- or SMTPA62	Direct
P0640SA MC	SMP30- or SMTPA62	Direct
P0640SB	SMP50-68 or SMTPA65	Direct
P0640SB MC	SMP50-62 or SMTPA62	Nearest
P0640SC	SMP100LC-65	Direct
P0640SC MC	SMP100LC-65	Nearest
P0641SA	LCP1521S	Nearest
P0720EA	TPA or SMP30-68	Nearest
P0720EB	TPA68	Nearest
P0720EC	SMP100LC-65	Nearest
P0720SA	SMP30- or SMTPA68	Direct
P0720SA MC	SMP30- or SMTPA68	Direct
P0720SB	SMP50-68 or SMTPA65	Direct
P0720SB MC	SMP50-68 or SMTPA68	Nearest
P0720SC	SMP100LC-65	Direct
P0720SC MC	SMP100LC-65	Nearest
P0721SA	LCP1521S	Nearest
P0800EA	TPA or SMP30-68	Nearest
P0800EB	TPA68	Nearest
P0800EC	SMP100LC-65	Nearest
P0800SA	SMP30- or SMTPA68	Direct

Cross-reference

Industry standard	ST part numbers	ST equivalence
P0800SA MC	SMP30- or SMTPA68	Direct
P0800SB	SMP50-68 or SMTPA68	Nearest
P0800SB MC	SMP50-68 or SMTPA68	Nearest
P0800SC	SMP100LC-65	Nearest
P0800SC MC	SMP100LC-65	Nearest
P0900EA	TPA100	Nearest
P0900EB	TPA100	Nearest
P0900EC	SMP100LC-90	Nearest
P0900SA	SMP30- or SMTPA100	Direct
P0900SA MC	SMP30- or SMTPA100	Direct
P0900SB	SMP50- or SMTPA100	Nearest
P0900SB MC	SMP50- or SMTPA100	Nearest
P0900SC	SMP100LC-90	Nearest
P0900SC MC	SMP100LC-90	Nearest
P1.5KE	1.5KE series	Nearest
P1001SC	LCP1521S	Nearest
P1100EA	TPA or SMP30-100	Nearest
P1100EB	TPA100 or SMP80MC-90	Nearest
P1100EC	SMP100LC-100	Nearest
P1100SA	SMP30- or SMTPA100	Direct
P1100SA MC	SMP30- or SMTPA100	Direct
P1100SB	SMP80MC-120 or SMP50-100 or SMTPA100	Nearest
P1100SB MC	SMP80MC-120 or SMP50-100 or SMTPA100	Direct
P1100SC	SMP100LC-100	Direct
P1100SC MC	SMP100MC-120	Nearest
P1300EA	TPA or SMP30-120	Nearest
P1300EB	TPA130 or SMP80MC-120	Nearest
P1300EC	SMP100LC-120	Nearest
P1300SA	SMP30- or SMTPA120	Direct
P1300SA MC	SMP30- or SMTPA120	Direct
P1300SB	SMP80MC-120 or SMP50- or SMTPA130	Direct
P1300SB MC	SMP80MC-120 or SMP50- or	Direct

Industry standard	ST part numbers	ST equivalence
	SMTPA130	
P1300SC	SMP100LC-120	Direct
P1300SC MC	SMP100MC-120	Direct
P1402AA	TLP140G-1	Nearest
P1402AB	TLP140G-1	Nearest
P1402AC	TLP140G-1	Nearest
P1500EA	TPA130 or SMP30-140	Nearest
P1500EB	TPA130 or SMP80MC-140	Nearest
P1500EC	SMP100LC-140	Nearest
P1500EC MC	SMP100MC-140	Nearest
P1500SA	SMP30- or SMTPA130	Direct
P1500SA MC	SMP30- or SMTPA130	Direct
P1500SB	SMP80MC-120 or SMP50- or SMTPA130	Nearest
P1500SB MC	SMP80MC-120 or SMP50- or SMTPA130	Direct
P1500SC	SMP100LC-140	Direct
P1500SC MC	SMP100MC-140	Direct
P1553AA	TLP140G-1	Nearest
P1553AB	TLP140G-1	Direct
P1553AC	TLP140G-1	Direct
P1602AA	TLP140G-1	Nearest
P1602AB	TLP140G-1	Nearest
P1602AC	TLP140G-1	Nearest
P1800EA	TPA or SMP30-180	Nearest
P1800EB	TPA130 or SMP80MC-160	Nearest
P1800EC	SMP100LC-160	Nearest
P1800SA	SMP30- or SMTPA160	Direct
P1800SA MC	SMP30- or SMTPA160	Direct
P1800SB	SMP80MC-160 or SMP50- or SMTPA160	Nearest
P1800SB MC	SMP80MC-160 or SMP50- or SMTPA160	Direct
P1800SC	SMP100LC-160	Direct
P1800SC MC	SMP100MC-160	Direct
P1803AA	TLP140G-1	Nearest
P1803AB	TLP140G-1	Nearest
P1803AC	TLP140G-1	Nearest
P2103AA	TLP140G-1	Nearest
P2103AB	TLP140G-1	Nearest
P2103AC	TLP140G-1	Nearest
P2202AA	TLP200G-1	Nearest

Industry standard	ST part numbers	ST equivalence
P2202AB	TLP200G-1	Direct
P2202AC	TLP200G-1	Direct
P2300EA	TPA or SMP30-200	Nearest
P2300EB	TPA or SMP80MC-200	Nearest
P2300EC	SMP100LC-200	Nearest
P2300SA	SMP30- or SMTPA200	Direct
P2300SA MC	SMP30- or SMTPA200	Direct
P2300SB	SMP80MC- or SMP50- or SMTPA200	Nearest
P2300SB MC	SMP80MC- or SMP50- or SMTPA200	Direct
P2300SC	SMP100LC-200	Direct
P2300SC MC	SMP100MC-200	Direct
P2353AA	TLP200G-1	Nearest
P2353AB	TLP200G-1	Nearest
P2353AC	TLP200G-1	Nearest
P2600EA	TPA or SMP30-230	Nearest
P2600EB	TPA or SMP80MC-230	Nearest
P2600EC	SMP100LC-230	Nearest
P2600EC MC	SMP100MC-230	Nearest
P2600SA	SMP30- or SMTPA230	Direct
P2600SA MC	SMP30- or SMTPA230	Direct
P2600SB	SMP80MC-230 or SMP50-240 or SMTPA240	Nearest
P2600SB MC	SMP80MC-230 or SMP50-240 or SMTPA240	Direct
P2600SC	SMP100LC-230	Direct
P2600SC MC	SMP100MC-230	Direct
P2702AA	TLP270G-1	Nearest
P2702AB	TLP270G-1	Nearest
P2702AC	TLP270G-1	Nearest
P2703AA	TLP270G-1	Nearest
P2703AB	TLP270G-1	Nearest
P2703AC	TLP270G-1	Nearest
P3002AA	TLP270G-1	Nearest
P3002AB	TLP270G-1	Nearest
P3002AC	TLP270G-1	Nearest
P3100EA	TPA or SMP30-270	Nearest
P3100EB	TPA or SMP80MC-270	Nearest
P3100EC	SMP100LC-270	Nearest

Industry standard	ST part numbers	ST equivalence
P3100EC MC	SMP100MC-270	Nearest
P3100SA	SMP30- or SMTPA270	Direct
P3100SA MC	SMP30- or SMTPA270	Direct
P3100SB	SMP80MC- or SMP50- or SMTPA270	Nearest
P3100SB MC	SMP80MC- or SMP50 or SMTPA270	Direct
P3100SC	SMP100LC-270	Direct
P3100SC MC	SMP100MC-270	Direct
P3203AA	TLP270G-1	Nearest
P3203AB	TLP270G-1	Nearest
P3203AC	TLP270G-1	Nearest
P3500EA	TPA or SMP30-270	Nearest
P3500EB	TPA or SMP80MC-270	Nearest
P3500EC	SMP100LC-320	Nearest
P3500SA	SMP30- or SMTPA270	Nearest
P3500SB	SMP80MC- or - SMP50 or SMTPA270	Nearest
P3500SC	SMP100LC-320	Nearest
P4KA10A	BZW04-10	Direct
P4KA11A	BZW04-10	Direct
P4KA12A	BZW04-10	Nearest
P4KA13A	BZW04-13	Direct
P4KA15A	BZW04-13	Nearest
P4KA16A	BZW04-15	Direct
P4KA18A	BZW04-15	Nearest
P4KA20A	BZW04-15 or BZW04-26	Nearest
P4KA22A	BZW04-20	Direct
P4KA24A	BZW04-26	Direct
P4KA27A	BZW04-26	Direct
P4KA30A	BZW04-26 or BZW04-33	Direct
P4KA33A	BZW04-31	Direct
P4KA36A	BZW04-33	Nearest
P4KA39A	BZW04-40 or BZW04-48	Nearest
P4KA43A	BZW04-40 or BZW04-48	Direct
P4KA6.8A	BZW04-5V8	Direct
P4KA7.5A	BZW04-10	Nearest
P4KA8.2A	BZW04-10	Nearest
P4KA9.1A	BZW04-10	Nearest
P4KE100A	SMAJ58A-TR	Nearest
P4KE100CA	SMAJ58CA-TR	Nearest
P4KE10A	BZW04-10	Direct

Cross-reference

Industry standard	ST part numbers	ST equivalence
P4KE10CA	BZW04-13B	Nearest
P4KE110A	SMAJ58A-TR	Nearest
P4KE110CA	SMAJ58CA-TR	Nearest
P4KE11A	BZW04-10	Nearest
P4KE11CA	BZW04-13B	Nearest
P4KE120A	BZW06-128RL	Nearest
P4KE120CA	SMAJ130CA-TR	Nearest
P4KE12A	BZW04-10	Direct
P4KE12CA	BZW04-13B	Nearest
P4KE130A	BZW06-128RL	Nearest
P4KE130CA	SMAJ130CA-TR	Nearest
P4KE13A	BZW04-10	Nearest
P4KE13CA	BZW04-13B	Direct
P4KE150A	P6KE150A	Nearest
P4KE150CA	SMAJ130CA-TR	Nearest
P4KE15A	BZW04-13	Direct
P4KE15CA	BZW04-13B	Direct
P4KE160A	P6KE150A or P6KE200A	Nearest
P4KE160CA	SMAJ130CA-TR	Nearest
P4KE16A	BZW04-13	Nearest
P4KE16CA	BZW04-13B	Nearest
P4KE170A	P6KE150A or P6KE200A	Nearest
P4KE170CA	BZW04-154B	Nearest
P4KE180A	P6KE150A or P6KE200A	Nearest
P4KE180CA	BZW04-154B	Direct
P4KE18A	BZW04-15	Direct
P4KE18CA	BZW04-15B	Direct
P4KE200A	SMAJ170A-TR	Nearest
P4KE200CA	SMAJ170CA-TR	Nearest
P4KE20A	BZW04-15 or BZW04-26	Nearest
P4KE20CA	BZW04-20B	Direct
P4KE220A	SMAJ188A-TR	Nearest
P4KE220CA	SMAJ188CA-TR	Nearest
P4KE22A	BZW04-15 or BZW04-26	Nearest
P4KE22CA	BZW04-23B	Direct
P4KE24A	BZW04-20	Direct
P4KE24CA	BZW04-20B	Direct
P4KE250A	P6KE250ARL	Nearest
P4KE250CA	P6KE250CARL	Nearest
P4KE27A	BZW04-26	Direct
P4KE27CA	BZW04-23B	Direct
P4KE300A	P6KE300A	Nearest
P4KE300CA	BZW04-256B	Direct
P4KE30A	BZW04-26	Direct
P4KE30CA	BZW04-26B	Direct
P4KE33A	BZW04-33	Direct
P4KE33CA	BZW04-28B	Direct
P4KE350A	BZW06-342RL	Nearest
P4KE350CA	BZW04-299B	Direct

Industry standard	ST part numbers	ST equivalence
P4KE36A	BZW04-31	Direct
P4KE36CA	BZW04-31B	Direct
P4KE39A	BZW04-33	Direct
P4KE39CA	BZW04-33B	Direct
P4KE400A	BZW06-342RL	Nearest
P4KE400CA	P6KE400CA	Nearest
P4KE43A	BZW04-33	Nearest
P4KE43CA	BZW04-33B	Nearest
P4KE440A	BZW04-376	Direct
P4KE440CA	BZW04-376B	Direct
P4KE47A	BZW04-40 or BZW04-48	Direct
P4KE47CA	BZW04-48B	Nearest
P4KE51A	BZW04-40 or BZW04-48	Nearest
P4KE51CA	BZW04-48B	Nearest
P4KE56A	BZW04-48	Direct
P4KE56CA	BZW04-48B	Direct
P4KE6.8A	BZW04-5V8	Direct
P4KE6.8CA	BZW04-5V8B	Direct
P4KE62A	BZW04-48	Nearest
P4KE62CA	BZW04-48B	Nearest
P4KE68A	BZW04-58	Direct
P4KE68CA	BZW04-58B	Direct
P4KE7.5A	BZW04-10	Nearest
P4KE7.5CA	BZW04-6V4B	Direct
P4KE75A	BZW04-58	Nearest
P4KE75CA	BZW04-58B	Nearest
P4KE8.2A	BZW04-10	Nearest
P4KE8.2CA	BZW04-13B	Nearest
P4KE82A	SMAJ85A-TR	Nearest
P4KE82CA	BZW04-70B	Direct
P4KE9.1A	BZW04-10	Nearest
P4KE9.1CA	BZW04-13B	Nearest
P4KE91A	SMAJ85A-TR or SMAJ100A-TR	Nearest
P4KE91CA	BZW04-70B	Nearest
P4SMA16AT3	SMAJ13A-TR	Direct
P-5KE	P6KE series	Direct
P5KE10	P6KE12ARL	Nearest
P5KE100	SMBJ130A-TR	Nearest
P5KE100A	SMBJ130A-TR	Nearest
P5KE100C	SM6T150CA	Nearest
P5KE100CA	SM6T150CA	Nearest
P5KE10A	P6KE12ARL	Nearest
P5KE10C	P6KE12CA	Direct
P5KE10CA	P6KE12CA	Direct
P5KE12	P6KE15A	Direct
P5KE120	P6KE150A	Direct
P5KE120A	P6KE150A	Direct
P5KE120C	P6KE150CA	Direct
P5KE120CA	P6KE150CA	Direct
P5KE12A	P6KE15A	Direct
P5KE12C	P6KE12CA	Direct

Industry standard	ST part numbers	ST equivalence
P5KE12CA	P6KE12CA	Direct
P5KE13	P6KE15A	Direct
P5KE130	P6KE150A	Direct
P5KE130A	P6KE150A	Direct
P5KE130C	P6KE150CA	Direct
P5KE130CA	P6KE150CA	Direct
P5KE13A	P6KE15A	Direct
P5KE13C	P6KE12CA or P6KE15CA	Nearest
P5KE13CA	P6KE12CA or P6KE15CA	Nearest
P5KE15	P6KE18A	Direct
P5KE150	P6KE180A	Direct
P5KE150A	P6KE180A	Direct
P5KE150C	P6KE150CA	Direct
P5KE150CA	P6KE150CA	Direct
P5KE15A	P6KE18A	Direct
P5KE15C	P6KE18CA	Direct
P5KE15CA	P6KE18CA	Direct
P5KE16	P6KE18A	Direct
P5KE160	P6KE180A	Direct
P5KE160A	P6KE180A	Direct
P5KE160C	P6KE150CA or P6KE200CA	Direct
P5KE160CA	P6KE150CA or P6KE200CA	Direct
P5KE16A	P6KE18A	Direct
P5KE16C	P6KE18CA	Direct
P5KE16CA	P6KE18CA	Direct
P5KE170	P6KE200A	Direct
P5KE170A	P6KE200A	Direct
P5KE170C	P6KE200CA	Direct
P5KE170CA	P6KE200CA	Direct
P5KE18	P6KE18A	Direct
P5KE18A	P6KE18A	Direct
P5KE18C	P6KE18CA	Direct
P5KE18CA	P6KE18CA	Direct
P5KE22	P6KE27A	Direct
P5KE22A	P6KE27A	Direct
P5KE22C	P6KE27CA	Direct
P5KE22CA	P6KE27CA	Direct
P5KE24	P6KE27A	Direct
P5KE24A	P6KE27A	Direct
P5KE24C	P6KE27CA	Direct
P5KE24CA	P6KE27CA	Direct
P5KE26	P6KE30A	Direct
P5KE26A	P6KE30A	Direct
P5KE26C	P6KE30CA	Direct
P5KE26CA	P6KE30CA	Direct
P5KE28	P6KE33A	Direct
P5KE28A	P6KE33A	Direct
P5KE28C	P6KE33CA	Direct
P5KE28CA	P6KE33CA	Direct
P5KE30	P6KE36A	Direct

Industry standard	ST part numbers	ST equivalence
P5KE30A	P6KE36A	Direct
P5KE30CA	P6KE36CA	Direct
P5KE33	P6KE39A	Direct
P5KE33A	P6KE39A	Direct
P5KE33C	P6KE39CA	Direct
P5KE33CA	P6KE39CA	Direct
P5KE40	P6KE39A	Nearest
P5KE40A	P6KE39A	Nearest
P5KE40C	P6KE47CA	Direct
P5KE40CA	P6KE47CA	Direct
P5KE48	P6KE39A or P6KE68A	Nearest
P5KE48A	P6KE39A or P6KE68A	Nearest
P5KE48C	P6KE47CA	Nearest
P5KE48CA	P6KE47CA	Nearest
P5KE5.0	P6KE6V8A	Direct
P5KE5.0A	P6KE6V8A	Direct
P5KE5.0C	P6KE6V8CA	Direct
P5KE5.0CA	P6KE6V8CA	Direct
P5KE58	P6KE68A	Direct
P5KE58A	P6KE68A	Direct t
P5KE58C	SMBJ58CA-TR	Nearest
P5KE58CA	SMBJ58CA-TR	Nearest
P5KE6.0	P6KE6V8A	Direct
P5KE6.0A	P6KE6V8A	Direct
P5KE6.0C	P6KE6V8CA	Direct
P5KE6.0CA	P6KE6V8CA	Direct
P5KE6.5	P6KE6V8A	Direct
P5KE6.5A	P6KE6V8A	Direct
P5KE6.5C	P6KE7V5CA	Direct
P5KE6.5CA	P6KE7V5CA	Direct
P5KE60	P6KE68A	Direct
P5KE60A	P6KE68A	Direct
P5KE60C	SMBJ58CA-TR or SMBJ70CA-TR	Nearest
P5KE60CA	SMBJ58CA-TR or SMBJ70CA-TR	Nearest
P5KE70	P6KE68A	Direct
P5KE70A	P6KE68A	Direct
P5KE70C	P6KE82CA	Direct
P5KE70CA	P6KE68CARL or P6KE82CA	Nearest
P5KE8.5	P6KE12ARL	Nearest
P5KE8.5A	P6KE12ARL	Nearest
P5KE8.5C	SMAJ8.5CA-TR or P6KE12CA	Nearest
P5KE8.5CA	SMAJ8.5CA-TR or P6KE12CA	Nearest
P5KE85	P6KE150A	Nearest
P5KE85A	P6KE150A	Nearest
P5KE85C	SMBJ85CA-TR or P6KE150CA	Nearest

Cross-reference

Industry standard	ST part numbers	ST equivalence
P5KE85CA	SMBJ85CA-TR or P6KE150CA	Nearest
P6KA10A	P6KE12ARL	Direct
P6KA11A	P6KE12ARL	Nearest
P6KA12A	P6KE12ARL	Direct
P6KA13A	P6KE15A	Nearest
P6KA15A	P6KE15A	Direct
P6KA16A	P6KE18A	Nearest
P6KA18A	P6KE18A	Direct
P6KA20A	P6KE18A or P6KE24A	Nearest
P6KA22A	P6KE18A or P6KE24A	Nearest
P6KA24A	P6KE24A	Direct
P6KA27A	P6KE27A	Direct
P6KA30A	P6KE30A	Direct
P6KA33A	P6KE33A	Direct
P6KA36A	P6KE36A	Direct
P6KA39A	P6KE39A	Direct
P6KA43A	P6KE39A or P6KE68A	Nearest
P6KA6.8A	P6KE6V8A	Direct
P6KA7.5A	P6KE6V8A	Direct
P6KA8.2A	P6KE6V8A	Nearest
P6KA9.1A	P6KE12ARL	Nearest
P6KE100A	P6KE150A	Nearest
P6KE100CA	SMBJ100CA-TR or P6KE150CA	Nearest
P6KE10A	P6KE15A	Nearest
P6KE10CA	P6KE12CA	Nearest
P6KE110A	P6KE150A	Nearest
P6KE110CA	SMBJ100CA-TR or P6KE150CA	Nearest
P6KE11A	P6KE15A	Nearest
P6KE11CA	P6KE12CA	Nearest
P6KE120A	SMBJ130A-TR	Nearest
P6KE120CA	SM6T150CA	Nearest
P6KE12A	P6KE12ARL	Nearest
P6KE12CA	P6KE12CA	Direct
P6KE130A	SMBJ130A-TR	Nearest
P6KE130CA	SM6T150CA	Nearest
P6KE13A	P6KE12ARL	Nearest
P6KE13CA	P6KE12CA	Nearest
P6KE150A	P6KE150A	Direct
P6KE150CA	P6KE150CA	Direct
P6KE15A	P6KE15A	Direct
P6KE15CA	P6KE18CARL	Nearest
P6KE160A	P6KE150A	Nearest
P6KE160CA	P6KE150CA	Nearest
P6KE16A	P6KE15A	Nearest
P6KE16CA	P6KE18CARL	Nearest
P6KE170A	P6KE180A	Nearest
P6KE170CA	P6KE150CA or	Nearest

Industry standard	ST part numbers	ST equivalence
	P6KE200CA	
P6KE180A	P6KE180A	Direct
P6KE180CA	P6KE150CA or P6KE200CA	Direct
P6KE18A	P6KE18A	Direct
P6KE18CA	P6KE18CA	Direct
P6KE200A	P6KE200A	Direct
P6KE200CA	P6KE200CA	Direct
P6KE20A	P6KE18A	Nearest
P6KE20CA	P6KE18CA	Nearest
P6KE220A	P6KE250ARL	Nearest
P6KE220CA	P6KE250CA	Nearest
P6KE22A	P6KE18A or P6KE24A	Nearest
P6KE22CA	P6KE27CA	Nearest
P6KE24A	P6KE24A	Direct
P6KE24CA	P6KE27CA	Nearest
P6KE250A	P6KE250ARL	Direct
P6KE250CA	P6KE250CA	Direct
P6KE27A	P6KE27A	Direct
P6KE27CA	P6KE27CA	Direct
P6KE300A	P6KE300A	Direct
P6KE300CA	P6KE400CA	Nearest
P6KE30A	P6KE30A	Direct
P6KE30CA	P6KE30CA	Direct
P6KE33A	P6KE33A	Direct
P6KE33CA	P6KE33CA	Direct
P6KE350A	P6KE300A or P6KE400A	Direct
P6KE350CA	P6KE400CA	Nearest
P6KE36A	P6KE36A	Direct
P6KE36CA	P6KE36CA	Direct
P6KE39A	P6KE39A	Direct
P6KE39CA	P6KE39CA	Direct
P6KE400A	P6KE400A	Direct
P6KE400CA	P6KE400CA	Direct
P6KE43A	P6KE39A	Nearest
P6KE43CA	P6KE39CA	Nearest
P6KE440A	P6KE440A	Direct
P6KE440CA	P6KE440CA	Direct
P6KE47A	P6KE39A or P6KE68A	Nearest
P6KE47CA	P6KE47CA	Direct
P6KE51A	P6KE39A or P6KE68A	Nearest
P6KE51CA	P6KE47CA	Nearest
P6KE56A	P6KE39A or P6KE68A	Nearest
P6KE56CA	SMBJ58CA-TR	Nearest
P6KE62A	P6KE39A or P6KE68A	Nearest
P6KE62CA	SMBJ70CA-TR	Nearest
P6KE68A	P6KE68A	Direct
P6KE68CA	SMBJ58CA-TR or	Nearest

Industry standard	ST part numbers	ST equivalence
	SMBJ70CA-TR	
P6KE6V8A	P6KE6V8A	Direct
P6KE6V8CA	P6KE6V8CA	Direct
P6KE7.5A	P6KE15A	Nearest
P6KE7.5CA	P6KE7V5CA	Direct
P6KE75A	P6KE68A	Nearest
P6KE75CA	SMBJ70CA-TR or SMBJ85CA-TR	Nearest
P6KE8.2A	P6KE15A	Nearest
P6KE8.2CA	P6KE7V5CA	Nearest
P6KE82A	P6KE68A to P6KE150A	Direct
P6KE82CA	SMBJ70CA-TR	Nearest
P6KE9.1A	P6KE15A	Nearest
P6KE9.1CA	P6KE12CA	Nearest
P6KE91A	P6KE68A to P6KE150A	Nearest
P6KE91CA	SM6T100CA	Nearest
P6SE	P6KE series	Direct
P6SMB100AT3	SM6T100A	Direct
P6SMB10AT3	SM6T10A	Direct
P6SMB110AT3	SM6T100A	Nearest
P6SMB11AT3	SM6T10A	Nearest
P6SMB11CAT3	SM6T10CA	Nearest
P6SMB120AT3	SM6T100A	Nearest
P6SMB12AT3	SM6T12A	Direct
P6SMB12CAT3	SM6T12CA	Direct
P6SMB130AT3	SM6T150A	Nearest
P6SMB13AT3	SM6T12A	Nearest
P6SMB13CAT3	SM6T12CA	Nearest
P6SMB150AT3	SM6T150A	Direct
P6SMB15AT3	SM6T15A	Direct
P6SMB15CAT3	SM6T15CA	Direct
P6SMB160AT3	SM6T150A	Nearest
P6SMB16AT3	SM6T15A	Nearest
P6SMB16CAT3	SM6T15CA	Nearest
P6SMB180AT3	SMBJ154A-TR	Direct
P6SMB18AT3	SM6T18A	Direct
P6SMB18CAT3	SM6T18CA	Direct
P6SMB200AT3	SM6T200A	Direct
P6SMB20AT3	SM6T18A	Nearest
P6SMB20CAT3	SM6T18CA	Nearest
P6SMB22AT3	SM6T22A	Direct
P6SMB22CAT3	SM6T22CA	Direct
P6SMB24AT3	SM6T24A	Direct
P6SMB24CAT3	SM6T24CA	Direct
P6SMB27AT3	SM6T27A	Direct
P6SMB27CAT3	SM6T27CA	Direct
P6SMB30AT3	SM6T30A	Direct
P6SMB30CAT3	SM6T30CA	Direct
P6SMB33AT3	SM6T33A	Direct
P6SMB33CAT3	SM6T33CA	Direct
P6SMB36AT3	SM6T36A	Direct
P6SMB36CAT3	SM6T36CA	Direct

Industry standard	ST part numbers	ST equivalence
P6SMB39AT3	SM6T39A	Direct
P6SMB39CAT3	SM6T39CA	Direct
P6SMB43AT3	SMBJ40A-TR	Nearest
P6SMB43CAT3	SMBJ40CA-TR	Nearest
P6SMB47AT3	SMBJ40A-TR	Direct
P6SMB47CAT3	SMBJ40CA-TR	Direct
P6SMB51AT3	SMBJ40A-TR	Nearest
P6SMB51CAT3	SMBJ40CA-TR	Nearest
P6SMB56AT3	SMBJ48A-TR	Direct
P6SMB56CAT3	SMBJ48CA-TR	Direct
P6SMB6.8AT3	SM6T6V8A	Direct
P6SMB62AT3	SMBJ48A-TR	Nearest
P6SMB62CAT3	SMBJ48CA-TR	Nearest
P6SMB68AT3	SM6T68A	Direct
P6SMB68CAT3	SM6T68CA	Direct
P6SMB7.5AT3	SM6T7V5A	Direct
P6SMB75AT3	SM6T68A	Nearest
P6SMB75CAT3	SM6T68CA	Nearest
P6SMB8.2AT3	SM6T7V5A	Nearest
P6SMB82AT3	SMBJ70A-TR	Direct
P6SMB82CAT3	SMBJ70CA-TR	Direct
P6SMB9.1AT3	SM6T10A	Nearest
P6SMB91AT3	SMBJ70A-TR	Nearest
P6SMB91CAT3	SMBJ70CA-TR	Nearest
P7KE10	P6KE12ARL	Nearest
P7KE100	SMBJ130A-TR	Nearest
P7KE100C	SM6T150CA	Nearest
P7KE10C	P6KE12CA	Nearest
P7KE25	P6KE30A	Nearest
P7KE25C	P6KE30CA	Nearest
P7KE43	P6KE39A	Nearest
P7KE43C	P6KE47CA	Nearest
PAC DN004	DALC208SC6	Nearest
PAC DN006M	DALC112S1	Nearest
PAC DN006S	DALC112S1	Nearest
PAC VGA-100	VGAF01	Direct
PESDxL2UM	ESDALC6V1M3	Direct
PLCDA05	ESDA6V1-5W6	Nearest
PSMDA05C-4	ITA6V5B1	Direct
PSMDA15C-4	ITA18B1	Direct
PSMDA24C-4	ITA25B1	Direct
R5KP	BZW50 series	Nearest
SA100A	P6KE150A	Nearest
SA100A	P6KE12ARL	Direct
SA100C	P6KE150CA	Direct
SA100CA	P6KE150CA	Direct
SA10A	BZW06-10	Direct
SA10C	BZW06-10B	Direct
SA10CA	BZW06-10B	Direct
SA110A	P6KE150A	Nearest
SA110CA	P6KE150CA	Nearest
SA11A	BZW06-10	Nearest
SA11CA	BZW06-10B	Nearest
SA120A	P6KE150A	Nearest

Cross-reference

Industry standard	ST part numbers	ST equivalence
SA120C	P6KE150CA	Nearest
SA120CA	P6KE150CA	Nearest
SA12A	BZW06-15	Nearest
SA12CA	BZW06-13B	Nearest
SA130A	P6KE150A	Nearest
SA130CA	P6KE150CA	Nearest
SA13A	BZW06-15	Nearest
SA13C	BZW06-13B	Direct
SA13CA	BZW06-13B	Direct
SA14A	BZW06-15	Nearest
SA14CA	BZW06-13B	Nearest
SA150A	SM6T150A	Nearest
SA150C	P6KE150CA	Nearest
SA150CA	P6KE150CA	Nearest
SA15A	BZW06-15	Direct
SA15C	BZW06-15B	Direct
SA15CA	BZW06-15B	Direct
SA160A	SM6T150A	Nearest
SA160CA	P6KE150CA	Nearest
SA16A	BZW06-15 or BZW06-23	Nearest
SA16CA	BZW06-15B or BZW06-23B	Nearest
SA170A	BZW06-188RL or SMBJ170A-TR	Nearest
SA170C	BZW06-188RL or SMBJ170A-TR	Nearest
SA170CA	BZW06-171B	Direct
SA170CA	P6KE200CA	Direct
SA17A	BZW06-15 or BZW06-23	Nearest
SA17CA	BZW06-15B or BZW06-23B	Direct
SA18A	BZW06-15 or BZW06-23	Nearest
SA18CA	BZW06-15B or BZW06-23B	Nearest
SA20A	BZW06-19RL or BZW06-23RL	Nearest
SA20C	BZW06-19BRL or BZW06-23BRL	Nearest
SA20CA	BZW06-19BRL or BZW06-23BRL	Nearest
SA22A	BZW06-23	Nearest
SA22C	BZW06-23B	Direct
SA22CA	BZW06-23B	Nearest
SA24A	BZW06-23	Nearest
SA24CA	BZW06-23B	Nearest
SA26A	BZW06-26	Direct
SA26C	BZW06-26B	Direct
SA26CA	BZW06-26B	Direct
SA28A	BZW06-28	Direct
SA28C	BZW06-28B	Direct
SA28CA	BZW06-28B	Direct

Industry standard	ST part numbers	ST equivalence
SA30A	BZW06-31	Nearest
SA30C	BZW06-31B	Direct
SA30CA	BZW06-31B	Nearest
SA33A	BZW06-33	Direct
SA33C	BZW06-33B	Direct
SA33CA	BZW06-33B	Direct
SA36A	BZW06-40RL	Nearest
SA36CA	BZW06-37B	Nearest
SA40A	BZW06-40RL	Direct
SA40C	BZW06-48B	Nearest
SA40CA	BZW06-48B	Nearest
SA43A	SMBJ40A-TR	Nearest
SA43CA	BZW06-48B	Nearest
SA45A	SMBJ40A-TR	Nearest
SA45CA	BZW06-48B	Nearest
SA48A	BZW06-40RL or SMBJ48A-TR	Nearest
SA48C	BZW06-48B	Direct
SA48CA	BZW06-48B	Direct
SA5.0A	BZW06-5V8	Direct
SA5.0CA	BZW06-5V8B	Direct
SA51A	SMBJ48A-TR or SM6T68A	Nearest
SA51CA	BZW06-48BRL	Nearest
SA54A	SMBJ48A-TR or SM6T68A	Nearest
SA54CA	BZW06-58BRL	Nearest
SA58A	P6KE68A or SMAJ58A-TR	Nearest
SA58C	BZW06-58B	Direct
SA58CA	BZW06-58B	Direct
SA6.0A	BZW06-6V4	Nearest
SA6.0C	BZW06-5V8B	Direct
SA6.0CA	BZW06-6V4B	Nearest
SA6.5A	BZW06-6V4	Direct
SA6.5C	BZW06-6V4B	Direct
SA6.5CA	BZW06-6V4B	Direct
SA60A	P6KE68A or SMAJ58A-TR	Nearest
SA60CA	BZW06-58B	Nearest
SA64A	SMBJ48A-TR or SM6T68A	Nearest
SA64CA	SMBJ70CA-TR	Nearest
SA7.0A	BZW06-6V4	Nearest
SA7.0CA	BZW06-6V4B	Nearest
SA7.5A	BZW06-10	Nearest
SA7.5CA	BZW06-10B	Nearest
SA70A	SM6T68A or SMBJ70A-TR	Nearest
SA70C	SMBJ70CA-TR	Nearest
SA70CA	SMBJ70CA-TR	Nearest
SA75A	SMBJ70A-TR	Nearest
SA75CA	SMBJ70CA-TR	Nearest
SA78A	SMBJ85A-TR	Nearest

Industry standard	ST part numbers	ST equivalence
SA78C	SMBJ85CA-TR	Direct
SA78CA	BZW06-85B	Nearest
SA8.0A	BZW06-10	Nearest
SA8.0CA	BZW06-10B	Nearest
SA8.5A	BZW06-10	Nearest
SA8.5CA	BZW06-10B	Nearest
SA85A	SMBJ85A-TR	Direct
SA85C	BZW06-85B	Direct
SA85CA	BZW06-85B	Direct
SA9.0A	BZW06-10	Nearest
SA9.0CA	BZW06-10B	Nearest
SA90A	SMBJ85A-TR	Nearest
SA90CA	BZW06-85B	Nearest
SAB10	BZW06-10	Direct
SAB15	BZW06-15	Direct
SAB28	BZW06-28	Direct
SAC10	BZW06-10	Nearest
SAC12	BZW06-15	Nearest
SAC15	BZW06-15	Nearest
SAC18	BZW06-19RL (or 15;23;26)	Nearest
SAC22	BZW06-23	Nearest
SAC26	BZW06-26	Nearest
SAC30	BZW06-31	Nearest
SAC36	BZW06-40RL	Nearest
SAC45	SMBJ40A-TR	Nearest
SAC5.0	BZW06-5V8	Nearest
SAC50	BZW06-40RL or SMBJ48A-TR	Nearest
SAC6.0	BZW06-5V8	Nearest
SAC7.0	BZW06-10	Nearest
SAC8.0	BZW06-10	Nearest
SAC8.5	BZW06-10	Nearest
SBL10	BZW06-10	Direct
SBL100	P6KE150A	Nearest
SBL100C	P6KE150A	Nearest
SBL10C	BZW06-10	Direct
SBL25	BZW06-26	Direct
SBL25C	BZW06-26	Direct
SDC15	ESDA14V2L	Direct
SGT06U13	SMP100LC-65	Nearest
SGT23B13	SMP100LC-230	Nearest
SGT23U13	SMP100LC-230	Nearest
SGT27B13	SMP100LC-270	Nearest
SICT-45	1.5KE56A	Nearest
SICT-45C	1.5KE56CARL	Nearest
SICT-5	1N5908	Nearest
SICT-8	1.5KE10A	Nearest
SICT-8C	1.5KE7V5CA	Nearest
SICTE-45	1.5KE56A	Direct
SICTE-45C	1.5KE56CARL	Direct
SICTE-5	1N5908	Direct
SICTE-8	1.5KE10A	Direct
SICTE-8C	1.5KE7V5CA	Nearest

Industry standard	ST part numbers	ST equivalence
SLC170	1.5KE200A	Nearest
SLC170A	1.5KE200A	Nearest
SLC6.5	1.5KE6V8A	Nearest
SLC6.5A	1.5KE6V8A	Nearest
SLCE170	1.5KE200A	Nearest
SLCE170A	1.5KE200A	Nearest
SLCE6.5	1.5KE6V8A	Nearest
SLCE6.5A	1.5KE6V8A	Nearest
SLVDA2.8	ESDA6V1-5W6	Nearest
SLVDA3.3	ESDA6V1-5W6	Nearest
SM05	ESDA6V1L	Direct
SM4T	SMAJ series	Nearest
SMAJ100A	SMAJ100A-TR	Direct
SMAJ100CA	SMAJ130CA-TR	Nearest
SMAJ10A	SMAJ12A-TR	Nearest
SMAJ10CA	SMAJ10CA-TR	Direct
SMAJ110A	SMAJ100A-TR	Nearest
SMAJ110CA	SMAJ130CA-TR	Nearest
SMAJ11A	SMAJ12A-TR	Nearest
SMAJ11CA	SMAJ10CA-TR	Direct
SMAJ120A	SM6T150A	Nearest
SMAJ120CA	SMAJ130CA-TR	Nearest
SMAJ12A	SMAJ12A-TR	Direct
SMAJ12CA	SMAJ12CA-TR	Direct
SMAJ130A	SM6T150A	Nearest
SMAJ130CA	SMAJ130CA-TR	Direct
SMAJ13A	SMAJ13A-TR	Direct
SMAJ13CA	SMAJ13CA-TR	Direct
SMAJ14A	SMAJ13A-TR	Nearest
SMAJ14CA	SMAJ13CA-TR	Nearest
SMAJ150A	SMAJ154A-TR	Direct
SMAJ150CA	SMAJ170CA-TR	Nearest
SMAJ15A	SMAJ15A-TR	Direct
SMAJ15CA	SMAJ15CA-TR	Direct
SMAJ160A	SMAJ154A-TR	Nearest
SMAJ160CA	SMAJ170CA-TR	Nearest
SMAJ16A	SMAJ15A-TR	Nearest
SMAJ16CA	SMAJ15CA-TR	Nearest
SMAJ170A	SMAJ170A-TR	Direct
SMAJ170CA	SMAJ170CA-TR	Direct
SMAJ17A	SMAJ18A-TR	Nearest
SMAJ17CA	SMAJ18CA-TR	Nearest
SMAJ18A	SMAJ18A-TR	Direct
SMAJ18CA	SMAJ18CA-TR	Direct
SMAJ20A	SMAJ20A-TR	Direct
SMAJ20CA	SMAJ18CA-TR or SMAJ22CA-TR	Nearest
SMAJ22A	SMAJ24A-TR	Nearest
SMAJ22CA	SMAJ22CA-TR	Direct
SMAJ24A	SMAJ24A-TR	Direct
SMAJ24CA	SMAJ24CA-TR	Direct
SMAJ26A	SMAJ26A-TR	Direct
SMAJ26CA	SMAJ26CA-TR	Direct
SMAJ28A	SMAJ28A-TR	Direct

Cross-reference

Industry standard	ST part numbers	ST equivalence
SMAJ28CA	SMAJ28CA-TR	Direct
SMAJ30A	SMAJ30A-TR	Direct
SMAJ30CA	SMAJ30CA-TR	Direct
SMAJ33A	SMAJ33A-TR	Direct
SMAJ33CA	SMAJ33CA-TR	Direct
SMAJ36A	SMAJ33A-TR	Direct
SMAJ36CA	SMAJ33CA-TR	Direct
SMAJ40A	SMAJ40A-TR	Direct
SMAJ40CA	SMAJ40CA-TR	Direct
SMAJ43A	SMAJ43A-TR	Direct
SMAJ43CA	SMAJ43CA-TR	Direct
SMAJ45A	SMAJ48A-TR	Direct
SMAJ45CA	SMAJ48CA-TR	Direct
SMAJ48A	SMAJ48A-TR	Direct
SMAJ48CA	SMAJ48CA-TR	Direct
SMAJ5.0A	SMAJ5.0A-TR	Direct
SMAJ5.0CA	SMAJ5.0CA-TR	Direct
SMAJ51A	SMAJ48A-TR	Nearest
SMAJ51CA	SMAJ48CA-TR	Nearest
SMAJ54A	SMAJ58A-TR	Nearest
SMAJ54CA	SMAJ58CA-TR	Nearest
SMAJ58A	SMAJ58A-TR	Direct
SMAJ58CA	SMAJ58CA-TR	Direct
SMAJ6.0A	SMAJ6.0A-TR	Direct
SMAJ6.0CA	SMAJ6.0CA-TR	Direct
SMAJ6.5A	SMAJ6.5A-TR	Direct
SMAJ6.5CA	SMAJ6.5CA-TR	Direct
SMAJ60A	SMAJ58A-TR	Nearest
SMAJ60CA	SMAJ58CA-TR	Nearest
SMAJ64A	SMAJ70A-TR	Nearest
SMAJ64CA	SMAJ70CA-TR	Nearest
SMAJ7.0A	SMAJ6.5A-TR	Nearest
SMAJ7.0CA	SMAJ6.5CA-TR	Nearest
SMAJ7.5A	SMAJ6.5A-TR	Nearest
SMAJ7.5CA	SMAJ6.5CA-TR	Nearest
SMAJ70A	SMAJ70A-TR	Direct
SMAJ70CA	SMAJ70CA-TR	Direct
SMAJ75A	SMAJ70A-TR	Nearest
SMAJ75CA	SMAJ70CA-TR	Nearest
SMAJ78A	SMAJ85A-TR	Nearest
SMAJ78CA	SMAJ85CA-TR	Nearest
SMAJ8.0A	SM6T12A or SMAJ12A-TR	Nearest
SMAJ8.0CA	SMAJ8.5CA-TR	Nearest
SMAJ8.5A	SM6T12A or SMAJ12A-TR	Nearest
SMAJ8.5CA	SMAJ8.5CA-TR	Direct
SMAJ85A	SMAJ85A-TR	Direct
SMAJ85CA	SMAJ85CA-TR	Direct
SMAJ9.0A	SM6T12A or SMAJ12A-TR	Nearest
SMAJ9.0CA	SMAJ8.5CA-TR	Nearest
SMAJ90A	SMAJ85A-TR	Nearest
SMAJ90CA	SMAJ85CA-TR	Nearest

Industry standard	ST part numbers	ST equivalence
SMBG	SMBJ or SM6T series	Nearest
SMBJ	SMBJ or SM6T series	Direct
SMBJ100A	SMBJ130A-TR	Nearest
SMBJ100CA	SMBJ100CA-TR	Direct
SMBJ10A	SM6T12A	Direct
SMBJ10A	SMBJ10A-TR	Direct
SMBJ10CA	SM6T12CA	Direct
SMBJ10CA	SMBJ10CA-TR	Direct
SMBJ110A	SMBJ130A-TR	Nearest
SMBJ110CA	SMBJ100CA-TR	Nearest
SMBJ11A	SM6T12A	Nearest
SMBJ11A	SMBJ10A-TR	Nearest
SMBJ11CA	SM6T12CA	Nearest
SMBJ11CA	SMBJ10CA-TR	Nearest
SMBJ120A	SMBJ130A-TR	Nearest
SMBJ120CA	SMBJ170CA-TR	Nearest
SMBJ12A	SM6T15A	Nearest
SMBJ12A	SMBJ12A-TR	Direct
SMBJ12CA	SM6T15CA	Nearest
SMBJ12CA	SMBJ12CA-TR	Direct
SMBJ130A	SM6T150A	Direct
SMBJ130A	SMBJ130A-TR	Direct
SMBJ130CA	SM6T150CA	Direct
SMBJ130CA	SMBJ170CA-TR	Nearest
SMBJ13A	SM6T15A	Direct
SMBJ13A	SMBJ13A-TR	Direct
SMBJ13CA	SM6T15CA	Direct
SMBJ13CA	SMBJ13CA-TR	Direct
SMBJ14A	SM6T15A	Nearest
SMBJ14A	SMBJ13A-TR	Nearest
SMBJ14CA	SM6T15CA	Nearest
SMBJ14CA	SMBJ13CA-TR	Nearest
SMBJ150A	SMBJ154A-TR	Direct
SMBJ150CA	P6KE150CA or SMBJ170CA-TR	Nearest
SMBJ15A	SM6T18A	Direct
SMBJ15A	SMBJ15A-TR	Direct
SMBJ15CA	SM6T18CA	Direct
SMBJ15CA	SMBJ15CA-TR	Direct
SMBJ160A	SMBJ154A-TR	Nearest
SMBJ160CA	P6KE150CA or SMBJ170CA-TR	Nearest
SMBJ16A	SM6T18A	Nearest
SMBJ16A	SMBJ15A-TR	Nearest
SMBJ16CA	SM6T18CA	Nearest
SMBJ16CA	SMBJ15CA-TR	Nearest
SMBJ170A	SMBJ170A-TR	Direct
SMBJ170CA	SMBJ170CA-TR	Direct
SMBJ17A	SM6T22A	Nearest
SMBJ17A	SMBJ18A-TR	Nearest
SMBJ17CA	SM6T22CA	Nearest
SMBJ17CA	SMBJ18CA-TR	Nearest

Industry standard	ST part numbers	ST equivalence
SMBJ18A	SM6T22A	Direct
SMBJ18A	SMBJ18A-TR	Direct
SMBJ18CA	SM6T22CA	Direct
SMBJ18CA	SMBJ18CA-TR	Direct
SMBJ20A	SM6T24A	Direct
SMBJ20A	SMBJ20A-TR	Direct
SMBJ20CA	SM6T24CA	Direct
SMBJ20CA	SMBJ20CA-TR	Direct
SMBJ22A	SM6T27A	Nearest
SMBJ22A	SMBJ22A-TR	Direct
SMBJ22CA	SM6T27CA	Nearest
SMBJ22CA	SMBJ24CA-TR	Nearest
SMBJ24A	SM6T27A	Nearest
SMBJ24A	SMBJ24A-TR	Direct
SMBJ24CA	SM6T27CA	Nearest
SMBJ24CA	SMBJ24CA-TR	Direct
SMBJ26A	SM6T30A	Direct
SMBJ26A	SMBJ26A-TR	Direct
SMBJ26CA	SM6T30CA	Direct
SMBJ26CA	SMBJ24CA-TR or SMBJ30CA-TR	Nearest
SMBJ28A	SM6T33A	Direct
SMBJ28A	SMBJ28A-TR	Direct
SMBJ28CA	SM6T33CA	Direct
SMBJ28CA	SMBJ28CA-TR	Direct
SMBJ30A	SM6T36A	Direct
SMBJ30A	SMBJ30A-TR	Direct
SMBJ30CA	SM6T36CA	Direct
SMBJ30CA	SMBJ30CA-TR	Direct
SMBJ33A	SM6T39A	Direct
SMBJ33A	SMBJ33A-TR	Direct
SMBJ33CA	SM6T39CA	Direct
SMBJ33CA	SMBJ33CA-TR	Direct
SMBJ36A	SMBJ33A-TR	Nearest
SMBJ36CA	SMBJ33CA-TR	Nearest
SMBJ40A	SMBJ40A-TR	Direct
SMBJ40CA	SMBJ40CA-TR	Direct
SMBJ43A	SMBJ40A-TR	Nearest
SMBJ43CA	SMBJ40CA-TR	Nearest
SMBJ45A	SMBJ48A-TR	Nearest
SMBJ45CA	SMBJ48CA-TR	Nearest
SMBJ48A	SMBJ48A-TR	Direct
SMBJ48CA	SMBJ48CA-TR	Direct
SMBJ5.0A	SMBJ5.0A-TR	Direct
SMBJ5.0CA	SMBJ5.0CA-TR	Direct
SMBJ51A	SMBJ48A-TR	Nearest
SMBJ51CA	SMBJ48CA-TR	Nearest
SMBJ54A	SMBJ58A-TR	Nearest
SMBJ54CA	SMBJ58CA-TR	Nearest
SMBJ58A	SM6T68A	Direct
SMBJ58A	SMBJ58A-TR	Direct
SMBJ58CA	SM6T68CA	Direct
SMBJ58CA	SMBJ58CA-TR	Direct
SMBJ6.0A	SM6T6V8A	Direct

Industry standard	ST part numbers	ST equivalence
SMBJ6.0A	SMBJ6.0A-TR	Direct
SMBJ6.0CA	SM6T6V8CA	Direct
SMBJ6.0CA	SMBJ6.0CA-TR	Direct
SMBJ6.5A	SM6T7V5A	Direct
SMBJ6.5A	SMBJ6.5A-TR	Direct
SMBJ6.5CA	SM6T7V5CA	Direct
SMBJ6.5CA	SMBJ6.5CA-TR	Direct
SMBJ60A	SMBJ58A-TR	Nearest
SMBJ60CA	SMBJ58CA-TR	Nearest
SMBJ64A	SMBJ70A-TR	Nearest
SMBJ64CA	SMBJ70CA-TR	Nearest
SMBJ7.0A	SM6T7V5A	Nearest
SMBJ7.0A	SMBJ6.5A-TR	Nearest
SMBJ7.0CA	SM6T7V5CA	Nearest
SMBJ7.0CA	SMBJ6.5CA-TR	Nearest
SMBJ7.5A	SM6T10A	Nearest
SMBJ7.5A	SMBJ8.5A-TR	Nearest
SMBJ7.5CA	SM6T10CA	Nearest
SMBJ7.5CA	SMBJ8.5CA-TR	Nearest
SMBJ70A	SMBJ70A-TR	Direct
SMBJ70CA	SMBJ70CA-TR	Direct
SMBJ75A	SMBJ70A-TR	Nearest
SMBJ75CA	SMBJ70CA-TR	Nearest
SMBJ78A	SMBJ85A-TR	Nearest
SMBJ78CA	SMBJ85CA-TR	Nearest
SMBJ8.0A	SM6T10A	Nearest
SMBJ8.0A	SMBJ8.5A-TR	Nearest
SMBJ8.0CA	SM6T10CA	Nearest
SMBJ8.0CA	SMBJ8.5CA-TR	Nearest
SMBJ8.5A	SM6T10A	Direct
SMBJ8.5A	SMBJ8.5A-TR	Direct
SMBJ8.5CA	SM6T10CA	Direct
SMBJ8.5CA	SMBJ8.5CA-TR	Direct
SMBJ85A	SM6T100A	Direct
SMBJ85A	SMBJ85A-TR	Direct
SMBJ85CA	SM6T100CA	Direct
SMBJ85CA	SMBJ85CA-TR	Direct
SMBJ9.0A	SM6T10A	Nearest
SMBJ9.0A	SMBJ8.5A-TR	Nearest
SMBJ9.0CA	SM6T10CA	Nearest
SMBJ9.0CA	SMBJ8.5CA-TR	Nearest
SMBJ90A	SMBJ85A-TR	Nearest
SMBJ90CA	SMBJ85CA-TR	Nearest
SMCG	SMCJ or SM15T series	Nearest
SMCJ	SMCJ or SM15T series	Direct
SMCJ100A	SM15T200A	Nearest
SMCJ100CA	SM15T150CA	Nearest
SMCJ10A	SM15T12A	Direct
SMCJ10A	SMCJ10A-TR	Direct
SMCJ10CA	SM15T12CA	Direct
SMCJ10CA	SMCJ10CA-TR	Direct
SMCJ110A	SM15T200A	Nearest

Cross-reference

Industry standard	ST part numbers	ST equivalence
SMCJ110CA	SM15T150CA	Nearest
SMCJ11A	SM15T15A	Nearest
SMCJ11A	SMCJ13A-TR	Nearest
SMCJ11CA	SM15T15CA	Nearest
SMCJ11CA	SMCJ13CA-TR	Nearest
SMCJ120A	SM15T200A	Nearest
SMCJ120A	SM15T200A	Nearest
SMCJ120CA	SM15T150CA	Nearest
SMCJ120CA	SMCJ130CA-TR	Nearest
SMCJ12A	SM15T15A	Nearest
SMCJ12A	SMCJ13A-TR	Nearest
SMCJ12CA	SM15T15CA	Nearest
SMCJ12CA	SMCJ13CA-TR	Nearest
SMCJ130A	SM15T200A	Direct
SMCJ130CA	SM15T150CA	Direct
SMCJ130CA	SMCJ130CA-TR	Direct
SMCJ13A	SM15T15A	Direct
SMCJ13A	SMCJ13A-TR	Direct
SMCJ13CA	SM15T15CA	Direct
SMCJ13CA	SMCJ13CA-TR	Direct
SMCJ14A	SM15T15A	Nearest
SMCJ14A	SMCJ13A-TR	Nearest
SMCJ14CA	SM15T15CA	Nearest
SMCJ14CA	SMCJ13CA-TR	Nearest
SMCJ150A	SM15T200A	Nearest
SMCJ150CA	SM15T200CA	Nearest
SMCJ15A	SM15T18A	Direct
SMCJ15A	SMCJ15A-TR	Direct
SMCJ15CA	SM15T18CA	Direct
SMCJ15CA	SMCJ15CA-TR	Direct
SMCJ160A	SM15T200A	Nearest
SMCJ160CA	SM15T200CA	Nearest
SMCJ16A	SM15T18A	Nearest
SMCJ16A	SMCJ15A-TR	Nearest
SMCJ16CA	SM15T18CA	Nearest
SMCJ16CA	SMCJ15CA-TR	Nearest
SMCJ170A	SM15T200A	Direct
SMCJ170A	SMCJ170A-TR	Direct
SMCJ170CA	SM15T200A	Direct
SMCJ170CA	SM15T200CA	Direct
SMCJ17A	SMCJ15A-TR or SMCJ22A-TR	Nearest
SMCJ17CA	SMCJ18CA-TR	Nearest
SMCJ18A	SMCJ15A-TR or SMCJ22A-TR	Nearest
SMCJ18CA	SMCJ18CA-TR	Direct
SMCJ20A	SMCJ22A-TR	Nearest
SMCJ20CA	SMCJ24CA-TR or SMCJ18CA-TR	Nearest
SMCJ22A	SMCJ22A-TR	Direct
SMCJ22CA	SMCJ24CA-TR	Direct
SMCJ24A	SMCJ26A-TR	Direct
SMCJ24CA	SMCJ24CA-TR	Direct
SMCJ26A	SMCJ26A-TR	Direct

Industry standard	ST part numbers	ST equivalence
SMCJ26CA	SMCJ24CA-TR	Nearest
SMCJ28A	SM15T33A	Direct
SMCJ28A	SMCJ28A-TR	Direct
SMCJ28CA	SM15T33CA	Direct
SMCJ28CA	SMCJ30CA-TR	Nearest
SMCJ30A	SMCJ30A-TR	Direct
SMCJ30CA	SMCJ30CA-TR	Direct
SMCJ33A	SM15T39A	Direct
SMCJ33A	SMCJ33A-TR	Direct
SMCJ33CA	SM15T39CA	Direct
SMCJ33CA	SMCJ33CA-TR	Direct
SMCJ36A	SM15T39A	Nearest
SMCJ36A	SMCJ33A-TR	Nearest
SMCJ36CA	SM15T39CA	Nearest
SMCJ36CA	SMCJ33CA-TR	Nearest
SMCJ40A	SMCJ40A-TR	Direct
SMCJ40CA	SMCJ40CA-TR	Direct
SMCJ43A	SMCJ40A-TR	Nearest
SMCJ43CA	SMCJ40CA-TR	Nearest
SMCJ45A	SM15T68A	Nearest
SMCJ45CA	SMCJ48CA-TR	Nearest
SMCJ48A	SM15T68A	Nearest
SMCJ48CA	SM15T68A	Nearest
SMCJ5.0A	SMCJ5.0A-TR	Direct
SMCJ5.0CA	SMCJ5.0CA-TR	Direct
SMCJ51A	SM15T68A	Nearest
SMCJ51CA	SMCJ48CA-TR	Nearest
SMCJ54A	SM15T68A	Nearest
SMCJ54CA	SMCJ70CA-TR	Nearest
SMCJ58A	SM15T68A	Direct
SMCJ58CA	SM15T68CA	Direct
SMCJ58CA	SMCJ70CA-TR	Direct
SMCJ6.0A	SMCJ6.0A-TR	Direct
SMCJ6.0CA	SMCJ6.0CA-TR	Direct
SMCJ6.5A	SM15T6V8A	Direct
SMCJ6.5CA	SM15T7V5CA	Nearest
SMCJ60A	SM15T68A	Nearest
SMCJ60CA	SM15T68CA	Nearest
SMCJ60CA	SMCJ70CA-TR	Nearest
SMCJ64A	SMCJ70A-TR	Nearest
SMCJ64CA	SMCJ70CA-TR	Nearest
SMCJ7.0A	SM15T6V8A	Nearest
SMCJ7.0A	SM15T7V5A	Nearest
SMCJ7.0CA	SM15T7V5CA	Nearest
SMCJ7.5A	SM15T6V8A	Nearest
SMCJ7.5A	SM15T7V5A	Nearest
SMCJ7.5CA	SM15T6V8A	Nearest
SMCJ7.5CA	SM15T7V5CA	Nearest
SMCJ70A	SMCJ70A-TR	Direct
SMCJ70CA	SMCJ70CA-TR	Direct
SMCJ75A	SMCJ70A-TR	Nearest
SMCJ75CA	SMCJ70CA-TR	Nearest
SMCJ78A	SM15T100A	Nearest
SMCJ78CA	SM15T100CA	Nearest

Industry standard	ST part numbers	ST equivalence
SMCJ78CA	SMCJ85CA-TR	Nearest
SMCJ8.0A	SM15T10A	Nearest
SMCJ8.0A	SM15T10A or SMCJ10A-TR	Nearest
SMCJ8.0CA	SM15T10CA	Nearest
SMCJ8.0CA	SM15T7V5CA	Nearest
SMCJ8.5A	SM15T10A	Direct
SMCJ8.5A	SM15T10A or SMCJ10A-TR	Direct
SMCJ8.5CA	SM15T10CA	Direct
SMCJ85A	SM15T100A	Direct
SMCJ85CA	SM15T100CA	Direct
SMCJ85CA	SMCJ85CA-TR	Direct
SMCJ9.0A	SM15T12A	Nearest
SMCJ9.0A	SMCJ10A-TR	Nearest
SMCJ9.0CA	SM15T12CA	Nearest
SMCJ9.0CA	SMCJ10CA-TR	Nearest
SMCJ90A	SM15T100A	Nearest
SMCJ90CA	SMCJ85CA-TR	Nearest
SMDA05	ITA6V5B1	Nearest
SMDA05-18	ESDA6V1S3	Direct
SMDA05-6	ESDA6V1U1	Direct
SMDA05C	ITA6V5B1	Direct
SMDA05C-4-2	ITA6V5B1	Direct
SMDA05C-5	ESDA6V1U1	Direct
SMDA05C-5	ITA6V5B1	Direct
SMDA05C-7	ESDA6V1-5W6	Direct
SMDA05C-8	ESDA6V1BC6	Nearest
SMDA05C-8	ITA6V5B3	Nearest
SMDA12C-5	ITA10B1	Nearest
SMDA12C-8	ITA6V5B3	Nearest
SMDA15	ITA18B1	Nearest
SMDA15C	ITA18B1	Direct
SMDA15C-4-2	ITA18B1	Direct
SMDA15C-5	ITA18B1	Direct
SMDA15C-8	ITA18B3	Nearest
SMDA24	ITA25B1	Nearest
SMDA24C	ITA25B1	Direct
SMDA24C-4-2	ITA25B1	Direct
SMDA24C-5	ITA25B1	Direct
SMDA24C-5	ESDA25B1	Direct
SMDA24C-7	ESDA25B1	Direct
SMDA24C-8	ESDA25B1	Nearest
SMF05	ESDA6V1SC5	Direct
SMF05C	ESDA6V1-5W6	Direct
SMMG	SMCJ or SM15T series	Nearest
SMMJ	SMCJ or SM15T series	Direct
SMS05	ESDA6V1SC6	Direct
SMS12	ESDA14V2SC6	Direct
SMS15	ESDA14V2SC6	Nearest
SMSG	SMBJ or SM6T series	Nearest

Industry standard	ST part numbers	ST equivalence
SMSJ	SMBJ or SM6T series	Direct
SOV10	P6KE12ARL	Nearest
SOV12	P6KE15A	Nearest
SOV15	P6KE18A	Nearest
SOV18	P6KE18A	Nearest
SOV24	P6KE27A	Nearest
SOV28	P6KE33A	Nearest
SOV5.0	1N5908	Nearest
SR05	USBLC6-2SC6	Nearest
SRDAxx-4	DA108S1	Nearest
SRDAxx-6	DA112S1	Nearest
SRV05-4	USBLC6-4SC6	Direct
T10A110	TPA100	Direct
T10A140	TPA130	Direct
T10A180	TPA180	Nearest
T10A220	TPA200	Direct
T10A270	TPA270	Direct
T10A80	TPA68	Nearest
T10Bxx	SMP100LC-270	Nearest
TCM1030D	LCP1521S	Direct
TCM1030P	LCP1521S	Nearest
TCM1060D	LCP1521S	Direct
TCM1060P	LCP1521S	Nearest
TGL41	SMAJ series	Nearest
TIPS61089AS	LCP1521S	Direct
TIPS61089S	LCP1521S	Direct
TISP1072F3D	THDT6511DRL	Nearest
TISP1072F3P	THDT6511DRL	Nearest
TISP1082F3D	THDT6511DRL	Nearest
TISP1082F3P	THDT6511DRL	Nearest
TISP1082F3SL	LCP1521S	Nearest
TISP2180	TLP140G-1	Direct
TISP2180L	THBT15011D	Nearest
TISP2180L	TLP140G	Nearest
TISP2290	TLP200G-1	Direct
TISP2290L	THBT20011D	Nearest
TISP2290L	TLP200G	Nearest
TISP2310L	THBT27011D	Nearest
TISP2310L	TLP270G	Nearest
TISP3072F3D	SMTPA62	Nearest
TISP3072F3P	TPA62	Nearest
TISP3072F3SL	TPA62	Nearest
TISP3082	TPA62	Nearest
TISP3082F3D	SMTPA62	Nearest
TISP3082F3P	TPA62	Nearest
TISP3082F3SL	TPA62	Nearest
TISP3082LP	SMTPA62	Nearest
TISP3125F3D	SMTPA100	Nearest
TISP3125F3P	TPA100	Nearest
TISP3125F3SL	TPA100	Nearest
TISP3150F3D	SMTPA120	Nearest
TISP3150F3P	TPA120	Nearest
TISP3150F3SL	TPA120	Nearest

Cross-reference

Industry standard	ST part numbers	ST equivalence
TISP3180	TPA180	Nearest
TISP3180F3D	SMTPA130	Nearest
TISP3180F3P	TPA130	Nearest
TISP3180F3SL	TPA130	Nearest
TISP3180L	SMTPA180	Nearest
TISP3240F3D	SMTPA180	Nearest
TISP3240F3P	TPA180	Nearest
TISP3240F3SL	TPA180	Nearest
TISP3260F3SL	SMTPA200	Nearest
TISP3290	TPA220	Nearest
TISP3290F3D	SMTPA220	Nearest
TISP3290F3P	TPA220	Nearest
TISP3290F3SL	TLP200G-1	Direct
TISP3290L	SMTPA220	Nearest
TISP3320F3D	SMTPA220 or SMP100LC-230	Nearest
TISP3320F3P	TPA240	Nearest
TISP3320F3SL	TPA240	Nearest
TISP3360F3D	TPA200	Nearest
TISP3360F3SL	TPA200	Nearest
TISP3380F3D	SMTPA270 or SMP100LC-270	Nearest
TISP3380F3P	TPA270	Nearest
TISP3380F3SL	TPA270	Nearest
TISP4015H1BJR	SMP100LC-8	Direct
TISP4030H1BJR	SMP100LC-25	Direct
TISP4040H1BJR	SMP100LC-25	Direct
TISP4070H3BJR	SMP100LC-65	Direct
TISP4070L3AJR	SMP30-62	Direct
TISP4070L3BJR	SMP30-62	Nearest
TISP4070M3AJR	SMP50-62	Direct
TISP4080H3BJR	SMP100LC-65	Direct
TISP4080L3AJR	SMP30-68	Direct
TISP4080L3BJR	SMP30-68	Nearest
TISP4080M3ABJR	SMTPA62	Direct
TISP4080M3AJR	SMP50-68	Direct
TISP4090L3AJR	SMP30-68	Direct
TISP4090L3BJR	SMP30-68	Nearest
TISP4095H3BJR	SMP100LC-65	Direct
TISP4095M3ABJR	SMTPA68	Direct
TISP4095M3AJR	SMP50-68	Direct
TISP4095M3AJR	SMP50-100	Direct
TISP4115H3BJR	SMP100LC-90	Direct
TISP4115M3ABJR	SMTPA100	Direct
TISP4115M3AJR	SMP50-100	Direct
TISP4125H3BJR	SMP100LC-90	Direct
TISP4125L3AJR	SMP30-100	Direct
TISP4125L3BJR	SMP30-100	Nearest
TISP4125M3ABJR	SMTPA100	Direct
TISP4125M3AJR	SMP50-120	Direct
TISP4145H3BJR	SMP100LC-120	Direct
TISP4145L3AJR	SMP30-120	Direct
TISP4145L3BJR	SMP30-120	Nearest
TISP4145M3ABJR	SMTPA120	Direct

Industry standard	ST part numbers	ST equivalence
TISP4145M3AJR	SMP50-130	Direct
TISP4165H3BJR	SMP100LC-140	Direct
TISP4165H4BJR	SMP100LC-140	Nearest
TISP4165L3AJR	SMP30-120	Direct
TISP4165L3BJR	SMP30-120	Nearest
TISP4165M3ABJR	SMTPA130	Direct
TISP4165M3AJR	SMP50-130	Direct
TISP4180H3BJR	SMP100LC-160	Direct
TISP4180H4BJR	SMP100LC-160	Nearest
TISP4180L3AJR	SMP30-1230	Direct
TISP4180L3BJR	SMP30-1230	Nearest
TISP4180M3ABJR	SMTPA130	Direct
TISP4200H3BJR	SMP100LC-160	Direct
TISP4200H4BJR	SMP100LC-160	Nearest
TISP4219H3BJR	SMP100LC-160	Direct
TISP4219M3AJR	SMP50-180	Direct
TISP4220H3BJR	SMP100LC-160	Direct
TISP4220L3AJR	SMP30-180	Direct
TISP4220L3BJR	SMP30-180	Nearest
TISP4220M3ABJR	SMTPA180	Direct
TISP4220M3AJR	SMP50-180	Direct
TISP4240H3BJR	SMP100LC-200	Direct
TISP4240L3AJR	SMP30-180	Direct
TISP4240L3BJR	SMP30-180	Nearest
TISP4240M3ABJR	SMTPA180	Direct
TISP4240M3AJR	SMP50-200	Direct
TISP4250H3BJR	SMP100LC-200	Direct
TISP4250M3ABJR	SMTPA200	Direct
TISP4250M3AJR	SMP50-200	Direct
TISP4260H3BJR	SMP100LC-200	Direct
TISP4260L3AJR	SMP30-200	Direct
TISP4260L3BJR	SMP30-200	Nearest
TISP4260M3ABJR	SMTPA200	Direct
TISP4260M3AJR	SMP50-200	Direct
TISP4265H3BJR	SMP100LC-200	Direct
TISP4265H4BJR	SMP100LC-200	Nearest
TISP4265M3ABJR	SMTPA200	Direct
TISP4265M3AJR	SMP50-220	Direct
TISP4290H3BJR	SMP100LC-230	Direct
TISP4290L3AJR	SMP30-220	Direct
TISP4290L3BJR	SMP30-220	Nearest
TISP4290M3ABJR	SMTPA220	Direct
TISP4290M3AJR	SMP50-220	Direct
TISP4290T3BJR	SMP80MC-230	Direct
TISP4300H3BJR	SMP100LC-230	Direct
TISP4300H4BJR	SMP100LC-230	Nearest
TISP4300M3ABJR	SMTPA220	Direct
TISP4300M3AJR	SMP50-220	Direct
TISP4300MMAJR	SMP50-270	Direct
TISP4300MMBJR	SMTPA220	Direct
TISP4320L3AJR	SMP30-240	Direct
TISP4320L3BJR	SMP30-240	Nearest
TISP4350H3BJR	SMP100LC-270	Direct
TISP4350H4BJR	SMP100LC-270	Nearest

Industry standard	ST part numbers	ST equivalence
TISP4350L3AJR	SMP30-270	Direct
TISP4350L3BJR	SMP30-270	Nearest
TISP4350M3ABJR	SMPA270	Direct
TISP4350M3AJR	SMP50-270	Direct
TISP4350MMAJR	SMP50-270	Direct
TISP4350MMBJR	SMPA270	Direct
TISP4350T3BJR	SMP80MC-270	Direct
TISP4360H3BJR	SMP100LC-270	Direct
TISP4360M3ABJR	SMPA270	Direct
TISP4360M3AJR	SMP50-270	Direct
TISP4360MMBJR	SMPA270	Direct
TISP4395H3BJR	SMP100LC-320	Direct
TISP4400H3BJR	SMP100LC-360	Direct
TISP4A270H3BJR	SMP100LC-270	Direct
TISP5070H3BJ	SMP100LC-65	Direct
TISP5080H3BJ	SMP100LC-65	Direct
TISP5110H3BJ	SMP100LC-65	Nearest
TISP5150H3BJ	SMP100LC-140	Direct
TISP61060D	LCP1521S	Direct
TISP61060P	LCP1521S	Direct
TISP61089AD	LCP1521S	Direct
TISP61089B	LCP1521S	Direct
TISP61089D	LCP1521S	Direct
TISP61089P	LCP1521S	Direct
TISP61511D	LCP1521S	Direct
TISP61512P	LCP1521S	Direct
TISP61521	LCP1521S	Direct
TISP61CAP3	LCP1521S	Direct
TISP61CAP3P	LCP1521S	Nearest
TISP6L7591	LCP1521S	Direct
TISP6NTP2A	LCDP1511DRL	Direct
TISP6NTP2B	LCDP1511DRL	Nearest
TISP7125F3D	TPI8011N	Nearest
TISP7125F3P	TPI8011N	Nearest
TISP7180F3D	TPI12011N	Nearest
TISP7180F3P	TPI12011N	Nearest
TISP7240F3D	THBT15011D	Nearest
TISP7240F3P	THBT15011D	Nearest
TISP7260F3D	THBT20011D	Nearest
TISP7260F3P	THBT20011D	Nearest
TISP7290F3D	THBT20011D	Nearest
TISP7290F3P	THBT20011D	Nearest
TISP7320F3D	THBT27011D	Nearest
TISP7320F3P	THBT27011D	Nearest
TISP7350F3P	THBT27011D	Nearest
TISP7380F3D	THBT27011D	Nearest
TISP7380F3P	THBT27011D	Nearest
TISP8200M	LCP02-150M	Nearest
TISP8201M	LCP02-150M	Nearest
TISP8250	TPP25011	Direct
TISP83121D	LCP3121	Direct
TISP9110L	LCP02-150B1	Direct
TISPA79R241	LCP1521S	Direct
TISPL758LF3D	SSRP105B1	Direct

Industry standard	ST part numbers	ST equivalence
TISPPBL1	LCP1521S	Direct
TISPPBL2	LCP1521S	Direct
TISPPBL3	LCP1521S	Direct
TISPxxxH3SL	TLP200G-1	Direct
TMPG06-10A	BZW04-10	Direct
TMPG06-11A	BZW04-10	Nearest
TMPG06-12A	BZW04-10	Direct
TMPG06-13A	BZW04-13	Nearest
TMPG06-15A	BZW04-13	Direct
TMPG06-16A	BZW04-15	Nearest
TMPG06-18A	BZW04-15	Direct
TMPG06-20A	BZW04-15 or BZW04-26	Nearest
TMPG06-22A	BZW04-15 or BZW04-26	Nearest
TMPG06-24A	BZW04-20	Direct
TMPG06-27A	BZW04-26	Direct
TMPG06-30A	BZW04-26	Direct
TMPG06-33A	BZW04-33	Direct
TMPG06-36A	BZW04-31	Direct
TMPG06-39A	BZW04-33	Direct
TMPG06-43A	BZW04-40 or BZW04-48	Nearest
TMPG06-6.8A	BZW04-5V8	Direct
TMPG06-7.5A	BZW04-10	Nearest
TMPG06-8.2A	BZW04-10	Nearest
TMPG06-9.1A	BZW04-10	Nearest
TPSMA10A	SM6T12A or SMAJ12A-TR	Nearest
TPSMA11A	SMAJ12A-TR	Nearest
TPSMA12A	SMAJ12A-TR	Direct
TPSMA13A	SMAJ13A-TR	Nearest
TPSMA15A	SMAJ13A-TR	Nearest
TPSMA16A	SMAJ15A-TR	Nearest
TPSMA18A	SMAJ15A-TR	Nearest
TPSMA20A	SMAJ18A-TR	Nearest
TPSMA22A	SMAJ18A-TR	Nearest
TPSMA24A	SMAJ20A-TR	Nearest
TPSMA27A	SMAJ24A-TR	Nearest
TPSMA30A	SMAJ26A-TR	Nearest
TPSMA33A	SMAJ28A-TR	Nearest
TPSMA36A	SMAJ30A-TR	Nearest
TPSMA39A	SMAJ33A-TR	Nearest
TPSMA43A	SMAJ40A-TR	Nearest
TPSMA6.8A	SMAJ6.0A-TR	Nearest
TPSMA7.5A	SMAJ6.5A-TR	Nearest
TPSMA8.2A	SMAJ6.5A-TR	Nearest
TPSMA9.1A	SM6T12A or SMAJ12A-TR	Nearest
TPSMB10A	SMBJ8.5A-TR	Nearest
TPSMB11A	SMBJ10A-TR	Nearest
TPSMB12A	SMBJ10A-TR	Nearest
TPSMB13A	SMBJ13A-TR	Nearest
TPSMB15A	SMBJ13A-TR	Nearest

Cross-reference

Industry standard	ST part numbers	ST equivalence
TPSMB16A	SMBJ15A-TR	Nearest
TPSMB18A	SMBJ15A-TR	Nearest
TPSMB20A	SMBJ18A-TR	Nearest
TPSMB22A	SMBJ18A-TR	Nearest
TPSMB24A	SMBJ20A-TR	Nearest
TPSMB27A	SMBJ24A-TR	Nearest
TPSMB30A	SMBJ26A-TR	Nearest
TPSMB33A	SMBJ28A-TR	Nearest
TPSMB36A	SMBJ30A-TR	Nearest
TPSMB39A	SMBJ33A-TR	Nearest
TPSMB43A	SMBJ40A-TR	Nearest
TPSMB6.8A	SMBJ6.0A-TR	Nearest
TPSMB7.5A	SMBJ6.5A-TR	Nearest
TPSMB8.2A	SMBJ6.5A-TR	Nearest
TPSMB9.1A	SMBJ8.5A-TR	Nearest
TPSMC10A	SM15T10A or SMCJ10A-TR	Nearest
TPSMC11A	SMCJ10A-TR	Nearest
TPSMC12A	SMCJ10A-TR	Nearest
TPSMC13A	SMCJ13A-TR	Nearest
TPSMC15A	SMCJ13A-TR	Nearest
TPSMC16A	SMCJ15A-TR	Nearest
TPSMC18A	SMCJ15A-TR	Nearest
TPSMC20A	SMCJ15A-TR or SMCJ22A-TR	Nearest
TPSMC22A	SMCJ15A-TR or SMCJ22A-TR	Nearest
TPSMC24A	SMCJ22A-TR	Nearest
TPSMC27A	SMCJ26A-TR	Nearest
TPSMC30A	SMCJ26A-TR	Nearest
TPSMC33A	SMCJ28A-TR	Nearest
TPSMC36A	SMCJ30A-TR	Nearest

Industry standard	ST part numbers	ST equivalence
TPSMC39A	SMCJ33A-TR	Nearest
TPSMC43A	SMCJ40A-TR	Nearest
TPSMC6.8A	SMCJ6.0A-TR	Nearest
TPSMC7.5A	SM15T6V8A	Nearest
TPSMC8.2A	SM15T6V8A	Nearest
TPSMC9.1A	SM15T10A or SMCJ10A-TR	Nearest
T SMA	SMAJ series	Nearest
T SMB	SM6T series	Nearest
T SMC	SM15T series	Nearest
TVS505	BZW04-5V8	Direct
TVS528	BZW04-26	Nearest
TVS528	BZW04-26 or BZW04-33	Nearest
T ZB	BZW04 series	Direct
UMZ6.8EN	ESDALC6V1F1	Direct
USB0805	ESDA6V1-5W6	Nearest
Z1	BZW04 series	Direct
Z2	P6KE series	Direct
ZD024	BZW04-23B	Direct
ZD068	BZW04-70B	Direct
ZP1	P6KE series	Direct
ZP2	1.5KE series	Direct
ZP3	BZW50 series	Direct
ZP5027S	LDP24A	Direct
ZP5028S	LDP24A	Direct
ZP5030S	LDP24A	Direct
ZZ-16	P6KE18CA	Direct
ZZ-160	P6KE150CA or P6KE200CA	Nearest
ZZ-36	P6KE36CA	Direct
ZZ-62	P6KE68CARL	Nearest

Application notes

Title	Ref.
Transil clamping protection mode	AN316
Protection by transil	AN317
Relay drive protection	AN319
Trisil crowbar type protection diode	AN320
SLIC protection	AN386
Transistor protection by transil-power and surge current duration	AN444
Protection standard applicable to automobiles	AN553
Choice of protection in automotive applications	AN554
Automotive protection with the RBOX series	AN555
Transil trisil comparison	AN574
Calculation of transil apparent dynamic resistance	AN575
PCB layout optimisation	AN576
Packaging and soldering method devices in SMA, SMB and SMC packages	AN577
Power crossing behaviour of line car protection	AN578
Protection concepts in telecommunications equipment	AN579
Voltage to current waveform conversion	AN580
Protection standards applicable to terminals	AN581
Protection schematics for telephone set	AN582
Protection standards applicable to switching equipment	AN583
Protection schematics for switching system	AN584
ISDN interface protection	AN585
Use of transil as rectifier diodes	AN586
Transistor protection by transil	AN587
Input/output protection for automotive computer	AN820
New layout insulation requirement	AN821
Alternator load dump protection with APC concept	AN837
Concept and use of CLP200M for overvoltage and overcurrent protection	AN1023
PSA cover tape	AN1025
Linecard protection by overvoltage and overcurrent with a CLP270M	AN1220
Flip-Chip CSP: package description and recommendations for use	AN1235
Axial plastic diodes: precautions for lead bending and cutting	AN1471
EMI Filters: recommendations and measurements	AN1751
How to make fire-wire communication port safe?	AN1783
Transient protection solutions: transil diode versus varistor	AN1826
SLIC protection for both classical and new networks	AN2053
Compliance of series/parallel protections for telecom co	AN2064
DVI ESD Protection demonstration board	AN2336

Package range

Axial

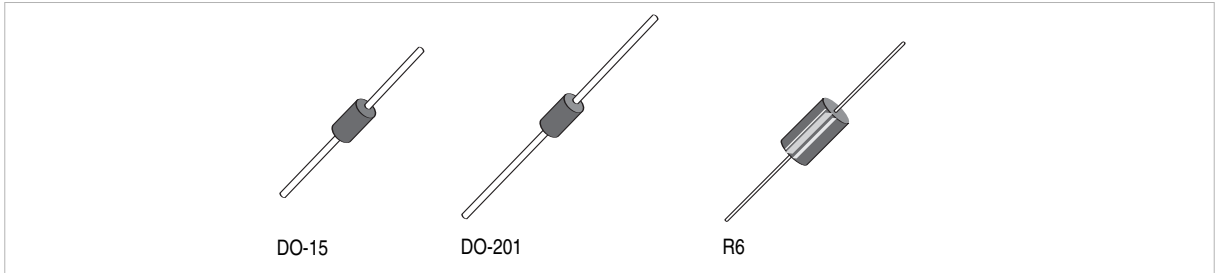

Through-hole

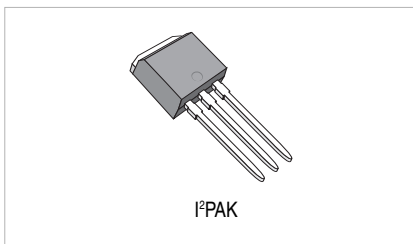

Through-hole

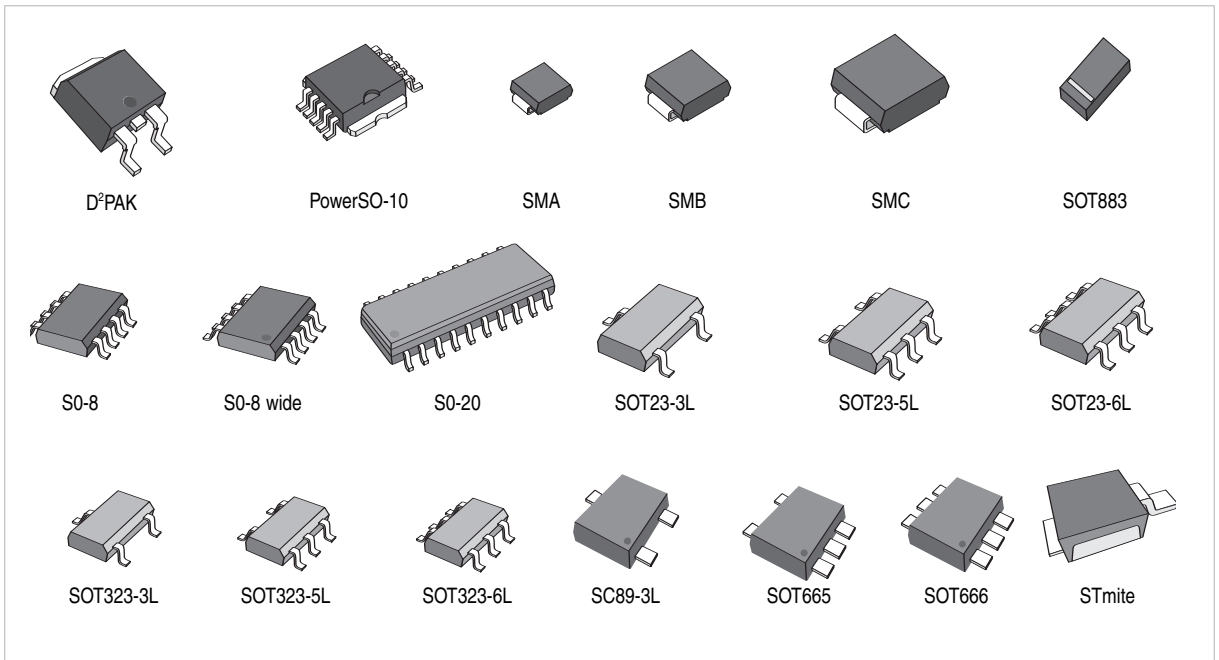

Chip scale

