



MIL-DTL-38999

## Features and Application Series III

## Features and Application

MIL-DTL-38999 Series III is the newest cylindrical connector designed for highest performance capabilities used in both general purpose and severe environment applications.

These connectors feature an improved “one-turn” coupling system, utilizing self-locking acme thread. Acme threads provide coupling durability, while thicker wall sections and greater coupling surface area improve strength and shock resistance. Blunting of the threads on both receptacle and plug coupling nut eliminates cross threading.

Elongated mounting holes permit the Series III Connector to intermount with various existing Mil-spec flange mounted receptacles, giving it a design replacement advantage.

Wall mount receptacle, jam nut receptacle and straight self-locking RFI plug are offered in 9 shell sizes and 54 insert arrangements utilizing M39029 contacts in sizes 22D, 20, 16, 12, 10 power and 8 twinax.

These connectors are available in wide range of shell materials and finishes. Aluminum shells are offered in electroless nickel and olive drab cadmium. Other finishes such as anodic and zinc cobalt are available upon request to commercial callouts only. In addition, we offer stainless steel shells (both passivated and electro-deposited nickel plated) with firewall inserts, and for highly corrosive environments, nickel-aluminum-bronze shells with standard environment-resisting inserts (commercial callouts only).

**MIL-STD-1560 Insert Arrangements** – Series III connectors use insert patterns and contacts common to Series I, making for an easy transition from bayonet to triple-lead, acme-thread, self-locking coupling.

**Metal-to-Metal Bottoming** – This feature precludes relative shell-to-shell motion, which may result in ordinary connector wear and moisture entrapment.

**Lockwiring Eliminated** – Self-locking quick coupling plug eliminates the need for lockwiring.

**Firewall Capability** - Stainless steel shells in both K and S firewall classes are offered.

**Universal I/R Tool** – A single, expendable plastic tool is used for both insertion and removal of contacts.

**Scoop-Proof Design** – Recessed pins in elongated shells minimize the possibility for contact damage. In a blind mating application, mating shells cannot “scoop” the pins, and cause a shorting or bending of contacts.

**Closed-Entry Socket Insert** – Hard dielectric socket face has lead-in chamfers for positive alignment of pins (even partially bent within pre-established limits) with sockets.

**Interfacial Pin Insert Seal** – Raised moisture barriers around each pin, which mate into lead-in chamfers of hard face socket insert, provide individual contact sealing. Interfacial seal is never touched by service tools.

**Elastomer Wire Sealing Grommet** – Sealing over a wide range of wire diameters is assured by a triple wire seal in each cavity at the rear of the connector.

**Superior Contact Stability** – Rear release crimp contact system features a stamped beryllium-copper retaining clip captivated by molded-in shoulders of each contact cavity in the insulator. A rear-inserted M81969 plastic tool expands the tines beyond the shoulder, releasing the contact.

**Metric Accessory Thread** – Metric thread results in additional wall thickness giving greater strength and shock resistance.

**Twinax Contacts** – Aero Electric is Qualified to make and supply M39029/90-529 and M39029/91-530 size 8 Twinax contacts used in 38999 III connectors. Please consult factory even when needing to buy just the contacts.



**MIL-DTL-38999**  
**Performance Specifications**  
**Series III**



## Performance Specifications

### Operating Temperature Range

Classes F, K, S and BZ\*: -65°C to +200°C (-85°F to +392°F)  
 Classes W, T, Z, BN\* and ZC\*: -65°C to +175°C (-85°F to +347°F)

### Material and Finish Data (Class)

- F – aluminum shell, electroless nickel finish
- K – stainless steel shell, passivated, firewall
- S – stainless steel shell, electrodeposited nickel, firewall
- T\* - aluminum shell, nickel flouorocarbon polymer finish
- W- aluminum shell, olive drab cadmium over nickel base
- Z\* - aluminum shell, zinc nickel finish
- BN\* -aluminum shell, black nickel finish
- BZ\* – aluminum nickel bronze shell, std insert
- ZC\* – aluminum shell, zinc cobalt finish

### Corrosion Resistance

Military Classes K, W and S, withstand 500-hour salt spray. Class F withstands 48-hour salt spray. Commerical RoHS Classes: BN\*, BZ\*, ZC\*. Consult factory for T and Z class availability.

### Durability

Minimum of 500 mating cycles.

### Fluid Resistance

Connectors resist specified immersions in MIL-PRF-7808, MIL-PRF-23699, MIL-PRF-5606, M2-V Chevron oil, Coolanol 25, MIL-DTL-83133 (JP-8), MIL-DTL-5624 (JP-4, JP-5), SAE-AMS1424 Type I, and other solvents and cleaning agents.

### Shielding Effectiveness

RFI and EMI attenuation at the specified frequencies meet the requirements of MIL-DTL-38999.

- RFI shielding effectiveness of mated connectors with RFI backshells is measured in a triaxial radio frequency leakage fixture.
- EMI shielding effectiveness is measured at the interface of mated connectors and tested by the mode-stirred technique specified in method 3008 of MIL-STD-1344.

### Voltage Rating

Service Rating	Suggested Operating Voltage		Test Voltage	Test Voltage	Test Voltage	Test Voltage
	(Sea Level)		Sea Level	50,000 Ft.	70,000 Ft.	100,000 Ft.
	AC (RMS)	DC	V RMS	V RMS	V RMS	V RMS
M	400	550	1300	550	350	200
N	300	450	1000	400	260	200
I	600	850	1800	600	400	200
II	900	1250	2300	800	500	200

**Note:** The establishment of electrical safety factors is left entirely to the designer, as he is in the best position to know

### Environmental Seal

Wired, mated connectors with specified accessories attached, shall meet the altitude-immersion test specified in MIL-DTL-38999.

### Shell-to-Shell Conductivity

Maximum potential drop shall not exceed:

- Classes F and S = 1.0 millivolt.
- Class W = 2.5 millivolts, Class K = 10.0 millivolts

### Shock and Vibration Requirements

Wired, mated connectors shall not be damaged, nor shall there be a current interruption longer than one microsecond when subjected to the following:

#### Shock

Pulse of approximate half sine wave of 300 G ± 15 percent magnitude with duration of 3 ± 1 milliseconds applied in three axes.

#### High Impact Shock

When mounted as specified in MIL-S-901, grade A, a drop of a 400 lb. Hammer from 1 foot, 3 feet and 5 feet applied to connector in three axes, totaling nine impacts.

#### Vibration

Wired and mated connectors withstand the following vibration levels:

- Sine vibration where connector samples with simulated accessory load are subjected to simple harmonic motion from 10 to 2,000 Hz in three mutually perpendicular axes, in 20 minute sweeps, for 12 hours in each axis at velocity of 254 mm/sec from 10-50 Hz, displacement of 1.5 mm from 50-140Hz and acceleration of 60G from 140-2,000Hz.
- Random Vibration per MIL-STD-1344, method 2005, test condition V at ambient temperature and test condition VI, Letter “J” at elevated temperature.

\* Not on QPL, can be supplied to Aero-Electric part number only.

exactly what peak voltages, switching currents, transients, etc., can be expected in a particular circuit.



**MIL-DTL-38999  
Part Number Development  
Series III**

**Military and Aero-Electric Part Number Development**

<b>Mil. Prefix</b>	<b>D38999/</b>	<b>20</b>	<b>W</b>	<b>C</b>	<b>35</b>	<b>P</b>	<b>N</b>	
<b>Aero Prefix</b>	<b>AE3</b>	<b>20</b>	<b>W</b>	<b>C</b>	<b>35</b>	<b>P</b>	<b>N</b>	<b>-340</b>
<b>Shell Type (Specification Sheet Number)</b>								
20 = Wall mount receptacle								
24 = Jam nut receptacle								
26 = Self-locking, RFI grounding plug								
<b>Class (Material &amp; Finish)</b>								
F = Aluminum shell, electroless nickel finish								
W = Aluminum shell, olive drab cadmium over electroless nickel base								
T = Aluminum shell, nickel flouorocarbon polymer finish (consult factory for availability)								
Z = Aluminum shell, zinc nickel finish (consult factory for availability)								
K = Stainless steel shell, passivated, with firewall insert								
S = Stainless steel shell, electrodeposited nickel, with firewall insert								
BN* = Aluminum shell, black nickel finish, (RoHS), (Aero p/n/ only)								
BZ* = Aluminum nickel bronze shell with standard insert (Aero p/n only)								
ZC* = Aluminum shell, zinc cobalt plating, (RoHS), (Aero p/n only)								
<b>Shell Size</b>								
A, B, C, D, E, F, G, H or J								
<b>Insert Arrangement</b>								
See pages 60 thru 62								
<b>Contact Style</b>								
P = Pin								
S = Socket								
A = Pin connector less pins (with intent to use non-std pin contacts)								
B = Socket connector less sockets (with intent to use non-std socket contacts)								
<b>Polarization (Keying)</b>								
N = Normal (Included in part number)								
A, B, C, D, or E								
<b>Modification (applies to Aero part numbers only)</b>								
01 = Less contacts (is not marked on the part)								
340 = Connector kitted with M85049/15-XXX								
341 = Connector kitted with M85049/38-XXX straight clamp								
342 = Connector kitted with M85049/39-XXX right angle clamp								
Consult factory for other modifications								

38999 S III

\* Not on QPL, can be supplied to Aero-Electric part number only.

**Note 1:** Each connector is furnished with contacts unless ordered less contacts (L/C) as follows: One spare contact for inserts requiring 2 through 26 of each contact and two spares for inserts with 27 or more contacts, and a minimum of one sealing plug up to 10% of the number contacts. Spare Coax and Twinax contacts are not supplied. One insertion/extraction tool for each contact size is also included.

**Note 2:** Proper part number marking has no "0" in front of single digit layout. Example: J D38999/20WB5SN. "N" for normal is included. In addition, J or JAN must be marked immediately in front of MIL part number.

**D38999/20**  
**Wall Mount Receptacle**  
**AE320**



**Triple Start Threaded Coupling, Crimp Removable, Rear Release, Scoop-Proof**

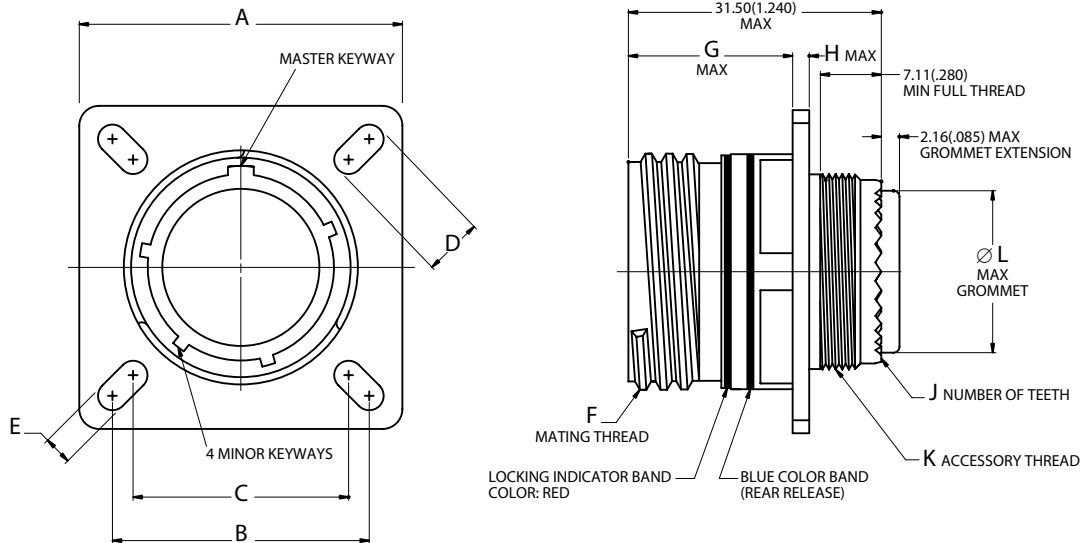

38999 S III

Page 46	Completed Part Number
Page 52	Contacts, Sealing Plugs and Tools
Pages 60–62	Insert Arrangements
Page 45	Performance Specifications
Pages 58, 59	Insert Availability and Contact Information
Page 50	Polarization

**Note 1:** “K” Accessory Thread for AE320 is same as AE326 (“D” Accessory Thread) on page 49.

**Note 2:** “F” Mating Thread for AE320 is same as AE326 (“E” Mating Thread) on page 49 except it is Class 2A.

**Note 3:** Maximum Grommet Extension for insert layouts incorporating size 8 and 10 contacts = **5.95(.234)**.

Shell Size	A		B		C		D		E		G		H		J	Ø L	
	±.012	±.30	(TP)		(TP)		±.008	±.20	±.008	±.20	Maximum		Maximum		No. of Teeth	Maximum	
	inch	mm	inch	mm	inch	mm	inch	mm	inch	mm	inch	mm	inch	mm		inch	mm
A	.937	23.80	.719	18.26	.594	15.09	.216	5.49	.128	3.25	.820	20.83	.098	2.50	12	.299	7.59
B	1.031	26.20	.812	20.62	.719	18.26	.194	4.93	.128	3.25	.820	20.83	.098	2.50	16	.427	10.85
C	1.126	28.60	.906	23.01	.812	20.62	.194	4.93	.128	3.25	.820	20.83	.098	2.50	20	.541	13.74
D	1.220	31.00	.969	24.61	.906	23.01	.173	4.39	.128	3.25	.820	20.83	.098	2.50	24	.666	16.92
E	1.311	33.30	1.062	26.97	.969	24.61	.194	4.93	.128	3.25	.820	20.83	.098	2.50	28	.791	20.09
F	1.437	36.50	1.156	29.36	1.062	26.97	.194	4.93	.128	3.25	.820	20.83	.098	2.50	32	.897	22.78
G	1.563	39.70	1.250	31.75	1.156	29.36	.194	4.93	.128	3.25	.790	20.07	.126	3.20	36	1.022	25.96
H	1.689	42.90	1.375	34.93	1.250	31.75	.242	6.15	.154	3.91	.790	20.07	.126	3.20	40	1.147	29.13
J	1.811	46.00	1.500	38.10	1.375	34.93	.242	6.15	.154	3.91	.790	20.07	.126	3.20	44	1.272	32.31

**Triple Start Threaded Coupling, Crimp Removable, Rear Release, Scoop-Proof**

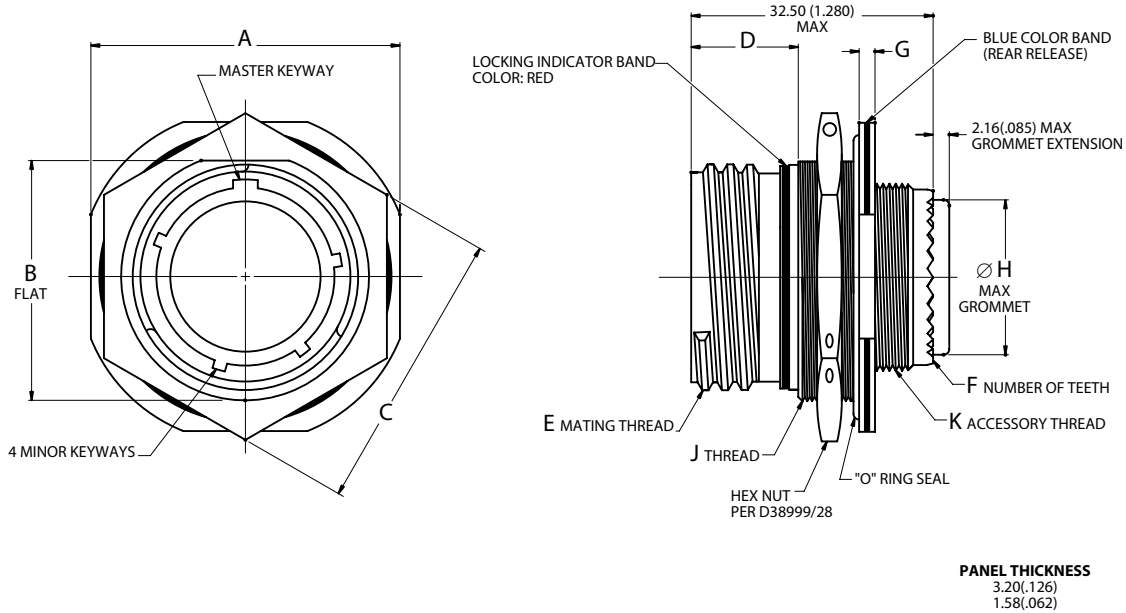

38999 S III

Page 46	Completed Part Number
Page 52	Contacts, Sealing Plugs and Tools
Pages 60–62	Insert Arrangements
Page 45	Performance Specifications
Pages 58, 59	Insert Availability and Contact Information
Page 50	Polarization

**Note 1:** “K” Accessory Thread for AE324 is same as AE326 (“D” Accessory Thread) on page 49.

**Note 2:** “E” Mating Thread for AE324 is same as AE326 (“E” Mating Thread) on page 49 except it is Class 2A.

**Note 3:** Maximum Grommet Extension for insert layouts incorporating size 8 and 10 contacts = **5.95(.234)**.

Shell Size	A		B		C		D		F	G		Ø H		J
	±.016	±.40	+0.04	+0.10			+0.024	+0.60	No. of Teeth	+0.035	+0.90			Jam Nut Thread
	inch	mm	inch	mm	inch	mm	inch	mm		inch	mm	inch	mm	0.100R
A	1.063	27.00	.651	16.53	.945/1.859	24.00/21.82	.555	14.10	12	.087	2.20	.299	7.59	M17x1-6g
B	1.252	31.80	.751	19.07	1.063/1.984	27.00/24.99	.555	14.10	16	.087	2.20	.427	10.85	M20x1-6g
C	1.374	34.90	.938	23.82	1.260/1.172	32.00/29.77	.555	14.10	20	.087	2.20	.541	13.74	M25x1-6g
D	1.500	38.10	1.062	26.97	1.417/1.296	36.00/32.91	.555	14.10	24	.087	2.20	.666	16.92	M28x1-6g
E	1.626	41.30	1.187	30.15	1.457/1.422	37.00/36.12	.555	14.10	28	.087	2.20	.791	20.09	M32x1-6g
F	1.811	46.00	1.312	33.32	1.614/1.546	41.00/39.26	.555	14.10	32	.118	3.00	.897	22.78	M35x1-6g
G	1.937	49.20	1.437	36.50	1.811/1.672	46.00/42.47	.555	14.10	36	.118	3.00	1.022	25.96	M38x1-6g
H	2.063	52.40	1.562	39.67	1.969/1.796	50.00/45.61	.555	14.10	40	.118	3.00	1.147	29.13	M41x1-6g
J	2.189	55.60	1.687	42.85	2.017/1.939	51.23/49.25	.555	14.10	44	.118	3.00	1.272	32.31	M44x1-6g

**D38999/26**  
**Self-Locking, RFI Grounding Plug**  
**AE326**



**Triple Start Threaded Coupling, Crimp Removable, Rear Release, Scoop-Proof**

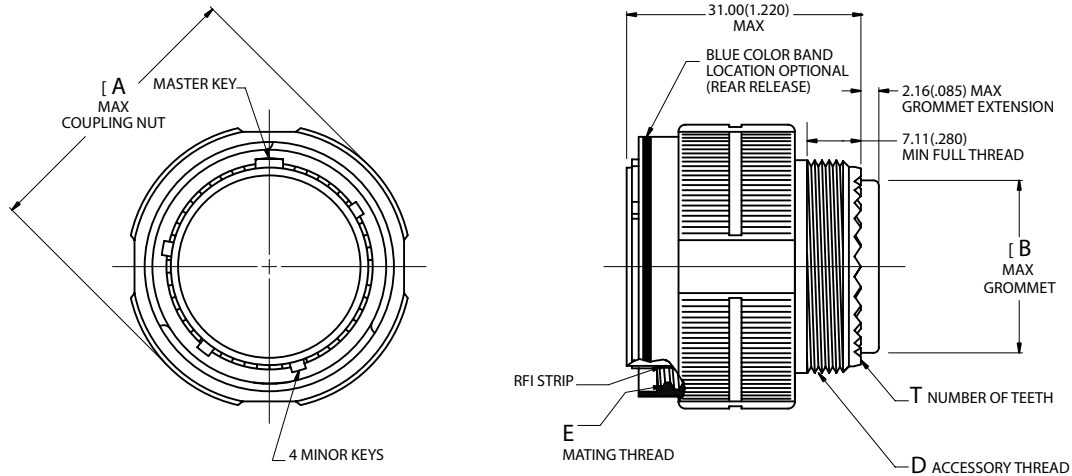

38999 S III

Page 46	Completed Part Number
Page 52	Contacts, Sealing Plugs and Tools
Pages 60–62	Insert Arrangements
Page 45	Performance Specifications
Pages 58, 59	Insert Availability and Contact Information
Page 50	Polarization

**Note :** Maximum Grommet Extension for insert layouts incorporating size 8 and 10 contacts = **5.95(.234)**.

Shell Size	Ø A		Ø B		D	E	T
	Maximum		Maximum		Accessory Thread Metric	Mating Thread Class 2B	No. of Teeth
	inch	mm	inch	mm			
A	.858	21.80	.299	7.59	M12x1.0-6g 0.100R	.6250-0.1P-0.3L	12
B	.984	25.00	.427	10.85	M15x1.0-6g 0.100R	.7500-0.1P-0.3L	16
C	1.157	29.40	.541	13.74	M18x1.0-6g 0.100R	.8750-0.1P-0.3L	20
D	1.280	32.50	.666	16.92	M22x1.0-6g 0.100R	1.0000-0.1P-0.3L	24
E	1.406	35.70	.791	20.09	M25x1.0-6g 0.100R	1.1875-0.1P-0.3L	28
F	1.516	38.50	.897	22.78	M28x1.0-6g 0.100R	1.2500-0.1P-0.3L	32
G	1.642	41.70	1.022	25.96	M31x1.0-6g 0.100R	1.3750-0.1P-0.3L	36
H	1.768	44.90	1.147	29.13	M34x1.0-6g 0.100R	1.5000-0.1P-0.3L	40
J	1.890	48.00	1.272	32.31	M37x1.0-6g 0.100R	1.6250-0.1P-0.3L	44



### Keying Positions

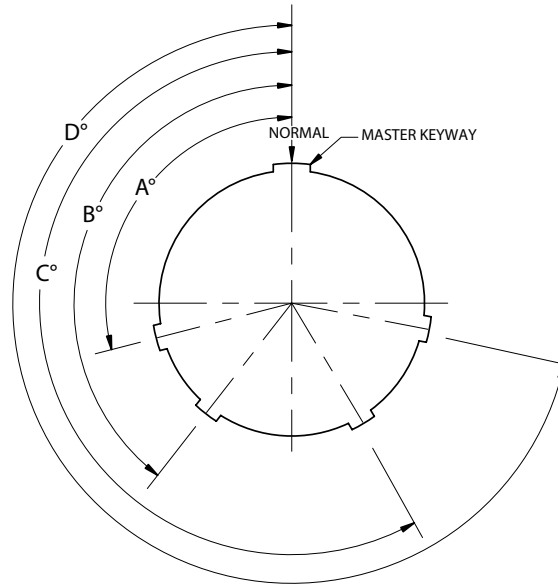

38999 S III

**Notes:**

1. Mating face of receptacle shown (plug is opposite).
2. All minor keyways (keys) are rotated to provide shell polarization while master keyway (key) remains fixed as shown.
3. The angles for a given connector are the same whether it contains pin or socket inserts.
4. Insert arrangement does not rotate relative to the master keyway (key).

Shell Size	Key/Keyway	Key/Keyway Positions			
	Identification Letter	BSC			
		A°	B°	C°	D°
A (9)	N	105	140	215	265
	A	102	132	248	320
	B	80	118	230	312
	C	35	140	205	275
	D	64	155	234	304
B (11) C (13) D (15)	E	91	131	197	240
	N	95	141	208	236
	A	113	156	182	292
	B	90	145	195	252
	C	53	156	220	255
E (17) F (19) G (21) H (23) J (25)	D	119	146	176	298
	E	51	141	184	242
	N	80	142	196	293
	A	135	170	200	310
	B	49	169	200	244
	C	66	140	200	257
	D	62	145	180	280
	E	79	153	197	272

# MIL-DTL-38999 Series III Flange and Jam Nut Receptacle Panel Cutouts



## Panel Cutouts

FLANGE MOUNT

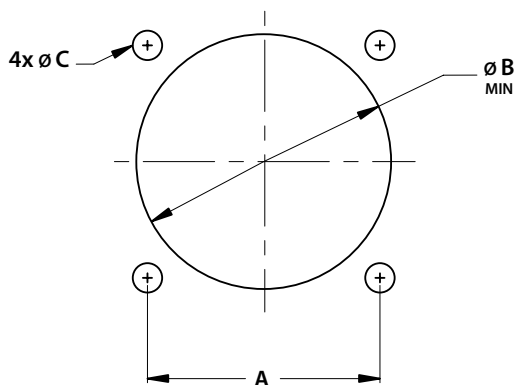

JAM NUT MOUNT

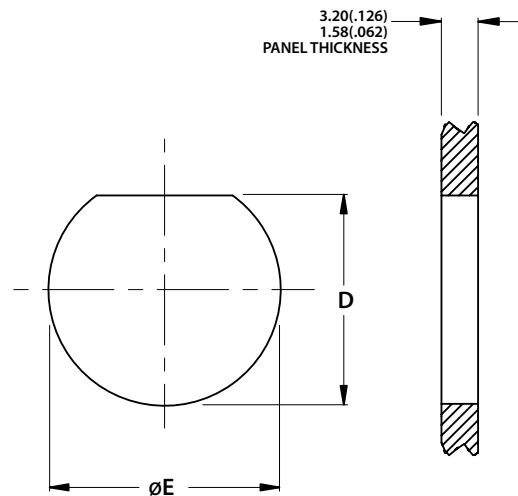

**Note:** Diameter B cutout dimensions are listed separately for back and front of panel mounting.

Shell Size	A		Ø B		Ø B		Ø C		D		Ø E	
	(TP)		For Back Mounting Minimum		For Front Mounting Minimum		±.005	±.13	+ .000*	+ .00*	+ .010	+ .25
	inch	mm	inch	mm	inch	mm	inch	mm	inch	mm	inch	mm
A (9)	.719	18.26	.656	16.66	.516	13.11	.128	3.25	.657*	16.70*	.700	17.78
B (11)	.812	20.62	.796	20.22	.625	15.88	.128	3.25	.771	19.59	.825	20.96
C (13)	.906	23.01	.922	23.42	.750	19.05	.128	3.25	.955	24.26	1.010	25.65
D (15)	.969	24.61	1.047	26.59	.906	23.01	.128	3.25	1.085	27.56	1.135	28.83
E (17)	1.062	26.97	1.219	30.96	1.016	25.81	.128	3.25	1.210	30.73	1.260	32.01
F (19)	1.156	29.36	1.297	32.94	1.141	28.98	.128	3.25	1.335	33.91	1.385	35.18
G (21)	1.250	31.75	1.422	36.12	1.266	32.16	.128	3.25	1.460	37.08	1.510	38.35
H (23)	1.375	34.93	1.547	39.29	1.375	34.93	.154	3.91	1.585	40.26	1.635	41.53
J (25)	1.500	38.10	1.672	42.47	1.484	37.69	.154	3.91	1.710	43.43	1.760	44.70

\* Tolerance ± .10mm (±.004")





**MIL-DTL-38999**  
**Contacts, Tools and Seal Plugs**  
**Series III**

**Contacts, Plastic Insertion/Removal Tools and Seal Plugs**

Contact Size	Application	Pin Contacts	Socket Contacts	Seal Plugs	Insertion/Removal Tools
	Type	Military No.	Military No.	Military No.	Military No.
22D	Power/Signal	M39029/58-360	M39029/56-348	MS27488-22-1	M81969/14-01
20	Power/Signal	M39029/58-363	M39029/56-351	MS27488-20-1	M81969/14-10
16	Power/Signal	M39029/58-364	M39029/56-352	MS27488-16-1	M81969/14-03
12	Power/Signal	M39029/58-365	M39029/56-353	MS27488-12-1	M81969/14-04
12 Coax	Coax	M39029/28-211	M39029/75-416		
12 Coax	Coax	M39029/102-558	M39029/103-559		
10 (Power)	Power	M39029/58-528	M39029/56-527	M85049/81-10***	M81969/14-05
8 Coax	Coax	M39029/60-367	M39029/59-366	MS27488-8-1	M81969/14-06
8 Twinax****	Twinax	M39029/90-529	M39029/91-530	MS27488-8-1	M81969/14-12

**Crimping and Metal Insertion/Extraction Tools**

Contact Size/Type	Crimp Tool	Positioner	Positioner	Insertion Tool	Extraction Tool
	Military No.	For Pin Contacts Military No.	For Socket Contacts Military No.	Metal Military No.	Metal Military No.
22D	M22520/2-01	M22520/2-09	M22520/2-07	M81969/8-01	M81969/8-02
20	M22520/1-01	M22520/1-04	M22520/1-04	M81969/8-05	M81969/8-06
	M22520/2-01	M22520/2-10	M22520/2-10		
16	M22520/1-01	M22520/1-04	M22520/1-04	M81969/8-07	M81969/8-08
12	M22520/1-01	M22520/1-04	M22520/1-04	M81969/8-09	M81969/8-10
12 Coax Inner	M22520/2-01	M22520/2-34	M22520/2-34		
12 Coax Outer	M22520/31-01	M22520/31-02	M22520/31-02		
10 ( Power)	—	—	—	M81969/8-11	M81969/8-12
8 Coax Inner	M22520/2-01	M22520/2-31	M22520/2-31	M81969/8-13**	M81969/8-14
8 Coax Outer	M22520/5-01	M22520/5-05 Die Closure B	M22520/5-05 Die Closure B		
8 Twinax Center	M22520/2-01	M22520/2-37	M22520/2-37	—	—
8 Twinax Outer & Intermediate	M22520/5-01	M22520/5-200	M22520/5-200		

38999 S III

**Contact and Wire Data**

Contact Size	Test Current*	Voltage*	Crimp Well Data			Wire Range		Finished Wire Ø Range			
	DC Test	Max. Drop	Well Dia.	Minimum Well Dept		AWG	mm <sup>2</sup>	Minimum		Maximum	
	Amps	Millivolts	inch	inch	mm			inch	mm	inch	mm
22D	5.0	73	.0345 ±.0010	.141	3.58	28-22	.08-.33	.030	.76	.054	1.37
20	7.5	55	.047 ±.001	.209	5.31	24-20	.20-.52	.040	1.02	.083	2.11
16	13.0	49	.067 ±.001	.209	5.31	20-16	.52-1.31	.065	1.65	.109	2.77
12	23.0	42	.100 ±.002	.209	5.31	14-12	2.08-3.31	.097	2.46	.142	3.61
10	33.0	33	.137 ±.003	.355	9.02	12-10†	3.31-5.26	.135	3.42	.162	4.12

† MS3348 bushing required with 12 gauge wire.

\* When tested with silver-plated wire.

\*\* Insertion tool is not required.

\*\*\* Dummy contact, used in lieu of unwired contact and seal plug.

\*\*\*\* Aero Electric is Qualified for Twinax contacts, consult factory for a quote.

**Note:** Size 8 coax contacts are used with M17/095-RG180 cable, while size 8 Twinax contacts are used with M17/176-00002 cable.



## Contact Installation Instructions

### Crimping Contacts

1. Select the appropriate crimp tool and ensure that the proper crimp head positioner is used.
2. Cycle the tool to be sure the indentors are open.
3. Determine the correct selector setting for the wire size from the data plate on the positioner (turret head assembly) and set the selector knob on the crimp tool to match.
4. Place the contact, mating end first, into the tool.
5. Insert the stripped wire into the hollow end of the contact. Be sure the wire is inserted as far as it will go.
6. Close the tool completely to crimp. Unless the tool is closed completely, the tool will not release the contact.
7. Remove the crimped contact from the tool. Check the inspection hole to verify that the wire is fully inserted.

### Insertion of Contacts

1. Before inserting the contacts, unscrew the accessories (clamps, backshells or adapters) from rear of plug or receptacle. Slide the hardware over the wire bundle in the proper order for reassembly after all the contacts are inserted.
2. To assist insertion of contacts, lubricate insulator (grommet) cavities with isopropyl alcohol. Alcohol will evaporate and will not leave a conductive film. **Caution: Never use any lubricant other than isopropyl alcohol.**

3. Place the correct insertion tool on the contact so that the wire runs along the groove in the tool. (Tool tip will butt against the shoulder.) Hold the plug or receptacle body firmly.
4. Beginning with a center cavity, insert the contact into the insulator with a slow, even pressure until the contact snaps into position. Make sure the contact and tool are held perpendicular to the face of the insert during the contact installation or the grommet could be damaged.
- 4.1 If contacts are not inserted all the way prior to removing insertion tool, do not try to reinsert the insertion tool. Instead, remove the contact and try again; otherwise reinserting the insertion tool may damage the inside of the contact cavity.
5. Remove tool and check the face of the connector for proper contact installation. Proper installation may also be checked by pulling back lightly on the wire to make sure the contact is properly seated.

### Completion

After all the cavities have been filled, slide the hardware back into position on the connector and tighten.

### Extraction of Contacts (Rework)

1. Slide the hardware back over the wire bundle.
2. Select the appropriate tool. Place the wire into the extraction tool of the pin or socket.
3. Slowly slide the extraction tool down wire into the contact cavities until the tool tip bottoms against the contact shoulder, expanding the clip retaining tines. Hold the wire firmly in the tool and pull the wired contact and tool straight out of the rear of the insulator.

Size	Pin Contact	Socket Contact	Basic Crimp Tool	Pin Positioner	Socket Positioner	Insertion/Removal Tool
22D	M39029/58-360	M39029/56-348	M22520/2-01	M22520/2-09	M22520/07	M81969/14-01
20	M39029/58-363	M39029/56-351	M22520/1-01	M22520/1-04 Red	M22520/1-04 red	M81969/14-10
			M22520/2-01	M22520/2-10	M22520/2-10	
16	M39029/58-364	M39029/56-352	M22520/1-01	M22520/1-04 Blue	M22520/1-04 Blue	M81969/14-03
12	M39029/58-365	M39029/56-353	M22520/1-01	M22520/1-04 Yellow	M22520/1-04 Yellow	M81969/14-04
10	M39029/58-528	M39029/56-527	*	*	*	M81969/14-05

For Coax and Twinax contacts refer to instructions that are supplied with contacts.

\* Contact Daniels Manufacturing for crimp tool/positioner.



**Dummy Stowage Receptacle  
Part Number Configuration**

<b>MIL. Prefix</b>	<b>D38999/</b>	<b>22</b>	<b>C</b>	<b>W</b>
<b>Aero Prefix</b>	<b>AE3</b>	<b>22</b>	<b>C</b>	<b>W</b>
<b>Shell Type</b>				
22 = receptacle, dummy stowage, threaded				
<b>Shell Size**</b>				
A, B, C, D, E, F, G, H or J				
<b>Material Finish</b>				
W = Aluminum Shell, Olive Drab Cadmium Finish				
F = Aluminum, Electroless Nickel Finish				
K = Stainless Steel, Passivated				
S = Stainless Steel, Electrodeposited Nickel				
BN* = Aluminum Shell, Black Nickel Finish (Aero p/n only)				

\* Not on QPL, can be supplied to Aero-Electric part number only.

\*\* Shell size code A is for use with plugs with mating key polarizations "C", "E" or "N".  
Shell size code AA is for use with plugs with mating key polarizations "A", "B" or "D".

38999 S III

**Protective Metal Caps  
Part Number Configuration**

<b>MIL. Prefix</b>	<b>D38999/</b>	<b>32</b>	<b>W</b>	<b>11</b>	<b>R</b>
<b>Aero Prefix</b>	<b>AE3</b>	<b>32</b>	<b>W-</b>	<b>11</b>	<b>R</b>
<b>Shell Type</b>					
32 = cover, protective, plug					
33 = cover, protective, receptacle					
<b>Material Finish</b>					
W = Aluminum Shell, Olive Drab Cadmium Finish					
F = Aluminum, Electroless Nickel Finish					
K = Stainless Steel, Passivated					
S = Stainless Steel, Electrodeposited Nickel					
BN* = Aluminum Shell, Black Nickel Finish (Aero p/n only)					
<b>Shell Size</b>					
9,11,13, 15, 17, 19, 21, 23, 25					
<b>Style</b>					
R = Wire Rope Assembly					
N = Wire Rope/Ring Assembly					

\* Not on QPL, can be supplied to Aero-Electric part number only.

**D38999/22**  
**Dummy Storage Receptacle**  
**AE322**



**AE322 Threaded Dummy Storage Receptacle**

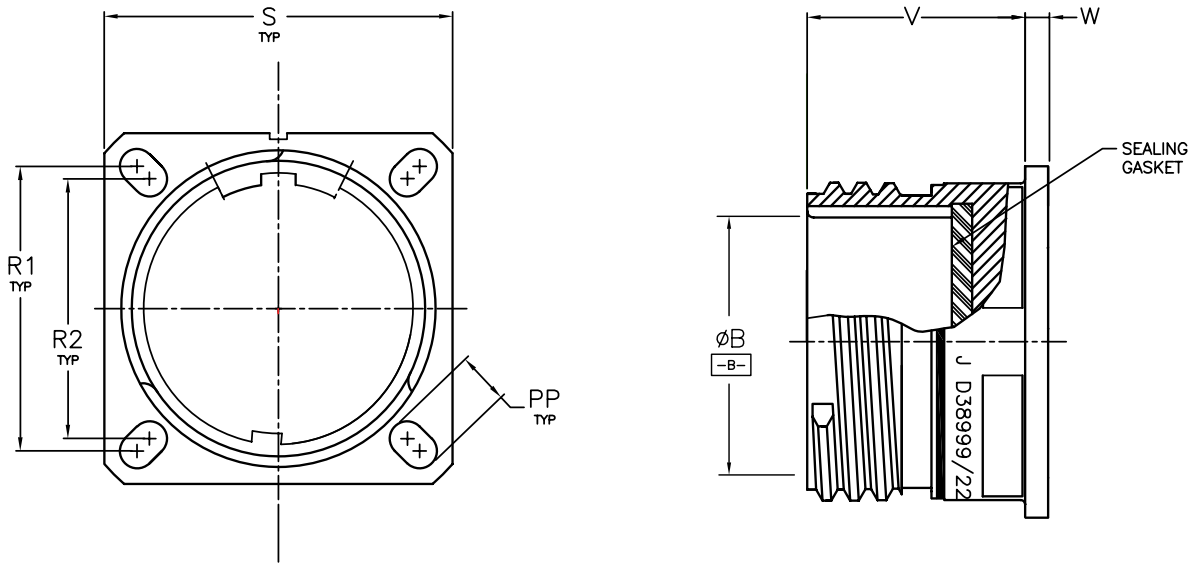

38999 S III

SHELL SIZE	SHELL SIZE CODE	Ø B		PP		R1		R2		S		V		W	
		MM	INCH	MM ±.20	INCH ±.008	MM	INCH	MM	INCH	MM ±.3	INCH ±.012	MM ±.00 ±.13	INCH ±.000 ±.005	MM ±.3	INCH ±.012
9	A	12.63 12.47	.497 .491	5.49	.216	18.26	.719	15.09	.594	23.8	.937	20.83	.820	2.5	.098
11	B	15.88 15.73	.625 .619	4.93	.194	20.62	.812	18.26	.719	26.2	1.031	20.83	.820	2.5	.098
13	C	19.63 19.49	.773 .767	4.93	.194	23.01	.906	20.62	.812	28.6	1.126	20.83	.820	2.5	.098
15	D	22.84 22.69	.899 .893	4.39	.173	24.61	.969	23.01	.906	31.0	1.220	20.83	.820	2.5	.098
17	E	25.99 25.84	1.023 1.017	4.93	.194	26.97	1.062	24.61	.969	33.3	1.311	20.83	.820	2.5	.098
19	F	28.63 28.48	1.127 1.121	4.93	.194	29.36	1.156	26.97	1.062	36.5	1.437	20.83	.820	2.5	.098
21	G	31.83 31.68	1.253 1.247	4.93	.194	31.75	1.250	29.36	1.156	39.7	1.563	20.07	.790	3.2	.126
23	H	35.03 34.88	1.379 1.373	6.15	.242	34.93	1.375	31.75	1.250	42.9	1.689	20.07	.790	3.2	.126
25	J	38.18 38.03	1.503 1.497	6.15	.242	38.10	1.500	34.93	1.375	46.0	1.811	20.07	.790	3.2	.126



**Protective Cover Plug**

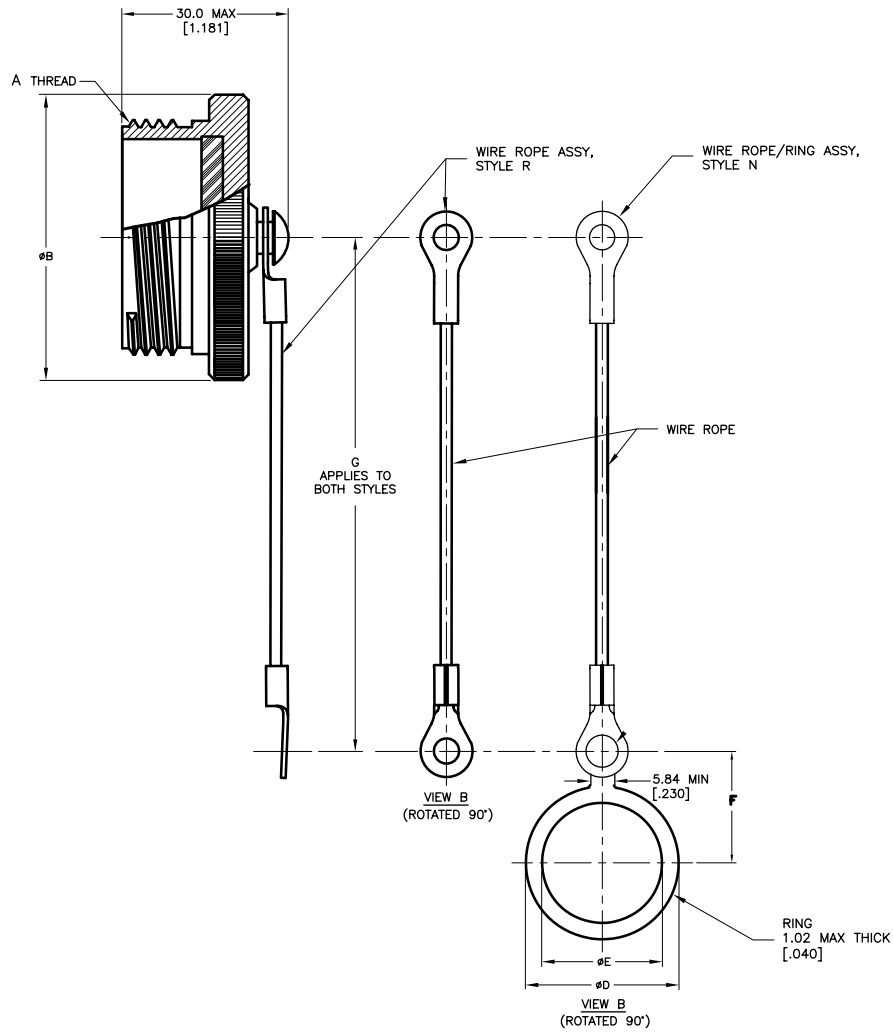

38999 S III

SHELL SIZE	A THREAD CLASS 2A TRIPLE START	Ø B MAX		Ø D MAX		Ø E MAX		G	
		INCH	MM	INCH	MM	INCH	MM	INCH +.512 -.276	MM +13.0 -7.0
9	.6250-0.1P-0.3L	.906	23.0	.945	24.0	.512	13.0	5.000	127.00
11	.7500-0.1P-.03L	1.024	26.0	1.063	27.0	.709	18.0	5.000	127.00
13	.8750-0.1P-.03L	1.221	31.0	1.181	30.0	.787	20.0	5.000	127.00
15	1.0000-0.1P-.03L	1.299	33.0	1.221	31.0	.906	23.0	5.000	127.00
17	1.1875-0.1P-.03L	1.457	37.0	1.457	37.0	1.024	26.0	5.000	127.00
19	1.2500-0.1P-.03L	1.575	40.0	1.575	40.0	1.142	29.0	5.000	127.00
21	1.3750-0.1P-.03L	1.732	44.0	1.732	44.0	1.260	32.0	5.000	127.00
23	1.5000-0.1P-.03L	1.811	46.0	1.811	46.0	1.339	34.0	5.000	127.00
25	1.6250-0.1P-.03L	1.969	50.0	1.929	49.0	1.535	39.0	5.000	127.00

**D38999/33**  
**Protective Cover, Receptacle**  
**AE333**



**Protective Cover Receptacle**

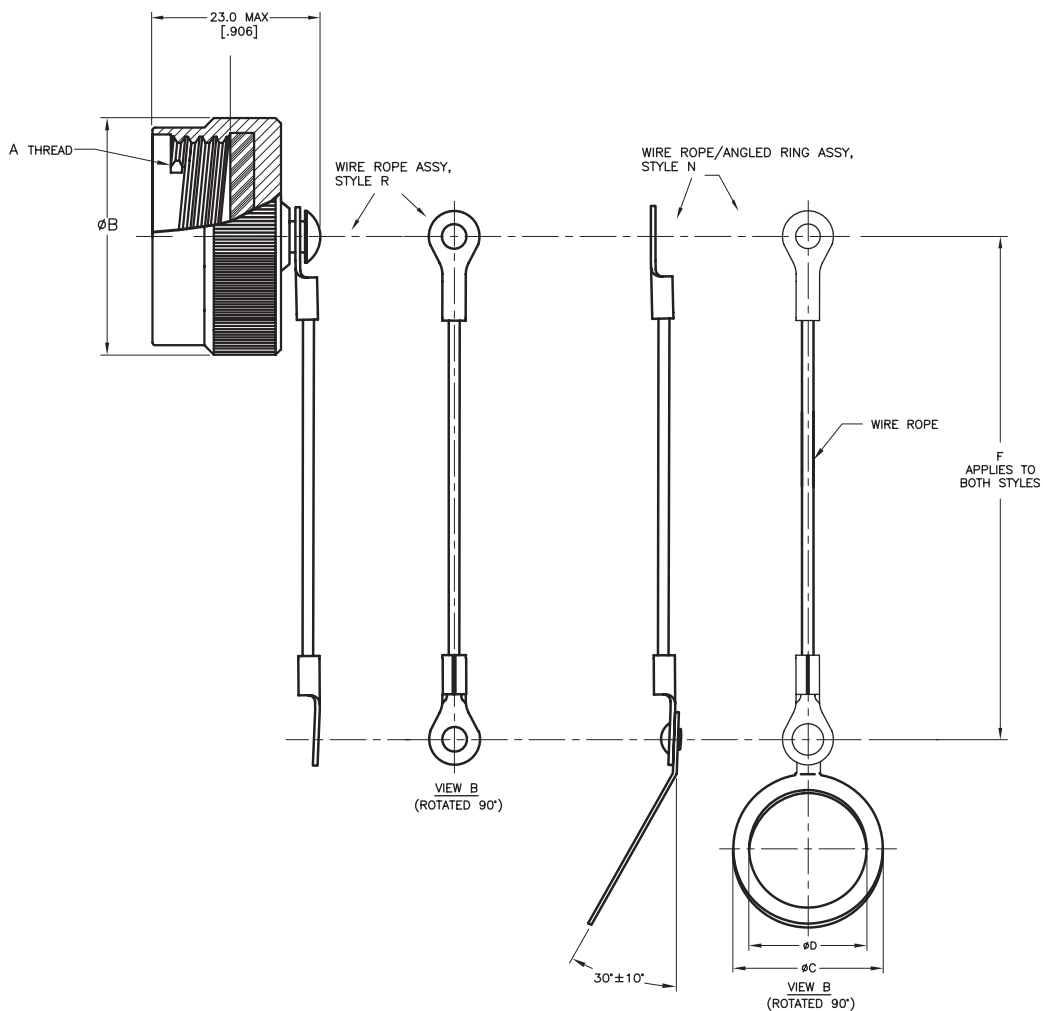

38999 S III

SHELL SIZE	A THREAD CLASS 2B TRIPLE START	Ø B MAX		Ø C MAX		Ø D MIN		F	
		INCH	MM	INCH	MM	INCH	MM	INCH	MM
9	.6250-0.1P-0.3L	.906	23.0	1.063	27.0	.695	17.64	5.000	127.00
11	.7500-0.1P-0.3L	1.102	28.0	1.260	32.0	.865	21.97	5.000	127.00
133	.8750-0.1P-0.3L	1.221	31.0	1.457	37.0	.989	25.12	5.000	127.00
15	1.0000-0.1P-0.3L	1.260	32.0	1.575	40.0	1.178	29.92	5.000	127.00
17	1.1875-0.1P-0.3L	1.457	37.0	1.732	44.0	1.260	32.00	5.000	127.00
19	1.2500-0.1P-0.3L	1.535	39.0	1.811	46.0	1.428	36.27	5.000	127.00
21	1.3750-0.1P-0.3L	1.654	42.0	1.929	49.0	1.506	38.25	5.000	127.00
23	1.5000-0.1P-0.3L	1.772	45.0	2.126	54.0	1.678	42.62	5.000	127.00
25	1.6250-0.1P-0.3L	1.929	49.0	2.205	56.0	1.750	44.45	5.000	127.00





**MIL-DTL-38999 Series III  
Insert Availability and Contact Information  
per MIL-STD-1560**

**Insert Availability and Contact Information**

Insert Arrangement	Aero-Electric		Service	Total	Quantity of Contacts					
	Status			No. of	(by Size)					
Series III	QPL'd	Tooled	Rating	Contacts	22D	20	16	12	10	8
A35	Yes	Yes	M	6	6					
A98	Yes	Yes	I	3		3				
B2	Yes	Yes	I	2			2			
B4	Yes	Yes	I	4		4				
B5	Yes	Yes	I	5		5				
B35	Yes	Yes	M	13	13					
B98	Yes	Yes	I	6		6				
B99	Yes	Yes	I	7		7				
C4	Yes	Yes	I	4			4			
C8	Yes	Yes	I	8		8				
C35	Yes	Yes	M	22	22					
C98	Yes	Yes	I	10		10				
D5	Yes	Yes	II	5			5			
D15	Yes	Yes	I	15		14	1			
D18	Yes	Yes	I	18		18				
D19	Yes	Yes	I	19		19				
D35	Yes	Yes	M	37	37					
D97	Yes	Yes	I	12		8	4			
E6	Yes	Yes	I	6				6		
E8	Yes	Yes	II	8			8			
E26	Yes	Yes	I	26		26				
E35	Yes	Yes	M	55	55					
E99	Yes	Yes	I	23		21	2			
F11	Yes	Yes	II	11			11			
F28	Yes	Yes	I	28		26	2			
F30	Yes	Yes	I	30		29	1			
F32	Yes	Yes	I	32		32				
F35	Yes	Yes	M	66	66					

See next page for Shell Sizes G thru J layouts.

38999 S III

**MIL-DTL-38999 Series III**  
**Insert Availability and Contact Information**  
**per MIL-STD-1560**



**Insert Availability and Contact Information (continued)**

Insert Arrangement	Aero-Electric		Service	Total	Quantity of Contacts					
	Status			No. of	(by Size)					
Series III	QPL'd	Tooled	Rating	Contacts	22D	20	16	12	10	8
G11	Yes	Yes	I	11				11		
G16	Yes	Yes	II	16			16			
G35	Yes	Yes	M	79	79					
G39	Yes	Yes	I	39		37	2			
G41	Yes	Yes	I	41		41				
G48**	N/A	Yes	I	4						4 (Power)
G75	Yes	Yes	Twinax	4						4 (Twinax)
H21	Yes	Yes	II	21			21			
H32	Yes	Yes	I	32		32				
H35	Yes	Yes	M	100	100					
H53	Yes	Yes	I	53		53				
H55	Yes	Yes	I	55		55				
J4	Yes	Yes	I	56		48	8			
J8	Yes	Yes	Twinax	8						8 (Twinax)
J11	Yes	Yes	N	11		2			9	
J19	Yes	Yes	I	19				19		
J20	Yes	Yes	N, Coax, Twinax	30		10	13	4 (Coax)		3 (Twinax)
J24	Yes	Yes	I	24			12	12		
J29	Yes	Yes	I	29			29			
J35	Yes	Yes	M	128	128					
J43	Yes	Yes	I	43		23	20			
J46****	Yes	Yes	I, Coax	46		40	4			2 (Coax)
J61	Yes	Yes	I	61		61				
J90	Yes	Yes	I, Twinax	46		40	4			2 (Twinax)

38999 S III

\*\* G48 layout is not to MIL-STD-1560. It is tooled and intended for comm'l use only.

\*\*\* Not approved for new design. Pictorial is shown on page 62.

**Note 1:** J20P uses 4 size 12 coax contacts as follows: 2 ea M39029/28-211 and 2 ea of M39029/102-558; J20S uses 4 size 12 coax contacts as follows: 2 ea M39029/75-416 and 2 ea of M39029/103-559.

**Note 2:** Layouts (G75, J8, J20, J46 and J90) that take twinax or coax contacts should not be used for firewall applications (Classes K & S) in Series III.

**Note 3:** H and J contact styles (in lieu of P & S) are meant for Composite (classes J & M) Series III only. Aluminum (classes A, B, F & W) and Firewall (classes K & S) are rated for 500 cycles regardless what contacts are used.



**Insert Arrangements Views**



A35,  
6 # 22D, M



A98,  
3 # 20, I

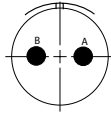

B2,  
2 # 16, I

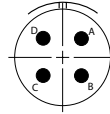

B4,  
4 # 20, I

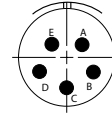

B5,  
5 # 20, I

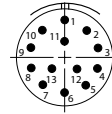

B35,  
13 # 22D, M

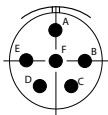

B98,  
6 # 20, I

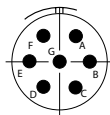

B99,  
7 # 20, I

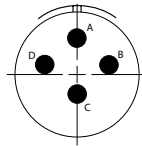

C4,  
4 # 16, I

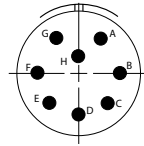

C8,  
8 # 20, I

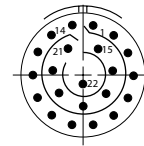

C35,  
22 # 22D, M

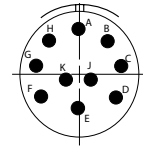

C98,  
10 # 20, I

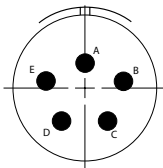

D5,  
5 # 16, II

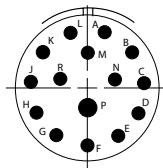

D15,  
1 # 16, 14 # 20, I

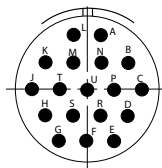

D18,  
18 # 20, I

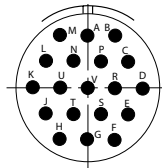

D19,  
19 # 20, I

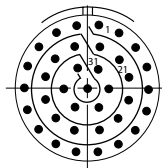

D35,  
37 # 22D, M

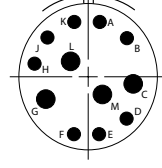

D97,  
4 # 16, 8 # 20, I

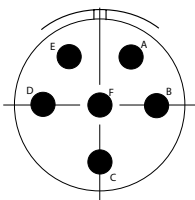

E6,  
6 # 12, I

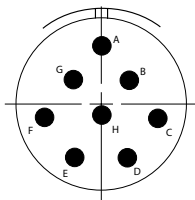

E8,  
8 # 16, II

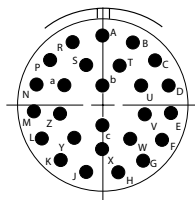

E26,  
26 # 20, I

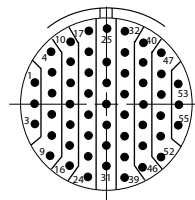

E35,  
55 # 22D, M

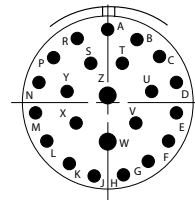

E99,  
2 # 16, 21 # 20, I

38999 S III

**MIL-STD-1560**  
**Insert Arrangements (Pin Front View)**  
**for MIL-DTL-38999 Series III Connectors**



**Insert Arrangements Views**

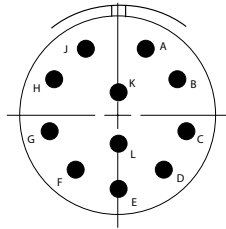

F11,  
11 # 16, II

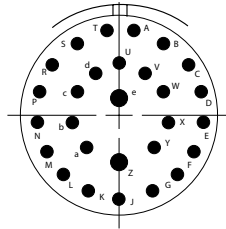

F28,  
2 # 16, 26 # 20, I

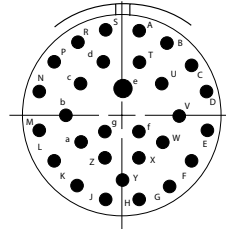

F30,  
1 # 16, 29 # 20, I

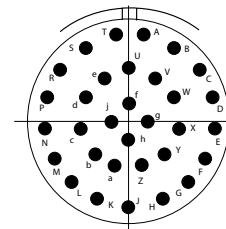

F32,  
32 # 20, I

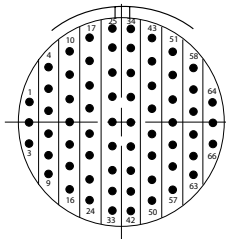

F35,  
66 # 22D, M

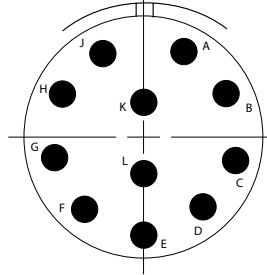

G11,  
11 # 12, I

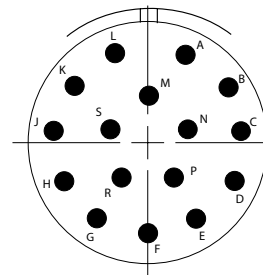

G16,  
16 # 16, II

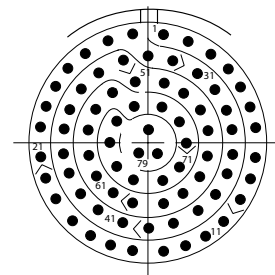

G35,  
79 # 22D, M

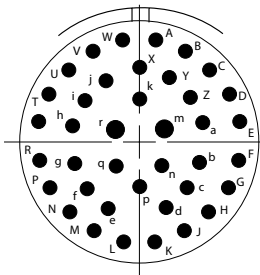

G39,  
2 # 16, 37 # 20, I

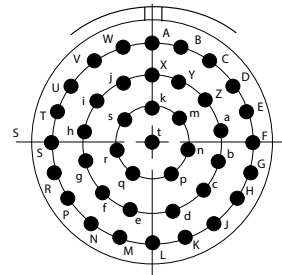

G41,  
41 # 20, I

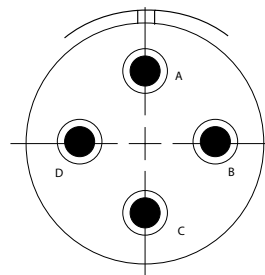

G48\*\*,  
4 # 8 Power, I

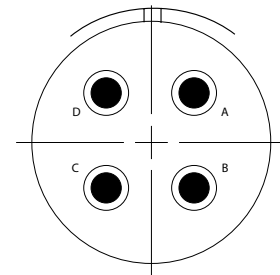

G75,  
4 # 8 Twinax, Twinax

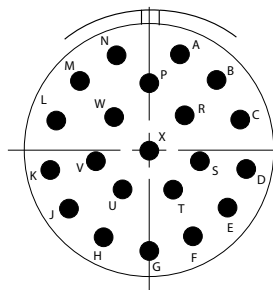

H21,  
21 # 16, II

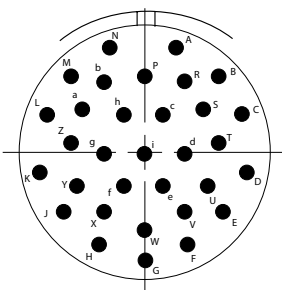

H32,  
32 # 20, I

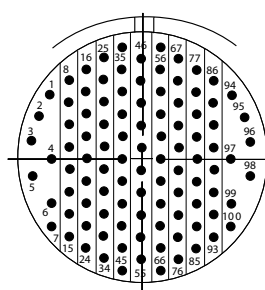

H35,  
100 # 22D, M

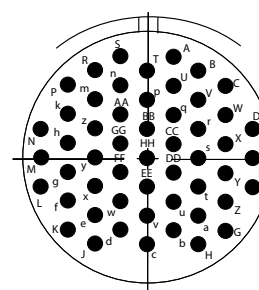

H53,  
53 # 20, I

\* Inactive for new design.

\*\* Not MIL-STD-1560 layout (not QPL'd.).

### Insert Arrangements Views

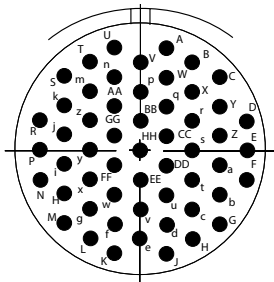

H55,  
55 # 20, I

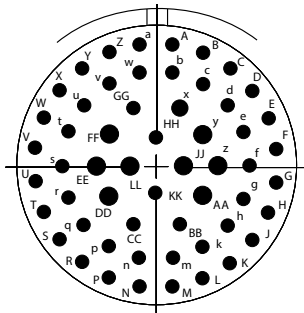

J4,  
8 # 16, 48 # 20, I

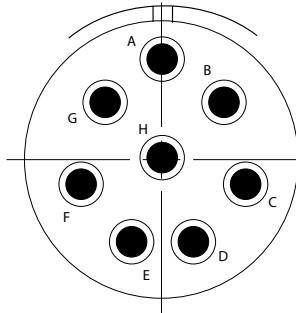

J8  
8 # 8 Twinax,  
Twinax

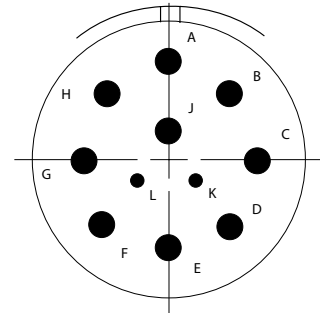

J11  
9 # 10, 2 # 20,  
N

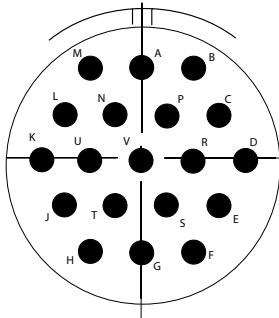

J19,  
19 # 12, I

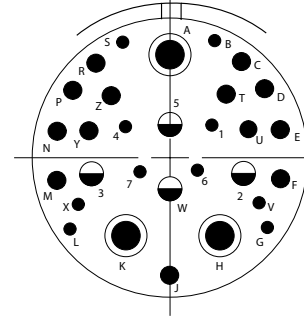

J20  
10 # 20, 13 # 16, 4 # 12, 3 # 8 Twinax,  
N / Coax / Twinax

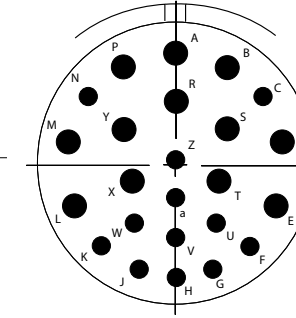

J24,  
12 # 12, 12 # 16, I

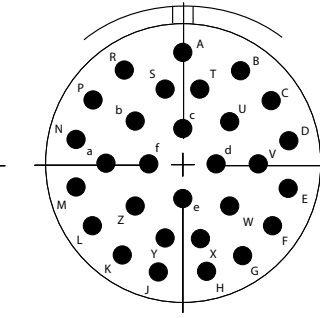

J29,  
29 # 16, I

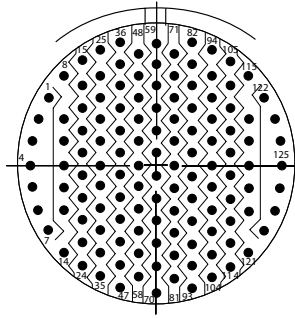

J35,  
128 # 22D, M

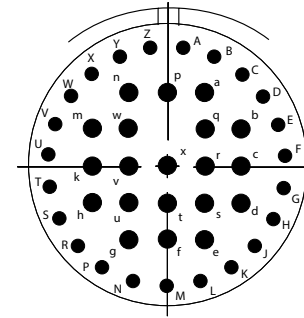

J43,  
20 # 16, 23 # 20, I

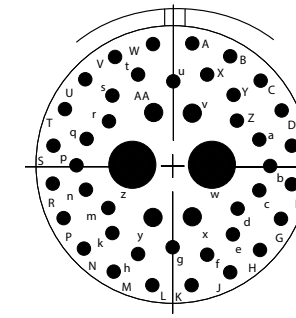

J46,  
40 # 20, 4 # 16, 2 # 8 Coax, I / Coax

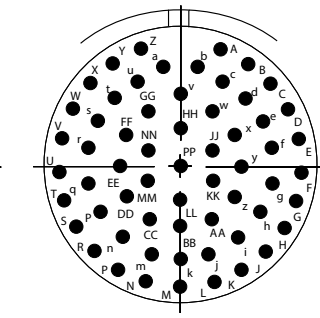

J61,  
61 # 20, I

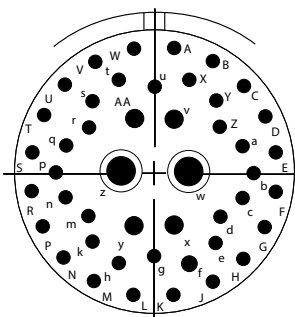

J90,  
40 # 20, 4 # 16, 2 # 8 Twinax,  
I / Twinax

38999 S III