

FEATURES

- ◆ Avalanche Rugged Technology
- ◆ Rugged Gate Oxide Technology
- ◆ Lower Input Capacitance
- ◆ Improved Gate Charge
- ◆ Extended Safe Operating Area
- ◆ Lower Leakage Current: 10µA (Max.) @ $V_{DS} = 500V$
- ◆ Lower $R_{DS(ON)}$: 0.638Ω (Typ.)

$$BV_{DSS} = 500 V$$

$$R_{DS(on)} = 0.85\Omega$$

$$I_D = 8 A$$

TO-220

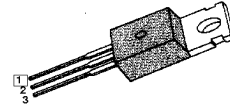

1.Gate 2. Drain 3. Source

Absolute Maximum Ratings

Symbol	Characteristic	Value	Units
V_{DSS}	Drain-to-Source Voltage	500	V
I_D	Continuous Drain Current ($T_C=25^\circ C$)	8	A
	Continuous Drain Current ($T_C=100^\circ C$)	5.1	
I_{DM}	Drain Current-Pulsed (1)	32	A
V_{GS}	Gate-to-Source Voltage	± 30	V
E_{AS}	Single Pulsed Avalanche Energy (2)	640	mJ
I_{AR}	Avalanche Current (1)	8	A
E_{AR}	Repetitive Avalanche Energy (1)	13.4	mJ
dv/dt	Peak Diode Recovery dv/dt (3)	3.5	V/ns
P_D	Total Power Dissipation ($T_C=25^\circ C$)	134	W
	Linear Derating Factor	1.08	
T_J, T_{STG}	Operating Junction and Storage Temperature Range	- 55 to +150	$^\circ C$
T_L	Maximum Lead Temp. for Soldering Purposes, 1/8. from case for 5-seconds	300	

Thermal Resistance

Symbol	Characteristic	Typ.	Max.	Units
$R_{\theta JC}$	Junction-to-Case	--	0.93	$^\circ C/W$
$R_{\theta CS}$	Case-to-Sink	0.5	--	
$R_{\theta JA}$	Junction-to-Ambient	--	62.5	



Rev. B

©1999 Fairchild Semiconductor Corporation

Electrical Characteristics ($T_C=25^\circ\text{C}$ unless otherwise specified)

Symbol	Characteristic	Min.	Typ.	Max.	Units	Test Condition
BV_{DSS}	Drain-Source Breakdown Voltage	500	--	--	V	$V_{GS}=0V, I_D=250\mu A$
$\Delta BV/\Delta T_J$	Breakdown Voltage Temp. Coeff.	--	0.66	--	V/ $^\circ\text{C}$	$I_D=250\mu A$ <i>See Fig 7</i>
$V_{GS(th)}$	Gate Threshold Voltage	2.0	--	4.0	V	$V_{DS}=5V, I_D=250\mu A$
I_{GSS}	Gate-Source Leakage, Forward	--	--	100	nA	$V_{GS}=30V$
	Gate-Source Leakage, Reverse	--	--	-100		$V_{GS}=-30V$
I_{DSS}	Drain-to-Source Leakage Current	--	--	10	μA	$V_{DS}=500V$
		--	--	100		$V_{DS}=400V, T_C=125^\circ\text{C}$
$R_{DS(on)}$	Static Drain-Source On-State Resistance	--	--	0.85	Ω	$V_{GS}=10V, I_D=4A$ (4)
g_{fs}	Forward Transconductance	--	6.8	--	\bar{O}	$V_{DS}=50V, I_D=4A$ (4)
C_{iss}	Input Capacitance	--	1190	1550	pF	$V_{GS}=0V, V_{DS}=25V, f=1\text{MHz}$ <i>See Fig 5</i>
C_{oss}	Output Capacitance	--	150	175		
C_{rss}	Reverse Transfer Capacitance	--	66	75		
$t_{d(on)}$	Turn-On Delay Time	--	18	45	ns	$V_{DD}=250V, I_D=8A,$ $R_G=9.1\Omega$ <i>See Fig 13</i> (4) (5)
t_r	Rise Time	--	22	55		
$t_{d(off)}$	Turn-Off Delay Time	--	83	175		
t_f	Fall Time	--	30	70		
Q_g	Total Gate Charge	--	57	74	nC	$V_{DS}=400V, V_{GS}=10V,$ $I_D=8A$ <i>See Fig 6 & Fig 12</i> (4) (5)
Q_{gs}	Gate-Source Charge	--	7.5	--		
Q_{gd}	Gate-Drain (. Miller.) Charge	--	28.4	--		

Source-Drain Diode Ratings and Characteristics

Symbol	Characteristic	Min.	Typ.	Max.	Units	Test Condition
I_S	Continuous Source Current	--	--	8	A	Integral reverse pn-diode in the MOSFET
I_{SM}	Pulsed-Source Current (1)	--	--	32		
V_{SD}	Diode Forward Voltage (4)	--	--	1.4	V	$T_J=25^\circ\text{C}, I_S=8A, V_{GS}=0V$
t_{rr}	Reverse Recovery Time	--	370	--	ns	$T_J=25^\circ\text{C}, I_F=8A$
Q_{rr}	Reverse Recovery Charge	--	3.9	--	μC	$di_F/dt=100A/\mu\text{s}$ (4)

Notes;

- (1) Repetitive Rating: Pulse Width Limited by Maximum Junction Temperature
- (2) $L=18\text{mH}, I_{AS}=8A, V_{DD}=50V, R_G=27\Omega,$ Starting $T_J=25^\circ\text{C}$
- (3) $I_{SD} \leq 8A, di/dt \leq 160A/\mu\text{s}, V_{DD} \leq BV_{DSS},$ Starting $T_J=25^\circ\text{C}$
- (4) Pulse Test: Pulse Width = 250 μs , Duty Cycle $\leq 2\%$
- (5) Essentially Independent of Operating Temperature

Fig 1. Output Characteristics

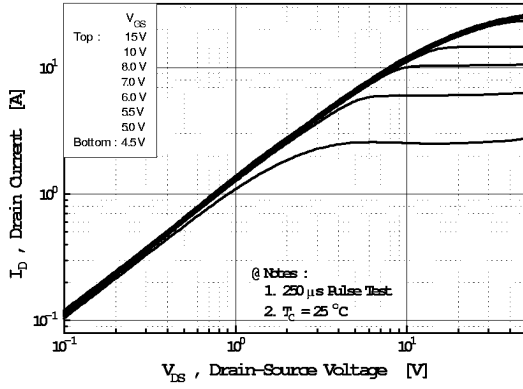

Fig 2. Transfer Characteristics

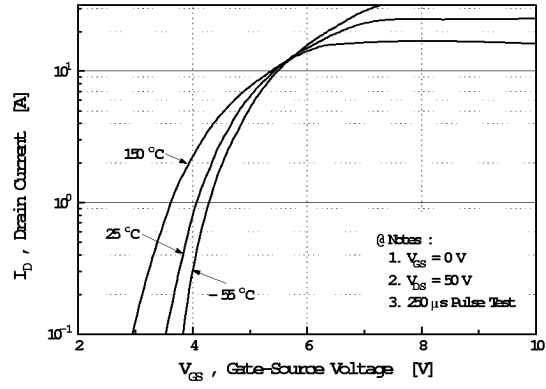

Fig 3. On-Resistance vs. Drain Current

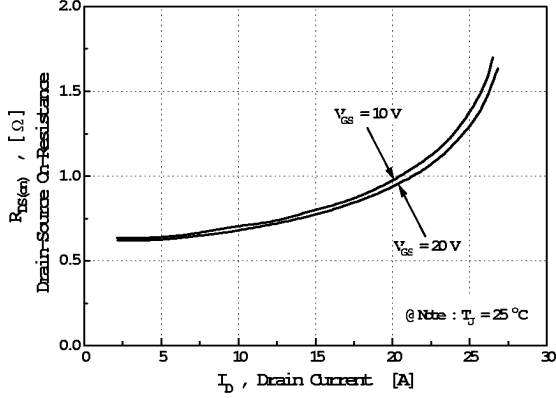

Fig 4. Source-Drain Diode Forward Voltage

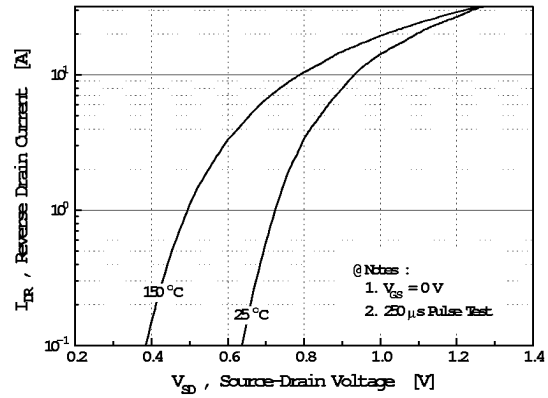

Fig 5. Capacitance vs. Drain-Source Voltage

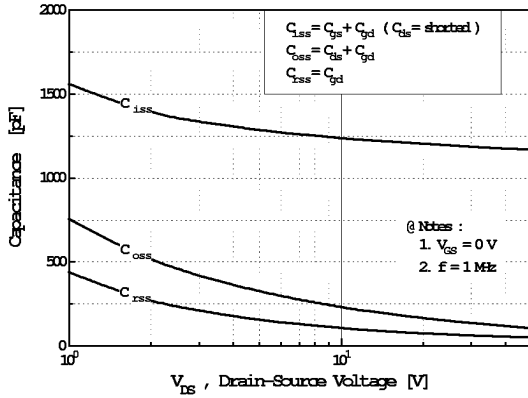

Fig 6. Gate Charge vs. Gate-Source Voltage

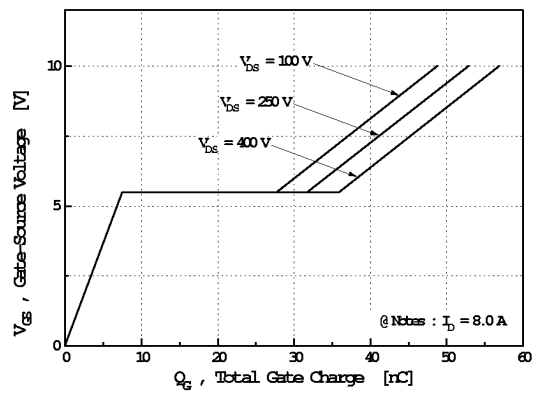

Fig 7. Breakdown Voltage vs. Temperature

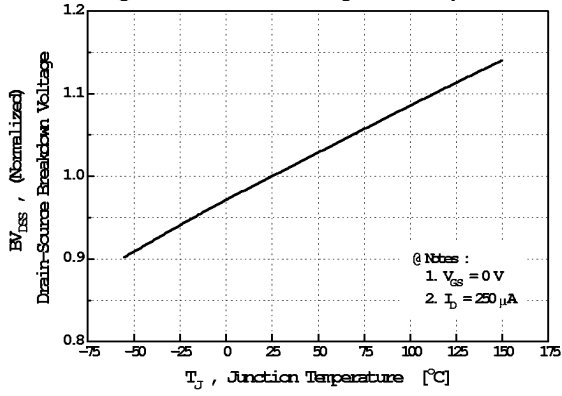

Fig 8. On-Resistance vs. Temperature

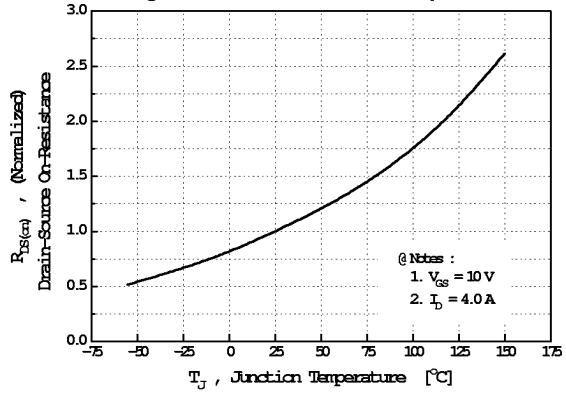

Fig 9. Max. Safe Operating Area

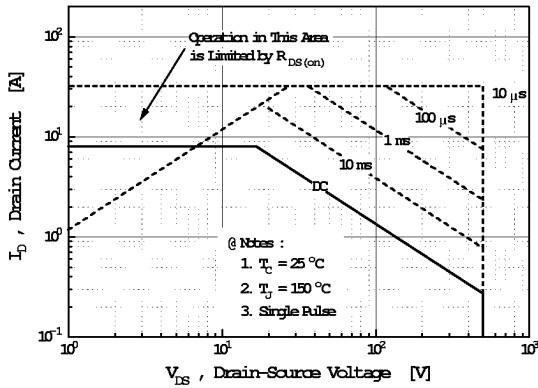

Fig 10. Max. Drain Current vs. Case Temperature

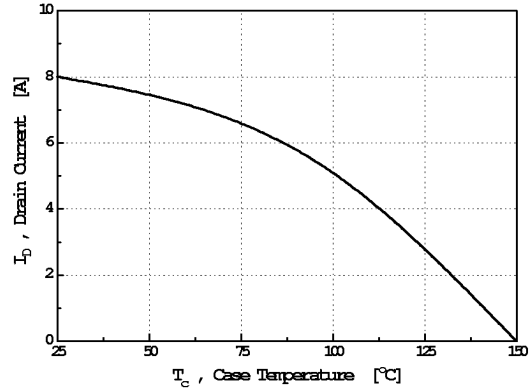

Fig 11. Thermal Response

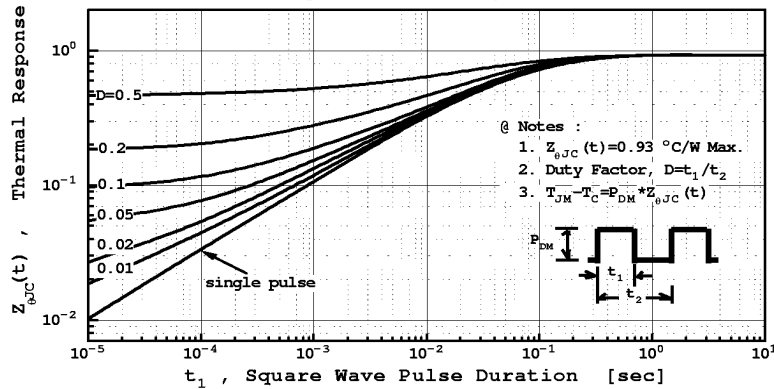

Fig 12. Gate Charge Test Circuit & Waveform

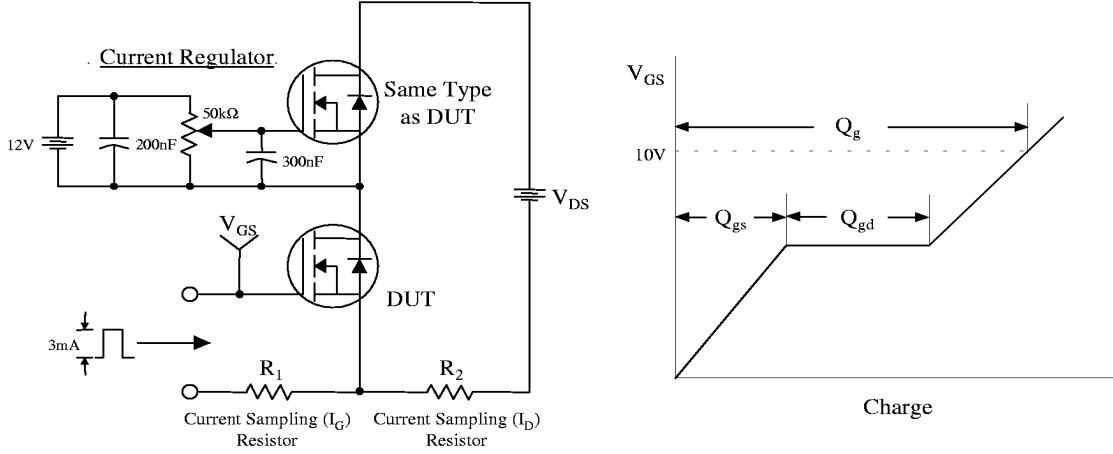

Fig 13. Resistive Switching Test Circuit & Waveforms

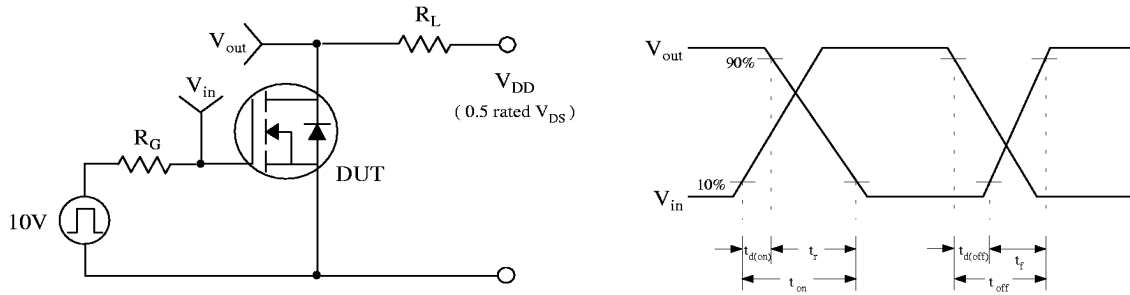

Fig 14. Unclamped Inductive Switching Test Circuit & Waveforms

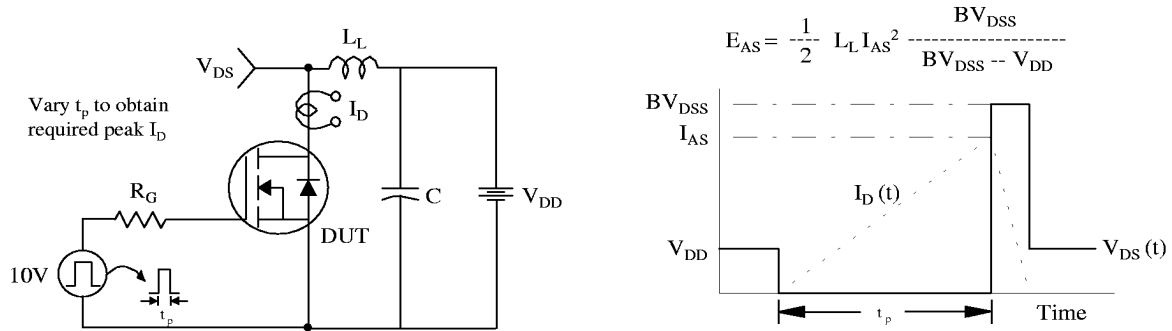

Fig 15. Peak Diode Recovery dv/dt Test Circuit & Waveforms

