

REVISION RECORD			
LTR	ECO NO:	APPROVED:	DATE:

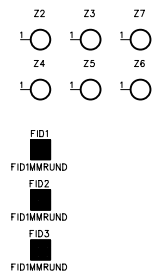
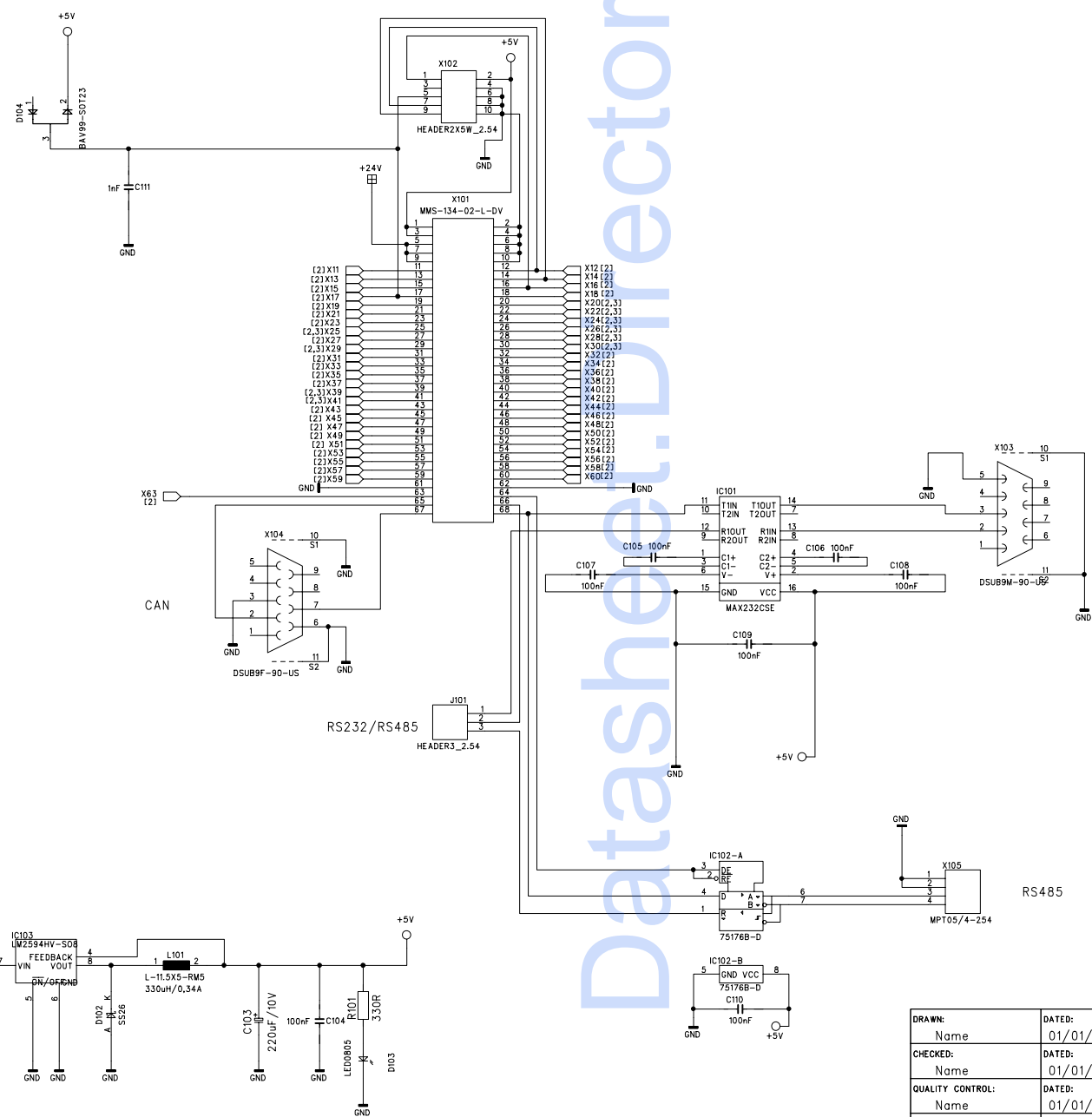

A

A

COMPANY: Trinamic Microchips GmbH				
TITLE: Title				
DRAWN: Name	DATED: 01/01/2001	CODE:	SIZE: A3	DRAWING NO:
CHECKED: Name	DATED: 01/01/2001	SCALE:	SHEET: OF	REV: 1.0
QUALITY CONTROL: Name	DATED: 01/01/2001			
RELEASED: Name	DATED: 01/01/2001			

DRAWN: Name	DATED: 01/01/2001
CHECKED: Name	DATED: 01/01/2001
QUALITY CONTROL: Name	DATED: 01/01/2001
RELEASED: Name	DATED: 01/01/2001

Datasheet Directory
 www.datasheetdirectory.com

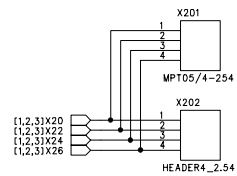

Motor 1 (TMCM-303)

Klemmen und Header hintereinander platzieren

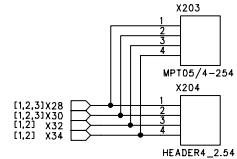

Motor 2 (TMCM-303)

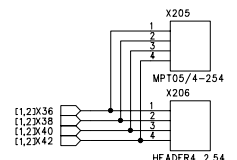

Motor 3 (TMCM-303)

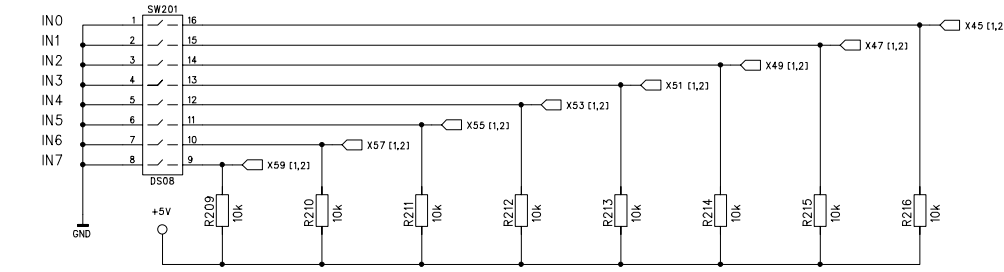
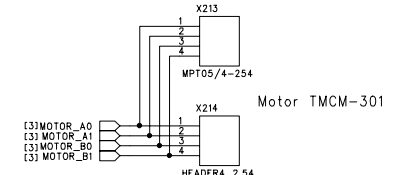
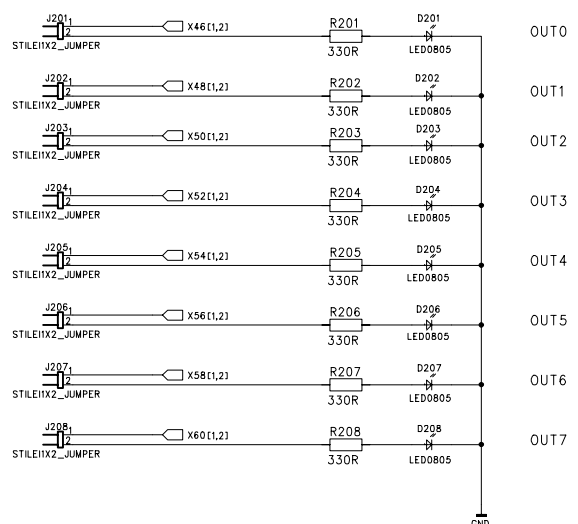
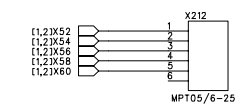
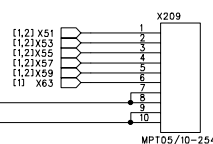
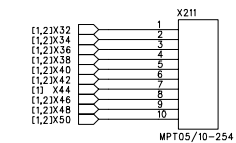
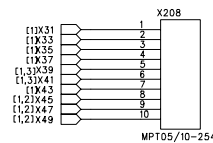
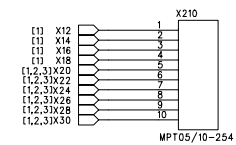
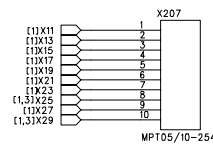

Für diese Zeichnung behalten wir uns alle Rechte vor.				Name		Masstab	
Bearb.				Datum		Name	
Gepr.							
Norm							
Ausg.				Änderung		Datum	
				Name			
PROJEKTNAME						Schaltungsname	
						Prototyp V1.0	
Blatt						Blatt	
Konstruktionsänderungen vorbehalten							



DIGITAL (TMC-301)

SCK (1,2)X30
SDI (1,2)X26
SD0 (1,2)X28
CS1 (1,2)X20
CS2 (1,2)X22
CS3 (1,2)X24

ENABLE

ANALOG (TMC-100)

DAC0 (1,2)X39
DAC1 (1,2)X41
PHA (1,2)X25
PHB (1,2)X29
ENABLE
SPE

DIP-Schalter nebeneinander platzieren

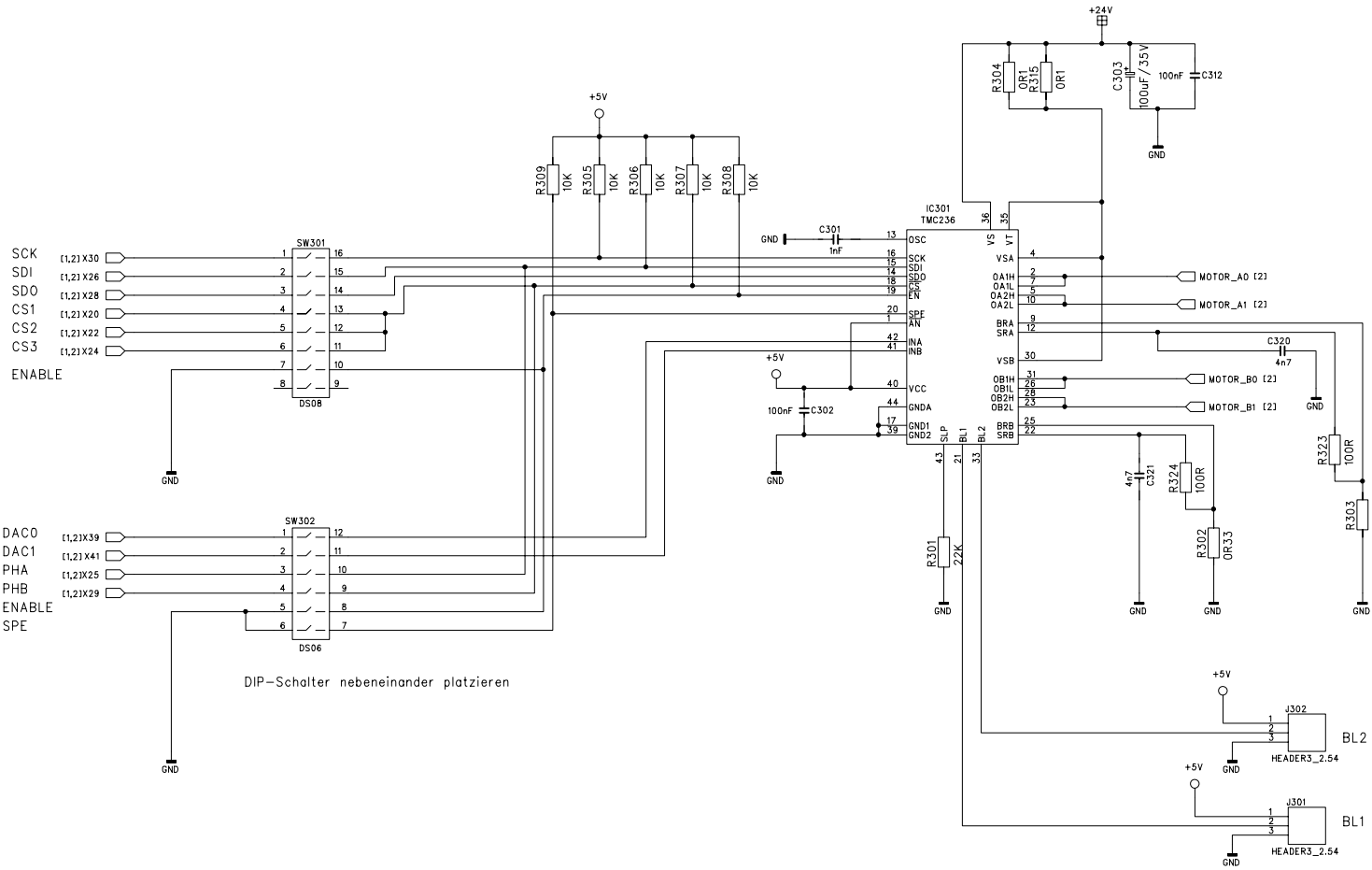

Für diese Zeichnung behalten wir uns alle Rechte vor.				Name		Masstab	
Bearb.				Datum		Name	
Gepr.				Norm		Blatt	
Ausg.				Änderung		Datum	
Name				PROJEKTNAME		Schaltungsname Prototyp V1.0	
						Konstruktionsänderungen vorbehalten	

