



±15kV ESD-Protected, 1µA, 3.0V to 5.5V, 250kbps, RS-232 Transceivers with AutoShutdown

General Description

The MAX3221E/MAX3223E/MAX3243E are 3V-powered EIA/TIA-232 and V.28/V.24 communications interfaces with automatic shutdown/wakeup features, high data-rate capabilities, and enhanced electrostatic discharge (ESD) protection. All transmitter outputs and receiver inputs are protected to ±15kV using IEC 1000-4-2 Air-Gap Discharge, to ±8kV using IEC 1000-4-2 Contact Discharge, and to ±15kV using the Human Body Model.

The MAX3221E/MAX3223E/MAX3243E achieve a 1µA supply current with Maxim's revolutionary AutoShutdown™ feature. They save power without changes to the existing BIOS or operating system by entering low-power shutdown mode when the RS-232 cable is disconnected, or when the transmitters of the connected peripherals are off.

The transceivers have a proprietary low-dropout transmitter output stage, delivering true RS-232 performance from a +3.0V to +5.5V supply with a dual charge pump. The charge pump requires only four small 0.1µF capacitors for operation from a +3.3V supply. Each device is guaranteed to run at data rates of 250kbps while maintaining RS-232 output levels.

The MAX3221E contains just one driver and one receiver, making it the smallest single-supply RS-232 transceiver. The MAX3223E has two drivers and two receivers. The MAX3243E is a complete 3-driver/5-receiver serial port ideal for notebook or subnotebook computers. It also includes two noninverting receiver outputs that are always active, allowing external devices to be monitored without forward biasing the protection diodes in circuitry that may be powered down.

The MAX3221E, MAX3223E, and MAX3243E are available in space-saving TQFN, SSOP, and TSSOP packages.

Applications

Notebook, Subnotebook, and Palmtop Computers
Cellular Phones
Battery-Powered Equipment
Handheld Equipment
Peripherals
Printers

Pin Configurations appear at end of data sheet.

Typical Operating Circuits appear at end of data sheet.

AutoShutdown and UCSP are trademarks of Maxim Integrated Products, Inc.

Next Generation Device Features

- ◆ **For Space-Constrained Applications:**
MAX3228E/MAX3229E: ±15kV ESD-Protected, +2.5V to +5.5V RS-232 Transceivers in UCSP™
MAX3222E/MAX3232E/MAX3237E/MAX3241E/
MAX3246E: ±15kV ESD-Protected Down to 10nA, +3.0V to +5.5V, Up to 1Mbps, True RS-232 Transceivers (MAX3246E Available in a UCSP Package)
- ◆ **For Data Cable Applications:**
MAX3380E/MAX3381E: +2.35V to +5.5V, 1µA, 2Tx/2Rx RS-232 Transceivers with ±15kV ESD-Protected I/O and Logic Pins

Ordering Information

PART	TEMP RANGE	PIN-PACKAGE	PKG CODE
MAX3221ECTE	0°C to +70°C	16 Thin QFN-EP (5mm x 5mm)	T1655-2
MAX3221ECUE	0°C to +70°C	16 TSSOP	—
MAX3221ECAE	0°C to +70°C	16 SSOP	—
MAX3221EEAE	-40°C to +85°C	16 SSOP	—
MAX3221EETE	-40°C to +85°C	16 Thin QFN-EP (5mm x 5mm)	T1655-2
MAX3221EEUE	-40°C to +85°C	16 TSSOP	—
MAX3223ECP	0°C to +70°C	20 Plastic DIP	—
MAX3223ECAP	0°C to +70°C	20 SSOP	—
MAX3223ECUP	0°C to +70°C	20 TSSOP	—
MAX3223ECTP	0°C to +70°C	20 Thin QFN-EP* (5mm x 5mm)	T2055-5
MAX3223EEPP	-40°C to +85°C	20 Plastic DIP	—
MAX3223EEAP	-40°C to +85°C	20 SSOP	—
MAX3223EEUP	-40°C to +85°C	20 TSSOP	—
MAX3223EETP	-40°C to +85°C	20 Thin QFN-EP* (5mm x 5mm)	T2055-5

* Exposed paddle.

Ordering Information continued at end of data sheet.

Selector Guide

PART	NO. OF DRIVERS/RECEIVERS	VCC RANGE (V)	AutoShutdown
MAX3221E	1/1	+3.0 to +5.5	✓
MAX3223E	2/2	+3.0 to +5.5	✓
MAX3243E	3/5	+3.0 to +5.5	✓

MAX3221E/MAX3223E/MAX3243E

±15kV ESD-Protected, 1µA, 3.0V to 5.5V, 250kbps, RS-232 Transceivers with AutoShutdown

ABSOLUTE MAXIMUM RATINGS

V _{CC} to GND	-0.3V to +6V	16-Pin TSSOP (derate 9.4mW/°C above +70°C)	754.7mW
V ₊ to GND (Note 1)	-0.3V to +7V	16-Pin TQFN (derate 20.8mW/°C above +70°C)	1666.7mW
V ₋ to GND (Note 1)	+0.3V to -7V	20-Pin Plastic DIP (derate 11.11mW/°C above +70°C)	889mW
V ₊ + V ₋ (Note 1)	+13V	20-Pin SSOP (derate 8.00mW/°C above +70°C)	640mW
Input Voltages		20-Pin TSSOP (derate 10.9mW/°C above +70°C)	879mW
T _{IN} , $\overline{\text{EN}}$, FORCEON, $\overline{\text{FORCEOFF}}$ to GND	-0.3V to +6V	20-Pin TQFN (derate 21.3mW/°C above +70°C)	1702.1mW
R _{IN} to GND	±25V	28-Pin SSOP (derate 9.52mW/°C above +70°C)	762mW
Output Voltages		28-Pin TSSOP (derate 12.8mW/°C above +70°C)	1026mW
T _{OUT} to GND	±13.2V	Operating Temperature Ranges	
R _{OUT} , R _{2OUTB} , $\overline{\text{INVALID}}$ to GND	-0.3V to (V _{CC} + 0.3V)	MAX32_ <u> </u> _EC_ <u> </u>	0°C to +70°C
Short-Circuit Duration		MAX32_ <u> </u> _EE_ <u> </u>	-40°C to +85°C
T _{OUT} to GND	Continuous	Storage Temperature Range	-65°C to +160°C
Continuous Power Dissipation (T _A = +70°C)		Lead Temperature (soldering, 10s)	+300°C
16-Pin SSOP (derate 7.14mW/°C above +70°C)	571mW		

Note 1: V₊ and V₋ can have maximum magnitudes of 7V, but their absolute difference cannot exceed 13V.

Stresses beyond those listed under "Absolute Maximum Ratings" may cause permanent damage to the device. These are stress ratings only, and functional operation of the device at these or any other conditions beyond those indicated in the operational sections of the specifications is not implied. Exposure to absolute maximum rating conditions for extended periods may affect device reliability.

ELECTRICAL CHARACTERISTICS

(V_{CC} = +3.0V to +5.5V, C₁–C₄ = 0.1µF (Note 2), T_A = T_{MIN} to T_{MAX}, unless otherwise noted. Typical values are at T_A = +25°C.)

PARAMETER	SYMBOL	CONDITIONS	MIN	TYP	MAX	UNITS
DC CHARACTERISTICS (V _{CC} = 3.3V or 5.0V, T _A = +25°C)						
Supply Current, AutoShutdown		FORCEON = GND, $\overline{\text{FORCEOFF}}$ = V _{CC} , all R _{IN} open		1.0	10	µA
Supply Current, Shutdown		$\overline{\text{FORCEOFF}}$ = GND, all R _{IN} = GND		1.0	10	µA
Supply Current, AutoShutdown Disabled		FORCEON = $\overline{\text{FORCEOFF}}$ = V _{CC} , no load		0.3	1	mA
LOGIC INPUTS						
Input Logic Threshold Low		T _{IN} , $\overline{\text{EN}}$, FORCEON, $\overline{\text{FORCEOFF}}$			0.8	V
Input Logic Threshold High		T _{IN} , $\overline{\text{EN}}$, FORCEON, $\overline{\text{FORCEOFF}}$	V _{CC} = 3.3V	2.0		V
			V _{CC} = 5.0V	2.4		
Transmitter Input Hysteresis				0.5		V
Input Leakage Current		T _{IN} , $\overline{\text{EN}}$, FORCEON, $\overline{\text{FORCEOFF}}$		±0.01	±1	µA
RECEIVER OUTPUTS						
Output Leakage Current		R _{OUT} receivers disabled		±0.05	±10	µA
Output Voltage Low		I _{OUT} = 1.6mA			0.4	V
Output Voltage High		I _{OUT} = -1.0mA	V _{CC} - 0.6	V _{CC} - 0.1		V
AutoShutdown (FORCEON = GND, $\overline{\text{FORCEOFF}}$ = V _{CC})						
Receiver Input Threshold to $\overline{\text{INVALID}}$ Output High		Figure 5a	Positive threshold		2.7	V
			Negative threshold	-2.7		
Receiver Input Threshold to $\overline{\text{INVALID}}$ Output Low		Figure 5a	-0.3		0.3	V
$\overline{\text{INVALID}}$ Output Voltage Low		I _{OUT} = 1.6mA			0.4	V
$\overline{\text{INVALID}}$ Output Voltage High		I _{OUT} = -1.0mA	V _{CC} - 0.6			V

±15kV ESD-Protected, 1µA, 3.0V to 5.5V, 250kbps, RS-232 Transceivers with AutoShutdown

ELECTRICAL CHARACTERISTICS (continued)

(V_{CC} = +3.0V to +5.5V, C1–C4 = 0.1µF (Note 2), T_A = T_{MIN} to T_{MAX}, unless otherwise noted. Typical values are at T_A = +25°C.)

PARAMETER	SYMBOL	CONDITIONS	MIN	TYP	MAX	UNITS	
Receiver Positive or Negative Threshold to $\overline{\text{INVALID}}$ High	t _{INVH}	V _{CC} = 5V, Figure 5b		1		µs	
Receiver Positive or Negative Threshold to $\overline{\text{INVALID}}$ Low	t _{INVL}	V _{CC} = 5V, Figure 5b		30		µs	
Receiver or Transmitter Edge to Transmitters Enabled	t _{WU}	V _{CC} = 5V, Figure 5b		100		µs	
RECEIVER INPUTS							
Input Voltage Range			-25		25	V	
Input Threshold Low		T _A = +25°C	V _{CC} = 3.3V	0.6	1.2	V	
			V _{CC} = 5.0V	0.8	1.5		
Input Threshold High		T _A = +25°C	V _{CC} = 3.3V		1.5	2.4	V
			V _{CC} = 5.0V		1.8	2.4	
Input Hysteresis				0.5		V	
Input Resistance			3	5	7	kΩ	
TRANSMITTER OUTPUTS							
Output Voltage Swing		All transmitter outputs loaded with 3kΩ to ground	±5	±5.4		V	
Output Resistance		V _{CC} = V ₊ = V ₋ = 0, T _{OUT} = ±2V	300	10M		Ω	
Output Short-Circuit Current					±60	mA	
Output Leakage Current		V _{OUT} = ±12V, V _{CC} = 0 or 3V to 5.5V, transmitters disabled			±25	µA	
MOUSE DRIVEABILITY (MAX3243E)							
Transmitter Output Voltage		T1IN = T2IN = GND, T3IN = V _{CC} , T3OUT loaded with 3kΩ to GND, T1OUT and T2OUT loaded with 2.5mA each	±5.0			V	
ESD PROTECTION							
R_IN, T_OUT		IEC 1000-4-2 Air-Gap Discharge		±15		kV	
		IEC 1000-4-2 Contact Discharge		±8			
		Human Body Model		±15			

±15kV ESD-Protected, 1µA, 3.0V to 5.5V, 250kbps, RS-232 Transceivers with AutoShutdown

TIMING CHARACTERISTICS—MAX3221E/MAX3223E/MAX3243E

(V_{CC} = +3.0V to +5.5V, C₁–C₄ = 0.1µF (Note 2), T_A = T_{MIN} to T_{MAX}, unless otherwise noted. Typical values are at T_A = +25°C.)

PARAMETER	SYMBOL	CONDITIONS		MIN	TYP	MAX	UNITS
Maximum Data Rate		R _L = 3kΩ, C _L = 1000pF, one transmitter switching		250			kbps
Receiver Propagation Delay	t _{PHL}	C _L = 150pF			0.15		µs
	t _{PLH}				0.15		
Receiver Output Enable Time		Normal operation			200		ns
Receiver Output Disable Time		Normal operation			200		ns
Transmitter Skew	t _{PHL} - t _{PLH}	(Note 3)			100		ns
Receiver Skew	t _{PHL} - t _{PLH}				50		ns
Transition-Region Slew Rate		V _{CC} = 3.3V, R _L = 3kΩ to 7kΩ, T _A = +25°C, measured from +3V to -3V or -3V to +3V, one transmitter switching	C _L = 150pF to 1000pF	6		30	V/µs

Note 2: C₁–C₄ = 0.1µF, tested at 3.3V ±10%. C₁ = 0.047µF, C₂–C₄ = 0.33µF, tested at 5.0V ±10%.

Note 3: Transmitter skew is measured at the transmitter zero cross points.

Typical Operating Characteristics

(V_{CC} = +3.3V, 250kbps data rate, 0.1µF capacitors, all transmitters loaded with 3kΩ and C_L, T_A = +25°C, unless otherwise noted.)

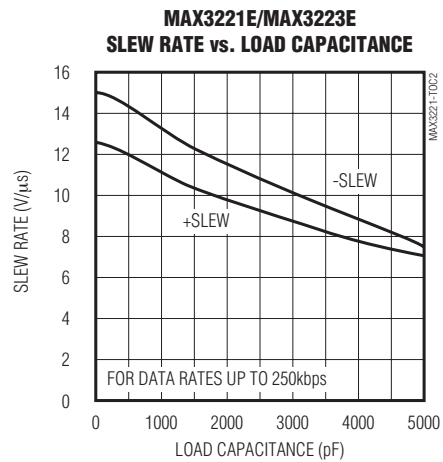
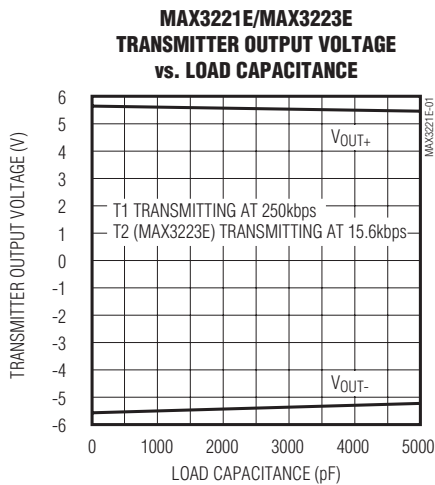

±15kV ESD-Protected, 1μA, 3.0V to 5.5V, 250kbps, RS-232 Transceivers with AutoShutdown

MAX3221E/MAX3223E/MAX3243E

Typical Operating Characteristics (continued)

(V_{CC} = +3.3V, 250kbps data rate, 0.1μF capacitors, all transmitters loaded with 3kΩ and C_L, T_A = +25°C, unless otherwise noted.)

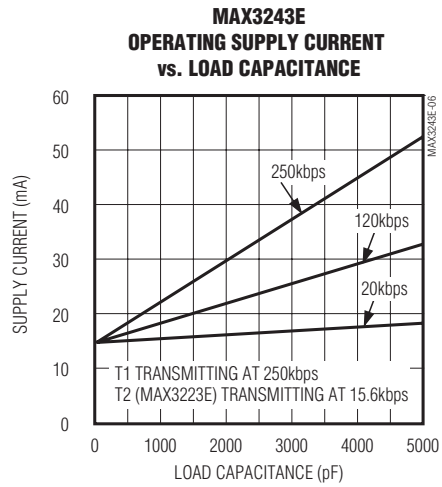
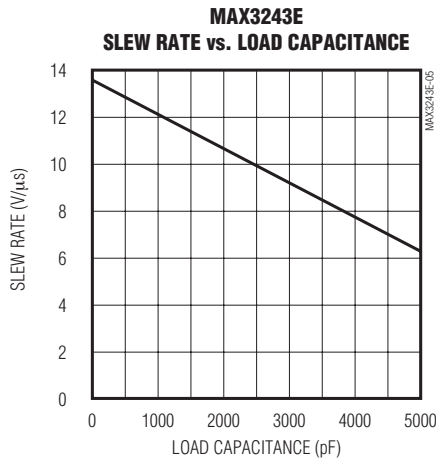
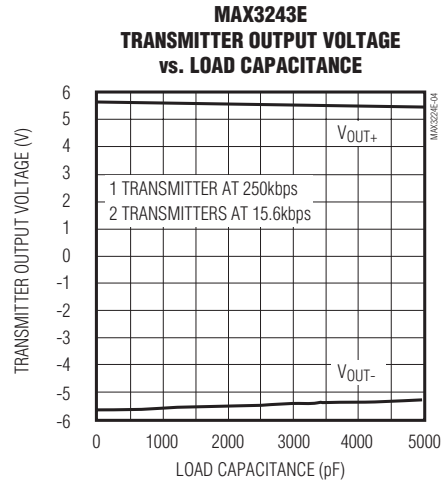
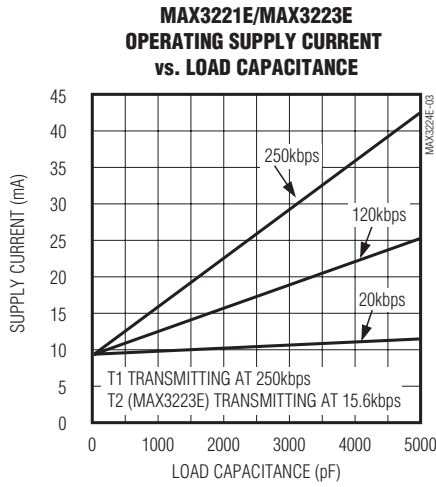

±15kV ESD-Protected, 1µA, 3.0V to 5.5V, 250kbps, RS-232 Transceivers with AutoShutdown

Pin Description

PIN						NAME	FUNCTION
MAX3221E		MAX3223E		MAX3243E			
TQFN	SSOP/ TSSOP	TQFN	DIP/ SSOP/ TSSOP	SO/ SSOP/ TSSOP	THIN QFN		
14	1	19	1	—	22	$\overline{\text{EN}}$	Receiver Enable Control. Drive low for normal operation. Drive high to force the receiver outputs (R_OUT) into a high-impedance state.
16	2	1	2	28	28	C1+	Positive terminal of the voltage doubler Charge-Pump Capacitor
15	3	20	3	27	27	V+	+5.5V generated by the charge pump
1	4	2	4	24	23	C1-	Negative terminal of the voltage doubler Charge-Pump Capacitor
2	5	3	5	1	29	C2+	Positive terminal of inverting Charge-Pump Capacitor
3	6	4	6	2	30	C2-	Negative terminal of inverting Charge-Pump Capacitor
4	7	5	7	3	31	V-	-5.5V generated by the charge pump
5	8	7, 14	9, 16	4-8	1-5	R_IN	RS-232 Receiver Inputs
6	9	8, 13	10, 15	15-19	13, 14, 15, 17, 18	R_OUT	TTL/CMOS Receiver Outputs
7	10	9	11	21	—	$\overline{\text{INVALID}}$	Output of the Valid Signal Detector. $\overline{\text{INVALID}}$ is enabled high if a valid RS-232 level is present on any receiver input.
8	11	10, 11	12, 13	12, 13, 14	10, 11, 12	T_IN	TTL/CMOS Transmitter Inputs
9	12	12	14	23	—	FORCEON	Drive high to override automatic circuitry keeping transmitters and charge pump on ($\overline{\text{FORCEOFF}}$ must be high) (Table 1).
10	13	6, 15	8, 17	9, 10, 11	6, 7, 8	T_OUT	RS-232 Transmitter Outputs
—	—	—	—	20	19	R2OUTB	TTL/CMOS Noninverting Complementary Receiver Output. Always active.
11	14	16	18	25	24	GND	Ground
12	15	17	19	26	26	V _{CC}	+3.0V to +5.5V Supply Voltage
13	16	18	20	22	—	$\overline{\text{FORCEOFF}}$	Force-Off Input, active low. Drive low to shut down transmitters, receivers (MAX3243E, except R2OUTB), and on-board charge pump. This overrides all automatic circuitry and FORCEON (Table 1).
—	—	—	—	—	21	$\overline{\text{SHDN}}$	Shutdown Control, Active Low

±15kV ESD-Protected, 1µA, 3.0V to 5.5V, 250kbps, RS-232 Transceivers with AutoShutdown

MAX3221E/MAX3223E/MAX3243E

Pin Description (continued)

PIN						NAME	FUNCTION
MAX3221E		MAX3223E		MAX3243E			
TQFN	SSOP/ TSSOP	TQFN	DIP/ SSOP/ TSSOP	SO/ SSOP/ TSSOP	THIN QFN		
—	—	—	—	—	19, 20	R_OUTB	Noninverting Complementary Receiver Outputs. Always active.
—	—	—	—	—	9, 16, 25, 32	N.C.	No Connection. Not internally connected.
EP	—	EP	—	—	EP	GND	Exposed Paddle. Solder the exposed paddle to the ground plane or leave unconnected.

Detailed Description

Dual Charge-Pump Voltage Converter

The MAX3221E/MAX3223E/MAX3243E's internal power supply consists of a regulated dual charge pump that provides output voltages of +5.5V (doubling charge pump) and -5.5V (inverting charge pump), over the +3.0V to +5.5V V_{CC} range. The charge pumps operate in discontinuous mode: if the output voltages are less than 5.5V, the charge pumps are enabled; if the output voltages exceed 5.5V, the charge pumps are disabled. Each charge pump requires a flying capacitor (C1, C2) and a reservoir capacitor (C3, C4) to generate the V₊ and V₋ supplies.

RS-232 Transmitters

The transmitters are inverting level translators that convert CMOS-logic levels to 5.0V EIA/TIA-232 levels. They guarantee a 250kbps data rate with worst-case loads of 3kΩ in parallel with 1000pF, providing compatibility with PC-to-PC communication software such as LapLink™. Transmitters can be paralleled to drive multiple receivers. The MAX3243E has been specifically designed to drive serial mice. Figure 1 shows a complete system connection. When FORCEOFF is driven to ground, or the AutoShutdown circuitry senses invalid voltage levels on all receiver inputs, the transmitters are disabled and the outputs are forced into a high-impedance state. When powered off or shut down, the output can be driven up to ±12V. The transmitter inputs do not have pull-up resistors.

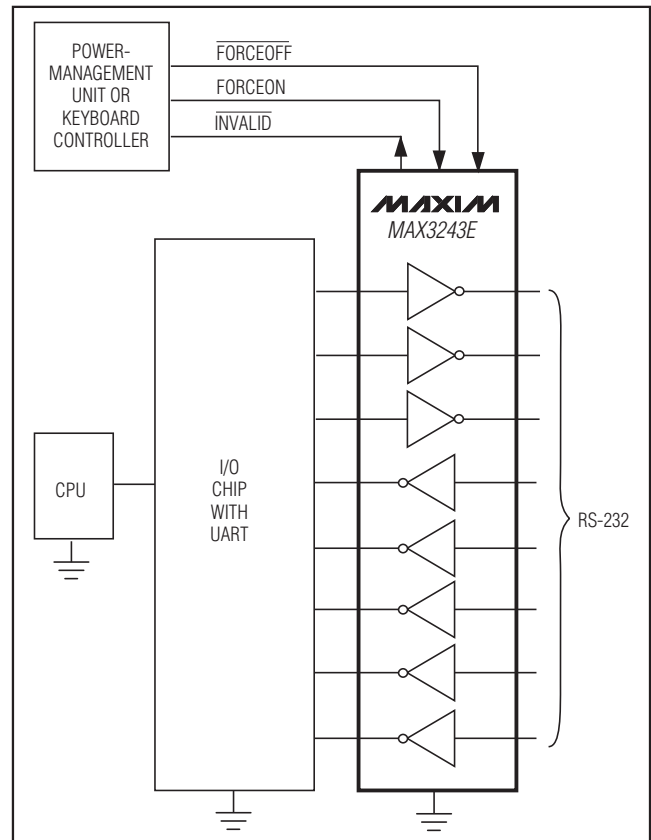

Figure 1. Interface Under Control of PMU

LapLink is a trademark of Traveling Software.

±15kV ESD-Protected, 1µA, 3.0V to 5.5V, 250kbps, RS-232 Transceivers with AutoShutdown

RS-232 Receivers

The MAX3221E/MAX3223E/MAX3243E's receivers convert RS-232 signals to CMOS-logic output levels. All receivers have inverting three-state outputs and can be active or inactive. In shutdown ($\overline{\text{FORCEOFF}} = \text{low}$) or in AutoShutdown, the MAX3221E/MAX3223E's receivers are active (Table 1). Drive $\overline{\text{EN}}$ high to place the receiver(s) in a high-impedance state. The MAX3243E's receivers are high-impedance when the part is in shutdown ($\overline{\text{FORCEOFF}} = \text{low}$).

The MAX3243E features an extra, always-active complementary output (R2OUTB). R2OUTB monitors receiver activity while the other receivers are high-impedance. This allows Ring Indicator to be monitored without forward biasing other devices connected to the receiver outputs. This is ideal for systems where V_{CC} drops to 0 in shutdown to accommodate peripherals such as UARTs (Figure 2).

The MAX3221E/MAX3223E/MAX3243E feature an $\overline{\text{INVALID}}$ output that is enabled low when no valid RS-232 signal levels have been detected on all receiver inputs. $\overline{\text{INVALID}}$ is functional in any mode (Figures 3 and 5).

AutoShutdown

The MAX3221E/MAX3223E/MAX3243E achieve a 1µA supply current with Maxim's new AutoShutdown feature, which operates when $\overline{\text{FORCEON}}$ is low and $\overline{\text{FORCEOFF}}$ is high. When these devices sense no valid signal levels on all receiver inputs for 30µs, the on-board charge pump and drivers are shut off, reducing supply current to 1µA. This occurs if the RS-232 cable is disconnected or the connected peripheral transmitters are turned off. The device turns on again when a valid level is applied to any RS-232 receiver input. As a result, the system saves power without changes to the existing BIOS or operating system.

Table 2 and Figure 3c summarize the MAX3221E/MAX3223E/MAX3243E operating modes. $\overline{\text{FORCEON}}$ and $\overline{\text{FORCEOFF}}$ override AutoShutdown. When neither control is asserted, the IC selects between these states automatically, based on receiver input levels. Figures 3a, 3b, and 5a depict valid and invalid RS-232 receiver levels. Figure 5 shows the input levels and timing diagram for AutoShutdown operation.

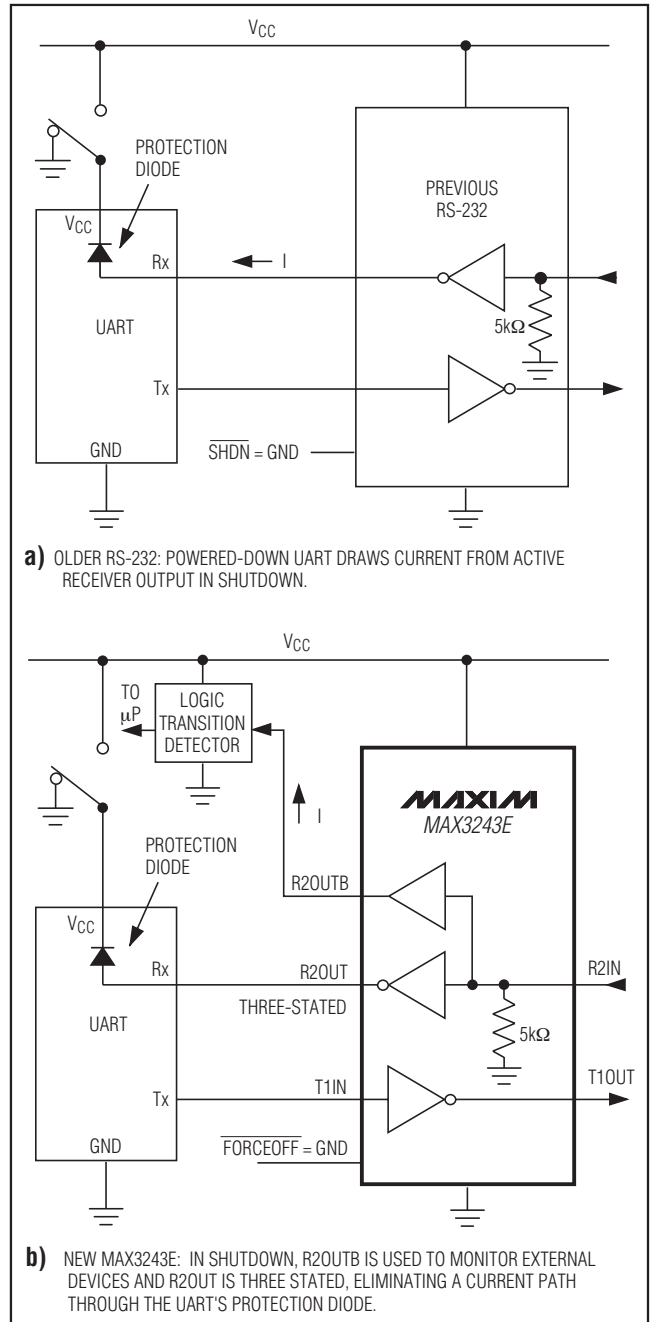

Figure 2. The MAX3243E detects RS-232 activity when the UART and interface are shut down.

±15kV ESD-Protected, 1µA, 3.0V to 5.5V, 250kbps, RS-232 Transceivers with AutoShutdown

MAX3221E/MAX3223E/MAX3243E

Table 1. Output Control Truth Table

OPERATION STATUS	FORCEON	FORCEOFF	EN (MAX3221E/MAX3223E)	VALID RECEIVER LEVEL	T_OUT	R_OUT (MAX3221E/MAX3223E)	R_OUT (MAX3243E)	R2OUTB (MAX3243E)
Shutdown (Forced Off)	X	0	0	X	High-Z	Active	High-Z	Active
	X	0	1	X	High-Z	High-Z	High-Z	Active
Normal Operation (Forced On)	1	1	0	X	Active	Active	Active	Active
	1	1	1	X	Active	High-Z	Active	Active
Normal Operation (AutoShutdown)	0	1	0	Yes	Active	Active	Active	Active
	0	1	1	Yes	Active	High-Z	Active	Active
Shutdown (AutoShutdown)	0	1	0	No	High-Z	Active	Active	Active
	0	1	1	No	High-Z	High-Z	Active	Active

X = Don't Care

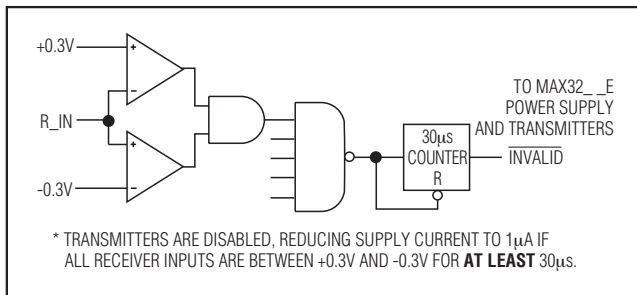

Figure 3a. MAX3221E/MAX3223E/MAX3243E Entering 1µA Supply Mode via AutoShutdown

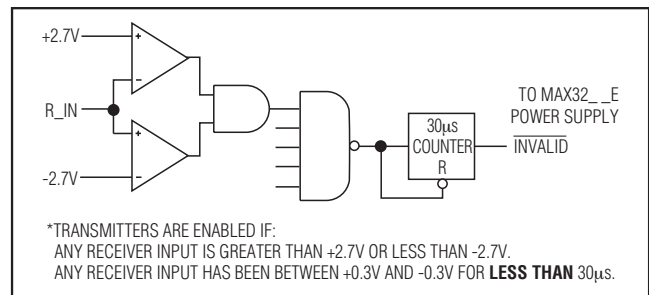

Figure 3b. MAX3221E/MAX3223E/MAX3243E with Transmitters Enabled Using AutoShutdown

A mouse or other system with AutoShutdown may need time to wake up. Figure 4 shows a circuit that forces the transmitters on for 100ms, allowing enough time for the other system to realize that the MAX3221E/MAX3223E/MAX3243E are awake. If the other system transmits valid RS-232 signals within that time, the RS-232 ports on both systems remain enabled.

When shut down, the device's charge pumps are off, V+ is pulled to VCC, V- is pulled to ground, and the transmitter outputs are high impedance. The time required to exit shutdown is typically 100µs (Figure 5b).

Software-Controlled Shutdown

If direct software control is desired, INVALID can be used to indicate DTR or Ring Indicator signal. Connect FORCEOFF and FORCEON together to disable AutoShutdown so the line acts like a SHDN input.

±15kV ESD Protection

As with all Maxim devices, ESD-protection structures are incorporated on all pins to protect against electrostatic discharges encountered during handling and assembly. The driver outputs and receiver inputs of the MAX3221E/MAX3223E/MAX3243E have extra protection against static electricity. Maxim's engineers have developed state-of-the-art structures to protect these pins against ESD of ±15kV without damage. The ESD structures withstand high ESD in all states: normal operation, shutdown, and powered down. After an ESD event, Maxim's E versions keep working without latching, whereas competing RS-232 products can latch and must be powered down to remove latching. See Table 4.

±15kV ESD-Protected, 1µA, 3.0V to 5.5V, 250kbps, RS-232 Transceivers with AutoShutdown

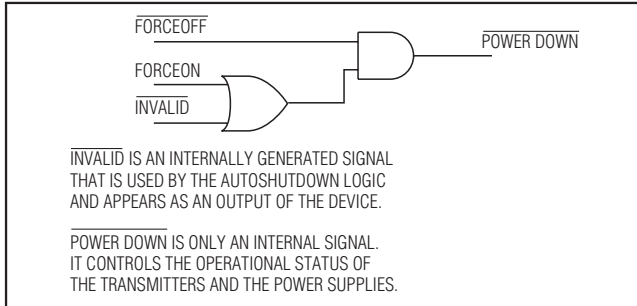

Figure 3c. MAX32_E AutoShutdown Logic

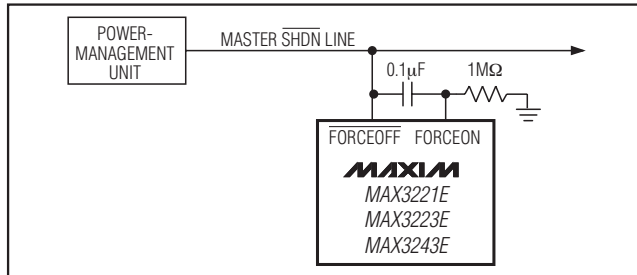

Figure 4. AutoShutdown with Initial Turn-On to Wake Up a Mouse or Another System

ESD protection can be tested in various ways; the transmitter outputs and receiver inputs of this product family are characterized for protection to the following limits:

- 1) ±15kV using the Human Body Model
- 2) ±8kV using the Contact Discharge Method specified in IEC1000-4-2
- 3) ±15kV using IEC1000-4-2's Air-Gap Method

ESD Test Conditions

ESD performance depends on a variety of conditions. Contact Maxim for a reliability report that documents test setup, test methodology, and test results.

Human Body Model

Figure 6a shows the Human Body Model, and Figure 6b shows the current waveform it generates when discharged into a low impedance. This model consists of a 100pF capacitor charged to the ESD voltage of interest, which is then discharged into the test device through a 1.5kΩ resistor.

IEC1000-4-2

The IEC1000-4-2 standard covers ESD testing and performance of finished equipment; it does not specifically refer to integrated circuits. The MAX3221E/ MAX3223E/ MAX3243E help you design equipment that meets

Table 2. INVALID Truth Table

RS-232 SIGNAL PRESENT AT ANY RECEIVER INPUT	INVALID OUTPUT
Yes	High
No	Low

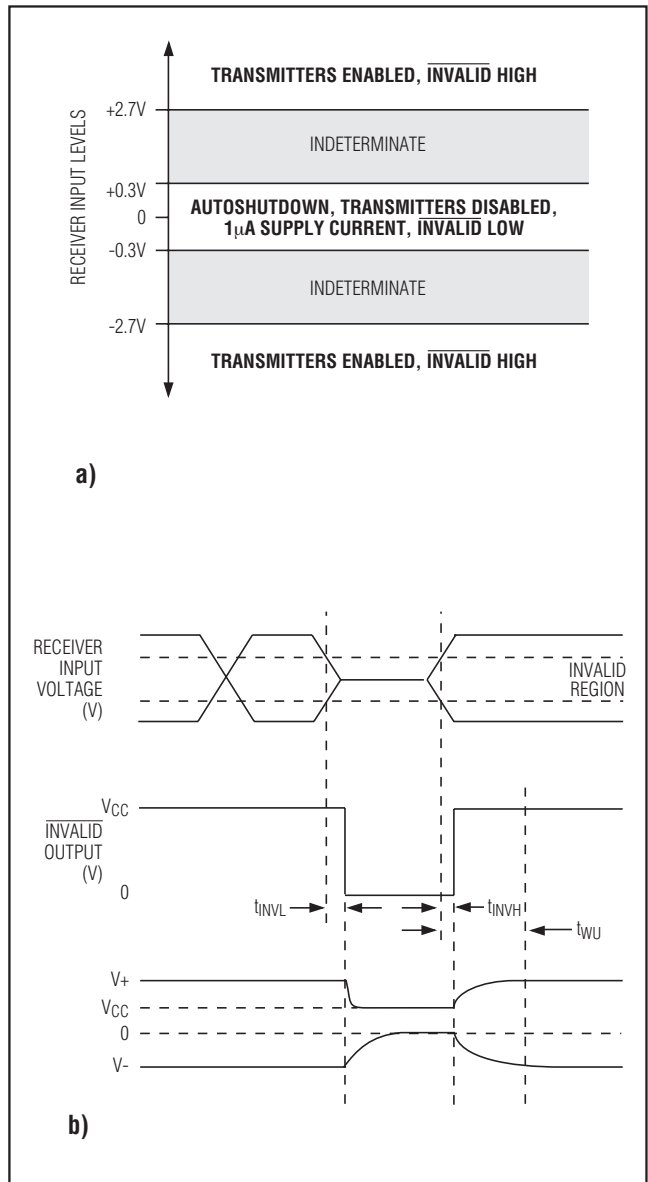

Figure 5. AutoShutdown Trip Levels

±15kV ESD-Protected, 1μA, 3.0V to 5.5V, 250kbps, RS-232 Transceivers with AutoShutdown

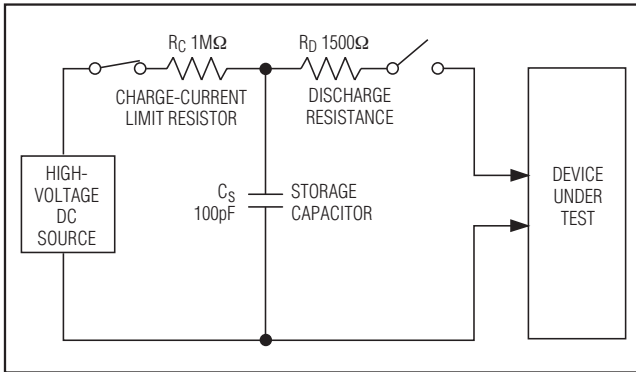

Figure 6a. Human Body ESD Test Models

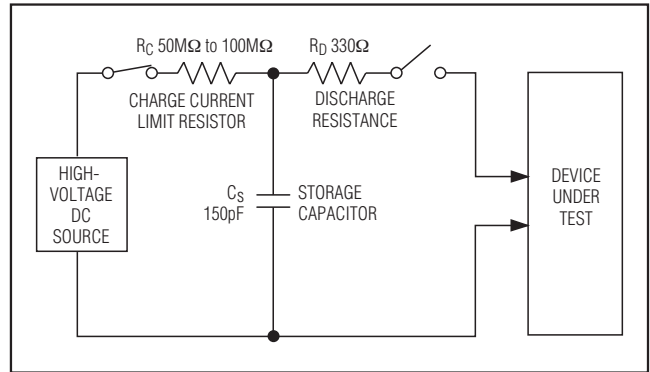

Figure 7a. IEC1000-4-2 ESD Test Model

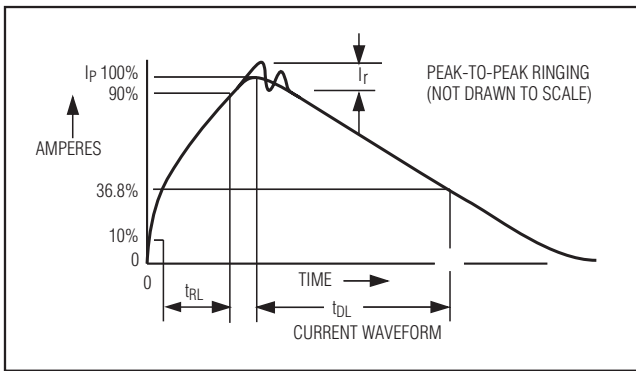

Figure 6b. Human Body Model Current Waveform

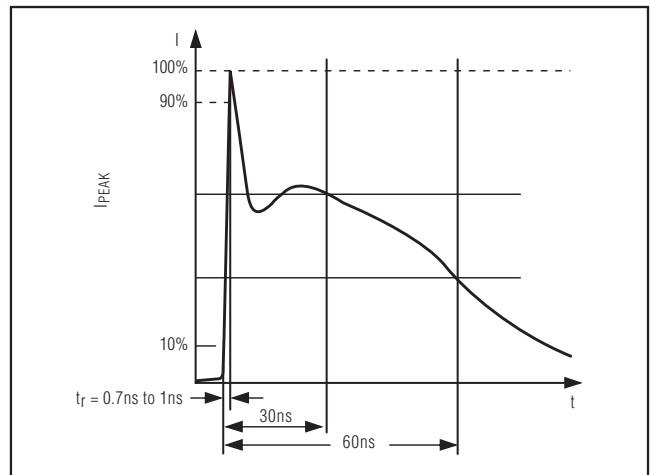

Figure 7b. IEC1000-4-2 ESD Generator Current Waveform

Level 4 (the highest level) of IEC1000-4-2, without the need for additional ESD-protection components.

The major difference between tests done using the Human Body Model and IEC1000-4-2 is higher peak current in IEC1000-4-2, because series resistance is lower in the IEC1000-4-2 model. Hence, the ESD withstand voltage measured to IEC1000-4-2 is generally lower than that measured using the Human Body Model. Figure 7a shows the IEEE1000-4-2 model and Figure 7b shows the current waveform for the ±8kV IEC1000-4-2 Level 4 ESD contact-discharge test.

The air-gap test involves approaching the device with a charged probe. The contact-discharge method connects the probe to the device before the probe is energized.

Machine Model

The Machine Model for ESD tests all pins using a 200pF storage capacitor and zero discharge resistance. Its objective is to emulate the stress caused by contact that occurs with handling and assembly during manufacturing. Of course, all pins require this protection during manufacturing, not just RS-232 inputs and outputs.

Therefore, after PC board assembly, the Machine Model is less relevant to I/O ports.

Applications Information

Capacitor Selection

The capacitor type used for C1–C4 is not critical for proper operation; either polarized or nonpolarized capacitors may be used. The charge pump requires 0.1μF capacitors for 3.3V operation. For other supply voltages, refer to Table 3 for required capacitor values. Do not use values smaller than those listed in Table 3. Increasing the capacitor values (e.g., by a factor of 2) reduces ripple on the transmitter outputs and slightly reduces power consumption. C2, C3, and C4 can be increased without changing C1's value. **However, do not increase C1 without also increasing the values of C2, C3, and C4 to maintain the proper ratios (C1 to the other capacitors).**

±15kV ESD-Protected, 1µA, 3.0V to 5.5V, 250kbps, RS-232 Transceivers with AutoShutdown

When using the minimum required capacitor values, make sure the capacitor value does not degrade excessively with temperature. If in doubt, use capacitors with a larger nominal value. The capacitor's equivalent series resistance (ESR) usually rises at low temperatures and influences the amount of ripple on V+ and V-.

Power-Supply Decoupling

In most circumstances, a 0.1µF V_{CC} bypass capacitor is adequate. In applications that are sensitive to power-supply noise, use a capacitor of the same value as the charge-pump capacitor C1. Connect bypass capacitors as close to the IC as possible.

Transmitter Outputs when Exiting Shutdown

Figure 8 shows two transmitter outputs when exiting shut down mode. As they become active, the two transmitter outputs are shown going to opposite RS-232 levels (one transmitter output is high, the other is low). Each transmitter is loaded with 3kΩ in parallel with 1000pF. The transmitter outputs display no ringing or undesirable transients as they come out of shutdown, and are enabled only when the magnitude of V_{ex} exceeds approximately -3V.

High Data Rates

The MAX3221E/MAX3223E/MAX3243E maintain the RS-232 ±5.0V minimum transmitter output voltage even at high data rates. Figure 9 shows a transmitter loopback test circuit. Figure 10 shows a loopback test result at 120kbps, and Figure 11 shows the same test at 250kbps. For Figure 10, all three transmitters were driven simultaneously at 120kbps into RS-232 loads in parallel with 1000pF. For Figure 11, a single transmitter was driven at 250kbps, and all three transmitters were loaded with an RS-232 receiver in parallel with 1000pF.

Mouse Driveability (MAX3243E)

The MAX3243E has been specifically designed to power serial mice while operating from low-voltage power supplies. It has been tested with leading mouse brands such

Table 3. Required Capacitor Values

V _{CC} (V)	C1, C _{BYPASS} (µF)	C2, C3, C4 (µF)
3.0 to 3.6	0.22	0.22
3.15 to 3.6	0.1	0.1
4.5 to 5.5	0.047	0.33
3.0 to 5.5	0.22	1

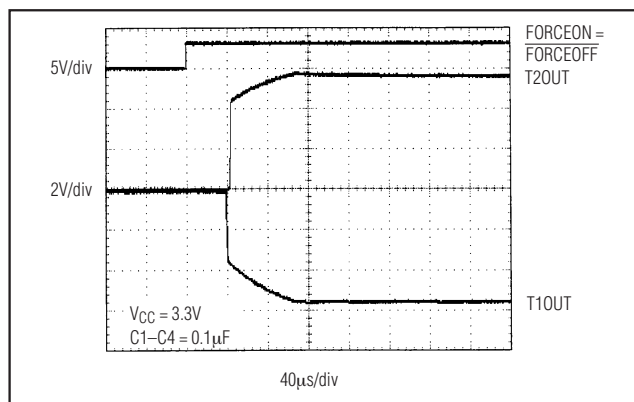

Figure 8. Transmitter Outputs Exiting Shutdown or Powering Up

as Logitech and Microsoft. When tested, the MAX3243E successfully drove all serial mice and met their respective current and voltage requirements. The MAX3243E's regulated dual charge pump ensures the transmitters will supply at least ±5V during worst-case conditions. Figure 12a shows the transmitter outputs under increasing load current. The AutoShutdown feature does not work with a mouse, so FORCEOFF and FORCEON should be connected to V_{CC}. Figure 12b (on the following page) shows a mouse driver test circuit. To achieve mouse driveability with 1µA supply current when the port is inactive, use parts with the AutoShutdown Plus™ feature (such as the MAX3244E and MAX3245E).

AutoShutdown Plus is a trademark of Maxim Integrated Products, Inc.

±15kV ESD-Protected, 1µA, 3.0V to 5.5V, 250kbps, RS-232 Transceivers with AutoShutdown

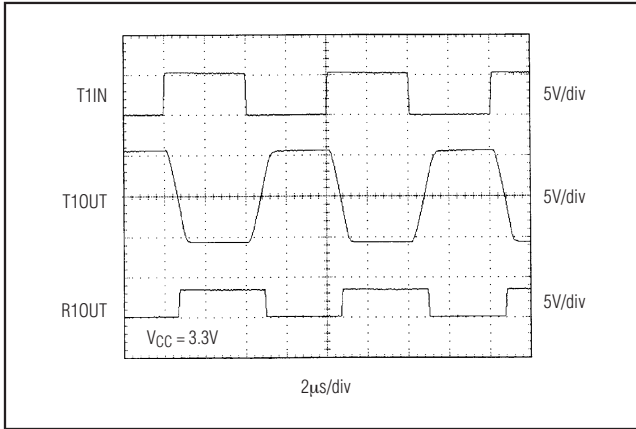

Figure 11. Loopback Test Result at 250kbps

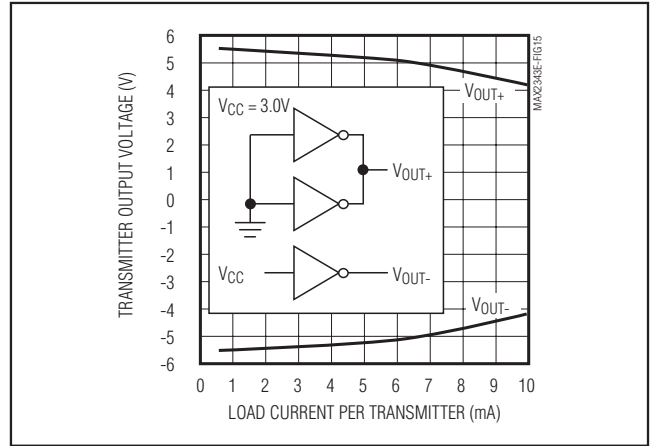

Figure 12a. Transmitter Output Voltage vs. Load Current per Transmitter

Table 5. Logic Family Compatibility with Various Supply Voltages

SYSTEM POWER-SUPPLY VOLTAGE (V)	V _{CC} SUPPLY VOLTAGE (V)	COMPATIBILITY
3.3	3.3	Compatible with all CMOS families.
5	5	Compatible with all TTL and CMOS-logic families.
5	3.3	Compatible with ACT and HCT CMOS, and with TTL. Incompatible with AC, HC, or CD4000 CMOS.

Interconnection with 3V and 5V Logic

The MAX3221E/MAX3223E/MAX3243E can directly interface with various 5V logic families, including ACT and xHCT CMOS. See Table 5 for more information on possible combinations of interconnections.

Ordering Information (continued)

PART	TEMP RANGE	PIN-PACKAGE	PKG CODE
MAX3243ECWI	0°C to +70°C	28 Wide SO	—
MAX3243ECAI	0°C to +70°C	28 SSOP	—
MAX3243ECUI	0°C to +70°C	28 TSSOP	—
MAX3243EEWI	-40°C to +85°C	28 Wide SO	—
MAX3243EEAI	-40°C to +85°C	28 SSOP	—
MAX3243EEUI	-40°C to +85°C	28 TSSOP	—
MAX3243ECTJ	0°C to +70°C	32 Thin QFN-EP (7mm x 7mm)*	T3277-2
MAX3243EETJ	-40°C to +85°C	32 Thin QFN-EP (7mm x 7mm)*	T3277-2

*Exposed paddle.

Chip Information

MAX3221E TRANSISTOR COUNT: 269
 MAX3223E TRANSISTOR COUNT: 339
 MAX3243E TRANSISTOR COUNT: 476
 PROCESS: BICMOS

±15kV ESD-Protected, 1µA, 3.0V to 5.5V, 250kbps, RS-232 Transceivers with AutoShutdown

MAX3221E/MAX3223E/MAX3243E

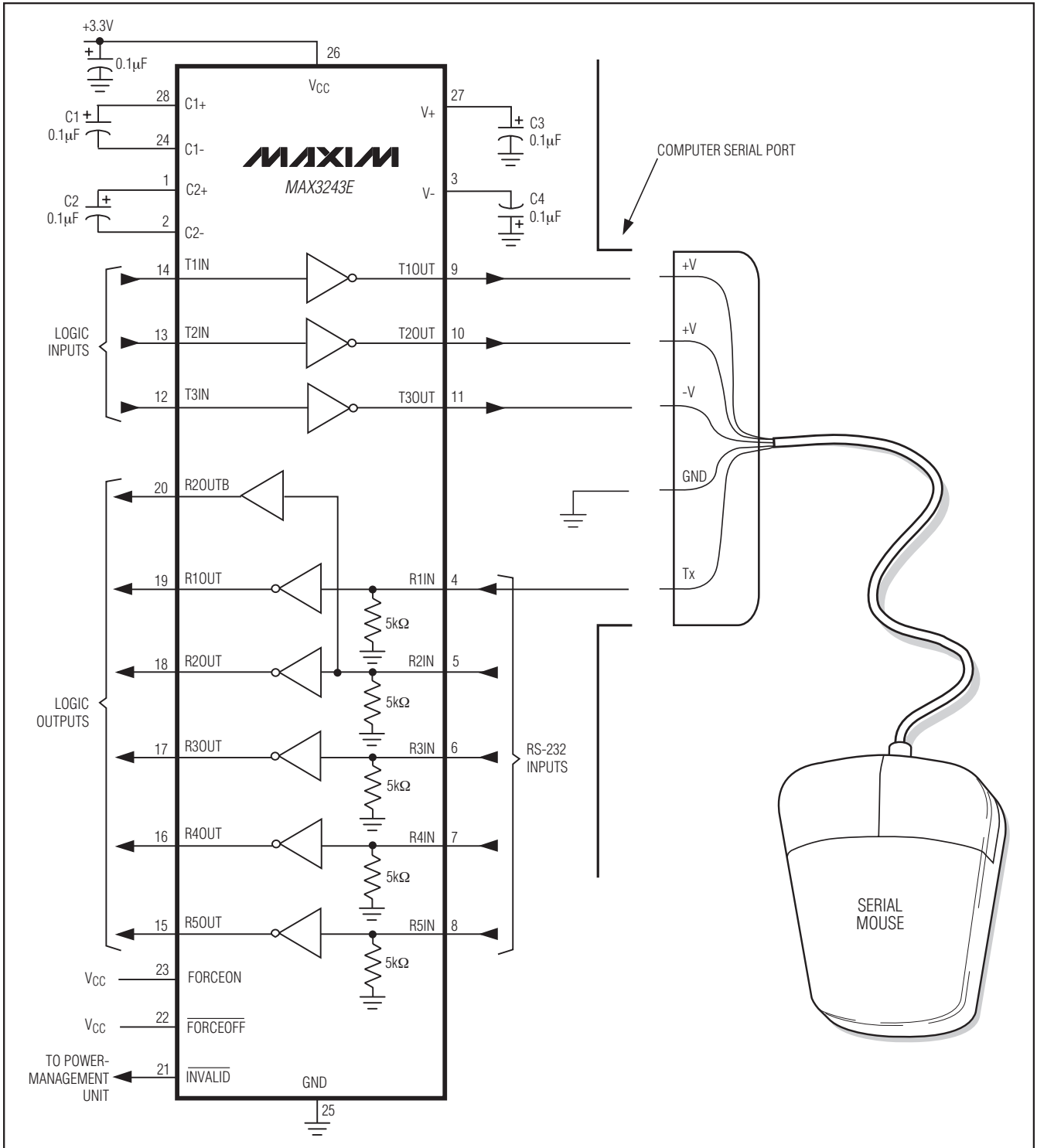
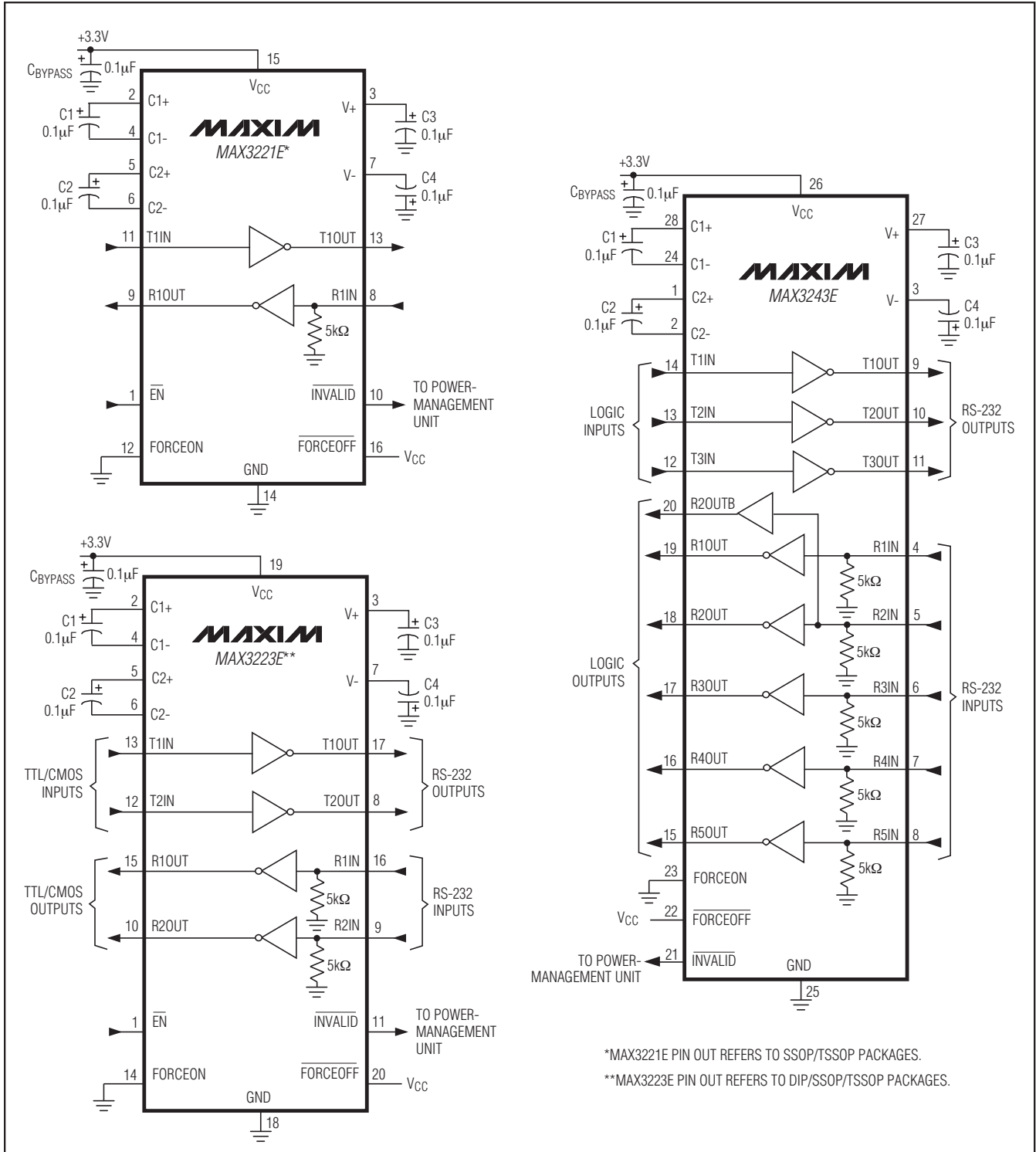

Figure 12b. Mouse Driver Test Circuit

±15kV ESD-Protected, 1µA, 3.0V to 5.5V, 250kbps, RS-232 Transceivers with AutoShutdown

Typical Operating Circuits



±15kV ESD-Protected, 1µA, 3.0V to 5.5V, 250kbps, RS-232 Transceivers with AutoShutdown

Pin Configurations

MAX3221E/MAX3223E/MAX3243E

TOP VIEW

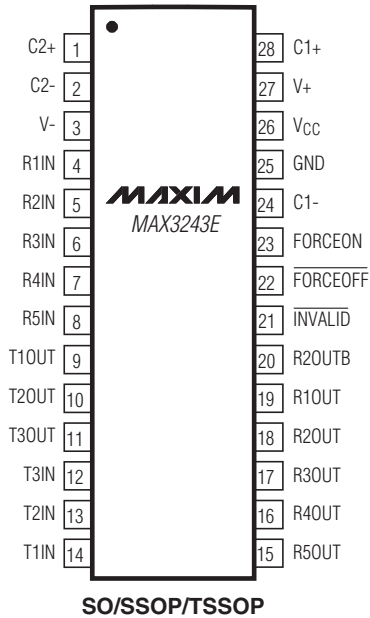
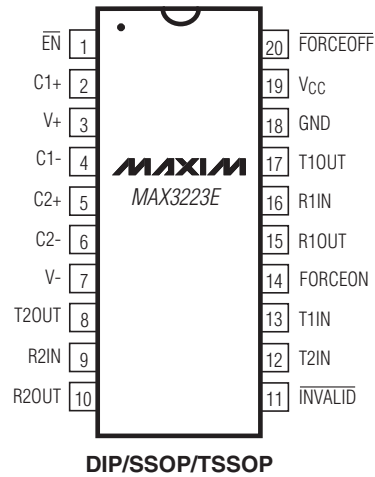
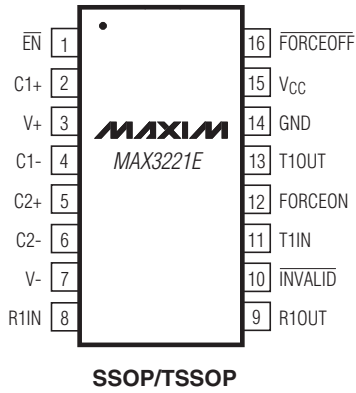

TOP VIEW

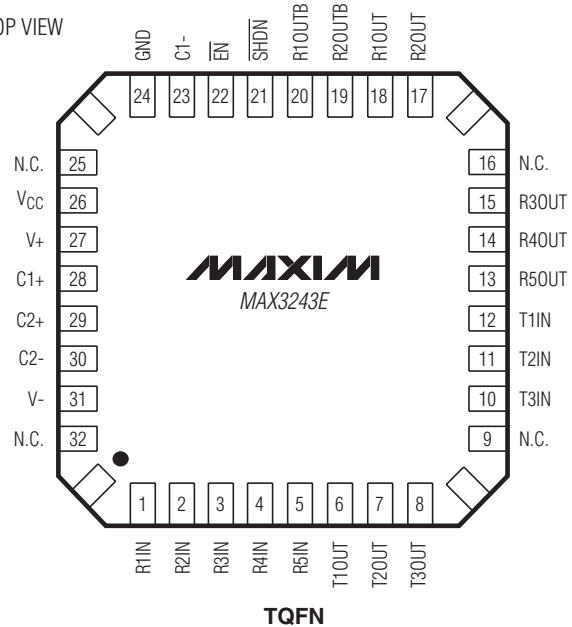

±15kV ESD-Protected, 1µA, 3.0V to 5.5V, 250kbps, RS-232 Transceivers with AutoShutdown

Pin Configurations (continued)

TOP VIEW

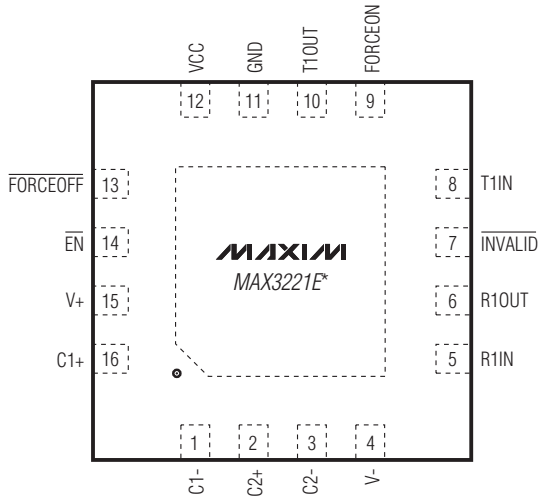

TQFN

* EP = EXPOSED PADDLE

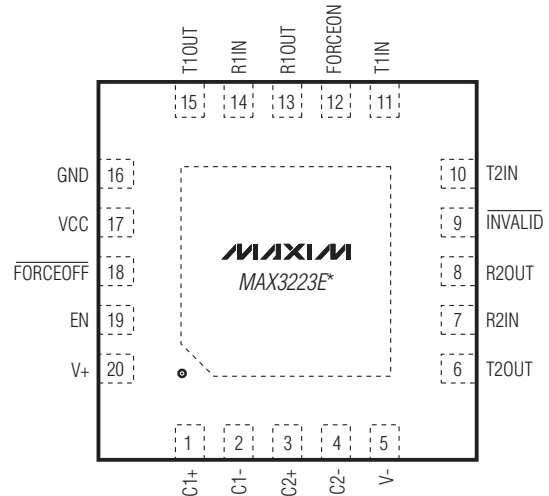

TQFN

* EP = EXPOSED PADDLE

Maxim cannot assume responsibility for use of any circuitry other than circuitry entirely embodied in a Maxim product. No circuit patent licenses are implied. Maxim reserves the right to change the circuitry and specifications without notice at any time.

18 **Maxim Integrated Products, 120 San Gabriel Drive, Sunnyvale, CA 94086 408-737-7600**