

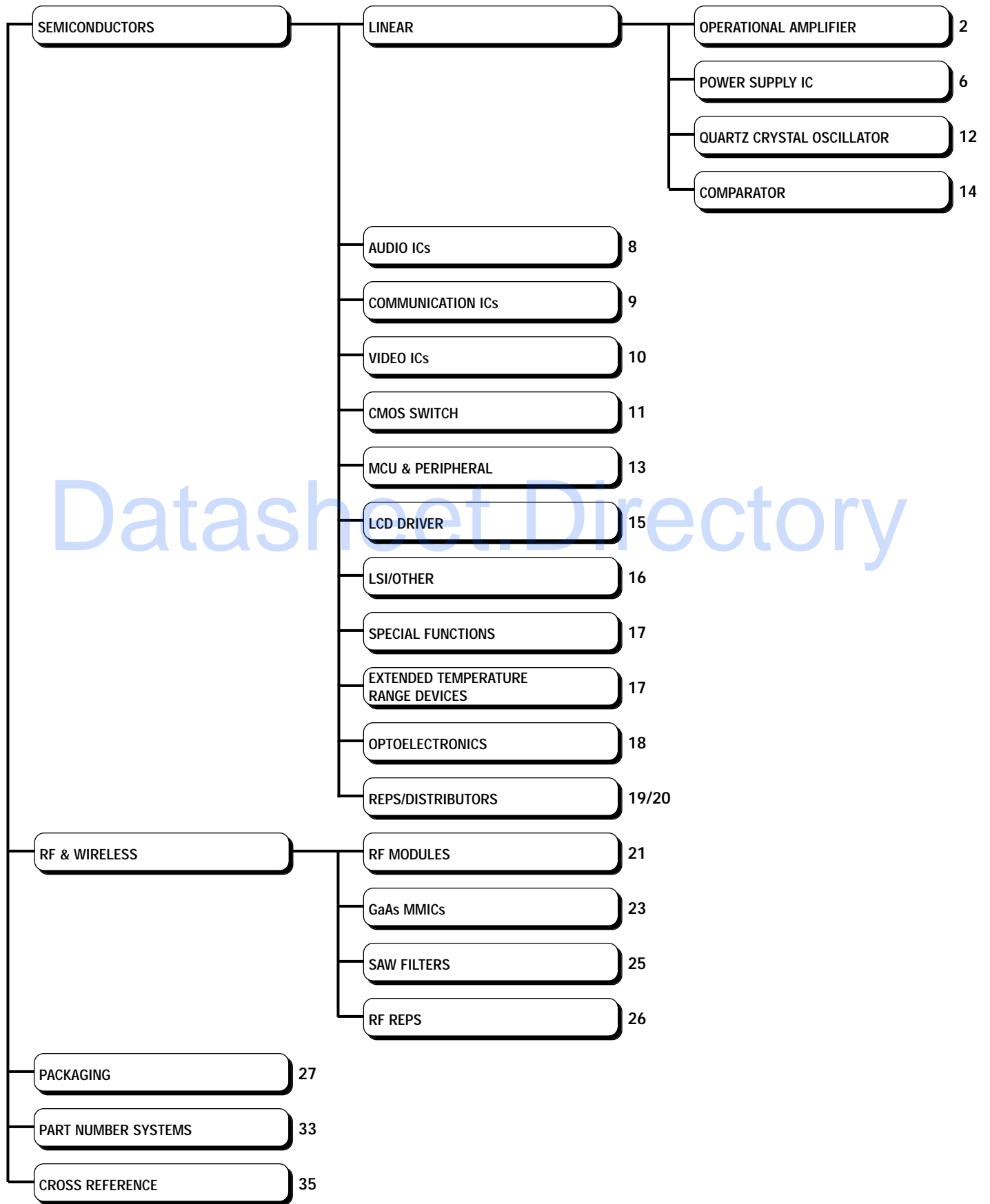

Product Reference Overview



BIPOLAR OPERATIONAL AMPLIFIER

Pwr Supply Inputs	Type	Part Number	Description	V _{IO} Typical Offset Voltage (mV)	V _{IO} Max Offset Voltage (mV)	I _{IO} Typical Offset Current (nA)	I _{IO} Max Offset Current (nA)	I _B Typical Bias Current (nA)	I _B Max Bias Current (nA)	Typical Unity Gain BW (MHz)	Typical Slew Rate (V/μs)	Package Types
HIGH SPEED & WIDE BAND												
2	SINGLE	NJM2136	High speed wide bandwidth Op Amp	1	5	20	200	500	2000	200	45	DMP-8 / SSOP-8
2	DUAL	NJM2137	Ultra Wideband High Slew Rate Dual Op Amp	1	5	20	200	500	2000	200	45	DMP-8 / SSOP-8
2	QUAD	NJM2138	High speed wide bandwidth Op Amp	1	5	20	200	500	2000	200	45	DIP-14 / DMP-14 / SSOP-14
2	HEX	NJM2116	High speed, wide bandwidth Op Amp	1	5	20	200	500	2000	200	45	SSOP-20
HIGH SPEED												
2	SINGLE	NJM318	High slew rate Op Amp	4	10	30	200	150	500	15	70	DIP-8 / DMP-8
2	DUAL	NJM2068	Low Noise Op Amp	0.3	3	5	200	150	1000	5.5	6	DIP-8 / DMP-8 / SSOP-8 / SIP-8
2		NJM4560	Wide bandwidth Op Amp	0.5	6	5	200	40	500	10	4	DIP-8 / DMP-8 / SIP-8
2		NJM4565	Wide bandwidth Op Amp	0.5	3	2	50	50	200	10	4	DIP-8 / DMP-8 / SSOP-8 / SIP-8
2		NJM5532	Low Noise Op Amp	0.5	4	10	150	200	800	10	8	DIP-8 / DMP-8 / SIP-8
PRECISION												
1	DUAL	NJM2119	Single supply low drift Op Amp	0.09	0.45	0.3	7	18	50	1	0.3	DIP-8 / DMP-8
2	SINGLE	NJMOP-07	Instrumentation grade Op Amp	0.06	0.15	0.8	6	2.7	5	-	0.17	DIP-8 / DMP-8
HIGH OUTPUT												
1	DUAL	NJM3414A	High output current Op Amp	2	5	5	100	100	500	1.3	1	DIP-8 / DMP-8 / SSOP-8 / SIP-8
2		NJM4556A	High output current Op Amp	0.5	6	5	60	50	500	8	3	DIP-8 / DMP-8 / SIP-8 / SSOP-8
LOW SATURATION												
2	SINGLE	NJM2107F	MTP-5 package Op Amp	1	6	5	200	100	500	-	3	MTP-5
2	DUAL	NJM2100	High output voltage Op Amp	1	6	-	-	100	300	12	4	DIP-8 / DMP-8 / SSOP-8 / SIP-8
2		NJM2115	Low operating voltage Op Amp	1	6	-	-	100	300	12	4	DIP-8 / DMP-8 / SSOP-8 / SIP-8
		NJM2140	VSP8 package Op Amp	1	6	10	200	100	300	12	4	VSP-8
2	QUAD	NJM2112	Low operating voltage Op Amp	1	6	-	-	100	300	9	3.2	DIP-14 / DMP-14 / SSOP-14
LOW NOISE												
2	SINGLE	NJM5534	Low Noise Op Amp	0.5	4	20	300	500	1500	10	13	DIP-8 / DMP-8
2	DUAL	NJM2041	Low Noise Op Amp	0.3	3	10	200	200	500	7	3	DIP-8 / DMP-8 / SIP-8
2		NJM2043	Low Noise PreAmp.	0.3	3	10	200	400	1000	14	6	DIP-8 / DMP-8 / SIP-8
2		NJM2068	Low Noise Op Amp	0.3	3	5	200	150	1000	5.5	6	DIP-8 / DMP-8 / SSOP-8 / SIP-8
2		NJM2122	Ultra low noise dual Op Amp	1	6	450	1500	3600	8000	12	2.4	DIP-8 / DMP-8
2		NJM4560	Wide bandwidth Op Amp	0.5	6	5	200	40	500	10	4	DIP-8 / DMP-8 / SIP-8
2		NJM4562	Decompensated wide bandwidth Op Amp	0.5	6	5	200	100	500	-	-	DIP-8 / DMP-8 / SIP-8
2		NJM4565	Wide bandwidth Op Amp	0.5	3	2	50	50	200	10	4	DIP-8 / DMP-8 / SSOP-8 / SIP-8
2		NJM5532	Low Noise Op Amp	0.5	4	10	150	200	800	10	8	DIP-8 / DMP-8 / SIP-8
2	QUAD	NJM2060	Op Amp (4560 x 2)	0.5	6	5	200	40	500	10	4	DIP-14 / DMP-14 / SSOP-14

BIPOLAR OPERATIONAL AMPLIFIER (cont.)

Pwr Supply Inputs	Type	Part Number	Description	V _{IO} Typical Offset Voltage (mV)	V _{IO} Max Offset Voltage (mV)	I _{IO} Typical Offset Current (nA)	I _{IO} Max Offset Current (nA)	I _B Typical Bias Current (nA)	I _B Max Bias Current (nA)	Typical Unity Gain BW (MHz)	Typical Slew Rate (V/μs)	Package Types
LOW POWER												
2	DUAL	NJM2132	Low power dual Op Amp	2.5	5	5	20	20	100	1.8	2.1	DIP-8 / DMP-8 / SSOP-8 / SIP-8
2	SINGLE	NJM4250	μ-Power Programmable Op Amp	-	6	-	20	-	75	-	-	DIP-8 / DMP-8 / SSOP-8
2		NJM2130F	Low power Op Amp	1	5	1	80	15	250	-	0.5	MTP-5
2	DUAL	NJM022	Low power Op Amp	1	5	1	80	15	250	-	0.5	DIP-8 / DMP-8 / SSOP-8 / SIP-8
2		NJM022B	Low power Op Amp	1	5	1	80	20	250	-	1	DIP-8 / DMP-8 / SSOP-8 / SIP-8
LOW DISTORTION												
1	DUAL	NJM3404A	Single supply low distortion Op Amp	2	5	5	50	70	200	1.2	1.2	DIP-8 / DMP-8 / SSOP-8 / SIP-8
1	QUAD	NJM3403A	Single supply low distortion Op Amp	2	5	5	50	70	200	1.2	1.2	DIP-14 / DMP-14 / SSOP-14
GENERAL												
1	DUAL	NJM2143	Single supply low power Op Amp	-	7	-	50	-	250	0.6	0.5	VSP-8
1		NJM2904	Single supply low power Op Amp	2	7	5	50	25	250	0.2	0.5	DIP-8 / DMP-8 / SSOP-8 / SIP-8
1	QUAD	NJM324	Single supply low power Op Amp	2	7	5	50	20	250	-	-	DIP-14 / DMP-14 / SSOP-14
1		NJM2902	Single supply low power Op Amp	2	10	5	50	20	500	0.5	0.5	DIP-14 / DMP-14 / SSOP-14
2	SINGLE	NJM741	General purpose Op Amp	2	6	5	200	30	500	-	0.5	DIP-8 / DMP-8 / SSOP-8
2	DUAL	NJM1458	Dual Op Amp (741 x 2)	-	6	-	200	-	500	-	0.5	VSP-8
		NJM2141	Dual Op Amp (741 x 2)	2	6	5	200	30	500	8	3	DIP-8 / DMP-8
2		NJM4558	High gain Op Amp	0.5	6	5	200	25	500	3	1	DIP-8 / DMP-8 / SIP-8 / SSOP-8
2		NJM4559	High performance Op Amp	0.5	6	5	200	25	500	6	2	DIP-8 / DMP-8 / SIP-8 / SSOP-8
2	QUAD	NJM2058	Op Amp (4558 x 2)	0.5	6	5	200	20	500	3	1	DIP-14 / DMP-14 / SSOP-14
2		NJM2059	Op Amp (4559 x 2)	0.5	6	5	200	20	500	6	2	DIP-14 / DMP-14 / SSOP-14
2		NJM4741	General purpose Op Amp (741 x 4)	1	5	30	50	100	300	-	1.6	DIP-14 / DMP-14 / SSOP-14
2	HEX	NJM2097	Hex Op Amp	0.5	6	20	200	120	600	10	5	DMP-24
FET INPUT												
2	DUAL	NJM062	Low power JFET input Op Amp	3	15	1pA	200pA	2pA	400pA	1	3.5	DIP-8 / DMP-8 / SSOP-8 / SIP-8
2		NJM072	J-FET input Op Amp	3	10	5	50	30	200	3.0 /ft	20	DIP-8 / DMP-8 / SIP-8
2		NJM072B	J-FET input Op Amp	3	10	5 pA	50pA	30pA	200pA	3.0 /ft	13	DIP-8 / DMP-8 / SIP-8 / SSOP-8
2		NJM082	J-FET input Op Amp	3	15	5	200	30	400	3.0 /ft	20	DIP-8 / DMP-8 / SIP-8
2		NJM082B	J-FET input Op Amp	5	15	5 pA	200pA	30pA	400pA	5.0 /ft	13	DIP-8 / DMP-8 / SSOP-8 / SIP-8
2		NJM353	Wide bandwidth J-FET input Op Amp	5	10	25pA	100pA	50pA	200pA	4	13	DIP-8 / DMP-8
2		NJM2082	High slew rate J-FET input Op Amp	2	10	5	200	30	400	5	20	DIP-8 / DMP-8 / SSOP-8 / SIP-8

BIPOLAR OPERATIONAL AMPLIFIER (cont.)

Pwr Supply Inputs	Type	Part Number	Description	V _{IO} Typical Offset Voltage (mV)	V _{IO} Max Offset Voltage (mV)	I _{IO} Typical Offset Current (nA)	I _{IO} Max Offset Current (nA)	I _B Typical Bias Current (nA)	I _B Max Bias Current (nA)	Typical Unity Gain BW (MHz)	Typical Slew Rate (V/μs)	Package Types
FET INPUT (cont.)												
2	DUAL	NJM2162	J-FET input Op Amp	5	15	1pA	200pA	2pA	400pA	3	10	DIP / DMP / SIP / SSOP
2	QUAD	NJM064	Low power JFET input Op Amp	3	15	1pA	200pA	2pA	400pA	1	3.5	DIP-14 / DMP-14 / SSOP-14
2		NJM074	J-FET input Op Amp	3	10	5pA	50pA	30pA	200pA	3	13	DIP-14 / DMP-14 / SSOP-14
2		NJM084	J-FET input Op Amp	5	15	5pA	200pA	30pA	400pA	3	13	DIP-14 / DMP-14 / SSOP-14
2		NJM2164	Low power JFET input Op Amp	5	15	1pA	200pA	2pA	400pA	3	10	DIP-14 / DMP-14 / SSOP-14
SMALL PACKAGE												
1	SINGLE	NJM2125F	Single Supply	2	7	5	50	25	250	1.2	1.2	MTP5
SWITCH FUNCTION (2-IN, 1-OUT X 1)												
2	SINGLE	NJM2120	Switching Op Amp (2-input, 1-output)	0.8	6	-	-	80	500	7	2.2	DIP-8 / DMP-8 / SIP-8
2		NJM2121	High speed switching Op Amp	0.8	6	-	-	200	1000	14	4	DIP-8 / DMP-8 / SIP-8
1	DUAL	NJM2123	Dual Op Amp with Switch	1	6	10	200	100	300	10	3	DIP-8 / DMP-8 / SSOP-16
HIGH PERFORMANCE												
2	DUAL	NJM2114	High performance low noise Op Amp	0.2	3	10	300	500	1800	13	15	DIP-8 / DMP-8 / SIP-8
2		NJM4580	High performance Op Amp	0.5	3	5	200	100	500	15	5	DIP-8 / DMP-8 / SSOP-8 / EMP-8 / SIP-8
HIGH VOLTAGE												
2	DUAL	NJM2147	Dual High Voltage High Power Op Amp	1	5	1	80	15	250	-	0.5	DMP / DMP-8
TRANS CONDUCTANCE												
2	DUAL	NJM13600	Transconductance Op Amp with diodes & buffers	0.4	5	-	-	0.4	5	2	50	DIP-14 / DMP-14 / SSOP-14
2		NJM13700	Transconductance Op Amp	0.4	4	-	-	0.4	5	2	50	DIP-14 / DMP-14

CMOS OPERATIONAL AMPLIFIER

Pwr Supply Inputs	Type	Part Number	Description	V _{IO} Typical Offset Voltage (mV)	V _{IO} Max Offset Voltage (mV)	I _{IO} Typical Offset Current (pA)	I _{IO} Max Offset Current (pA)	I _B Typical Bias Current (pA)	I _B Max Bias Current (pA)	Typical Unity Gain BW (MHz)	Typical Slew Rate (V/μs)	Package Types	
LOW VOLTAGE OPERATING (C-MOS TYPE)													
1	SINGLE	NJU7001	Low Power Op Amp		10	1	-	1	-	0.1	0.05	DIP-8 / DMP-8 / SSOP-8 DIP-8 / DMP-8 / SSOP-8	
1		NJU7021	Low Power Op Amp		10	1	-	1	-	0.4	0.4	DIP-8 / DMP-8 / SSOP-8	
1		NJU7031	Low Power Op Amp		10	1	-	1	-	1.5	3.5	DIP-8 / DMP-8 / SSOP-8	
1		NJU7051	Low Power & Low Offset		2	1	-	1	-	0.1	0.05	DIP-8 / DMP-8 / SSOP-8	
1		NJU7061	Low Power & Low Offset		2	1	-	-1	-	0.4	0.4	DIP-8 / DMP-8 / SSOP-8	
1		NJU7071	Low Voltage Op Amp		2	1	-	1	-	1	0.5	0.5	DIP-8 / DMP-8 / SSOP-8
1		NJU7011	Low Voltage Tiny Op Amp		10	1	-	1	-	0.2	0.1	MTP5	
1		NJU7012	Low Voltage Tiny Op Amp		10	1	-	1	-	1	1	MTP5	
1		NJU7013	Low Voltage Tiny Op Amp		10	1	-	1	-	1	2.4	MTP5	
1		NJU7091	Low Power Low Offset Tiny Op Amp		2	1	-	1	-	0.2	0.1	MTP-5	
1		NJU7092	Low Power Low Offset Tiny Op Amp		2	1	-	1	-	1	1	MTP-5	
1		NJU7093	Low Power Low Offset Tiny Op Amp		2	1	-	1	-	1	2.4	MTP-5	
1		DUAL	NJU7002	Low Power Op Amp		10	1	-	1	-	0.1	0.05	DIP-8 / DMP-8
1	NJU7022		Low Power Op Amp		10	1	-	1	-	0.4	0.4	DIP-8 / DMP-8	
1	NJU7032		Low Power Op Amp		10	1	-	1	-	1.5	3.5	DIP-8 / DMP-8	
1	NJU7052		Low Power & Low Offset		2	1	-	1	-	0.1	0.05	DIP-8 / DMP-8	
1	NJU7062		Low Power & Low Offset		2	1	-	1	-	0.4	0.4	DIP-8 / DMP-8	
1	NJU7072		Low Voltage Op Amp		2	1	-	1	-	1	1.6	DIP-8 / DMP-8	
1	NJU7014		Low Voltage Op Amp		10	1	-	1	-	0.2	0.1	DIP-8 / DMP-8 / SSOP-8 / VSP-8	
1	NJU7015		Low Voltage Op Amp		10	1	-	1	-	1	1	DIP-8 / DMP-8 / SSOP-8 / VSP-8	
1	NJU7016		Low Voltage Op Amp		10	1	-	1	-	1	2.4	DIP-8 / DMP-8 / SSOP-8 / VSP-8	
1	NJU7094		Low Power Low Offset Dual Op Amp		2	1	-	1	-	0.2	0.1	DIP-8 / DMP-8 SSOP-8 / VSP8	
1	NJU7095	Low Power & Low Offset Dual Op Amp		2	2	-	2	-	1	1	DIP-8 / DMP-8 SSOP-8 / VSP8		
1	NJU7096	Low Power & Low Offset Dual Op Amp		2	1	-	1	-	1	2.4	DIP-8 / DMP-8 SSOP-8 / VSP8		
1	QUAD	NJU7004	Low Power Op Amp		10	1	-	1	-	0.1	0.05	DIP-14 / DMP-14 / SSOP-14	
1		NJU7024	Low Power Op Amp		10	1	-	1	-	0.4	0.4	DIP-14 / DMP-14 / SSOP-14	
1		NJU7034	Low Power Op Amp		10	1	-	1	-	1.5	3.5	DIP-14 / DMP-14 / SSOP-14	
1		NJU7054	Low Power & Low Offset		2	1	-	1	-	0.1	0.05	DIP-14 / DMP-14 SSOP-14	
1		NJU7064	Low Power & Low Offset		2	1	-	1	-	0.4	0.4	DIP-14 / DMP-14 / SSOP-14	
1		NJU7074	Low Voltage Op Amp		2	1	-	1	-	1	1.6	DIP-8 / DMP-8 / SSOP-8	

POWER SUPPLY ICs

SERIES REGULATOR																														
POSITIVE VOLTAGE REGULATOR (3 TERMINAL)																														
Output Voltage [V]	1.0	1.1	1.2	1.5	2.0	2.1	2.5	2.6	2.7	2.9	3	3.2	3.3	3.5	4	4.5	4.8	5	5.2	5.5	6	8	8.5	9	12	15	18	20	24	Max Load Current
Type																														
NJM78L Series								○										○			○	○		○	○	○	○	○	○	100mA
NJM78M Series																		○			○	○		○	○	○	○	○	○	500mA
NJM78 Series																		○			○	○		○	○	○	○	○	○	1.5A
NJM2930 Series																		○				○	○							100mA or 150mA
NJU7200 Series	○	○	○	○		○	○	○	○	○	○	○	○	○	○		○	○		○										40mA
NJU7201 Series			○	○			○		○		○	○		○	○	○		○	○	○										40mA
NJU7202 Series											○		○	○				○												100mA
NJU7221 Series			○	○	○		○		○		○	○		○	○	○		○		○										40mA
NJU7222 Series											○		○					○												100mA
POSITIVE VOLTAGE REGULATOR (3 TERMINAL)																														
Output Voltage [V]											Max Load Current																			
Type	-24	-18	-12	-9	-8	-5	-4	-3	-2																					
NJM79L Series	○	○	○	○	○	○			○																					100mA
NJM79M Series	○	○	○	○	○	○																								500mA
NJM79 Series	○	○	○	○	○	○																								1.5A
NJM7211 Series										○	○	○	○																	40mA
Type	Description																													
SERIES REGULATOR (OTHERS)																														
NJM317F	Adjustable 3-Terminal positive Voltage Regulator (Io = 1.5A MAX)																													
NJM78LR05	Positive Voltage Regulator with Reset Function																													
NJM2370	Low Dropout Voltage Regulator with ON/OFF Function																													
NJM2930	Low Dropout Voltage Regulator																													
NJU7204 Series	2-Output Positive Voltage Regulator, Low Dropout Voltage (Io = 40mA/circuit)																													
NJM7224 Series	2-Output Positive Voltage Regulator, Low Dropout Voltage (Io = 40mA/circuit, Vout = ±2%)																													

POWER SUPPLY ICs (cont.)

Type	Description
DC/DC CONVERTER	
NJM2352	Low Power Switching Regulator
NJM2355	2-Output Switching Regulator Control
NJM2360	DC/DC Converter
NJM2360A	DC/DC Converter (High Precision Type)
NJU7261/62 Series	Switching Regulator, Internal/External Clock Operation
SWITCHING REGULATOR	
NJM2362	Current Mode Flyback PWM Switching Regulator
NJM2368/69	Switching Regulator Control IC for Flyback Type
NJM2375/A	Power Factor Controller
NJM2378/79	Flyback Type Switching Regulator with Sync. Input
NJM3524	Switching Regulator Control
VOLTAGE CONVERTER	
NJU7660 Series	Voltage Converter, $V^* < 10.5V$ (Doubler)
NJ U7662Series	Voltage Converter, $V^* < 22V$ (Doubler)
NJU7670	Voltage Converter, $ V_{IN} - V_{OUT} < 20V$ (Tripler)
POWER SUPPLY (OTHERS)	
NJM431	Adjustable Precision Shunt Regulator ($I_o = 100mA$ MAX)
NJM723	Precision Variable Voltage Regulator ($I_o = 150mA$ MAX)
NJM2146B	Voltage and Current Control IC
NJM2366	Voltage Divider IC for Large LCD Panel
NJ M2380/A	Adjustable Precision Shunt Regulator
NJU7284 Series	Battery Back-up Switcher
NJU7664	Voltage Inverter for Biasing of Gate of GaAs FET

AUDIO SIGNAL ICs

Part Number	Description	Supply Voltage	Package Type
3-D SURROUND			
NJM2177A	Dolby Pro-Logic surround decoder	9 ~ 13 Volts	SDIP-56, QFP-56, QFP-64
NJM2178	SRS 3D sound IC (mono & stereo)	4.7 ~ 13 Volts	SDMP-30 / SDIP-30
NJM2179	SRS 3D sound IC (stereo only)	4.7 ~ 13 Volts	DIP-16 / DMP-16
NJM2180	TruSurround™ 3D Surround Audio Processor	4.7 ~ 13 Volts	SDIP-30 / SDMP-30
NJM2184	SRS A/V Focus speaker elevation audio processor	4.7 ~ 13 Volts	SDIP-28 / SDMP-30, SDIP-30 / SDMP-30
NJM2189	SRS A/V Focus speaker elevation audio processor	4.7 ~ 13 Volts	SDIP-30, SDMP-30
NJM2187	Passive Matrix TruSurround™ 3D Surround Audio Processor	4.7 ~ 13 Volts	SDIP-30 / SDMP-30
NJU25005	Dolby Pro-Logic Surround Processor	5 Volts	QFP-80
NJU25006	Digital Virtual Dolby Pro-Logic Surround Processor	5 Volts	QFP-80
NJU25007	VMAx 3D Virtual Theater Digital Audio Processor	5 Volts	QFP-80
NJU25018	TruSurround Digital Audio Processor with BBE	5 Volts	QFP-80
NJU25019	Spatializer N-2-2 Digital 3D Audio Processor with BBE	5 Volts	QFP-80
NJW1102	Dolby Pro-Logic Surround Decoder	± 5, 9 ~13 Volts	TFO-64
NJW1102A	Dolby Pro-Logic Surround Decoder	± 5, 9 ~13 Volts	SDIP-56, TQFP-64
NJW1103	Dolby Pro-Logic Surround Decoder with Digital Delay	9, 5 Volts	QFP-80
NJW1104	Dolby Pro-Logic Surround Decoder with Digital Delay		QFP-80 / QFP-100
SOUND ENHANCEMENT			
NJM2150/A	BBE sound enhancement audio processor	4 ~ 12 Volts	DIP-20, DMP-20, SSOP-20
NJM2152	BBE sound enhancement audio processor	4.5~ 13 Volts	DIP-20, DMP-20, SSOP-20
NJM2153	BBE professional sound enhancement audio processor	±9 ~ ±18 Volts	DIP-20, DMP-20
NOISE REDUCTION			
NJM2063A	Dolby B-type noise reduction processor	1.8 ~ 6 Volts	DIP-16, DMP-16
NJM2065A	Dolby B/C-type noise reduction processor	1.8 ~ 6 Volts	DIP-20, DMP-20
NJM2085	Preamplifier & Dolby B-type noise reduction processor	8 ~ 15 Volts	SDMP-30
NJM2185A	Dolby B-type noise reduction processor	1.8 ~ 3.5 Volts	DMP-16 / SSOP-14
AUDIO POWER AMPLIFIER			
NJM386	Low voltage audio power amplifier	4 ~ 12 Volts	DIP-8, SIP-8, DMP-8
NJM386B	Low voltage audio power amplifier (1W)	4 ~ 18 Volts	DIP-8, SIP-8, DMP-8
NJM2070	Low voltage audio power amplifier	1.8 ~ 15 Volts	DIP-8, DMP-8
NJM2073	Dual low voltage audio power amplifier	1.8 ~ 15 Volts	DIP-8, DMP-8, SIP-9
NJM2076	Dual low voltage audio power amplifier	1 ~ 3 Volts	DIP-8, DMP-8, SIP-9
NJM2096	Dual low voltage audio power amplifier	1 ~ 3 Volts	DIP-8, DMP-8, SIP-9
NJM2128	Pre & power amplifier with ALC	1.8 ~ 7 Volts	DMP-16
NJM2113	Low Voltage Audio Power Amp with Power-Down Mode	2 ~ 16 Volts	DMP-8, DMP-8, SIP-8, SSOP-8
NJM2135	Low Voltage Audio Power Amp with Power-Down Mode	2 ~ 16 Volts	DIP-8 / DMP-8 / SSOP-8 / VSP-8 / SIP-8
NJM2149	Low Voltage Audio Power Amp with Power-Down Mode	2 ~ 16 Volts	DMP-8 / SSOP-8 / VSP-8
NJM2160	Car Audio Boost Amplifier		DIP-16 / DMP-16 / SSOP-16
NJU7081	CMOS Low Voltage Audio Power Amplifier	2.4 ~ 5.5 Volts	DMP-8 / SSOP-8 / VSP-8
NJU7082B	CMOS Dual Low Voltage Audio Power Amplifier	2.4 ~ 5.5 Volts	DMP-8 / SSOP-8
NJW1105	Dual Audio Power Amplifier	4 ~ 12 Volts	DIP-16 / DMP-30
AUDIO IC (OTHERS)			
NJM2110	Monaural mic. Amplifier for video camera	2.7 ~ 5.3 Volts	DMP-8, SSOP-8
NJM2118	Monaural microphone amplifier	2.7 ~ 5.3 Volts	DMP-8, SSOP-8
NJM2127	Audio Filter Amplifier	4.5 ~ 5.5 Volts	DIP-14 / DMP-14 / SSOP-14
NJM2133	Audio Filter Amplifier	4.5 ~ 5.5 Volts	DIP-14 / DMP-14 / SSOP-14
NJM2520	2-Input, 1-Output audio switch	4.75 ~ 13 Volts	DIP-8, DMP-8, SIP-8, SSOP-8
NJM2521	3-Input, 1-Output audio switch	4.75 ~ 13 Volts	DIP-8, DMP-8, SIP-8, SSOP-8

AUDIO SIGNAL ICs (cont.)

Part Number	Description	Supply Voltage	Package Type
AUDIO IC (OTHERS) cont.			
NJM2106	Active bass booster	0.9 ~ 2.5 Volts	DMP-16
NJM2117	RF amplifier for CD player	± 5, 5 Volts	SSOP-20
NJM2035	Stereo modulator	1.0 ~ 3.6 Volts	DIP-14, DMP-14
NJM2067	33V dual pre-amp. with magnetic-head select	3 Volts	DIP-16, DMP-16
NJM2072	Signal level sensor system IC	0.9 ~ 7 Volts	DIP-8, DMP-8
NJU25102	Digital Karaoke Audio Processor	5 Volts	QFP-80
NJU25104	VCD KARAOKE Processor	5 Volts	QFP-80
NJU3401	Graphic Equalizer Controller		QFP-80
NJU3402	Graphic Equalizer Controller For NJU7508		QFP-80
NJU7305	7 band electrical variable resistance for graphic equalizer	7.5 ~ 15 Volts	SDIP-28
NJU7306	11 band electrical variable resistance for graphic equalizer	15 ~ 30 Volts	SDIP-42, SOP-40
NJU7307	11 band electrical variable resistance for graphic equalizer	15 ~ 30 Volts	SDIP-42, SOP-40
NJU7505/07	Band pass filter (5/7ch monaural SCF)	5 Volts	DIP-8 / DMP-8
NJU7508	Band pass filter (11ch monaural SCF)	± 5 Volts	SDIP-14 / DMP-14
NJU7509	High speed band pass filter (11ch stereo SCF)	± 5 Volts	SDIP-14 / DMP-14
NJU9702	Single chip digital delay for surround processors	5 Volts	DIP-24, SOP-24

COMMUNICATIONS & RADIO ICs

Part Number	Description	Note	Package Type
FM IF IC			
NJM2206	Low power narrow band FM IF amplifier	PLL detection	DIP-20, DMP-20
NJM2232A	Low power narrow band FM IF amplifier with RSSI	RSSI dynamic 90db	DMP-24
NJM2292	Low power narrow band FM IF IC with RSSI	Op. supply voltage 1.8 ~ 7V	SSOP-20
NJM2294	FM IF with RSSI output for pager	Op. supply voltage 1.1 ~ 4V	SSOP-16
NJM2295A	FM IF IC for Keyless Entry System	Op. supply voltage 2.7 ~ 7V	SSOP-20
NJM2537	Double Conversion FM IF IC for Pager	Op. supply voltage 1.1 ~ 4V	SSOP-20
NJM3357	Low power narrow band FM IF amplifier		DIP-16, DMP-16
NJM3359	Low power narrow band FM IF amplifier		DIP-18
COMMUNICATION (OTHERS)			
NJM567	Tone Decoder	Freq. range 0.01 ~ 500kHz	DIP-8 / DMP-8
NJM1496	Balanced modulator / demodulator	Freq. Range 0.01 ~ 500kHz	DIP-14, DMP-14, SSOP-14
NJM2105	Speech network	Carrier supression 65db typ.	SIP-9
NJM2203	Full balanced mixer		DIP-16
NJM2204A	Log. Amplifier		DIP-16
NJM2211	FSK demodulator / tone decoder	Freq. Range 0.01 ~ 300kHz	DIP-14, DMP-14
NJM2236/36A	FM front-end		DIP-8, DMP-8, SIP-8
NJM2237	AM / FM Radio		DIP-20
NJM2241	AM / FM Radio with tuning indicator circuit		DMP-24
NJM6104	160MHz Direct in PLL IC for DTS or Communication		DIP-8
NJU5601	POCSAG DECODER for PAGER		SSOP-16
NJW2303	Base Band Interface IC	Op. supply volt. 2.7 ~ 3.3V	QFP-32
NJM2145	Remote Control Interface IC	Op. supply voltage 4.75 ~ 5.25V	DIP-16 / DMP-16
NJM3470/70A	FDD read amplifier system		DIP-18

VIDEO SIGNAL ICs

Part Number	Description	Supply Voltage	Package Type
VIDEO SWITCH (GENERAL PURPOSE TYPE)			
NJM2233B	2-input single video switch	4.75 ~ 13 Volts	DIP-8, DMP-8, SIP-8, SSOP-8
NJM2234	3-input single video switch	4.75 ~ 13 Volts	DIP-8, DMP-8, SIP-8, SSOP-8
NJM2235	3-input single video switch with clamp	4.75 ~ 13 Volts	DIP-8, DMP-8, SIP-8, SSOP-8
NJM2248	3-input video superimposer	4.75 ~ 13 Volts	DIP-8, DMP-8, SIP-8, SSOP-8
NJM2249	3-input video superimposer	4.75 ~ 13 Volts	DIP-8, DMP-8, SIP-8, SSOP-8
NJM2273	3-input video switch with mute	4.75 ~ 13 Volts	SIP-9
NJM2293	4-input 1-mute video switch	4.75 ~ 13 Volts	DIP-16, DMP-16
NJM2533	2-input 1-output video switch	4.75 ~ 13 Volts	DIP-8, DMP-8, SIP-8, SSOP-8
NJM2534	3-input 1-output video switch	4.75 ~ 13 Volts	DIP-8, DMP-8, SIP-8, SSOP-8
NJM2535	3-input 1-output video switch	4.75 ~ 13 Volts	DIP-8, DMP-8, SIP-8, SSOP-8
NJM2503	2-input 1-output & 3-input 1-output video switch	4.75 ~ 13 Volts	DIP-16, DMP-16
NJM2506	2-input 1-output & 3-input 1-output video switch	4.75 ~ 13 Volts	DIP-16, DMP-16, SSOP-16
NJM2508	2-input 1-output & 3-input 1-output video switch	4.75 ~ 13 Volts	DIP-16, DMP-16, SSOP-16
NJM2513	2-input 1-output & 3-input 1-output video switch	4.75 ~ 13 Volts	DIP-16, DMP-16
NJM2523	3-input 1-output & 2-input 1-output video switch	4.75 ~ 13 Volts	DIP-16, DMP-16
NJM2283	2-input 3ch video switch	4.75 ~ 13 Volts	DIP-16, DMP-16, SSOP-16
NJM2284	2-input 3ch video switch	4.75 ~ 13 Volts	DIP-16, DMP-16, SSOP-16
NJM2285	2-input 3ch video switch	4.75 ~ 13 Volts	DIP-16, DMP-16, SSOP-16
NJM2286	2-input 3ch video switch	4.75 ~ 13 Volts	DIP-16, DMP-16
NJM2243	3-input single video switch with 75 Ω driver	9 ~ 13 Volts	DIP-8, DMP-8, SIP-8
NJM2244	3-input single video switch with 75 Ω driver & clamp	4.75 ~ 13 Volts	DIP-8, DMP-8, SIP-8
NJM2263	3-input video superimposer with 75 Ω driver	4.75 ~ 13 Volts	DIP-8, DMP-8, SIP-8
NJM2264	3-input video superimposer with 75 Ω driver	4.75 ~ 13 Volts	DIP-8, DMP-8, SIP-8
NJM2245	3-input single video switch with 6db amplifier	8.5 ~ 13 Volts	DIP-8, DMP-8, SIP-8
NJM2246	3-input single video switch with 6db amplifier & clamp	4.75 ~ 13 Volts	DIP-8, DMP-8, SIP-8
NJM2265	3-input video superimposer with 6db amplifier	4.75 ~ 13 Volts	DIP-8, DMP-8, SIP-8
NJM2266	3-input video superimposer with 6db amplifier	4.75 ~ 13 Volts	DIP-8, DMP-8, SIP-8
VIDEO SWITCH (ASSP TYPE)			
NJM2223	Quad video signal switch with 8db amplifier	12 Volts	DMP-16
NJM2262	2-input video superimposer	4.7 ~ 5.3 Volts	DMP-16
NJM2279	3-input 2-output video switch for audio	9 ~ 12 Volts (±4.5 ~ ±6V)	DIP-14, DMP-14
NJM2296	5-input, 3-output video switch	±4 ~ ±6.5 Volts	DIP-16, DMP-16
NJM2509	Video superimposer with Y - C mixer	4.5 ~ 5.1 Volts	SSOP-8
VIDEO IC (OTHERS)			
NJM592	Video amplifier	±3 ~ ±8V	DIP-8/14, DMP-8/14, SSOP-8/14
NJM1372A	RF modulator for NTSC color TV (3.58MHz)	4.75 ~ 5.25 Volts	DIP-14
NJM2208	RF modulator with sound signals	4.75 ~ 5.25 Volts	DIP-16
NJM2129/45	Interface IC for remote control	4.75 ~ 15 Volts	DIP-14, DMP-14
NJM2207	Superimposer IC for NTSC color TV (3.58MHz)	4.75 ~ 13 Volts	DIP-14, DMP-14, ZIP-16
NJM2209	Video picture enhancer	4.75 ~ 5.5 Volts	SIP-9, DMP-14
NJM2210	Video noise reducer	4.75 ~ 5.3 Volts	DIP-8, DMP-8
NJM2214	Video on-screen display	4.75 ~ 5.3 Volts	SDIP-22, DMP-22
NJM2217	Video superimposer with AFC circuit	4.75 ~ 5.3 Volts	DIP-22, SDIP-22
NJM2218	NTSC-M/PAL converter	4.75 ~ 5.5 Volts	DIP-18
NJM2220/30	Video sync. signal detector	4.75 ~ 10 Volts	DMP-8, SIP-9
NJM2224	Video noise reducer	4.75 ~ 5.25 Volts	DMP-8, SIP-9
NJM2225	Video camera auto-iris driver	5 ~ 9 Volts	DMP-16, ZIP-16, SSOP-16
NJM2228	Video subcarrier signal doubler / tripler	5 Volts	DIP-8, DMP-8, SIP-8

VIDEO SIGNAL ICs (cont.)

Part Number	Description	Supply Voltage	Package Type
VIDEO IC (OTHERS) (cont.)			
NJM2229	Video sync. signal detector with AFC circuit	4.7 ~ 5.3 Volts	DIP-16, ZIP-16
NJM2238	Video subcarrier signal tripler	5 Volts	DIP-8, DMP-8, SIP-8
NJM2240	Video subcarrier signal quadrupler	5 Volts	DIP-8, DMP-8, SIP-9
NJM2247A/47B	Video color superimposer	5 ~ 13 Volts	DMP-20
NJM2252	On screen display mixer IC	8.6 ~ 9.4 Volts	SDIP-20
NJM2255	Chroma signal hue tint controller	4.7 ~ 5.3 Volts	DIP-8
NJM2256	Video color superimposer	5 Volts	DMP-20
NJM2257	Video sync. signal detector with AFC circuit	4.7 ~ 5.3 Volts	DIP-16, DMP-16
NJM2258	Video equalizer	5 Volts	SDIP-22
NJM2267	Dual video amp with 6db amp & 75 Ω driver	5 Volts	DIP-8, DMP-8, SSOP-8
NJM2268	Dual video amp with 6db amp & 75 Ω driver	5 Volts	DIP-8, DMP-8, SSOP-8
NJM2298	AV Switch Amplifier	4.5 ~ 5.5V	DMP-24
NJM2538	Video amplifier with 75 Ω driver	V+1=4.5 ~ 5.3V V+2=2.7 ~ 5.3V	SSOP-20
NJW1103	Signal Processor For Color TFT	4.5 ~ 5.5V	

CMOS ANALOG SWITCH

Part Number	Description	Supply Voltage	Package Type
ANALOG SWITCH			
NJU201A	Quad SPST analog switch	44V	DIP-16, DMP-16
NJU211	Quad SPST analog switch	40V	DIP-16, DMP-16
NJU7301	Quad SPST analog switch	44V	DIP-16, DMP-16
NJU7304	Analog multiplexer with 8-channel sample & hold	20V	DIP-16
NJU7311A	X2 Hex, X1 Dual channel multiplexer	34V	SDIP-28, DMP-30
NJU7312A	X3 Quad, X2 Dual channel multiplexer	34V	SDIP-28, DMP-30
NJU7313A	X2 Quad, X4 Dual channel multiplexer	34V	SDIP-28, DMP-30
NJU7314	X2 Hex, X1 Dual channel multiplexer	34V	
NJU7315	X3 Quad, X2 Dual channel multiplexer	34V	
NJU7316	X2 Quad, X4 Dual channel multiplexer	34V	
NJU4051B	8-channel analog multiplexer / demultiplexer	20V	DIP-16, DMP-16, SSOP-16
NJU4052B	Differential 4-ch. Analog multiplexer / demultiplexer	20V	DIP-16, DMP-16, SSOP-16
NJU4053B	Differential 2-ch. Analog multiplexer / demultiplexer	20V	DIP-16, DMP-16, SSOP-16
NJU4066B	Quad bilateral switch	20V	DIP-14, DMP-14, SSOP-14
NJU7370	3 x 32 analog cross point switch	6V (Logic), 11V (switch)	QFP-64

QUARTZ CRYSTAL OSCILLATION ICs

Part Number	Description	Package Type
FUNDAMENTAL		
NJU6328 Series	f_{\max} <24MHz, IOL <1mA, Tri-state buffer	CHIP / EMP-8 / vsp-8
NJU6321 Series	f_{\max} <50MHz, IOL <4mA, Tri-state buffer	CHIP , EMP-8
NJU6323 Series	f_{\max} <50MHz, IOL <4mA, Tri-state buffer	CHIP , EMP-8
NJU6324 Series	f_{\max} <50MHz, IOL <4mA, Tri-state buffer	CHIP , EMP-8
NJU6361A	f_{\max} <50MHz, IOL <4mA, Inverter output	CHIP , EMP-8
NJU6318 Series	f_{\max} <50MHz, IOL <16mA, Tri-state buffer	CHIP , EMP-8
NJU6319 Series	f_{\max} <50MHz, IOL <16mA, Tri-state buffer	CHIP , EMP-8
NJU6322 Series	f_{\max} <50MHz, IOL <16mA, Tri-state buffer	CHIP , EMP-8
NJU6329 Series	f_{\max} <50MHz, IOL <16mA, Tri-state buffer	CHIP , EMP-8
3RD OVER TONE		
NJU6339 Series	f_{\max} <75MHz, IOL <4mA, Tri-state buffer	CHIP , EMP-8
NJU6374 Series	f_{\max} <75MHz, IOL <4mA, Tri-state buffer	CHIP , EMP-8
NJU6391 Series	f_{\max} <75MHz, IOL <8mA, Tri-state buffer, 3V operation	CHIP , EMP-8
NJU6392 Series	f_{\max} <75MHz, IOL <8mA, Tri-state buffer, 3V operation	CHIP / EMP-8
NJU6330 Series	f_{\max} <75MHz, IOL <16mA, Tri-state buffer	CHIP , EMP-8
NJU6338 Series	f_{\max} <75MHz, IOL <16mA, Tri-state buffer	CHIP , EMP-8
NJU6373 Series	f_{\max} <75MHz, IOL <16mA, Tri-state buffer	CHIP , EMP-8
NJU6375 Series	f_{\max} <50MHz, IOL <24mA / 16mA, Tri-state buffer	CHIP , EMP-8
NJU6333 Series	f_{\max} <75MHz, IOL <24mA, Tri-state buffer	CHIP , EMP-8
OTHERS		
NJU6342 Series	f_{\max} <120MHz, IOL <4mA or <24mA, Tri-state buffer	CHIP , EMP-8

MCU & MICROPROCESSOR PERIPHERALS

Part Number	Description	ROM Size	RAM Size	Package Types
MICRO CONTROLLER				
NJU3101	4Bit Single Chip Tiny Controller	512 x 8bit	16 x 4bit	DIP16 / DMP16
NJU3102	4Bit Single Chip Tiny Controller	1024 x 8bit	32 x 4bit	SDIP22 / SOP22
NJU3501	4Bit Single Chip Micro Controller	512 x 8bit	64 x 4bit	DIP20 / SOP20
NJU3502	4Bit Single Chip Micro Controller	1024 x 8bit	64 x 4bit	SDIP24 / DMP24
NJU3503	4Bit Single Chip Micro Controller	2048 x 8bit	128 x 4bit	SDIP28 / SDMP30
NJU3504	4Bit Single Chip Micro Controller	4096 x 8bit	256 x 4bit	SDIP42 / QFP44
NJU3505	4Bit Single Chip Micro Controller	8912 x 8bit	256 x 4bit	SDIP42 / QFP44

Part Number	Description	Package Type
PERIPHERAL ICs		
NJU6401B	RS232C Line driver receiver X3 driver, X5 receiver	DIP-20 / DMP-20
NJU6402B	RS232C Line driver receiver X3 driver, X3 receiver	DIP-16 / DMP-16
NJU6413	RS232C Line Driver Receiver X2 Driver, X2 Receiver	DIP-16 / SDMP-30
NJU6350	Serial Interface Real Time Clock	VSP-8
NJU6355 Series	Serial interface real time clock for 4-bit CPU	DIP-8 / DMP-8
NJU6356 Series	Serial interface real time clock for 4-bit CPU	DIP-8 / DMP-8
NJU6358 Series	Serial interface real time clock for 4-bit CPU with Wake-Up	DIP-14 / DMP-14 / SSOP-14 / CHIP
NJU6359	Serial Interface Real Time Clock with Wake-Up Output	SSOP-8
NJU3711	8-bit Serial In Parallel Out	DIP-14 / DMP-14
NJU3712	8-bit Serial In Parallel Out with Cascade function	DIP-16 / DMP-16
NJU3713	12-bit Serial In Parallel Out	DIP-18 / SOP-18
NJU3714	12-bit Serial In Parallel Out with Cascade function	DIP-20 / SOP-20
NJU3715	16-bit Serial In Parallel Out	SDIP-22 / SOP-22
NJU3716	16-bit Serial In Parallel Out with Cascade function	SDIP-24 / DMP-24
NJU3718	24-bit Serial In Parallel Out with Cascade function	SDIP-28 / SOP-28
NJU3719	24-bit Serial In Parallel Out	SDIP-30

Part Number	Description	Note	Package Types
RESET ICs			
NJM2078	Voltage detector	Supply Voltage 2.5 ~ 40V	DIP-8 / DMP-8
NJM2102	System reset with watch dog timer	Supply Voltage 5 ~ 15V	DIP-8 / DMP-8 / SIP-8
NJM2103	System Reset	Supply Voltage 5 ~ 15V	DIP-8 / DMP-8 / SIP-8
NJM2405	Voltage detector	Supply Voltage 2.5 ~ 40V	DMP-8

COMPARATOR

Pwr Supply Inputs	Type	Part Number	Description	V _{IO} Typical Offset Voltage (mV)	V _{IO} Max Offset Voltage (mV)	I _{IO} Typical Offset Current (nA)	I _{IO} Max Offset Current (nA)	I _B Typical Bias Current (nA)	I _B Max Bias Current (nA)	Typical Response Time (ns)	Voltage Gain (db)	Package Types
HIGH SPEED												
2	Dual	NJM319	High speed dual comparator	2	8	80	200	250	1000	80	92	DIP / DMP /
2	Single	NJM360	High speed voltage comparator	2	5	500	3000	5000	20000	13	-	DIP / DMP-8
PRECISION												
2	Single	NJM311	Precision voltage comparator	2	7.5	6	50	100	250	200	106	DIP / DMP-8
LOW POWER CONSUMPTION												
1	Quad	NJM2901	Single supply low power quad voltage comparator	2	7	5	50	25	250	1300	106	DIP / DMP / SSOP-14
1	Dual	NJM2903	Single supply low power dual voltage comparator	-	7	-	50	30	250	1500	106	DIP / DMP / SIP-8
1	Dual	NJU7102A	Low power comparator with CMOS output - dual	1.2	12	1	-	1	-	-	-	DIP / DMP-8
1	Quad	NJU7104A	Low power comparator with CMOS output - quad	1.2	12	1	-	1	-	-	-	DIP / DMP-14
1	Dual	NJU7112A	Low power comparator with open drain output - dual	1.4	12	1	-	1	-	-	-	DIP / DMP-8
1	Quad	NJU7114A	Low power comparator with open drain output - quad	1.4	12	1	-	1	-	-	-	DIP / DMP-14
	Single	NJU7141	Low Power Comparator with Open Drain Output	-	10	1	-	1	-	-	-	MTP-5-
OTHERS												
2	Dual	NJM2403	High output current dual voltage comparator	-	10	-	100	40	500	1500	106	DIP / DMP / SIP-8
2	Single	NJM2406F	MTP-5 package comparator	1	7	1	50	20	250	1500	106	MTP-5
1	Dual	NJM2407R	Dual Miniature Comparator	2	7	5	50	25	250	800	106	VSP-8

LCD CONTROLLER/DRIVER

	4 character	8 character	10 character	12 character	14 character
CHARACTER TYPE LCD CONTROLLER DRIVER					
1 Line		NJU6408B NJU6468		NJU6467 NJU6428/29 NJU6469	NJU6520
2Line	NJU6408B NJU6468	NJU6408B NJU6468	NJU6424 NJU6425 NJU6427 NJU6428/29	NJU6428/29 NJU6469 NJU6461 NJU6462	NJU6520
3Line		NJU6424 NJU6425 NJU6427	NJU6424 NJU6425 NJU6427	NJU6406B NJU6466	
4Line		NJU6420B NJU6426	NJU6423B	NJU6406B NJU6466 NJU6465 NJU6475 NJU6426+6407C/CR	
	16 character	20 character	24 character	40 character	80 character
1 Line	NJU6460A NJ U6408B NJU6468 NJU6420B NJU6470	NJU6423B	NJU6406B NJU6469 NJU6461	NJU6423B	NJU6408B+6407C/CRx9 NJU6468+6407C/CRx9
2 Line	NJU6420B NJU6426 NJU6408B+6407C/CR	NJU6423B NJU6408B+6417C NJU6468+6417C	NJU6406B NJU6466 NJU6465 NJU6408B+6407C/CRx2 NJU6468+6407C/CRx2	NJU6426+6417C NJU6408B+6407C/CRx4 NJU6468+6407C/CRx4	
3Line	NJU6463				
4Line	NJU6426+6407C/CR	NJU6426+6417C	NJU6426+6415/16		

	61 SEG	80 SEG	96 SEG	122 SEG	128 SEG	134 SEG	141 SEG	288 SEG
BITMAP TYPE LCD CONTROLLER DRIVER								
16 COM	NJU6450A NJU6452A						NJU6450A+6451A NJU6452A+6453A	
17 COM			NJU6580					
32 COM				NJU6450A+6450A NJU6452A+6452A				
33 COM			NJU6583		NJU6455	NJU6575/A		NJU6455+6455
49 COM		NJU6561						
53 COM		NJU6577						
65 COM						NJU6579		

	80 SEG	104 SEG	120 SEG	128 SEG	160 SEG	200 SEG	240 SEG
SEGMENT TYPE LCD DRIVER							
1/2 Duty	NJU6435D	NJU6432B					
1/3 Duty			NJU6435E/F				
1/4 Duty				NJU6437	NJU6438 NJU6439	NJU6433	NJU6436

IC/LSI (OTHERS)

Type	Description	Note	Package Type
VFD DRIVER			
NJU3421A	VFD Driver (9-segment, 15-digit)		SDIP-42 / QFP-44-A1
NJU3422	VFD Driver (8-segment,8-digit)		SDIP-24
NJU3423	VFD Driver (11-segment,11-digit)	Key Scan Function	QFP-44
DMM			
NJU9201B	3-1/2 DIGIT SINGLE CHIP A/D CONVERTER WITH LCD DRIVER		DIP-40 / DMP-42
NJU9203B	3-1/2 DIGIT SINGLE CHIP A/D CONVERTER WITH LED DRIVER	Display HOLD	DIP-40 / DMP-42
NJU9202B	3-1/2 DIGIT SINGLE CHIP A/D CONVERTER WITH LCD DRIVER		DIP-40 / DMP-42
NJU9204B	3-1/2 DIGIT SINGLE CHIP A/D CONVERTER WITH LED DRIVER	Display HOLD	DIP-40 / DMP-42
NJU9207B	3-1/2 DIGIT SINGLE CHIP DMM LSI		QFP-80
NJU9208	3-1/2 DIGIT SINGLE CHIP DMM LSI		QFP-80
NJU9212	3-1/2 DIGIT SINGLE CHIP DMM LSI	Pocket type	QFP-64 / CHIP
NJU9210C	3-3/4 DIGIT SINGLE CHIP DMM LSI With 42-Segment Bargraph		QFP-100
NJU9252	2-DIGIT SINGLE CHIP A/D CONVERTER	LED Drive	DIP-18
D/A CONVERTER			
NJMDAC-08C	Bipolar 8-bit high speed multiplying D/A converter	Nonlinearity $\pm 0.1\%$ MAX.	
TIMER			
NJM555	Timer	From μ sec order to hour order	DIP-8 / DMP-8 / SSOP-8 / SIP-8
NJM556	Dual timer	From μ sec order to hour order	DIP-14 / DMP-14
V/F,F/V CONVERTER			
NJM415I	V/F,F/V converter	Linearity 0.05% Typ.	DIP-8 / DMP-8
ANALOG MULTIPLIER			
NJM4200	Analog multiplier	Total error $\pm 0.5\%$	DIP-8 / DMP-8

SPECIAL FUNCTIONS

Part Number	Description	Note	Package Type
NJM567	Tone Decoder	Freq. Range 0.01 ~ 500kHz	DIP-8, DMP-8
NJM2078	Voltage detector	Op. Supply voltage 2.5 ~ 40V	DIP-8, DMP-8
NJM2102	System reset with watch dog timer	Op. Supply voltage 5 ~ 15V	DIP-8, DMP-8, SIP-8
NJM2103	System reset with watch dog timer	Op. Supply voltage 5 ~ 15V	DIP-8, DMP-8, SIP-8
NJM2211	FSK demodulator / tone decoder	Freq. Range 0.01 ~ 300kHz	DIP-14, DMP-14
NJM2405	Voltage detector	Op. Supply voltage 2.5 ~ 40V	DMP-8
NJM2606/06A	Low voltage DC motor controller	Op. Supply voltage 1.8 ~ 8V	DIP-8, DMP-8
NJM2611	Servo motor controller	Op. Supply voltage 2.5 ~ 7.5V	DIP-16
NJM2624	Brushless DC motor pre-driver	Op. Supply voltage 4.5 ~ 18V	DIP-16, DMP-16, SSOP-16
NJM3470/70A	Floppy disk read amplifier system	Wide Bandwidth (5MHz@-3dB)	DIP-18
NJW4301	2 Channel Bridge Driver	Op. Supply voltage 4~12V	DIP-16, SDMP-30

Motor Control ICs

Type	Description	Note
DCMOTOR		
NJM2606	DC motor speed control	
NJM2611	Servo motor controller	Op. volt. 3~10V
3- PHASE MOTOR		
NJM2624	3-Phase motor pre-driver	Op. volt. 4.5~18V
ACTUATOR		
NJW4301	2ch BTL BRIDGE DRIVER	Op. volt. 4~12V

Extended Operating Temperature Devices ($T_A = -40^{\circ}\text{C}$ to $+85^{\circ}\text{C}$)

Op Amp		Comparator	Power Supply	Audio	Crystal Oscillator	Special Function
NJMOP-07	NJM324	NJM360	NJM78XX	NJM386	NJU6318	NJM555
NJM022	NJM353	NJM2406F	NJM78LXX	NJM386B	NJU6319	NJM556
NJM022B	NJM741	NJM2901	NJM78MXX	NJM2070	NJU6321	NJM567
NJM062	NJM1458	NJM2403	NJM79XX	NJM2072	NJU6361A	NJM2078
NJM064	NJM2082	NJM2903	NJM79LXX	NJM2073	NJU6322	NJM2102
NJM072	NJM2100	Video	NJM79MXX		NJU6323	NJM2103
NJM082	NJM2107	NJM592	NJM431		NJU6324	NJM2211
NJM072B	NJM2116	NJM2244	NJM2352	CMOS Switch	NJU6329	NJM4151
NJM082B	NJM2902	NJM2245	NJM2360	NJU4051B	NJU6338	Telecom
NJM074	NJM2904	NJM2246	NJM2930	NJU4052B	NJU6339	NJM567
NJM084	NJM3403A		NJU4066B	NJU4053B	NJU6373	NJM221
NJM318	NJM3404A		NJU7201		NJU6374	NJM3357
NJM318	NJM4556		NJU7221		NJU6391	
	NJU7031/34					

OPTOELECTRONIC DEVICES

Part Number	Description	Maximum Rating V_{CC} (V)	Electro-Optical Characteristic			Body Size			Note	Package Types
			V_{CC} (V)	Lc		L (mm)	W (mm)	H (mm)		
				Min. (m)	Typ. (m)					
INFRARED REMOTE CONTROL RECEIVER										
High Sensitivity Type										
NJL51Hxxx	Mold Type, Top View	6.3	4.5~5.5	8	16	7.3	6.2	5.4		C
NJL51Vxxx	Mold Type, Side View					7.3	6.2	5.4		D
NJL55Hxxx	Metal Case Type, Top View					10.2	8.2	11.0		F
NJL56Hxxx	Metal Case Type, Top View					10.2	8.2	15.0		G
NJL57Hxxx	Metal Case Type, Top View					10.2	8.2	8.0		E
Standard Type										
NJL61Hxxx	Mold Type, Top View	6.3	4.5~5.5	8	16	7.3	6.2	5.4		C
NJL61Vxxx	Mold Type, Side View					7.3	6.2	5.4		D
NJL62Hxxx	Metal Case Type, Top View					10.2	8.2	8.0		E
NJL63Hxxx	Metal Case Type, Top View					10.2	8.2	11.0		F
NJL64Hxxx	Metal Case Type, Top View					10.2	8.2	15.0		G
NJL65Vxxx	Metal Case Type, Top View					15.0	8.2	18.5		H

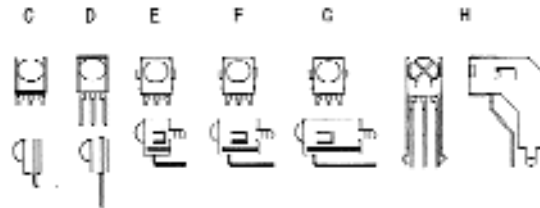

INDEPENDENT SALES REPRESENTATIVES

ALABAMA

MEC
Phone: 256-351-0352

ARIZONA

WESTERN HIGH TECH
Phone: 602-922-6800

ARKANSAS

O & M SALES INC
Phone: 214-361-8876

CALIFORNIA, NORTHERN

PEI ASSOCIATES
Phone: 408-253-1960

CALIFORNIA, SOUTHERN

GOLDEN STATE MARKETING
Phone: 949-452-0990

COLORADO

NJR DIRECT
Phone: 650-961-3901

CONNECTICUT

RAY PERRON COMPANY
Phone: 203-758-5262

DELAWARE

NEXUS TECHNOLOGY
Phone: 301-663-4159

FLORIDA

MEC
Phone: 954-426-8944

GEORGIA

MEC
Phone: 770-623-8524

IDAHO

OAKRIDGE MARKETING
Phone: 801-299-9696

ILLINOIS, NORTHERN

MAX TECHNICAL SALES
Phone: 630-832-0840

ILLINOIS, SOUTHERN

ATS
Phone: 314-291-5003

INDIANA

JUNCTION TECHNOLOGY
Phone: 317-487-9303

IOWA

ATS
Phone: 319-393-8280

KANSAS

ATS
Phone: 913-782-8702

KENTUCKY

JUNCTION TECHNOLOGY
Phone: 317-487-9303

LOUISIANA

O & M SALES INC
Phone: 214-361-8876

MAINE

RAY PERRON COMPANY
Phone: 781-449-6162

MARYLAND

NEXUS TECHNOLOGY
Phone: 301-663-4159

MASSACHUSETTS

RAY PERRON COMPANY
Phone: 781-449-6162

MICHIGAN

MICROTECH SALES
Phone: 734-459-0200

MINNESOTA

HANNA LIND LTD
Phone: 612-931-1242

MISSISSIPPI

MEC
Phone: 256-351-0352

MISSOURI

ATS
Phone: 314-291-5003

MONTANA

OAKRIDGE MARKETING
Phone: 801-299-9696

NEBRASKA

ATS
Phone: 319-393-8280

NEVADA

PEI SALES
Phone: 408-253-1960

NEVADA, CLARK COUNTY

WESTERN HIGH TECH
Phone: 602-922-6800

NEW HAMPSHIRE

RAY PERRON COMPANY
Phone: 603-472-9872

NEW JERSEY

WD SALES
Phone: 201-680-3676

NEW MEXICO

WESTERN HIGH TECH
Phone: 505-884-2256

NEW YORK

WD SALES
Phone: 914-779-8738

NORTH CAROLINA

MEC
Phone: 919-303-5585

NORTH DAKOTA

HANNA LIND LTD
Phone: 612-931-1242

OHIO

SALES PLUS
Phone: 440-942-7811

OKLAHOMA

O & M SALES INC
Phone: 214-361-8876

OREGON

VEN COM SALES
Phone: 503-624-0617

PENNSYLVANIA, EASTERN

WD SALES
Phone: 908-237-1152

PENNSYLVANIA, WESTERN

SALES PLUS
Phone: 440-942-7811

PUERTO RICO

MEC
Phone: 787-746-9897

RHODE ISLAND

RAY PERRON COMPANY
Phone: 617-449-6162

SOUTH CAROLINA

MEC
Phone: 770-623-8524

SOUTH DAKOTA

HANNA LIND LTD
Phone: 612-931-1242

TENNESSEE-WEST

MEC
Phone: 256-351-0352

TENNESSEE-EAST

MEC
Phone: 770-623-8524

TEXAS

O & M SALES INC
Phone: 214-361-8876

TEXAS, EL PASO COUNTY

WESTERN HIGH TECH
Phone: 915-775-9990

UTAH

OAKRIDGE MARKETING
Phone: 801-299-9696

VERMONT

RAY PERRON COMPANY
Phone: 617-449-6162

VIRGINIA

NEXUS TECHNOLOGY
Phone: 301-663-4159

WASHINGTON

VEN COM SALES
Phone: 425-453-1188

WASHINGTON DC

NEXUS TECHNOLOGY
Phone: 301-663-4159

WEST VIRGINIA

SALES PLUS
Phone: 216-942-7811

WISCONSIN

MAX TECHNICAL SALES
Phone: 414-377-9519

WISCONSIN,**EAU CLAIRE COUNTY**

HANNA LIND LTD.
Phone: 612-931-1242

WYOMING

OAKRIDGE MARKETING
Phone: 801-299-9696

INTERNATIONAL**BRAZIL**

INTERTEK COMPONENTS
Phone: 011-55-11-266-2922

CANADA

Canadian Source
Phone: 905-415-1951

CARIBBEAN

MEC/CARIBE
Phone: 787-746-9897

MEXICO

ELECTROCORP, SA De CV
Phone: 011-525-488-07-12

SEMICONDUCTORES

PROFESIONALES SA
(Distributor)

Phone: 011-525-658-6011

DICOPEL, SA De CV (M75)
(Distributor)

Phone: 011-525-705-7422

INTER ELECTRONICS

Phone: 619-476-0577

INTERTRON, SA De CV

MEXICO
Phone: 011-525-341-7772

INTERTRON, SA De CV

GUADALAJARA
Phone: 011-5238-54-02-24

INTERTRON, SA De CV

TIJUANA, BAJA CALIFORNIA
Phone: 619-476-0577

INTERTRON, DEL NORESTE,

SA De CV MONTERREY
Phone: 011-5283-87-03-11

DISTRIBUTORS

ALABAMA

ACTIVE ELECTRONICS
PH# (256) 971-1324
ALL AMERICAN
PH# (256) 837-1555
REPTRON ELECTRONICS
PH# (256) 722-9500

ARIZONA

ACI ELECTRONICS
PH# (520) 293-3035
ALL AMERICAN
PH# (602) 966-0006
ACTIVE ELECTRONICS
PH# (602) 731-4661
JACO ELECTRONICS
PH# (480) 967-1114

ARKANSAS

(CALL NJR DIRECT)

CALIFORNIA-NORTHERN

ACTIVE ELECTRONICS
PH# (408) 434-0369
PH# (916) 782-7882
ALL AMERICAN
PH# (408) 441-1300
IEC ELECTRONICS
PH# (916) 363-6030
JACO ELECTRONICS
PH# (408) 261-6700
REPTRON ELECTRONICS
PH# (408) 453-9933
SMD INCORPORATED
PH# (408) 451-9200

CALIFORNIA-SOUTHERN

ACI ELECTRONICS
PH# (909) 594-1731
PH# (760) 721-1898
ACTIVE ELECTRONICS
PH# (310) 727-1754
PH# (619) 623-2888
PH# (818) 879-1234
PH# (909) 612-0667
ALL AMERICAN
PH# (818) 878-0555
PH# (949) 229-8600
PH# (619) 658-0200
IEC ELECTRONICS
PH# (949) 753-0127
JACO ELECTRONICS
PH# (805) 495-9998
PH# (714) 283-8185
MOUSER ELECTRONICS
PH# (619) 449-2222
REPTRON ELECTRONICS
PH# (949) 450-0300
PH# (818) 991-4597
PH# (619) 505-0036
SMD INCORPORATED
PH# (949) 841-4556

COLORADO

ACI ELECTRONICS
PH# (303) 805-7284
ACTIVE ELECTRONICS
PH# (303) 277-0221
ALL AMERICAN
PH# (303) 422-1701
IEC ELECTRONICS **
PH# (303) 292-5537
PH# (303) 292-6121

CONNECTICUT

ACI ELECTRONICS
PH# (860) 669-3306
ACTIVE ELECTRONICS
PH# (203) 250-1319
REPTRON ELECTRONICS
PH# (203) 265-3134

DELAWARE

(CALL NJR DIRECT)

FLORIDA

ACTIVE ELECTRONICS
PH# (407) 865-9555
PH# (813) 530-1665
PH# (850) 301-0766
ALL AMERICAN **
PH# (407) 261-1304
PH# (954) 429-2800
PH# (305) 621-8282
JACO ELECTRONICS
PH# (954) 425-0304
REPTRON ELECTRONICS**
PH# (813) 854-2351
PH# (954) 735-1112
SMD INCORPORATED
PH# (561) 998-3132

GEORGIA

ACTIVE ELECTRONICS
PH# (770) 447-4767
ALL AMERICAN
PH# (770) 441-7500
REPTRON ELECTRONICS
PH# (770) 446-1300

IDAHO

ACTIVE ELECTRONICS
PH# (208) 376-8080
JACO ELECTRONICS
PH# (425) 481-3372

ILLINOIS

ACI ELECTRONICS
PH# (847) 488-0370
ACTIVE ELECTRONICS
PH# (847) 843-0034
ALL AMERICAN
PH# (847) 303-1995
IEC ELECTRONICS
PH# (847) 843-2040
JACO ELECTRONICS
PH# (847) 884-6620
REPTRON ELECTRONICS
PH# (847) 882-1700

INDIANA

ACTIVE ELECTRONICS
PH# (317) 469-0441

IOWA

(CALL NJR DIRECT)

KANSAS

ACTIVE ELECTRONICS
PH# (913) 338-4400
ALL AMERICAN
PH# (913) 851-5900

KENTUCKY

(CALL NJR DIRECT)

LOUISIANA

(CALL NJR DIRECT)

MAINE

(CALL NJR DIRECT)

MARYLAND

ACTIVE ELECTRONICS
PH# (410) 312-0833
PH# (410) 314-1111
ALL AMERICAN
PH# (410) 309-6262
1-800-426-0420
JACO ELECTRONICS
PH# (410) 995-6620
REPTRON ELECTRONICS
PH# (410) 290-5113

MASSACHUSETTS

ACI ELECTRONICS
PH# (781) 935-7230
ACTIVE ELECTRONICS
PH# (978) 779-3111
ALL AMERICAN
PH# (781) 275-8888
JACO ELECTRONICS
PH# (978) 640-0010
REPTRON ELECTRONICS
PH# (781) 273-2800
SMD INCORPORATED
PH# (781) 932-8421

MICHIGAN

ACTIVE ELECTRONICS
PH# (734) 513-0015
ALL AMERICAN
PH# (734) 464-2202
REPTRON ELECTRONICS
PH# (734) 525-2700

MINNESOTA

ACTIVE ELECTRONICS
PH# (612) 947-0909
ALL AMERICAN
PH# (612) 944-2151
DIGI-KEY ELECTRONICS
PH# (218) 681-6674
** A Non-Franchised
Distributor**
JACO ELECTRONICS
PH# (612) 941-2757
REPTRON ELECTRONICS
PH# (612) 559-0000

MISSISSIPPI

(CALL NJR DIRECT)

MISSOURI

ACTIVE ELECTRONICS
PH# (314) 542-9922

MONTANA

(CALL NJR DIRECT)

NEBRASKA

(CALL NJR DIRECT)

NEVADA

(CALL NJR DIRECT)

NEW HAMPSHIRE

ACTIVE ELECTRONICS
PH# (978) 779-3111
REPTRON ELECTRONICS
PH# (603) 898-6522

NEW JERSEY

ACI ELECTRONICS
PH# (973) 853-3110
ACTIVE ELECTRONICS
PH# (973) 331-1133
PH# (609) 988-1500
MOUSER ELECTRONICS
PH# (973) 328-3322

NEW YORK

ACI ELECTRONICS
PH# (516) 293-6630
ACTIVE ELECTRONICS
PH# (315) 451-4405
PH# (516) 348-3700
PH# (716) 387-9600
PH# (716) 633-7188
PH# (914) 897-3595
ALL AMERICAN
PH# (516) 434-9000
PH# (716) 292-6700
JACO ELECTRONICS **
PH# (516) 273-5500
REPTRON ELECTRONICS
PH# (516) 952-3196

NORTH CAROLINA

ACTIVE ELECTRONICS
PH# (919) 876-0088
PH# (704) 548-9503
JACO ELECTRONICS
PH# (919) 876-7767
REPTRON ELECTRONICS
PH# (919) 870-5189
1-800-659-5190

NORTH DAKOTA

(CALL NJR DIRECT)

OHIO

ACTIVE ELECTRONICS
PH# (440) 446-0061
PH# (937) 427-6090
ALL AMERICAN
PH# (216) 514-0625
REPTRON ELECTRONICS
PH# (440) 349-1415

OKLAHOMA

ACTIVE ELECTRONICS
PH# (918) 492-1500

OREGON

ACI ELECTRONICS
PH# 1-800-352-8586
ACTIVE ELECTRONICS
PH# (503) 603-0866
ALL AMERICAN
PH# (503) 531-3333
IEC ELECTRONICS
PH# (503) 641-1690
JACO ELECTRONICS
PH# (503) 626-1439
REPTRON ELECTRONICS
PH# (503) 629-2082
SHANNON ELECTRONICS
PH# (503) 641-4313

PENNSYLVANIA

ACTIVE ELECTRONICS
PH# (609) 787-1000
ALL AMERICAN
PH# (609) 596-6666
REPTRON ELECTRONICS
PH# (215) 672-6055

RHODE ISLAND

ACTIVE ELECTRONICS
PH# (978) 779-3111

SOUTH CAROLINA

(CALL NJR DIRECT)

TENNESSEE

(CALL NJR DIRECT)

TEXAS

ACI ELECTRONICS
PH# (972) 231-7475
ACTIVE ELECTRONICS
PH# (512) 346-6426
PH# (210) 738-3330
PH# (972) 231-7195
PH# (915) 779-7484
PH# (713) 952-7088
ALL AMERICAN
PH# (972) 231-5300
PH# (512) 335-2280
JACO ELECTRONICS
PH# (972) 234-5565
PH# (512) 835-0220
MOUSER ELECTRONICS **
PH# (817) 483-4422
REPTRON ELECTRONICS
PH# (972) 231-4305
PH# (972) 231-4523

UTAH

ACTIVE ELECTRONICS
PH# (801) 467-9696
ALL AMERICAN
PH# (801) 565-8300
IEC ELECTRONICS
PH# (801) 977-9750

VERMONT

(CALL NJR DIRECT)

VIRGINIA

ACTIVE ELECTRONICS
PH# (804) 984-5022

WASHINGTON

ACI ELECTRONICS
PH# (800) 325-8586
ACTIVE ELECTRONICS
PH# (425) 485-6616
ALL AMERICAN
PH# (425) 806-4800
IEC ELECTRONICS
PH# (425) 455-2727
JACO ELECTRONICS
PH# (425) 481-3372
REPTRON ELECTRONICS
PH# (425) 702-9166
SHANNON ELECTRONICS
PH# (206) 575-8600

WISCONSIN

ACTIVE ELECTRONICS
PH# (414) 792-1142
ALL AMERICAN
PH# (414) 792-0438

INTERNATIONAL

CANADA

ALL AMERICAN
PH# (905) 670-5946
ACTIVE ELECTRONICS **
PH# (514) 694-7710
ELECTRO SONIC
PH# 1-800-56-SONIC

BRAZIL

INTERTEK COMPONENTS
PH# (011)55-11-266-2922

MEXICO

SEMICONDUCTORES
PROFESIONALES SA
PH# (011) 525-658-6011
DICOPEL, SA de cv
PH# (011) 525-705-7422
INTER ELECTRONICS
PH# (619) 476-0577
ELECTROCOP, SA de CV
PH: (011) 525-684-66-26

RF Modules

Type No.	TV System	Input Level	Output Channel	Additional Function	Antenna System
RF MODULATOR					
NJH3031U	NTSC-M	Video 1Vp-p Audio -3.8dBs B+ 5V	USA 3/4CH	Standard (without Control Terminal)	Off-through Switch
NJH3031D	PAL-B		CCIR 3/4CH		
NJH3031D	PAL-D		China 4/5CH		
NJH3041U	NTSC-M		USA 3/4CH	with Control Terminal	
NJH3041D	PAL-D	China 4/5CH			
NJH3032E	PAL-BG/DK	Video 1Vp-p Audio -5dBs B+ 5V	CCIR 30-39CH	Standard (without T.S.G.)	Booster Mixer
NJH3032E	PAL-I/DK				
NJH3032G	PAL-BG				
NJH3032M	PAL-I				
RF MODULATOR VERTICAL TYPE					
NJH3047U	NTSC-M	Video 1Vp-p Audio -3.8dBs B+ 5V	USA 3/4CH	Standard (without Control Terminal)	Off-through Switch
PLL MODULATOR					
NJH3046G	PAL-G	Power Supply (5V/5V/33V) Video 1Vp-p Audio -5dBs	CCIR 21-69CH	I ² C data control with T.S.G.	Booster Mixer
NJH3046M	PAL-I				
NJH3046E	PAL-G/I				
	PAL-G/DK				
	PAL-I/DK				
RF MODULATOR SMALL SIZE					
NJH3048E	PAL-G/I/DK /NTSC-M	Power Supply (5V/5V/33V) Video 1Vp-p Audio -5dBs	CCIR 211-69CH	I ² C data control with T.S.G.	Booster mixer

Type No.	TV System	Input Level	Receiving Channel	Output Level	Output Channel	Antenna System
3 IN 1 MODULE						
NJH3091Uxxx	NTSC-M	Power Supply (5V/5V/33V) Video 1Vp-p Audio -3.8dBs 3wire/I ² C	USA VHF Low 2~B CH VHF High C~W+11 CH UHF W+12~69 CH	Video 1.0Vp-p Audio 480mVrms	USA 3/4 CH	Off-through Switch

Type No.	TV System	Input Level	Receiving Channel	IF Frequency	Note
TV TUNER					
NJH302_Uxxx	NTSC-M	Power Supply (5V/5V/33V) 3wire/I ² C	USA VHF Low 2~B CH VHF High C~W+11 CH UHF W+12~69 CH	VIF 45.75MHz SIF 41.25MHz	World standardized TV tuner
NJH302_Gxxx	PAL		C.C.I.R. 470MHzCATV VHF Low N1~S6 CH VHF High S7~S36 CH UHF S37~E69 CH	VIF 38.9MHz SIF 33.4MHz	
NJH302_Mxxx	PAL		UK UHF E21~E69 CH	VIF 39.5MHz SIF 33.5MHz	
NJH302_Dxxx	PAL		China VHF Low C1~C5 CH VHF High C6~C12 CH UHF C13~C57 CH	VIF 38.0MHz SIF 31.5MHz	

Note: xxx – Semi custom product. Last three digits assigned after approval of specification.

RF Modules (cont.)

TV TUNER NUMBERING SYSTEMS

Example NJH3022U001
 NJH302xxxx

NJH3022xxxx

NJH3022Uxxx

TV tuner

- 1: 470MHz CATV,Phono
- 2: 470MHz CATV,F
- 3: 470MHz CATV,DIN
- 4: 300MHz CATV,Phono
- 5: 300MHz CATV,F
- 6: 300MHz CATV,DIN
- 7: VHF/UHF,Phono
- 8: VHF/UHF,F
- 9: VHF/UHF,DIN

- U: USA
- J: Japan
- B: Australia
- D: China
- E: Europe Multi
- D: China
- G: Germany
- M: U.K.

Dimensions

RF MODULATOR

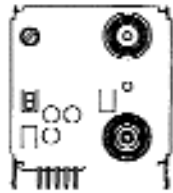

(42) × (44) × (17)

RF MODULATOR VERTICAL TYPE

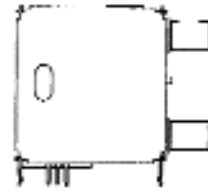

(47) × (44) × (16)

PLL MODULATOR

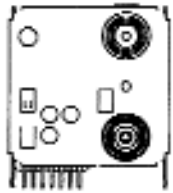

(44) × (44) × (17)

RF MODULATOR Small size

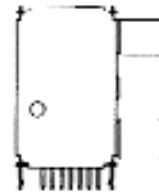

(27) × (41) × (17)

UNIT mm: (W) × (H) × (D)

3in1 MODULE
 Input connector: I

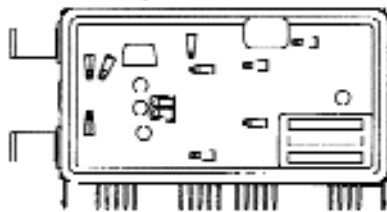

(89) × (44) × (15)

TV TUNER
 Input connector: F

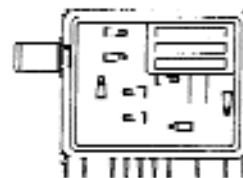

(51) × (42) × (15)

TV TUNER
 Input connector: DIN

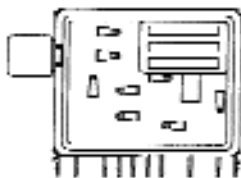

(51) × (42) × (15)

TV TUNER
 Input connector: Phono

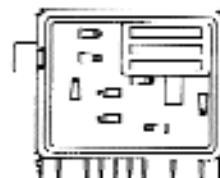

(51) × (42) × (15)

UNIT mm: (W) × (H) × (D)

GaAs MMICs

Type	Description	Insertion Loss Max [dB]	Isolation Min. [dB]	P-1dB Min. [dBm]	Switching Speed Typ. [ns]	Operating Frequency Range	Package Type
GaAs SWITCH IC							
NJG1505	L-Band SPDT Switch Positive Bias type	1.2	33	19	8	100MHz ~ 2.5GHz	VSP8
NJG1506		0.6 @f=1GHz	23	19	15	100MHz ~ 2GHz	
NJG1507		0.8	25	26			
NJG1508		0.6 @f=1GHz	20	19			MTP6
NJG1509		0.8	20	26			
NJG1512		1.2	43	19	8	100MHz ~ 2GHz	SSOP14
NJG1515	Multifunction Switches for TDMA	0.65@TX 0.80@TX	22@TX 30@TX	23@RX 26@RX	120 120	800MHz 1.5GHz	SSOP20-B2

f=1.9GHz

Type	Description	GAIN Min. [dB]	Pacp Max. @Δ f=600KHz [dBc]	GAIN Variable Range Typ. [dB]	Maximum Power Dissipation [mW]	Note	Package Type
GaAs AMPLIFIER							
Power Amplifier							
NJG1301	GaAs Power Amp.	20	-55 @Pout=21dBm	—	600 1000	Suited for PHS Application	SSOP15 EMP14
NJG1302	GaAs Power Amp (Gain Variable Type)	29	-55 @Pout=21dBm	20	600 1000		SSOP14 EMP14
Driver Amplifier							
NJG1307	GaAs Driver Amp. (Gain Variable Type)	29	—	40	300		VSP8
NJG1308	GaAs Driver Amp.	11	-60 Typ. @Pout=8dBm	—	300		MTP6
NJG1309	GaAs Driver Amp. (Positive Power Supply Type)	34	-55 @Pout=21dBm	26	600	Suited for PHS Application	SSOP16-B2
AGC Amplifier							
NJG1101	GaAs Wide Band AGC Amp. (Gain Variable Type)	15.5	-70 Typ. @Pout=10dB	40	300		MTP6
Type	Description	GAIN		NF	Maximum Power Dissipation [mW]	Note	Package Type
Low Noise Amplifier							
NJG1102	Low Noise Amp.	15		1.4	150		MTP6-1
NJG1103	Low Noise Amp.	14 @f=1.5GHz 12 @f=1.9GHz		1.2 @f=1.5GHz 1.4 @f=1.9GHz	150		MTP6-1

RF & WIRELESS

GaAs MMICs (cont.)

$f_{IF}=130\text{MHz}(*240\text{MHz}), P_{LO}=-10\text{dBm}, P_{RF}=-30\text{dBm}$

Type	Description	I Total Typ. [mA]	GC Typ. [dB]	IP3 Typ. [dBm]	NF Typ. [dB]	Application	Package Type
GaAs Mixer IC							
NJG1550 NJG1551	GaAs Mixer IC $f_{RF}=800\sim 900\text{MHz}$	4.5 7.0	14.0 13.0 @ $f_{RF}=820\text{MHz}$	-6.0 -1.0 @ $f_{RF}=820\text{MHz}^*$	5.0 5.0 @ $f_{RF}=820\text{MHz}$	Cellular Phone	MTP6
NJG1552	GaAs Mixer IC $f_{RF}=150\sim 1900\text{MHz}$	4.5	8.0 @ $f_{RF}=1489\text{MHz}$ 5.0 @ $f_{RF}=1900\text{MHz}^*$	-5.0 @ $f_{RF}=1489\text{MHz}^*$ 1.0 @ $f_{RF}=1900\text{MHz}^*$	6.0 @ $f_{RF}=1489\text{MHz}$ 1.0 @ $f_{RF}=1900\text{MHz}^*$	Cellular and Cordless Phone	
NJG1553	GaAs Mixer IC $f_{RF}=150\sim 1900\text{MHz}$	7.0	9.0 @ $f_{RF}=1489\text{MHz}$ 7.0 @ $f_{RF}=1900\text{MHz}^*$	-1.0 @ $f_{RF}=1489\text{MHz}$ 4.0 @ $f_{RF}=1900\text{MHz}^*$	6.0 @ $f_{RF}=1489\text{MHz}$ 6.0 @ $f_{RF}=1900\text{MHz}^*$		

$f=1.9\text{GHz}$

Type	Description	PA-SW			SW-LNA		Application	Package Type	
		I _{dd} Typ. [mA]	GAIN Min. [dB]	P _{acp} Max. @ $\Delta f=600\text{KHz}$ [dBc]	GAIN Variable Range Typ. [dB]	NF Typ. [dB]			I _{dd} Typ. [mA]
GaAs MULTI FUNCTION IC FOR PHS									
NJG1701V	GaAs Multifunction IC (PA+SW+LNA)	160	29	@P _{out} =20dBm	33	2.7	2.8	PHS	SSOP20

SAW FILTERS

Part Number	Application	Center Frequency (MHz)	Pass Band (MHz)	Pass Band Insertion Loss (dB)	Pass Band Ripple (dB)	Rejection Outside of Passband (dB)	VSWR	Max Input (dBm)	Operational Temperature Range (°C)
NSVA497	AMPS TX	836.50	25	4	2	20 (869 - 894.5MHz)	3	20	- 30 to + 85
NSVA498	AMPS RX	881.50	25	4	2	20 (824 - 849MHz)	3	20	- 30 to + 85
NSVA210	ETACS TX	888.50	33	6	2.5	20 (923 - 950MHz)	3	20	- 30 to + 85
NSVA211	ETACS RX	933.50	33	6	2.5	35 (872 - 894MHz)	3	20	- 30 to + 85
NSVA260	NTACS TX	911.50	27	4.5	2	45 (715 - 815MHz)	3	20	- 30 to + 85
NSVA261	NTACS TX	856.50	27	4.0	2	20 (898 - 925MHz)	3	20	- 30 to + 85
NSVA272	GMS TX	902.50	25	5.5	2.5	30 (935 - 960MHz)	3	20	- 20 to + 70
NSVA273	GMS RX	947.50	25	4.5	2.0	20 (890 - 915MHz)	2	20	- 20 to + 70
NSVA276	CT1+	886.00	2.4	3.5	1.5	45 (806 - 844.4 MHz)	2.5	20	-10 to + 60
NSVA277	CT1+	931.00	2.4	3.5	1.5	45 (851 - 886 MHz)	2.5	20	-10 to + 60
NSVA300	CT1+	914.50	2.4	3.5	1.5	45 (834.5 - 872.9MHz)	2.5	20	-10 to + 60
NSVA301	CT1+	959.40	2.4	3.5	1.5	45 (879.5 - 914.5MHz)	2.5	20	-10 to + 60
NSVA371	CT2	912.00	4.0	3.5	1.0	55 (614 - 812MHz)	3.0	20	-10 to + 60
NSVA288	Pager	930.00	4	6	1.7	40 (630 - 910.7MHz)	2	20	- 10 to + 60
NSVA325	Pager	458.00	10	6	2	50 (-35MHz) 40 (-20MHz) 50 (+25MHz)	3	20	- 10 to + 50
NSVA234	PDC1.5G TX	1441.00	24	3.7	2	15 (1477 - 1501MHz)	3	15	- 20 to + 70
NSVA235	PDC1.5G RX	1489.00	24	3.7	2	25 (1477MHz) 10 (1453MHz)	3	15	- 20 to + 70
NSVA352	GPS	1575.42	2	2.5	1.0	40 (1475.42MHz)	2	0	-40 to 85
NSVA278	USA Cordless	903.00	2.0	4.0	1.5	45 (823 - 861MHz)	2.5	20	- 10 to + 60
NSVA279	USA Cordless	927.00	2.0	3.5	1.5	45 (847 - 888.5MHz)	2.5	20	- 10 to + 60
NSVA419	USA Cordless	915.00	26	4.5	2.0	40 (fc-100MHz)	3	20	- 30 to + 85
NSVA274	PHS	1907.00	24	3.5	1.5	20 (+/-100MHz)	3	15	- 20 to + 70

INDEPENDENT SALES REPRESENTATIVES**ALABAMA**

MEC
Phone: 256-351-0352

ARIZONA

WESTERN HIGH TECH
Phone: 602-922-6800

ARKANSAS

O & M SALES INC
Phone: 214-361-8876

**CALIFORNIA, NORTHERN
(No. Nevada)**

PEI ASSOCIATES
Phone: 408-253-1960

CALIFORNIA, SOUTHERN

KSA
Phone: 619-453-5720

COLORADO

ALLIANCE ELECTRONICS
Phone: 303-433-1648

DELAWARE

NEXUS TECHNOLOGY
Phone: 301-663-4159

FLORIDA

MEC
Phone: 954-426-8944

GEORGIA

MEC
Phone: 770-623-8524

ILLINOIS, NORTHERN

MAX TECHNICAL SALES
Phone: 630-832-0840

ILLINOIS, SOUTHERN

ATS
Phone: 314-291-5003

IOWA

ATS
Phone: 319-393-8280

KANSAS

ATS
Phone: 913-782-8702

KENTUCKY

(CALL NJR DIRECT)

LOUISIANA

O & M SALES INC
Phone: 214-361-8876

MARYLAND

NEXUS TECHNOLOGY
Phone: 301-663-4159

MINNESOTA

HANNA LIND LTD
Phone: 612-931-1242

MISSISSIPPI

MEC
Phone: 256-351-0352

MISSOURI

ATS
Phone: 314-291-5003

NEBRASKA

ATS
Phone: 319-393-8280

NEVADA

PEI SALES
Phone: 408-253-1960

NEVADA, CLARK COUNTY

WESTERN HIGH TECH
Phone: 602-922-6800

NEW JERSEY

WD SALES
Phone: 201-680-3676

NEW MEXICO

WESTERN HIGH TECH
Phone: 505-884-2256

NEW YORK

WD SALES
Phone: 716-383-4957

NORTH CAROLINA

MEC
Phone: 919-303-5585

NORTH DAKOTA

HANNA LIND LTD
Phone: 612-931-1242

OHIO

SALES PLUS
Phone: 440-942-7811

OKLAHOMA

O & M SALES INC
Phone: 214-361-8876

PENNSYLVANIA, EASTERN

WD SALES
Phone: 908-237-1152

PUERTO RICO

MEC
Phone: 787-746-9897

SOUTH CAROLINA

MEC
Phone: 770-623-8524

SOUTH DAKOTA

HANNA LIND LTD
Phone: 612-931-1242

TENNESSEE, EAST

MEC
Phone: 770-623-8524

TENNESSEE, WEST

MEC
Phone: 256-351-0352

TEXAS

O & M SALES INC
Phone: 214-361-8876

TEXAS, EL PASO COUNTY

WESTERN HIGH TECH
Phone: 915-775-9990

VIRGINIA

NEXUS TECHNOLOGY
Phone: 301-663-4159

WASHINGTON, D.C.

NEXUS TECHNOLOGY
Phone: 301-663-4159

WISCONSIN

MAX TECHNICAL SALES
Phone: 414-377-9519

INTERNATIONAL**BRAZIL**

INTERTEK COMPONENTS
Phone: 55-11-266-2922

CANADA

Canadian Source
Phone: 905-415-1951

CARIBBEAN

MEC/CARIBE
Phone: 787-746-9897

ITALY

DSPM
TELECOMUNICAZIONI SRL
Phone: -39-02-668-00984

■ PACKAGE OUTLINE TABLE

	Suffix	3Pin	5Pin	8Pin	9Pin	14Pin	16Pin	18Pin	20Pin	22Pin
TO-92	E/F	○	-	-	-	-	-	-	-	-
TO-220F	F	○	-	-	-	-	-	-	-	-
SOT-89	U	○	-	-	-	-	-	-	-	-
MTP-5	F	-	○	-	-	-	-	-	-	-
DMP	D/N	-	-	○	-	○	○	○	○	○
SDMP	L	-	-	-	-	-	-	-	-	○
DMP	M	-	-	○	-	○	○	○	○*2	○
	G	-	-	○	-	-	-	○	○	○
EMP	E	-	-	○	-	○	-	-	-	-
SSOP	V	-	-	○	-	○	○	-	○	-
SIP	L	-	-	○	-	-	-	-	-	-
ZIP	S	-	-	-	-	-	○	-	-	-
QFP	F	-	-	-	-	-	-	-	-	-
VSP	E	-	-	○	-	-	-	-	-	-

	Suffix	24Pin	28Pin	30Pin	40Pin	42Pin	44Pin	56Pin	64Pin	80Pin	100Pin
DIP	D/N	○*3	-	-	○	-	-	-	-	-	-
SDIP	F	○	○	○	-	○	-	○	-	-	-
DMP	M	○	-	○*4	-	○	-	-	-	-	-
SOP	G	○*3	○	-	○	-	-	-	-	-	-
DMP	E	-	-	-	-	-	-	-	-	-	-
SSOP	V	○	-	-	-	-	-	-	-	-	-
SIP	S/L	-	-	-	-	-	-	-	-	-	-
ZIP	S	-	-	-	-	-	-	-	-	-	-
QFP	F	-	-	-	-	-	○	○	○	○	○

*1) Except NJM78L, NJM79L Series

*2) Lead pitch: 0.95mm

*3) These two packages are applied to only NJU9702.

*4) Lead pitch: 1.0mm(SDMP-30)

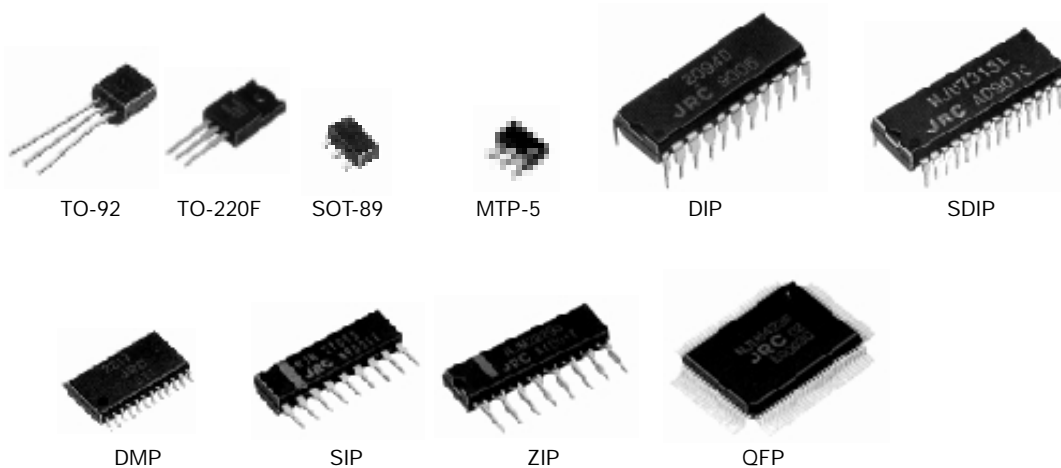

DIP8 (D/N Designation)

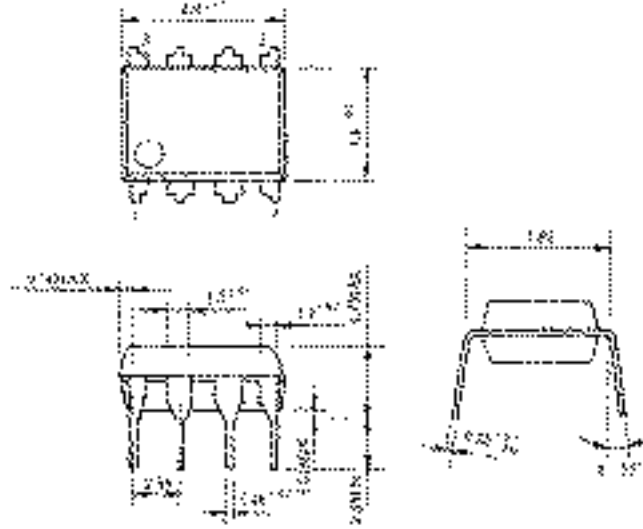

U68120A

DMP8 (M Designation)

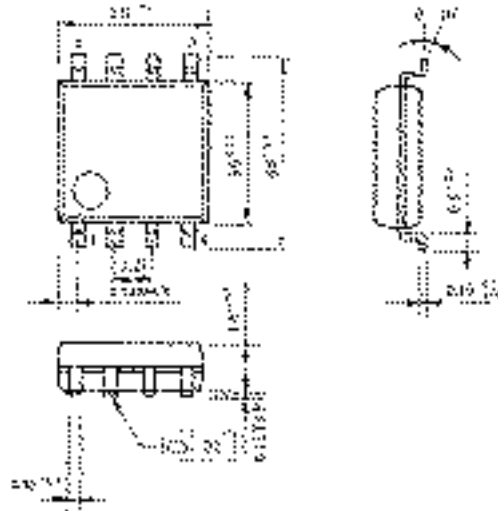

U68120A

ESOP8 (E Designation)

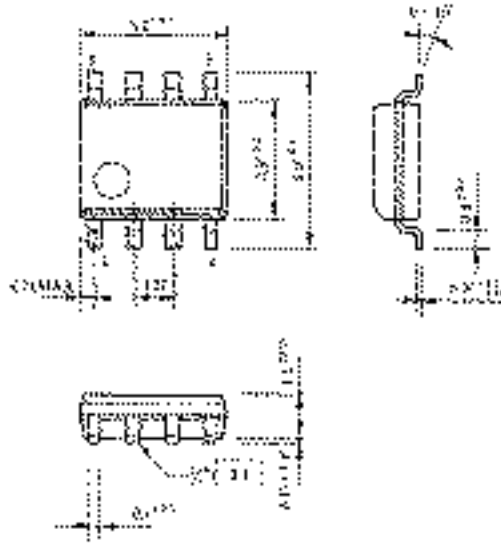

ESOP8

SSOP8 (V Designation)

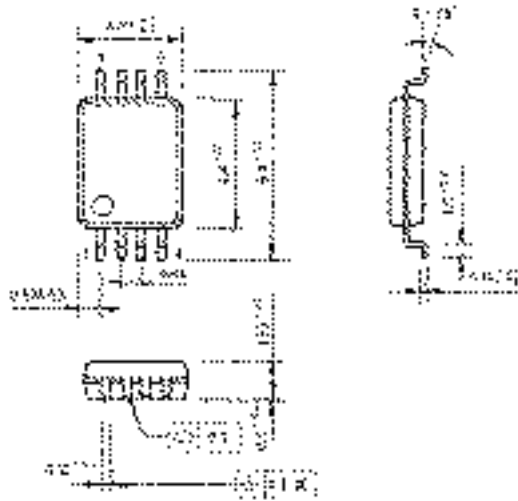

SSOP8

7007-566

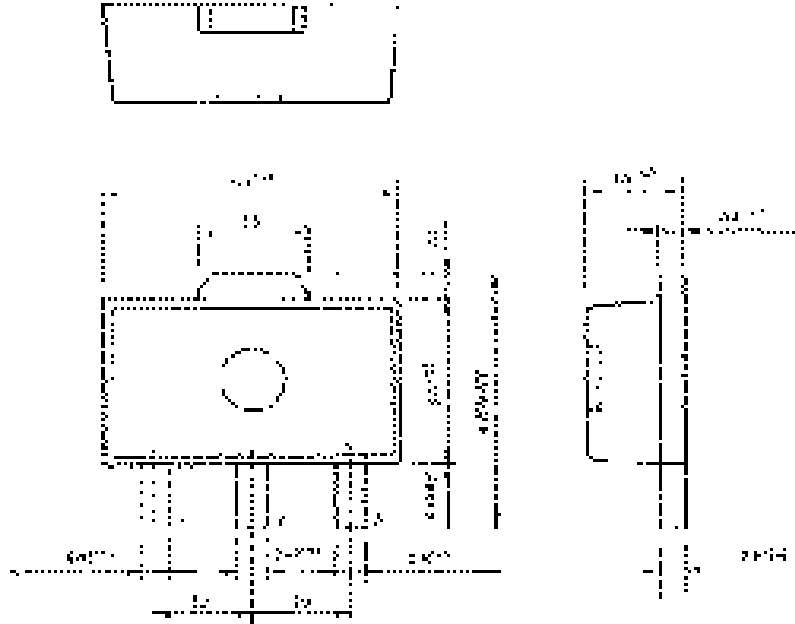

FIG. 100.

7007-567 (F Designation)

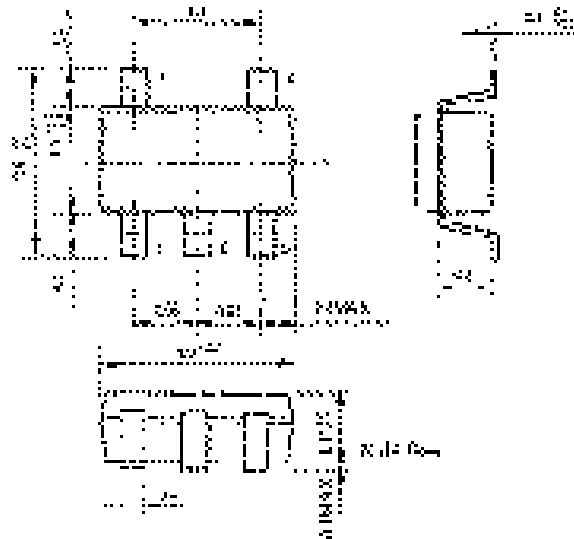
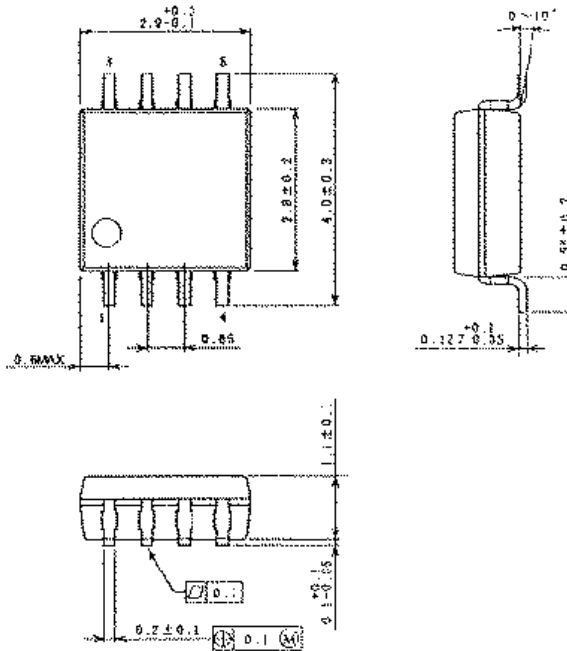

FIG. 101.

VSP8 (R Designation)



- TO-220F Fully Molded Three Terminal Voltage Regulator

NJR's fully molded package, the TO-220F was developed for medium and high power 3 pin voltage regulators. It is fully interchangeable with conventional TO-220 packages with the exception that the radiation fin is resin encapsulated offering the following features:

1. The radiation fin is fully insulated. No need for Teflon washers.
2. In cases where the fin is not attached the fully molded TO-220F offers better heat dissipation.
3. Higher reliability and moisture resistance.

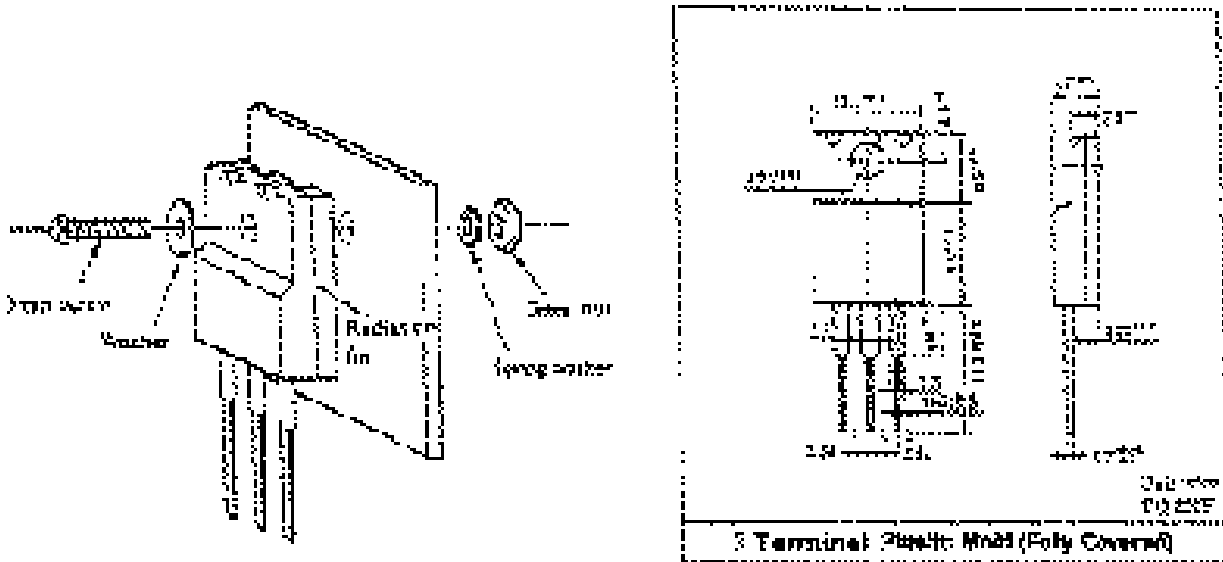

THERMAL CHARACTERISTICS (T_J = 125°C NORMAL AIR DRY)

	Item	TO-220	TO-220F	Unit
Without Outer Fin	Thermal Resistance (θ_{ja})	70	60	°C/W
	Power Dissipation (P_D)	1.4	1.7	W
With Outer Fin	Thermal Resistance (θ_{ja})	25	25	°C/W
	Power Dissipation (P_D)	4.0	4.0	W

1. DEVICE USED: 78 SERIES.
2. TYPICAL VALUE.
3. THERMAL RESISTIVITY OF THE RADIATION FIN IS $\theta_{HS} = 20^\circ\text{C/W}$.
4. TIGHTENING TORQUE OF THE RADIATION FIN IS 4 KG·CM, NO SILICON GREASE.

BIPOLAR AND CMOS PRODUCTS

Example: $\frac{\text{NJM } 4558 \text{ D - A (00) (T1)}}{1 \quad 2 \quad 3 \quad 4 \quad 4a \quad 5}$

- Item 1 Item Classification NJM Bipolar
NJU CMOS
- Item 2 Part Number
- Item 3 Package Type

D	DIP	E	EMP
F	QFP	G	SOP
L	SDIP	M	DMP
N	SDIP	V	SSOP
R	VSP	C	Chip
H	TCP		
- Item 4 Selection or Screening Option
- Item 4a ROM Code, Title and Screening Option
- Item 5 Tape & Reel Form T1 or T2 Adhesive
TE1 to 4 Embossed

78 / 79 SERIES REGULATORS

Example: $\frac{\text{NJM } 78\text{M } 00 \text{ FA - B (T1)}}{1 \quad 2 \quad 3 \quad 4 \quad 5 \quad 6}$

- Item 1 Item Classification NJM Bipolar
- Item 2 Part Number
- Item 3 Output Voltage
- Item 4 Package Type

F	TO-220F	U	SOP
DL	TO-252	No	TO-92

(Note) A capital letter after the package shows the output voltage accuracy.
- Item 4a Selection or Screening Option
Capital letters after a hyphen show products that have selected or screened parameters.
- Item 5 Tape & Reel Form T1 or T2 Adhesive
TE1 to 4 Embossed

CMOS REGULATORS

Example: $\frac{\text{NJU } 7201 \text{ L } 00 \text{ (T1)}}{1 \quad 2 \quad 3 \quad 4 \quad 5}$

- Item 1 Item Classification NJU C-MOS
- Item 2 Part Number
- Item 3 Package Type

L	TO-92	U	SOT-89
F	MTP-5		
- Item 4 Output Voltage
- Item 5 Tape & Reel Form T1 or T2 Adhesive
TE1 to 4 Embossed

IR DEVICES

Example: $\frac{\text{NJL } 51 \text{ H } 328}{1 \quad 2 \quad 3 \quad 4}$

- Item 1 **Classification of Items** NJL Opto electronics devices
- Item 2 **Part Number**
- Item 3 **Classification of Package** H Top view V Side view
- Item 4 **Classification of center carrier frequency**
 Example: 32.75kHz 328
 36.00kHz 360

RF MODULES

Example: $\frac{\text{NJH } 30 \ 3 \ 1 \ \text{U} \ -001}{1 \ 2 \ 3 \ 4 \ 5 \ 6}$

- Item 1 **Prefix 1** NJH RF Modules
- Item 2 **Fixed Number** 30
- Item 3 **Functions**
 - 2: TV Tuner
 - 3: RF Modulator
 - 4: RF Modulator with Antenna Switch
 - 5: DBS
 - 9: 3-in-1 Module
- Item 4 **Applications**
 - 1: VHF Output
 - 2: UHF Output
- Item 5 **Destination**
 - U: USA
 - J: Japan
 - D: Southeast Asia
 - E: Europe
 - G: Germany
- Item 6 **Customer Code**
 Three digit numeric suffix code assigned to each customer at time of order

MOTOROLA

Motorola Part Number	NJR Part Number	Comments	Motorola Part Number	NJR Part Number	Comments
DAC08CD	NJMDAC-08MC	Note 1	LM393D	NJM2903M	Note 1
DAC08CP	NJMDAC-08DE		LM393D	NJM2903MG	Note 1
LF353D	NJM353M	Note 1	LM393D	NJM2903MG	Selected-Note 1
LF353N	NJM353D		MC145403	NJU6401B	Note 4
LM2900N	NJM2900N		MC145406	NJU6402B	Note 4
LM2901D	NJM2901E		MC1455D	NJM555E	
LM2901D	NJM2901M	Note 1	MC1455D	NJM555M	Note 1
LM2901D	NJM339E		MC1455P1	NJM555D	
LM2901N	NJM2901N		MC14573	NJU7021	Note 4 Iset=20uA
LM2901N	NJM339D		MC14573	NJU7022	Note 4 Iset=20uA
LM2902D	NJM324E		MC14573	NJU7024	Note 4 Iset=20uA
LM2902D	NJM324M	Note 1	MC14573	NJU7031	Note 4 Iset=200uA
LM2902N	NJM324D		MC14573	NJU7032	Note 4 Iset=200uA
LM2903D	NJM2903E		MC14573	NJU7034	Note 4 Iset=200uA
LM2903D	NJM2903M	Note 1	MC1458D	NJM1458M	Note 1
LM2903N	NJM2903D		MC1458P1	NJM1458D	
LM2904D	NJM2904E		MC14803A	NJU7201L30	
LM2904D	NJM2904M	Note 1	MC14805.2A	NJU7201L52	
LM2904D	NJM358E		MC14805A	NJU7201L50	
LM2904N	NJM2904D		MC1496D	NJM1496M	Note 1
LM2904N	NJM358D		MC1496P	NJM1496D	
LM311D	NJM311E		MC1723CD	NJM723M	Note 1
LM311D	NJM311M	Note 1	MC1723CP	NJM723D	
LM311N	NJM311D		MC1741CD	NJM741E	
LM317T	NJM317F	Note 2	MC1741CD	NJM741M	Note 1
LM324 SSOP	NJM2902V	Note 3	MC1741CP1	NJM741D	
LM324AN	NJM324DA		MC1776CD	NJM4250E	
LM324D	NJM2902E		MC1776CD	NJM4250M	Note 1
LM324D	NJM2902M	Note 1	MC1776CP1	NJM4250D	
LM324D	NJM324E		MC33063AD	NJM2360AM	Note 1
LM324D	NJM324M	Note 1	MC33063AP1	NJM2360AD	
LM324N	NJM324D		MC33063D	NJM2360M	Note 1
LM324P	NJM2902N		MC33063P1	NJM2360D	
LM339 SSOP	NJM2901V	Note 3	MC33167	NJM2367	
LM339D	NJM2901E		MC33172D	NJM022BE	
LM339D	NJM2901M	Note 1	MC33172D	NJM022BM	Note 1
LM339D	NJM339E		MC33172D	NJM2132M	Note 1
LM339N	NJM339D		MC33172P	NJM022BD	
LM339P	NJM2901N		MC33172P	NJM2132D	
LM340T-12	NJM7812FA	Note 2	MC3357D	NJM3357M	Note 1
LM340T-15	NJM7815FA	Note 2	MC3357P	NJM3357D	
LM340T-18	NJM7818FA	Note 2	MC3359P	NJM3359D	
LM340T-24	NJM7824FA	Note 2	MC3362	NJM2292	Note 4
LM340T-5.0	NJM7805FA	Note 2	MC3371	NJM2292	Note 4
LM340T-6.0	NJM7806FA	Note 2	MC3372	NJM2292	
LM340T-8.0	NJM7808FA	Note 2	MC3403D	NJM3403AM	Note 1
LM358D	NJM358E		MC3403P	NJM3403AD	
LM358N	NJM358D		MC34063D	NJM2360M	Note 1
LM3900N	NJM3900N		MC34063P1	NJM2360D	
LM393D	NJM2903E				

CROSS REFERENCE GUIDE

MOTOROLA (CONT.)

Motorola Part Number	NJR Part Number	Comments	Motorola Part Number	NJR Part Number	Comments
LM393LP	NJM2903L		MC34119	NJM2135	
LM393N	NJM2903DQ		MC34119D	NJM2113E	
LM393P	NJM2903D		MC34119D	NJM2113M	Note 1
LM393P	NJM2903DQ	Selected	MC34119P	NJM2113D	
LM833D	NJM2068E		MC34167	NJM2367	
LM833N	NJM2068D		MC34182D	NJM2162M	Note 1
MC1372	NJM1372A		MC34182P	NJM2162D	
MC14051BD	NJU4051BM	Note 1	MC34184D	NJM2164M	Note 1
MC14051BP	NJU4051BD		MC34184P	NJM2164D	
MC14052BD	NJU4052BM	Note 1	MC3456D	NJM556M	Note 1
MC14052BP	NJU4052BD		MC3456P	NJM556D	
MC14053BD	NJU4053BM	Note 1	MC4558D	NJM4558E	
MC14053BP	NJU4053BD		MC4558D	NJM4558M	Note 1
MC14066BD	NJU4066BM	Note 1	MC4558P1	NJM4558D	
MC14066BP	NJU4066BD		MC4741D	NJM4741M	Note 1
MC1411D	NJD6511M	Note 1	MC4741P	NJM4741D	
MC7805CT	NJM7805FA	Note 2	MC79L15ACP	NJM79L15A	
DAC08CP	NJM08CP-08DE		MC1412D	NJD6512M	Note 1
MC7806CT	NJM7806FA	Note 2	MC79L18ACP	NJM79L18A	
MC7808CT	NJM7808FA	Note 2	MC79L24ACP	NJM79L24A	
MC7809CT	NJM7809FA	Note 2	MC79M05CDT	NJM79M05DLA	Note 5
MC7812CT	NJM7812FA	Note 2	MC79M05CT	NJM79M05FA	Note 2
MC7815CT	NJM7815FA	Note 2	MC79M08CDT	NJM79M08DLA	Note 5
MC7818CT	NJM7818FA	Note 2	MC79M12CDT	NJM79M12DLA	Note 5
MC7824CT	NJM7824FA	Note 2	MC79M12CT	NJM79M12FA	Note 2
MC78L05ACP	NJM78L05A		MC79M15CT	NJM79M15FA	Note 2
MC78L08ACP	NJM78L08A		NE592D	NJM592M	Note 1
MC78L12ACP	NJM78L12A		NE592N	NJM592D	
MC78L15ACP	NJM78L15A		TL062ACD	NJM062MA	Note 1
MC78L18ACP	NJM78L18A		TL062CD	NJM062E	
MC78L24ACP	NJM78L24A		TL062CD	NJM062M	Note 1
MC78M05CDT	NJM78M05DLA	Note 5	TL062CP	NJM062D	
MC78M05CT	NJM78M05FA	Note 2	TL064CD	NJM064M	Note 1
MC78M06CT	NJM78M06FA	Note 2	TL064CP	NJM064D	
MC78M08CDT	NJM78M08DLA	Note 5	TL072CD	NJM072M	Note 1
MC78M08CT	NJM78M08FA	Note 2	TL072CP	NJM072D	
MC78M12CDT	NJM78M12DLA	Note 5	TL074CD	NJM074M	Note 1
MC78M12CT	NJM78M12FA	Note 2	TL074CP	NJM074D	
MC78M15CT	NJM78M15FA	Note 2	TL082CD	NJM082E	
MC78M18CT	NJM78M18FA	Note 2	TL082CD	NJM082M	Note 1
MC78M20CT	NJM78M20FA	Note 2	TL082CD	NJM2082M	Note 1
MC78M24CT	NJM78M24FA	Note 2	TL082CP	NJM082D	
MC7905CT	NJM7905FA	Note 2	TL082CP	NJM2082D	
MC7906CT	NJM7906FA	Note 2	TL084CD	NJM084M	Note 1
MC7908CT	NJM7908FA	Note 2	TL084CP	NJM084D	
MC7912CT	NJM7912FA	Note 2	TL431AD	NJM431MA	Note 1
MC7915CT	NJM7915FA	Note 2	TL431CD	NJM431E	
MC7918CT	NJM7918FA	Note 2	TL431D	NJM431M	Note 1
MC7924CT	NJM7924FA	Note 2	TL431LP	NJM431L	
MC79L05ACP	NJM79L05A		TL431P	NJM431D	
MC79L12ACP	NJM79L12A				

NATIONAL

NSC Part Number	NJR Part Number	Comments	NSC Part Number	NJR Part Number	Comments
CD4051BC	NJU4051BD		LM324 SSOP	NJM2902V	Note 3
CD4051BM	NJU4051BM	Note 1	LM324AN	NJM324DA	
CD4052BC	NJU4052BD		LM324D	NJM2902E	
CD4052BM	NJU4052BM	Note 1	LM324D	NJM2902M	Note 1
CD4053BC	NJU4053BD		LM324M	NJM324E	
CD4053BM	NJU4053BM	Note 1	LM324M	NJM324M	Note 1
CD4066BC	NJU4066BD		LM324N	NJM2902N	
CD4066BM	NJU4066BM	Note 1	LM324N	NJM324D	
DAC-0801LCM	NJMDAC-08MC	Note 1	LM336	NJM431	
DAC-0801LCN	NJMDAC-08DE		LM339 SSOP	NJM2901V	Note 3
DS14C232	NJU6401B	Note 4	LM339D	NJM2901E	
DS14C232	NJU6402B	Note 4	LM339D	NJM2901M	Note 1
LF11201D	NJU201AD		LM339M	NJM339E	
LF347M	NJM074M	Note 1	LM339N	NJM2901N	
LF347N	NJM074D		LM339N	NJM339D	
LF353M	NJM353M	Note 1	LM340T-10	NJM7810FA	Note 2
LF353N	NJM353D		LM340T-12	NJM7812FA	Note 2
LM13600M	NJM13600M	Note 1	LM340T-15	NJM7815FA	Note 2
LM13600N	NJM13600D		LM340T-5.0	NJM7805FA	Note 2
LM13700M	NJM13700M	Note 1	LM341T-12	NJM78M12FA	Note 2
LM13700N	NJM13700D		LM341T-15	NJM78M15FA	Note 2
LM1458M	NJM1458M	Note 1	LM341T-5.0	NJM78M05FA	Note 2
LM1458M	NJM4558E		LM348M	NJM4741M	Note 1
LM1458N	NJM1458D		LM348N	NJM4741D	
LM1458N	NJM4558D		LM349M	NJM4741M	Note 1
LM1496M	NJM1496M	Note 1	LM349N	NJM4741D	
LM1496N	NJM1496D		LM358M	NJM358E	
LM185	NJM2373		LM358N	NJM358D	
LM2575	NJM2367		LM360M	NJM360E	
LM2901D	NJM339E		LM360M	NJM360M	Note 1
LM2901M	NJM2901E		LM360N	NJM360D	
LM2901M	NJM2901M	Note 1	LM386M-1 (-3)	NJM386E	
LM2901N	NJM2901N		LM386M-1 (-3)	NJM386M	Note 1
LM2901N	NJM339D		LM386M-1 (-3)	NJM386M	Note 1
LM2902D	NJM324E		LM386M-4	NJM386BE	
LM2902D	NJM324M	Note 1	LM386M-4	NJM386BM	Note 1
LM2902M	NJM2902E		LM386N-1 (-3)	NJM386D	
LM2902M	NJM2902M	Note 1	LM386N-1 (-3)	NJM387D	Note 1
LM2902N	NJM2902N		LM386N-4	NJM386BD	
LM2902N	NJM324D		LM393ACZ	NJM2903L	
LM2903M	NJM2903E		LM393D	NJM2903E	
LM2903M	NJM2903M	Note 1	LM393D	NJM2903M	Note 1
LM2903N	NJM2903D		LM393D	NJM2903MG	Selected-Note 1
LM2904D	NJM358E		LM393M	NJM2903MG	Note 1
LM2904M	NJM2904E		LM393N	NJM2903D	
LM2904M	NJM2904M	Note 1	LM393N	NJM2903DQ	
LM2904N	NJM2904D		LM393N	NJM2903DQ	Selected
LM2904N	NJM358D		LM4250CM	NJM4250E	
LM2930T-5.0	NJM2930F05	Note2	LM4250CM	NJM4250M	Note 1
LM2930T-8.0	NJM2930F08	Note2	LM4250CN	NJM4250D	
LM2931Z-5.0	NJM2930L05		LM431ACM	NJM431E	
LM311D	NJM311D		LM431ACM	NJM431M	Note 1
LM311M	NJM311E		LM431ACZ	NJM431L	
LM311M	NJM311M	Note 1	LM555CM	NJM555E	
LM317T	NJM317F	Note2			

NATIONAL (CONT.)

NSC Part Number	NJR Part Number	Comments	NSC Part Number	NJR Part Number	Comments
LM318M	NJM318E		LM555CM	NJM555M	Note 1
LM318M	NJM318M	Note 1	LM555CN	NJM555D	
LM318N	NJM318D		LM556CM	NJM556M	Note 1
LM319M	NJM319E		LM556CN	NJM556D	
LM319M	NJM319M	Note 1	LM567CM	NJM567M	Note 1
LM319N	NJM319D		LM567CN	NJM567D	
LM320LZ-12	NJM79L12A		LM592M	NJM592M	Note 1
LM320LZ-15	NJM79L15A		LM592N	NJM592D	
LM320LZ-5.0	NJM79L05A		LM723CM	NJM723M	Note 1
LM320T-12	NJM7912FA	Note 2	LM723CN	NJM723D	
LM320T-15	NJM7915FA	Note 2	LM741CM	NJM741E	
LM320T-5.0	NJM7905FA	Note 2	LM741CN	NJM741M	Note 1
LM741CN	NJM741D		LMC6041AM	NJU7051M	Note 1 Top =-40-85C
LM7805CT	NJM7805FA	Note 2	LMC6041AN	NJU7051D	Top= -40-85C NSC
LM7806CT	NJM7806FA	Note 2	LMC6041M	NJU7051M	Note 1 Top =-40-85C
LM7808CT	NJM7808FA	Note 2	LMC6041N	NJU7051D	Top= -40-85C NSC
LM7812CT	NJM7812FA	Note 2	LMC6042AM	NJU7052M	Note 1 Top =-40-85C
LM7815CT	NJM7815FA	Note 2	LMC6042AN	NJU7052D	Top= -40-85C NSC
LM7818CT	NJM7818FA	Note 2	LMC6042M	NJU7052M	Note 1 Top =-40-85C
LM7824CT	NJM7824FA	Note 2	LMC6042N	NJU7052D	Top= -40-85C NSC
LM78L05ACZ	NJM78L05A		LMC6044AM	NJU7054M	Note 1 Top =-40-85C
LM78L06ACZ	NJM78L06A	Vo=6.2V on NSC	LMC6044AN	NJU7054D	Top= -40-85C NSC
LM78L08ACZ	NJM78L08A	Vo=8.2V on NSC	LMC6044M	NJU7054M	Note 1 Top =-40-85C
LM78L09ACZ	NJM78L09A		LMC6044N	NJU7054D	Top= -40-85C NSC
LM78L12ACZ	NJM78L12A		LMC660AIM	NJU7064M	Note 1
LM78L15ACZ	NJM78L15A		LMC660AIM	NJU7074M	Note 1
LM78M05CT	NJM78M05FA	Note 2	LMC660AIN	NJU7064D	
LM78M06CT	NJM78M06FA	Note 2	LMC660AIN	NJU7074D	
LM78M08CT	NJM78M08FA	Note 2	LMC660CM	NJU7024M	Note 1
LM78M12CT	NJM78M12FA	Note 2	LMC660CM	NJU7034M	Note 1
LM78M15CT	NJM78M15FA	Note 2	LMC660CN	NJU7024D	
LM78M24CT	NJM78M24FA	Note 2	LMC660CN	NJU7034D	
LM7905CT	NJM7905FA	Note 2	LMC662AIM	NJU7062M	Note 1
LM7908CT	NJM7908FA	Note 2	LMC662AIM	NJU7072M	Note 1
LM7912CT	NJM7912FA	Note 2	LMC662AIN	NJU7062D	
LM7915CT	NJM7915FA	Note 2	LMC662AIN	NJU7072D	
LM79L05ACZ	NJM79L05A		LMC662CM	NJU7022M	Note 1
LM79L12ACZ	NJM79L12A		LMC662CM	NJU7032M	Note 1
LM79L15ACZ	NJM79L15A		LMC662CN	NJU7022D	
LM79M05CT	NJM79M05FA	Note 2	LMC662CN	NJU7032D	
LM79M08CT	NJM79M08FA	Note 2	LP2980	NJM2370	
LM79M12CT	NJM79M12FA	Note 2	LPC6611M	NJU7071M	Note 1, Icc(max)=0.1mA
LM79M15CT	NJM79M15FA	Note 2	LPC6611N	NJU7071D	Icc(max)=0.1mA NSC
LM833M	NJM2068E		NS733	NJM592D	
LM833M	NJM2068M	Note 1	OP07CP	NJMOP-07D	
LM833N	NJM2068D		OP07DP	NJMOP-07D	
LMC6022M	NJU7022M	Note 1	TL072CM	NJM072M	Note 1
LMC6022N	NJU7022D		TL072CP	NJM072D	
LMC6024M	NJU7024M	Note 1	TL082CM	NJM082E	
LMC6024N	NJU7024D		TL082CM	NJM082M	Note 1
LMC6032M	NJU7032M	Note 1	TL082CM	NJM2082M	Note 1
LMC6032N	NJU7032D		TL082CP	NJM082D	
LMC6034M	NJU7034M	Note 1	TL082CP	NJM2082D	
LMC6034N	NJU7034D				

TEXAS INSTRUMENTS

TI Part Number	NJR Part Number	Comments	TI Part Number	NJR Part Number	Comments
LM13600N	NJM13600D		SG3524N	NJM3524D	
LM13600NS	NJM13600M		SG3524NS	NJM3524M	Note 1
LM13700N	NJM13700D		SN75C1406	NJU6401B	Note 4
LM13700NS	NJM13700NS		SN75C1454	NJU6402B	Note 4
LM2901D	NJM2901E		TL022CD	NJM022BE	
LM2901D	NJM2901M	Note 1	TL022CD	NJM022BM	Note 1
LM2901DBLE	NJM2901V	Note 3	TL022CD	NJM022E	
LM2901N	NJM2901N		TL022CP	NJM022BD	
LM2902D	NJM2902E		TL022CP	NJM022D	
LM2902DBLE	NJM2902V	Note 3	TL022CPS	NJM022M	Note 1
LM2902N	NJM2902N		TL062ACD	NJM062MA	Note 1
LM2902NS	NJM2902M	Note 1	TL062BCD	NJM062MB	Note 1
LM2903D	NJM2903E		TL062CD	NJM062E	
LM2903D	NJM2903M	Note 1	TL062CP	NJM062D	
LM2903DB	NJM3902V	Note 3	TL062CPS	NJM062M	Note 1
LM2903P	NJM2903D		TL064CN	NJM064D	
LM2904D	NJM2904E		TL064CNS	NJM064M	Note 1
LM2904DB	NJM2904V	Note 3	TL072BCP	NJM072BMB	Note 1
LM2904P	NJM2904D		TL072CP	NJM072D	
LM2904PS	NJM2904M	Note 1	TL072CPS	NJM072M	Note 1
LM2930KC-5.0	NJM2930F05	Note 2	TL074CN	NJM074D	
LM2930KC-8.0	NJM2930F08	Note 2	TL074CNS	NJM074M	Note 1
LM2930LP-5.0	NJM2930L05		TL082CD	NJM082E	
LM2930LP-8.0	NJM2930L08		TL082CD	NJM2082M	Note 1
LM311D	NJM311E		TL082CP	NJM082D	
LM311P	NJM311D		TL082CP	NJM2082D	
LM311PS	NJM311M	Note 1	TL082CPS	NJM082M	Note 1
LM317AB	NJM317F		TL084CN	NJM084D	
LM318D	NJM318E		TL084CNS	NJM084M	Note 1
LM318P	NJM318D		TL431ACD	NJM431MA	Note 1
LM318PS	NJM318M	Note 1	TL431ACPK	NJM431UA	
LM324AN	NJM324DA		TL431CD	NJM431E	
LM324D	NJM324E		TL431CLP	NJM431L	
LM324N	NJM324D		TL431CP	NJM431D	
LM324NS	NJM324M	Note 1	TL431CPK	NJM431U	
LM339D	NJM339E		TL431PS	NJM431M	Note 1
LM339N	NJM339D		TLC2272CD	NJU7072M	Note 1
LM358D	NJM358E		TLC2272CP	NJU7072D	
LM358P	NJM358D		TLC2272CP	NJU7074D	
LM393D	NJM2903MG	Note 1	TLC2274CD	NJU7074M	Note 1
LM393P	NJM2903DQ		TLC271BCD	NJU7051M	Note 1
MC1458P	NJM1458D		TLC271BCD	NJU7061M	Note 1
MC1458PS	NJM1458M	Note 1	TLC271BCD	NJU7071M	Note 1
MC3403N	NJM3403AD		TLC271BCP	NJU7051D	
MC3403NS	NJM3403AM	Note 1	TLC271BCP	NJU7061D	
MC79L05CLP	NJM79L05A		TLC271BCP	NJU7071D	
MC79L12CLP	NJM79L12A		TLC271CD	NJU7001M	Note 1
MC79L15CLP	NJM79L15A		TLC271CD	NJU7021M	Note 1
NE5532P	NJM5532D		TLC271CD	NJU7031M	Note 1
NE5532PS	NJM5532M	Note 1	TLC271CP	NJU7001D	
NE5534P	NJM5534D		TLC271CP	NJU7021D	
NE5534PS	NJM5534M	Note 1	TLC271CP	NJU7031D	
NE555D	NJM555E		TLC272BCD	NJU7072M	Note 1

TEXAS INSTRUMENTS

TI Part Number	NJR Part Number	Comments	TI Part Number	NJR Part Number	Comments
NE555D	NJM555M	Note 1	TLC272BCP	NJU7072D	
NE555P	NJM555D		TLC272CD	NJU7032M	Note 1
NE556D	NJM556M	Note 1	TLC272CP	NJU7032D	
NE556P	NJM556D		TLC274BCD	NJU7074M	Note 1
NE592D	NJM592M	Note 1	TLC274BCP	NJU7074D	
NE592N	NJM592D		TLC274CD	NJU7034M	Note 1
OP07CP	NJMOP-07D		TLC274CP	NJU7034D	
OP07CPS	NJMOP-07M	Note 1	TLC27L2BCD	NJU7052M	Note 1
OP07DD	NJMOP-07M	Note 1	TLC27L2BCP	NJU7052D	
OP07DP	NJMOP-07D		TLC27L2CD	NJU7002M	Note 1
RC4558D	NJM4558E		TLC27L2CP	NJU7002D	
RC4558DBLE	NJM4558V	Note 3	TLC27L4BCD	NJU7054M	Note 1
RC4558P	NJM4558D		TLC27L4BCP	NJU7054D	
RC4558PS	NJM4558M	Note 1	TLC27L4CD	NJU7004M	Note 1
TLC27L4CP	NJU7004D		UA78L09CLP	NJM78L09A	
TLC27M2BCD	NJU7062M	Note 1	UA78L10CLP	NJM78L10UA	
TLC27M2BCP	NJU7062D		UA78L12CLP	NJM78L12A	
TLC27M2CD	NJU7022M	Note 1	UA78L15CLP	NJM78L15A	
TLC27M2CP	NJU7022D		UA78M05CKC	NJM78M05FA	Note 2
TLC27M4BCD	NJU7064M	Note 1	UA78M06CKC	NJM78M06FA	Note 2
TLC27M4BCP	NJU7064D		UA78M08CKC	NJM78M08FA	Note 2
TLC27M4CD	NJU7024M	Note 1	UA78M09CKC	NJM78M09FA	Note 2
TLC27M4CP	NJU7024D		UA78M10CKC	NJM78M10FA	Note 2
TLC339CD	NJU7114AM	Note 1	UA78M12CKC	NJM78M12FA	Note 2
TLC339CP	NJU7114AD		UA78M15CKC	NJM78M15FA	Note 2
TLC3702CD	NJU7102AM	Note 1	UA78M20CKC	NJM78M20FA	Note 2
TLC3702CP	NJU7102AD		UA78M24CKC	NJM78M24FA	Note 2
TLC3704CD	NJU7104AM	Note 1	UA7905CKC	NJM7905FA	Note 2
TLC3704CP	NJU7104AD		UA7906CKC	NJM7906FA	Note 2
TLC393CD	NJU7112AM	Note 1	UA7908CKC	NJM7908FA	Note 2
TLC393CP	NJU7112AD		UA7912CKC	NJM7912FA	Note 2
UA723CD	NJM723M	Note 1	UA7915CKC	NJM7915FA	Note 2
UA723CN	NJM723D		UA7918CKC	NJM7918FA	Note 2
UA741CD	NJM741E		UA7924CKC	NJM7924FA	Note 2
UA741CP	NJM741D		UA79M05CKC	NJM79M05FA	Note 2
UA741CPS	NJM741M	Note 1	UA79M06CKC	NJM79M06FA	Note 2
UA7805CKC	NJM7805FA	Note 2	UA79M08CKC	NJM79M08FA	Note 2
UA7806CKC	NJM7806FA	Note 2	UA79M12CKC	NJM79M12FA	Note 2
UA7808CKC	NJM7808FA	Note 2	UA79M15CKC	NJM79M15FA	Note 2
UA7810CKC	NJM7810FA	Note 2	UA79M24CKC	NJM79M24FA	Note 2
UA7812CKC	NJM7812FA	Note 2			
UA7815CKC	NJM7815FA	Note 2			
UA7818CKC	NJM7818FA	Note 2			
UA7824CKC	NJM7824FA	Note 2			
UA78L02CKC	NJM78L02A				
UA78L05CLP	NJM78L05UA				
UA78L06CLP	NJM78L06A	Vo=6.2V TI			
UA78L08CLP	NJM78L08A				

SGS-THOMSON

SGS Part Number	NJR Part Number	Comments	SGS Part Number	NJR Part Number	Comments
L7805CV	NJM7805FA	Note 2	TS271CD (low)	NJU7001M	Note 1
L7806CV	NJM7806FA	Note 2	TS271CD (med)	NJU7021M	Note 1
L7808CV	NJM7808FA	Note 2	TS271CN (high)	NJU7031D	
L7809CV	NJM7809FA	Note 2	TS271CN (low)	NJU7001D	
L7812CV	NJM7812FA	Note 2	TS271CN (med)	NJU7021D	
L7815CV	NJM7815FA	Note 2	TS272BCD	NJU7072M	Note 1
L7818CV	NJM7818FA	Note 2	TS272BCN	NJU7072D	
L7820CV	NJM7820FA	Note 2	TS272CD	NJU7032M	Note 1
L7824CV	NJM7824FA	Note 2	TS272CN	NJU7032D	
L78M05CV	NJM78M05FA	Note 2	TS274BCD	NJU7074M	Note 1
L78M06CV	NJM78M05FA	Note 2	TS274BCN	NJU7074D	
L78M06CV	NJM78M06FA	Note 2	TS274CD	NJU7034M	Note 1
L78M08CV	NJM78M08FA	Note 2	TS274CN	NJU7034D	
L78M10CV	NJM78M10FA	Note 2	TS27L2BCD	NJU7052M	Note 1
L78M12CV	NJM78M12FA	Note 2	TS27L2BCN	NJU7052D	
L78M15CV	NJM78M15FA	Note 2	TS27L2CD	NJU7002M	Note 1
L78M18CV	NJM78M18FA	Note 2	TS27L2CN	NJU7002D	
L78M20CV	NJM78M20FA	Note 2	TS27L4BCD	NJU7054M	Note 1
L78M24CV	NJM78M24FA	Note 2	TS27L4BCN	NJU7054D	
L7905CV	NJM7905FA	Note 2	TS27L4CD	NJU7004M	Note 1
L7906CV	NJM7906FA	Note 2	TS27L4CN	NJU7004D	
L7908CV	NJM7908FA	Note 2	TS27M2BCD	NJU7062M	Note 1
L7912CV	NJM7912FA	Note 2	TS27M2BCN	NJU7062D	
L7915CV	NJM7915FA	Note 2	TS27M2CD	NJU7022M	Note 1
L7918CV	NJM7918FA	Note 2	TS27M2CN	NJU7022D	
L7924CV	NJM7924FA	Note 2	TS27M4BCD	NJU7064M	Note 1
LM317T	NJM317F	Note 2	TS27M4BCN	NJU7064D	
LM324AN	NJM324DA		TS27M4CD	NJU7024M	Note 1
LM723 SMT	NJM723M	Note 1	TS27M4CN	NJU7024D	
LM723N	NJM723D		TS339CD	NJU7114AM	Note 1
NE555 SMT	NJM555E		TS339CN	NJU7114AD	
NE555 SMT	NJM555M	Note 1	TS3702CD	NJU7102AM	Note 1
NE555N	NJM555D		TS3702CN	NJU7102AD	
NE556 SMT	NJM556M	Note 1	TS3704CD	NJU7104AM	Note 1
NE556N	NJM556D		TS3704CN	NJU7104AD	
SG3524N	NJM3524M	Note 1	TS393CD	NJU7112AM	Note 1
SG3524P	NJM3524D		TS393CN	NJU7112AD	
TDA2822M	NJM2073D				
TDA7335P	NJM2085M	Note 1			
TS271BCD (high)	NJU7071M	Note 1			
TS271BCD (low)	NJU7051M	Note 1			
TS271BCD (med)	NJU7061M	Note 1			
TS271BCN (high)	NJU7071D				
TS271BCN (low)	NJU7051D				
TS271BCN (med)	NJU7061D				
TS271CD (high)	NJU7031M	Note 1			

Note 1: EIAJ (Electronics Industrial Association of Japan) standard package. The width of the package is slightly wider than the JEDEC std. (US). However, since EIAJ parts have the same lead pitch as JEDEC parts, they can usually be placed on the JEDEC footprint without problems.

Note 2: TO-220F (Full Molded TO-220 package) The mechanical dimensions are different due to the encapsulated fin. Please refer to the attached illustration.

Note 3: SSOP Package (Shrink SOP Package) is available.

Note 4: Devices are functionally equivalent, but NOT pin-to-pin compatible.

Note 5: TO-252 or DPACK Package: designated with suffix "DLA"

NOTES



NOTES

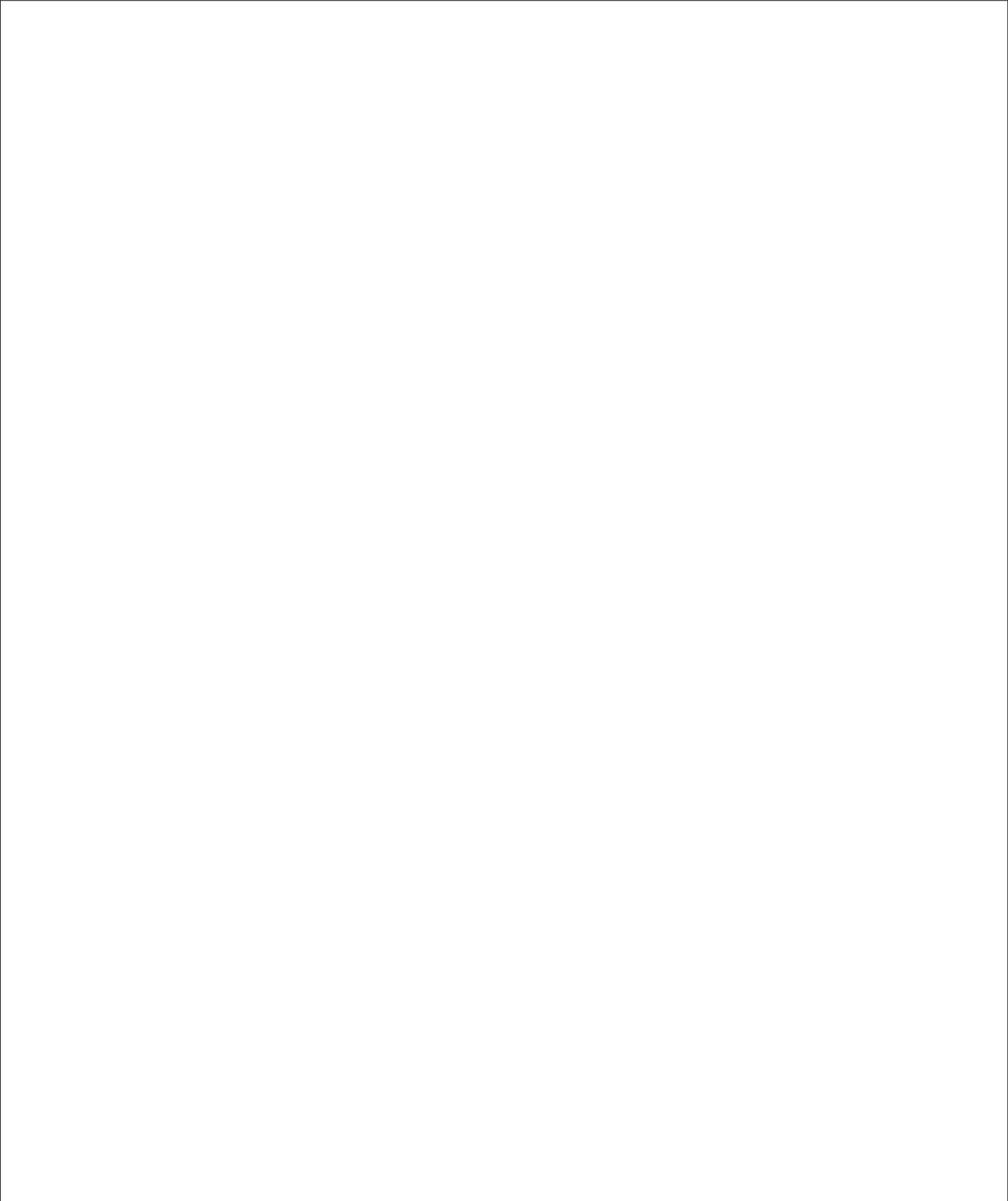

NOTES

