

Features

- 1500W Peak Pulse Power Dissipation
- 5.0V - 170V Standoff Voltages
- Glass Passivated Die Construction
- Unidirectional and Bidirectional Versions Available
- Excellent Clamping Capability
- Fast Response Time
- **Lead-Free Finish; RoHS Compliant (Notes 1 & 2)**
- **Halogen and Antimony Free. "Green" Device (Notes 3 & 4)**

Mechanical Data

- Case: SMC
- Case Material: Molded Plastic. UL Flammability Classification Rating 94V-0
- Terminals: Lead-Free Plating (Matte Tin Finish). Solderable per MIL-STD-202, Method 208②③
- Polarity Indicator: Cathode Band (Note: Bidirectional devices have no polarity indicator.)
- Weight: 0.21 grams (Approximate)

SMC

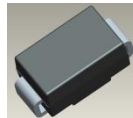

Top View

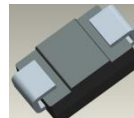

Bottom View

Ordering Information (Note 5)

Part Number	Case	Packaging
SMCJXXX(C)A-13-F	SMC	3000/Tape & Reel

*x = Device Voltage, e.g., SMCJ170A-13-F.

- Notes:
1. EU Directive 2002/95/EC (RoHS) & 2011/65/EU (RoHS 2) compliant. All applicable RoHS exemptions applied.
 2. See http://www.diodes.com/quality/lead_free.html for more information about Diodes Incorporated's definitions of Halogen- and Antimony-free, "Green" and Lead-free.
 3. Halogen- and Antimony-free "Green" products are defined as those which contain <900ppm bromine, <900ppm chlorine (<1500ppm total Br + Cl) and <1000ppm antimony compounds.
 4. Product manufactured with Date Code 0924 (week 24, 2009) and newer are built with Green Molding Compound.
 5. For packaging details, go to our website at <http://www.diodes.com/products/packages.html>.

Marking Information

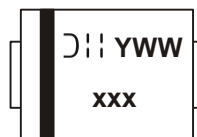

xxx = Product Type Marking Code (See Page 2)
 011 = Manufacturers' Code Marking
 YWW = Date Code Marking
 Y = Last Digit of Year (ex: 4 for 2014)
 WW = Week Code (01 to 53)

Maximum Ratings (@T_A = +25°C unless otherwise specified.)

Characteristic	Symbol	Value	Unit
Peak Pulse Power Dissipation (Non repetitive current pulse derated above T _A = +25°C) (Note 6)	P _{PK}	1500	W
Peak Forward Surge Current, 8.3ms Single Half Sine-Wave Superimposed on Rated Load (Notes 6, 7, & 8)	I _{FSM}	200	A
Steady State Power Dissipation @ T _L = +75°C	PM _(AV)	5.0	W
Instantaneous Forward Voltage @ I _{FP} = 100A (Notes 6 & 8)	V _F	See Note 9	V

Thermal Characteristics

Characteristic	Symbol	Value	Unit
Operating Temperature Range	T _J	-55 to +150	°C
Storage Temperature Range	T _{STG}	-55 to +175	°C

- Notes:
6. Valid provided that terminals are kept at ambient temperature.
 7. Measured with 8.3ms single half sine-wave. Duty cycle = 4 pulses per minute maximum.
 8. Unidirectional units only.
 9. V_F = 3.5V for SMCJ5.0A through SMCJ90A, and V_F = 5.0V for SMCJ100A through SMCJ170A.

Electrical Characteristics (@T_A = +25°C unless otherwise specified.)

Part Number Add C For Bidirectional (Note 10)	Reverse Standoff Voltage	Breakdown Voltage V _{BR} @ I _T (Note 11)		Test Current	Max. Reverse Leakage @ V _{RWM} (Note 12)	Max. Clamping Voltage @ I _{pp}	Max. Peak Pulse Current I _{pp}	Marking Code	
	V _{RWM} (V)	Min (V)	Max (V)	I _T (mA)	I _R (μA)	V _C (V)	(A)	BI	UNI
SMCJ5.0(C)A	5.0	6.40	7.07	10	1000	9.2	163.0	BDE	GDE
SMCJ6.0(C)A	6.0	6.67	7.37	10	1000	10.3	145.6	BDG	GDG
SMCJ6.5(C)A	6.5	7.22	7.98	10	500	11.2	133.9	BDK	GDK
SMCJ7.0(C)A	7.0	7.78	8.60	10	200	12.0	125.0	BDM	GDM
SMCJ7.5(C)A	7.5	8.33	9.21	1.0	100	12.9	116.3	BDP	GDP
SMCJ8.0(C)A	8.0	8.89	9.83	1.0	50	13.6	110.3	BDR	GDR
SMCJ8.5(C)A	8.5	9.44	10.4	1.0	20	14.4	104.2	BDT	GDT
SMCJ9.0(C)A	9.0	10.00	11.1	1.0	10	15.4	97.4	BDV	GDV
SMCJ10(C)A	10.0	11.10	12.3	1.0	5.0	17.0	88.2	BDX	GDY
SMCJ11(C)A	11.0	12.20	13.5	1.0	5.0	18.2	82.4	BDZ	GDZ
SMCJ12(C)A	12.0	13.30	14.7	1.0	5.0	19.9	75.3	BEE	GEE
SMCJ13(C)A	13.0	14.40	15.9	1.0	5.0	21.5	69.7	BEG	GEG
SMCJ14(C)A	14.0	15.60	17.2	1.0	5.0	23.2	64.7	BEK	GEK
SMCJ15(C)A	15.0	16.70	18.5	1.0	5.0	24.4	61.5	BEM	GEM
SMCJ16(C)A	16.0	17.80	19.7	1.0	5.0	26.0	57.7	BEP	GEP
SMCJ17(C)A	17.0	18.90	20.9	1.0	5.0	27.6	53.3	BER	GER
SMCJ18(C)A	18.0	20.00	22.1	1.0	5.0	29.2	51.4	BET	GET
SMCJ20(C)A	20.0	22.20	24.5	1.0	5.0	32.4	46.3	BEV	GEV
SMCJ22(C)A	22.0	24.40	27.0	1.0	5.0	35.5	42.2	BEX	GEX
SMCJ24(C)A	24.0	26.70	29.5	1.0	5.0	38.9	38.6	BEZ	GEZ
SMCJ26(C)A	26.0	28.90	31.9	1.0	5.0	42.1	35.6	BFE	GFE
SMCJ28(C)A	28.0	31.10	34.4	1.0	5.0	45.4	33.0	BFG	GFG
SMCJ30(C)A	30.0	33.30	36.8	1.0	5.0	48.4	31.0	BFK	GFK
SMCJ33(C)A	33.0	36.70	40.6	1.0	5.0	53.3	28.1	BFM	GFM
SMCJ36(C)A	36.0	40.00	44.2	1.0	5.0	58.1	25.8	BFP	GFP
SMCJ40(C)A	40.0	44.40	49.1	1.0	5.0	64.5	23.2	BFR	GFR
SMCJ43(C)A	43.0	47.80	52.8	1.0	5.0	69.4	21.6	BFT	GFT
SMCJ45(C)A	45.0	50.00	55.3	1.0	5.0	72.7	20.6	BFV	GFV
SMCJ48(C)A	48.0	53.30	58.9	1.0	5.0	77.4	19.4	BFX	GFY
SMCJ51(C)A	51.0	56.70	62.7	1.0	5.0	82.4	18.2	BFZ	GFZ
SMCJ54(C)A	54.0	60.00	66.3	1.0	5.0	87.1	17.2	BGE	GGE
SMCJ58(C)A	58.0	64.40	71.2	1.0	5.0	93.6	16.0	BGG	GGG
SMCJ60(C)A	60.0	66.70	73.7	1.0	5.0	96.8	15.5	BGK	GGK
SMCJ64(C)A	64.0	71.10	78.6	1.0	5.0	103.0	14.6	BGM	GGM
SMCJ70(C)A	70.0	77.80	86.0	1.0	5.0	113.0	13.3	BGP	GGP
SMCJ75(C)A	75.0	83.30	92.1	1.0	5.0	121.0	12.4	BGR	GGR
SMCJ78(C)A	78.0	86.70	95.8	1.0	5.0	126.0	11.4	BGT	GGT
SMCJ85(C)A	85.0	94.40	104	1.0	5.0	137.0	10.4	BGV	GGV
SMCJ90(C)A	90.0	100.00	111	1.0	5.0	146.0	10.3	BGX	GGX
SMCJ100(C)A	100.0	111.00	123	1.0	5.0	162.0	9.3	BGZ	GGZ
SMCJ110(C)A	110.0	122.00	135	1.0	5.0	177.0	8.4	BHE	GHE
SMCJ120(C)A	120.0	133.00	147	1.0	5.0	193.0	7.9	BHG	GHG
SMCJ130(C)A	130.0	144.00	159	1.0	5.0	209.0	7.2	BHK	GHK
SMCJ150(C)A	150.0	167.00	185	1.0	5.0	243.0	6.2	BHM	GHM
SMCJ160(C)A	160.0	178.00	197	1.0	5.0	259.0	5.8	BHP	GHP
SMCJ170(C)A	170.0	189.00	209	1.0	5.0	275.0	5.5	BHR	GHR

Notes: 10. Suffix C denotes bidirectional device.
11. V_{BR} measured with I_T current pulse = 10 ~ 15 ms.
12. For bidirectional devices having V_{RWM} of 10V and under, the I_R is doubled.

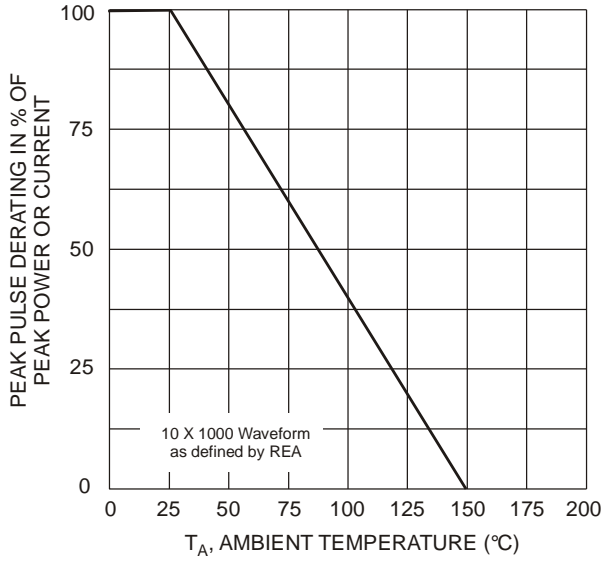

Fig. 1 Pulse Derating Curve

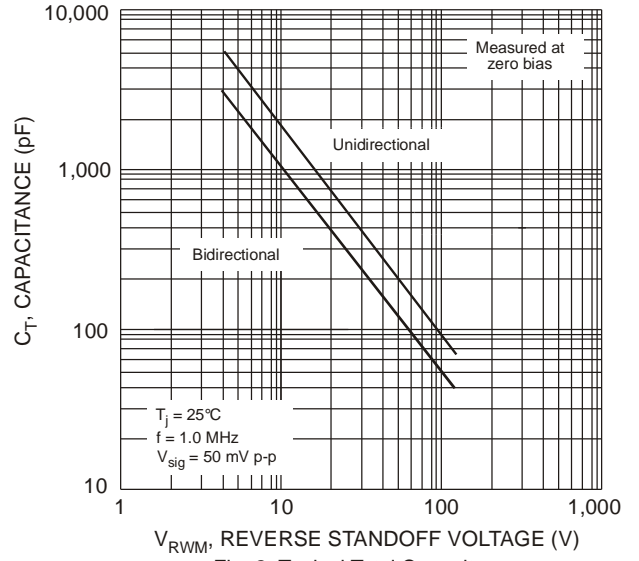

Fig. 2 Typical Total Capacitance

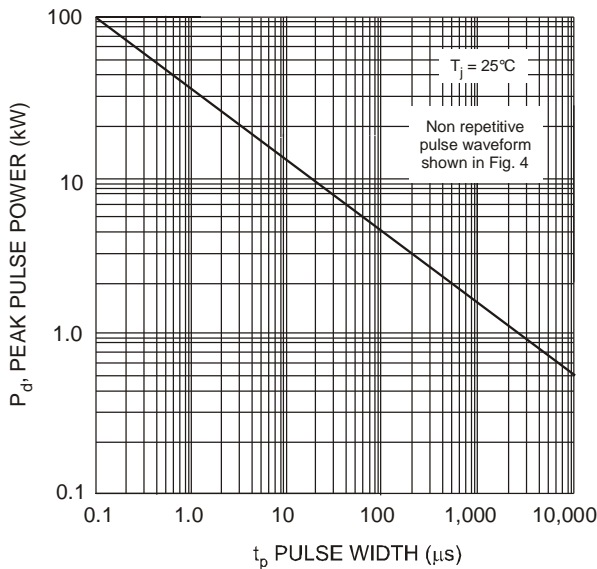

Fig. 3 Pulse Rating Curve

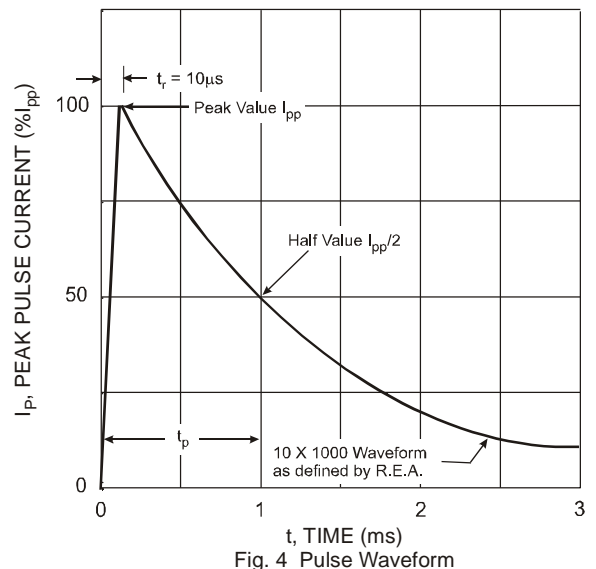

Fig. 4 Pulse Waveform

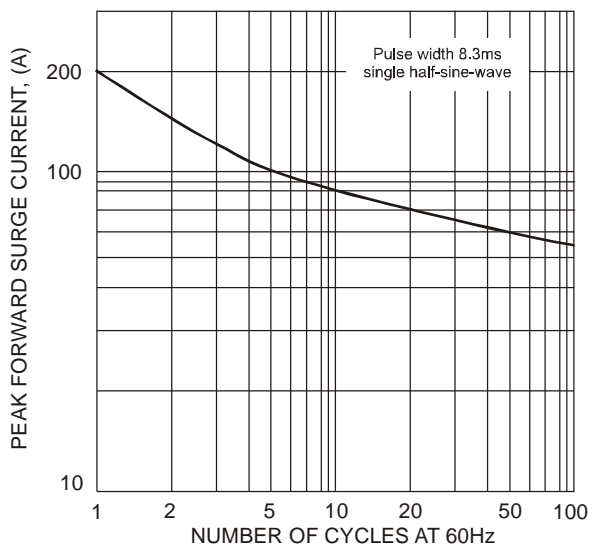

Fig. 5, Maximum Non-Repetitive Surge Current

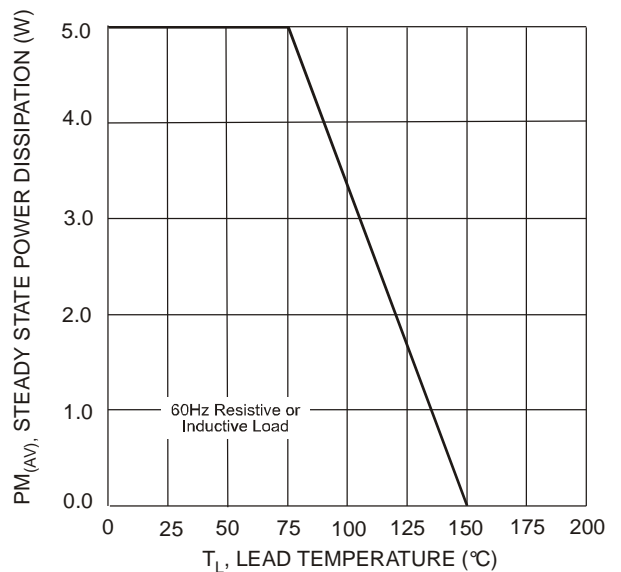
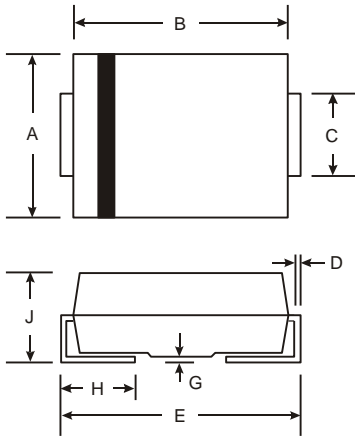

Fig. 6 Steady State Power Derating Curve

Package Outline Dimensions

Please see AP02002 at <http://www.diodes.com/datasheets/ap02002.pdf> for the latest version.



SMC		
Dim	Min	Max
A	5.59	6.22
B	6.60	7.11
C	2.75	3.18
D	0.15	0.31
E	7.75	8.13
G	0.10	0.20
H	0.76	1.52
J	2.00	2.50
All Dimensions in mm		

Suggested Pad Layout

Please see AP02001 at <http://www.diodes.com/datasheets/ap02001.pdf> for the latest version.

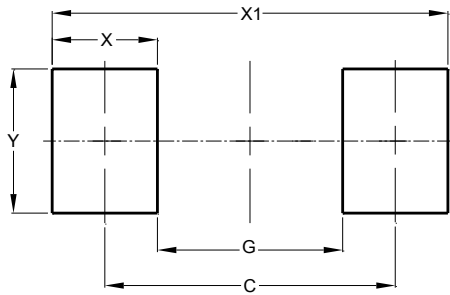

Dimensions	Value (in mm)
C	6.90
G	4.40
X	2.50
X1	9.40
Y	3.30

IMPORTANT NOTICE

DIODES INCORPORATED MAKES NO WARRANTY OF ANY KIND, EXPRESS OR IMPLIED, WITH REGARDS TO THIS DOCUMENT, INCLUDING, BUT NOT LIMITED TO, THE IMPLIED WARRANTIES OF MERCHANTABILITY AND FITNESS FOR A PARTICULAR PURPOSE (AND THEIR EQUIVALENTS UNDER THE LAWS OF ANY JURISDICTION).

Diodes Incorporated and its subsidiaries reserve the right to make modifications, enhancements, improvements, corrections or other changes without further notice to this document and any product described herein. Diodes Incorporated does not assume any liability arising out of the application or use of this document or any product described herein; neither does Diodes Incorporated convey any license under its patent or trademark rights, nor the rights of others. Any Customer or user of this document or products described herein in such applications shall assume all risks of such use and will agree to hold Diodes Incorporated and all the companies whose products are represented on Diodes Incorporated website, harmless against all damages.

Diodes Incorporated does not warrant or accept any liability whatsoever in respect of any products purchased through unauthorized sales channel. Should Customers purchase or use Diodes Incorporated products for any unintended or unauthorized application, Customers shall indemnify and hold Diodes Incorporated and its representatives harmless against all claims, damages, expenses, and attorney fees arising out of, directly or indirectly, any claim of personal injury or death associated with such unintended or unauthorized application.

Products described herein may be covered by one or more United States, international or foreign patents pending. Product names and markings noted herein may also be covered by one or more United States, international or foreign trademarks.

This document is written in English but may be translated into multiple languages for reference. Only the English version of this document is the final and determinative format released by Diodes Incorporated.

LIFE SUPPORT

Diodes Incorporated products are specifically not authorized for use as critical components in life support devices or systems without the express written approval of the Chief Executive Officer of Diodes Incorporated. As used herein:

A. Life support devices or systems are devices or systems which:

1. are intended to implant into the body, or
2. support or sustain life and whose failure to perform when properly used in accordance with instructions for use provided in the labeling can be reasonably expected to result in significant injury to the user.

B. A critical component is any component in a life support device or system whose failure to perform can be reasonably expected to cause the failure of the life support device or to affect its safety or effectiveness.

Customers represent that they have all necessary expertise in the safety and regulatory ramifications of their life support devices or systems, and acknowledge and agree that they are solely responsible for all legal, regulatory and safety-related requirements concerning their products and any use of Diodes Incorporated products in such safety-critical, life support devices or systems, notwithstanding any devices- or systems-related information or support that may be provided by Diodes Incorporated. Further, Customers must fully indemnify Diodes Incorporated and its representatives against any damages arising out of the use of Diodes Incorporated products in such safety-critical, life support devices or systems.

Copyright © 2014, Diodes Incorporated

www.diodes.com