

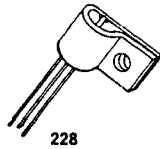

112



195.1



228

## PHASE CONTROL SCR's .5 TO 5 AMPERES

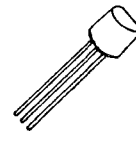

263

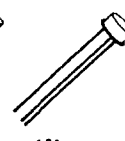

101

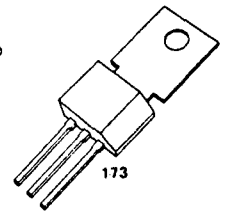

173

GE TYPE	C3	C103	C203	C5	C6	C7	—	C106	C107	C108
<b>JEDEC</b>	2N877-81 <sup>(1)</sup>	—	2N5060-64	2N2322-29	—	2N2344-48	2N1595-99, A	—	—	—
<b>ELECTRICAL SPECIFICATIONS</b>										
<b>VOLTAGE RANGE</b>	30-200	30-200	30-400	25-400	25-400	25-200	50-400	15-600	15-600	15-600
<b>FORWARD CONDUCTION</b>										
$I_{T(RMS)}$	Max. RMS on-state current (A)									
	0.5	0.8	0.8	1.6	1.6	1.6	1.6	4.0	4.0	5.0
$I_{T(AV)}$	Max. average on-state current @ 180° conduction (A) @ $T_C$									
	0.32 @ 85°C	0.50 @ 25°C	0.50 @ 25°C	1.0 @ 85°C	1.0 @ 85°C	1.0 @ 55°C	1.0 @ 110°C	2.5 @ 30°C	2.5 @ 20°C	3.75 @ 30°C
$I_{TSM}$	Max. peak one cycle, non-repetitive surge current (A)									
	7	8	8	15	10	15	15	20	15	30
$I^2t$	Max. $I^2t$ for fusing for > 1.5 msec (A <sup>2</sup> sec)									
	—	—	—	0.5	0.5	—	0.5	0.5	0.5	1
$V_{TM}$	Max. peak on-state voltage @ 25°C, 180° conduction, rated $I_{T(AV)}$ (V)									
	1.6	1.5	1.5	2.2	1.4	2	2	2.2	2.5	1.35
$R_{\theta JC}$	Max. internal thermal resistance, dc junction-to-case (°C/W)									
	80	125	75	10	10	—	—	10	10	10
$I_H$	Max. holding current @ 25°C (mA)									
	5	5	5	2	5	1	—	3	6	3
$t_q$	Typical turn-off time (μsec) @ max. $T_J$									
	15	15	15	40	40	20	40	40	40	40
	Maximum turn-off time (μsec @ 110°C)									
	—	—	—	—	—	—	—	100	100	100
$t_d + t_r$	Typical turn-on time (μsec @ 110°C)									
	1	1.4	1.4	1.4	1.4	1.4	1.2	1	1	1
$di/dt$	Max. rate-of-rise of turned-on current (A/μsec)									
	—	—	—	50	—	—	—	50	50	50
$T_J$	Junction operating temperature range (°C)									
	-65 to 125	-65 to 125	-65 to 125	-65 to 125	-40 to 125	-65 to 100	-65 to 150	-40 to 110	-40 to 110	-40 to 110
<b>BLOCKING</b>										
$dv/dt$	Typical critical rate-of-rise of off-state voltage, exponential to rated $V_{DRM}$ @ max. rated $T_J$ (V/μsec)									
	40	20	20	20	20	20	20	8	8	8
<b>FIRING</b>										
$I_{GT}$	Max. required gate current to trigger (μA) @ -65°C									
	300	500	500	350	—	75	—	—	—	—
	@ -40°C									
	—	—	—	—	—	—	—	500	—	500
	@ 25°C									
	200	200	200	200	1000	20	10,000	200	500	200
$V_{GT}$	Max. required gate voltage to trigger (V) @ -65°C									
	—	1	1	1	1	1	—	—	—	—
	@ -40°C									
	—	—	—	—	1	—	—	1	—	1
	@ 25°C									
	0.8	0.8	0.8	0.8	0.8	0.8	3	0.8	0.8	0.8
$V_{GT}$	Min. required gate voltage to trigger (V) @ 110°C									
	—	—	—	—	—	—	—	0.2	0.2	0.2
	@ 125°C									
	0.05	0.1	0.1	0.1	0.1	—	—	—	—	—
<b>VOLTAGE TYPES</b>										
Repetitive Peak Forward and Reverse Voltages										
15	—	—	—	—	—	—	—	C106Q1	C107Q1	C108Q1
25	—	—	—	2N2322 C5U	C6U	2N2344	—	—	—	—
30	2N877	C103Y	2N5060 C203Y	—	—	—	—	C106Y1	C107Y1	C108Y1
50	—	—	—	2N2323* C5F	C6F	2N2345	2N1595, A	C106F1	C107F1	C108F1
60	2N878	C103YY	2N5061 C203YY	—	—	—	—	—	—	—
100	2N879	C103A	2N5062 C203A	2N2324* C5A	C6A	2N2346	2N1596, A	C106A1	C107A1	C108A1
150	2N890	—	2N5063	2N2325 C5G	C6G	2N2347	—	—	—	—
200	2N881	C103B	2N5064 C203B	2N2326* C5B	C6B	2N2348	2N1597, A	C106B1	C107B1	C108B1
250	—	—	—	2N2327 C5H	—	—	—	—	—	—
300	—	—	C203C	2N2328* C5C	C6C	—	2N1598, A	C106C1	C107C1	C108C1
400	—	—	C203D	2N2329* C5D	C6D	—	2N1599, A	C106D1	C107D1	C108D1
500	—	—	—	—	—	—	—	C106E1	C107E1	C108E1
600	—	—	—	—	—	—	—	C106M1	C107M1	C108M1
<b>PACKAGE OUTLINE NO.</b>	112	195.1, 228	263	101	101	101	101	173	173	173

\* JAN & JANTX types available.

1. 2N885-89 available 20 mA max.  $I_{GT}$ .

2. 2N2322A-28A available 20 mA max.  $I_{GT}$ .

# SCR

2N877-81

2N885-89

## FEATURES:

- All-diffused for Proved Reliability
- Miniature Package TO-18
- Two Ranges of Gate Sensitivity:  
2N877-881 — 200  $\mu$ a max.  
2N885-889 — 20  $\mu$ a max.
- Low Holding Current:  
2N877-881 — 5 ma. max.  
2N885-889 — 3 ma. mas.
- Voltage Ratings up to 200 volts
- Designed for Military Applications

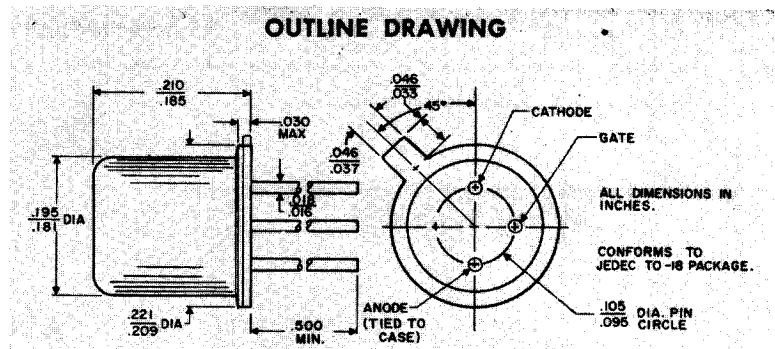
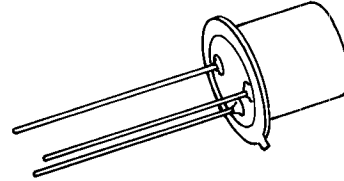

## MAXIMUM ALLOWABLE RATINGS

TYPES	PEAK FORWARD BLOCKING VOLTAGE, $V_{FBM}$ , $T_J = -65^\circ\text{C to } +125^\circ\text{C}$ . $R_{GK} = 1000 \text{ OHMS MAXIMUM}$ .	WORKING AND REPETITIVE PEAK REVERSE VOLTAGE, $V_{ROM}(\text{wkg})$ and $V_{ROM}(\text{rep})$ . $T_J = -65^\circ\text{C to } +150^\circ\text{C}$	NON-REPETITIVE PEAK REVERSE VOLTAGE, $V_{ROM}(\text{non-rep}) < 5 \text{ Milliseconds}$ . $T_J = -65^\circ\text{C to } +125^\circ\text{C}$
2N877, 2N885	30 volts	30 volts	45 volts
2N878, 2N886	60 volts	60 volts	90 volts
2N879, 2N887	100 volts	100 volts	130 volts
2N880, 2N888	150 volts	150 volts	200 volts
2N881, 2N889	200 volts	200 volts	275 volts

Peak Forward Voltage, PFV \_\_\_\_\_ 300 Volts  
 RMS Forward Current, On-state \_\_\_\_\_ 0.5 Ampere  
 Average Forward Current, On-state \_\_\_\_\_ Depends on conduction angle (see charts 2, 3, 11 & 12)  
 Peak One Cycle Surge Forward Current (Non-repetitive),  $I_{FM}$  (surge) \_\_\_\_\_ 7 Amperes  
 Peak Forward Gate Power Dissipation,  $P_{GM}$  \_\_\_\_\_ 0.1 Watt  
 Average Forward Gate Power Dissipation,  $P_{G(AV)}$  \_\_\_\_\_ 0.01 Watt  
 Peak Gate Voltage, Forward and Reverse,  $V_{GFM}$  and  $V_{GRM}$  \_\_\_\_\_ 6 Volts  
 Storage Temperature,  $T_{stg}$  \_\_\_\_\_  $-65^\circ\text{C to } +150^\circ\text{C}$   
 Operating Temperature \_\_\_\_\_  $-65^\circ\text{C to } +150^\circ\text{C}$

## CHARACTERISTICS

TEST	SYMBOL	MIN.	TYP.	MAX.	UNITS	TEST CONDITIONS
FORWARD BLOCKING CURRENT 2N877-2N881	$I_{FX}$	—	0.03	10	$\mu\text{A dc}$	$V_{FX} = \text{Rated } V_{FXM}, R_{GK} = 1000 \text{ ohms}$
		—	10	100		$T_J = +25^\circ\text{C}$
		—	0.03	1		$T_J = +125^\circ\text{C}$
		—	10	20		$T_J = +25^\circ\text{C}$
REVERSE BLOCKING CURRENT 2N877-2N881	$I_{RX}$	—	0.1	10	$\mu\text{A dc}$	$V_{RX} = \text{Rated } V_{ROM} \text{ (rep)}$
		—	10	100		$T_J = +25^\circ\text{C}$
		—	0.1	1		$T_J = +125^\circ\text{C}$
		—	10	20		$T_J = +25^\circ\text{C}$
2N885-2N889	$I_{RX}$	—	0.1	1	$\mu\text{A dc}$	$V_{RX} = \text{Rated } V_{ROM} \text{ (rep)}$
—		10	20	$T_J = +25^\circ\text{C}$		
—		0.1	1	$T_J = +125^\circ\text{C}$		
—		10	20	$T_J = +25^\circ\text{C}$		
REVERSE GATE CURRENT	$I_{GRM}$	—	1	10	$\mu\text{A dc}$	$V_{GRM} = 2 \text{ Volts}, T_J = +25^\circ\text{C}$
PEAK ON-VOLTAGE	$V_{FM}$	—	1.3	1.9	volts	$T_J = +25^\circ\text{C}, I_{FM} = 1 \text{ Ampere}$ , single half sine wave pulse, 2.0 milliseconds wide max.
HOLDING CURRENT 2N877-2N881	$I_{HX}$	0.4	1.7	5.0	mA dc	$T_J = +25^\circ\text{C}, R_{GK} = 1000 \text{ ohms}$ , $V_{FX} = 24 \text{ Volts dc}$ .
		0.4	1.1	3.0		
2N885-2N889	$I_{HX}$	0.4	1.1	3.0	mA dc	$T_J = +25^\circ\text{C}, R_{GK} = 1000 \text{ ohms}$ , $V_{FX} = 24 \text{ Volts dc}$ .
RATE OF RISE OF APPLIED FORWARD VOLTAGE	$dv/dt$	—	40	—	volts/ $\mu\text{sec}$	$T_J = +125^\circ\text{C}, R_{GK} = 1000 \text{ ohms}$ , $V_{FXM} = \text{Rated } V_{FXM}$
TURN-ON TIME (Delay Time + Rise Time)	$t_d + t_r$	—	1.0	—	$\mu\text{sec}$	$T_J = +25^\circ\text{C}, V_{FX} = \text{Rated } V_{FXM}$ , $I_{FM} = 1 \text{ Ampere}$ , Gate Supply: 6 Volts, 300 ohms
CIRCUIT COMMUTATED TURN-OFF TIME All Types	$t_{off}$	—	15	—	$\mu\text{sec}$	$T_J = +125^\circ\text{C}, R_{GK} = 1000 \text{ ohms}$ , $I_{FM} = 1 \text{ Ampere}, I_R \text{ (recovery)} = 1 \text{ Ampere}$ Reapplied $V_{FXM} = \text{Rated}$ , Rate of Rise of Reapplied Forward Blocking Voltage = 20 V/ $\mu\text{sec}$
GATE TRIGGER CURRENT 2N877-2N881	$I_{GT}$	—	40	200	$\mu\text{A dc}$	$V_{FX} = 6 \text{ Vdc}, R_{GK} = 1000 \text{ ohms}$ , $R_L = 100 \text{ ohms maximum}$ .
		—	10	20		$T_J = +25^\circ\text{C}$
2N885-2N889	$I_{GT}$	—	10	20	$\mu\text{A dc}$	$T_J = +25^\circ\text{C}$
GATE TRIGGER VOLTAGE 2N877-2N881	$V_{GT}$	0.4	0.5	0.8	Vdc	$V_{FX} = 6 \text{ Vdc}, R_{GK} = 1000 \text{ ohms}$ , $R_L = 100 \text{ ohms maximum}$ .
		0.44	0.5	0.6		$T_J = +25^\circ\text{C}$
		0.05	—	—		$V_{FX} = \text{Rated } V_{FXM}, R_{GK} = 1000 \text{ ohms}$ , $T_J = +125^\circ\text{C}$
2N885-2N889	$V_{GT}$	0.44	0.5	0.6	Vdc	$T_J = +25^\circ\text{C}$
All Types	$V_{GT}$	0.05	—	—	Vdc	$V_{FX} = \text{Rated } V_{FXM}, R_{GK} = 1000 \text{ ohms}$ , $T_J = +125^\circ\text{C}$

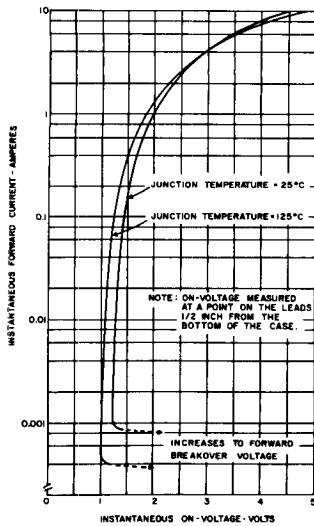

**1. MAXIMUM FORWARD CHARACTERISTICS, ON-STATE**

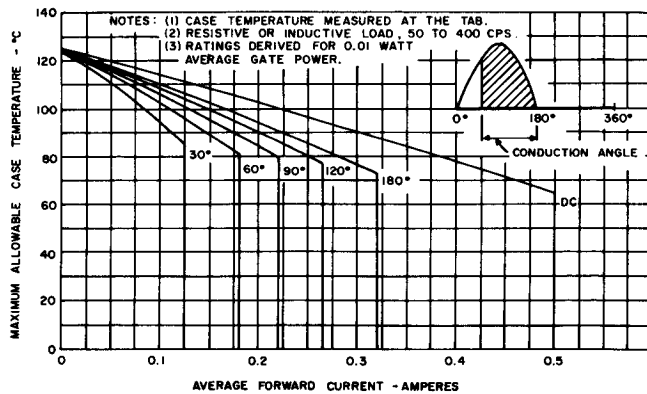

**2. MAXIMUM ALLOWABLE CASE TEMPERATURE (125°C JUNCTION TEMP.)**

2N877-81

2N885-89

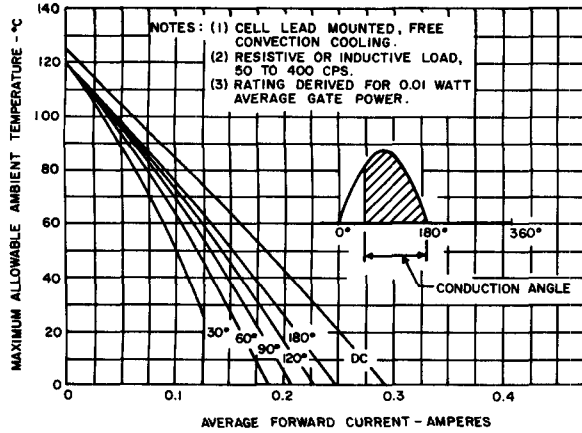

3. MAXIMUM ALLOWABLE AMBIENT TEMPERATURE (125°C JUNCTION TEMP.)

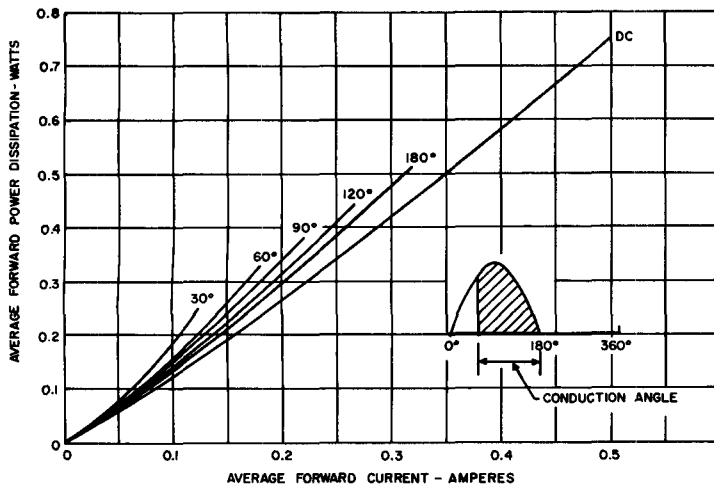

4. FORWARD POWER DISSIPATION

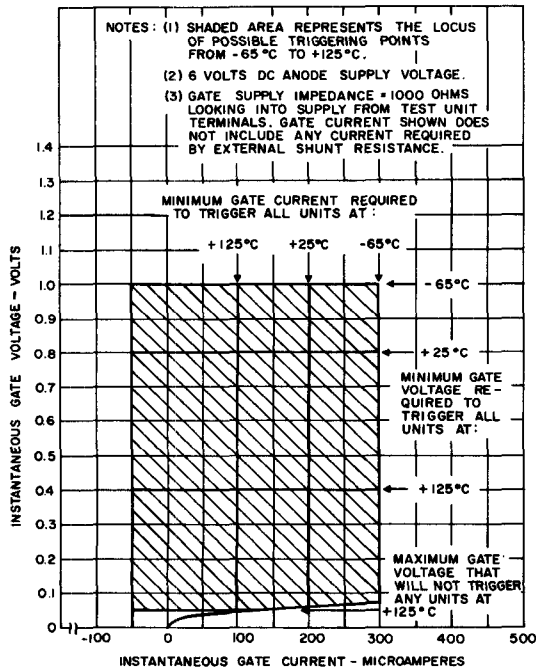

5. GATE TRIGGERING CHARACTERISTICS (2N877-2N881)

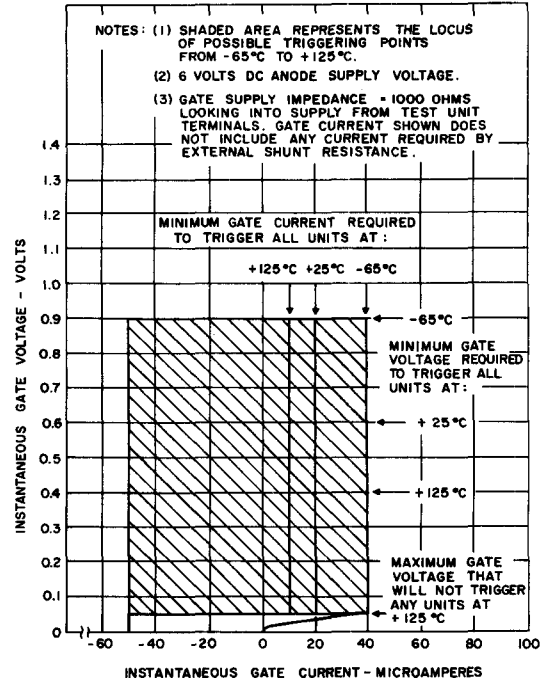

6. GATE TRIGGERING CHARACTERISTICS (2N885-2N889)

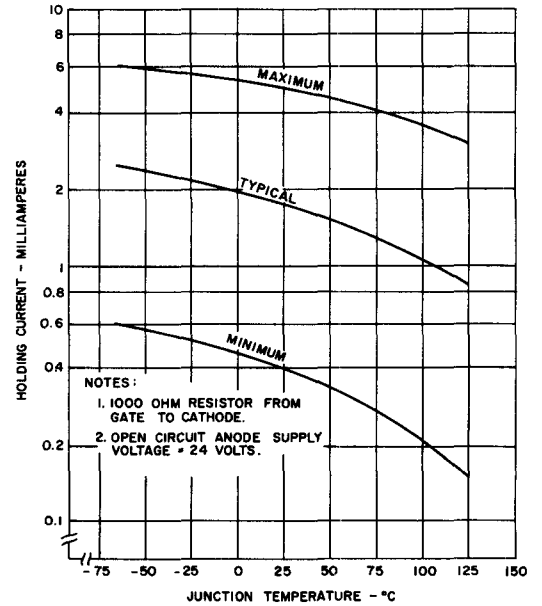

7. HOLDING CURRENT AS A FUNCTION OF JUNCTION TEMPERATURE (2N877-2N881)

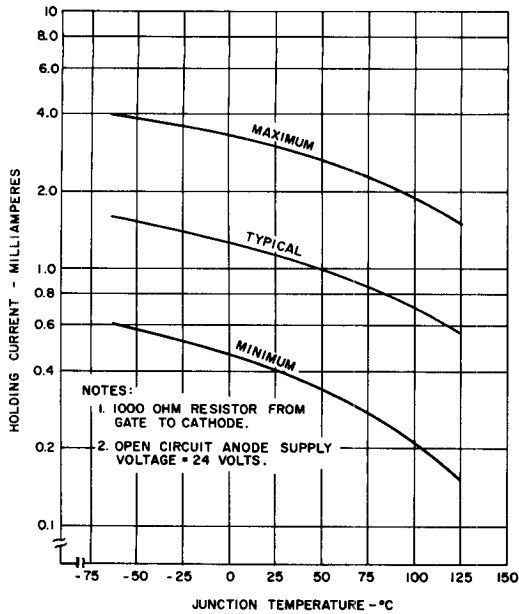

8. HOLDING CURRENT AS A FUNCTION OF JUNCTION TEMPERATURE (2N885-2N889)

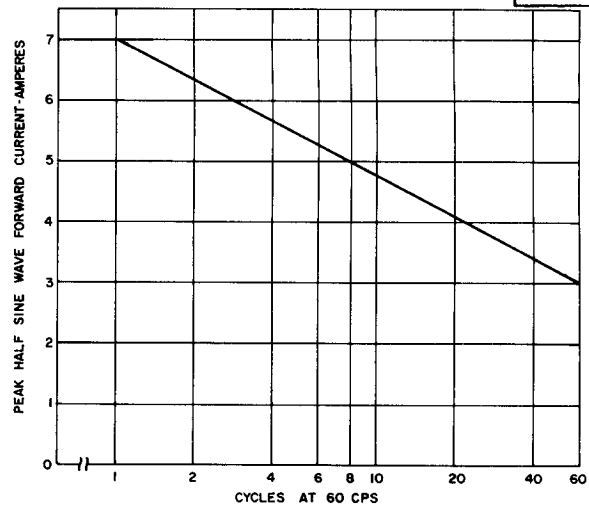

9. MAXIMUM ALLOWABLE NON-RECURRENT SURGE CURRENT AT RATED LOAD CONDITIONS

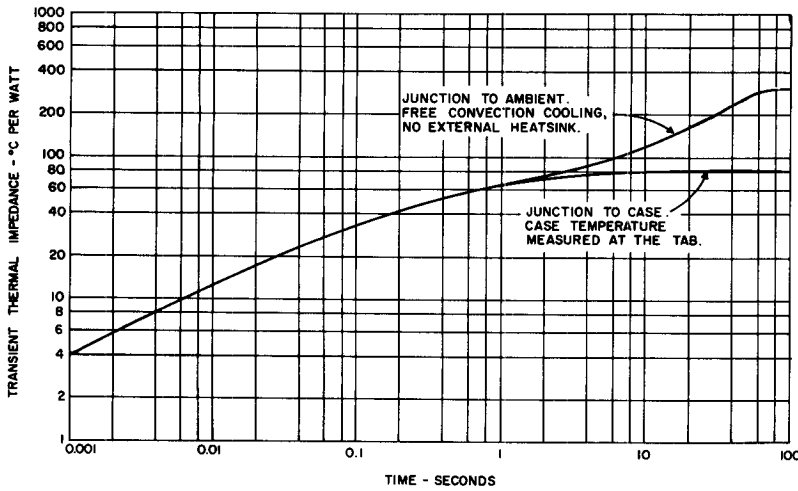

10. MAXIMUM TRANSIENT THERMAL IMPEDANCE

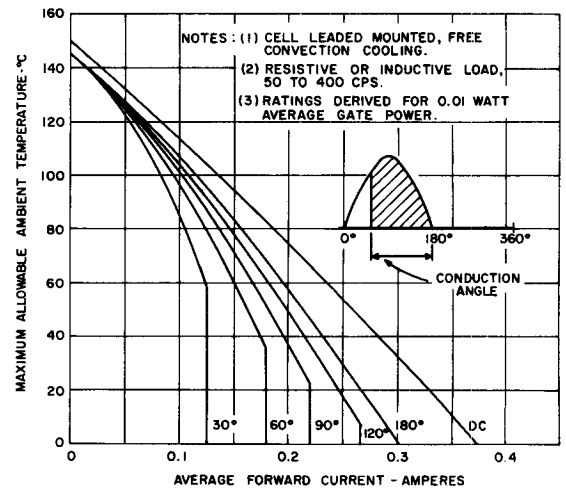

11. MAXIMUM ALLOWABLE AMBIENT TEMPERATURE (150°C JUNCTION TEMP.)

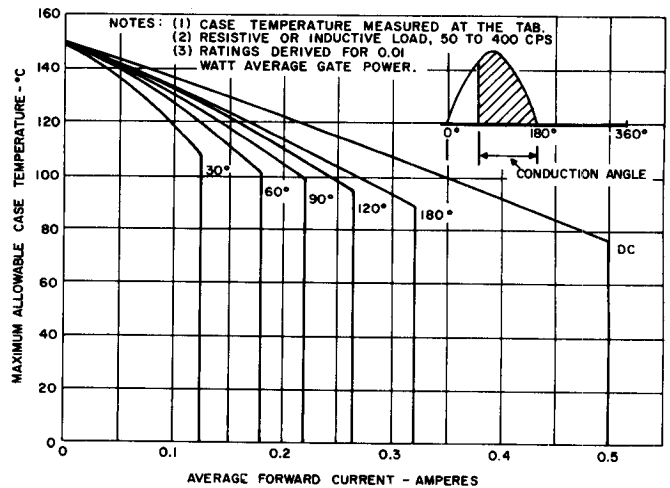

12. MAXIMUM ALLOWABLE CASE TEMPERATURE (150°C JUNCTION TEMP.)

Charts 11 and 12 apply to latching applications where SCR need not block forward voltage after being turned on, since the  $V_{FXM}$  rating does not apply above 125°C junction temperature. SCR will again block rated forward voltage after junction temperature drops below 125°C.