

Surface  
**SMT**  
Mount

# .025" SQ SMT SOCKET SSM SERIES



**Mates with:**  
TSW, MTSW, TST,  
TSS, ZST, ZSS, DW,  
EW, ZW, TSM

## SPECIFICATIONS

For complete specifications see [www.samtec.com?SSM](http://www.samtec.com?SSM)

**Insulator Material:**  
Black Liquid Crystal Polymer



**Contact Material:**  
Phosphor Bronze



**Plating:** Au, PdNi or Sn over 50µ" (1,27µm) Ni

**Current Rating:**

3A @ 80°C ambient (-DV/-SV mated with TSM-DV)  
4A @ 80°C ambient (-DH/-SH mated with TSW-D)

**Voltage Rating:**

475 VAC (-SV/-DV mated with TSW)  
450 VAC (-SH/-DH mated with TSM)

**Operating Temp Range:**  
-55°C to +125°C with Gold  
-55°C to +105°C with Tin

**Contact Resistance:**  
10 mΩ max

**Insertion Depth:**  
SV/DV is (4,34mm) .171" to (7,24mm) .285" or pass-through from top; (5,56mm) .219" plus board thickness minimum from bottom; SH/DH is (4,34mm) .171" to (6,35mm) .250"

**Insertion Force:**  
(Single contact only)  
5oz (1,39N) average

**Normal Force:**  
125 grams (1,21N) average

**Withdrawal Force:**  
(Single contact only)  
2oz (0,56N) average

**Processing:**

**Max Processing Temp:**  
230°C for 60 seconds, or 260°C for 20 seconds 3x with Matte Sn

**Lead-Free Solderable:**  
Yes, with Matte Sn plating

**-DH Coplanarity:**  
Less than 28 positions (0,15mm) .006" max  
More than 27 positions (0,20mm) .008" max

**-SH, -SV, -DV Coplanarity:**  
(0,15mm) .006" max

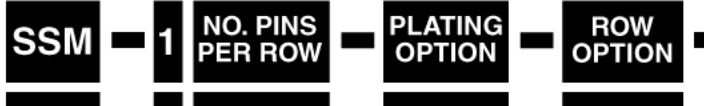

**02 thru 36**

**-S or -SM**  
= 30µ" (0,76µm) Gold on contact, Tin (-S) or Matte Tin (-SM) on tail

**-L or -LM**  
= 10µ" (0,25µm) Gold on contact, Tin (-L) or Matte Tin (-LM) on tail

**APPLICATION SPECIFIC OPTION**  
Alignment Pin available. Call Samtec.

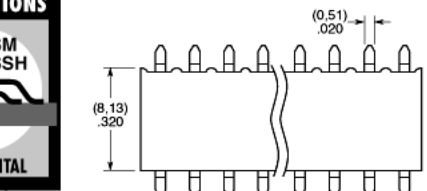
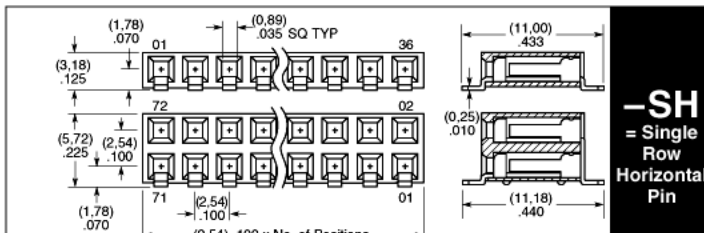
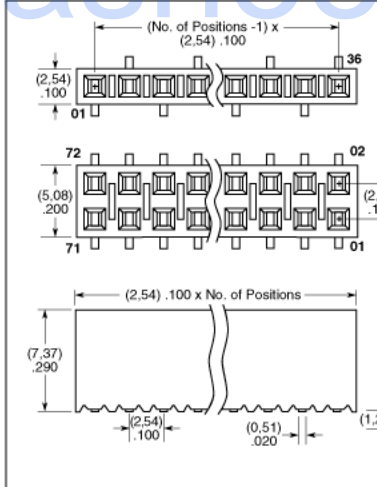
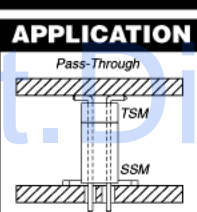

**-BE**  
= Bottom Entry (-DV & -SV only)

**-M**  
= Metal Pick & Place Pad (5 positions min.) -DV only

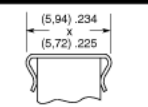

**-LC**  
= Locking Clip (-DV & -SV only)  
Contact Samtec for -DH & -SH

**-K**  
= (6,50mm) .256" DIA Polyimide film Pick & Place Pad (5 positions min.) -DV & -SV only

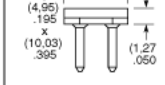

**-P**  
= Plastic Pick & Place Pad (-DV & -SV only) (5 pos. minimum)

**-TR**  
= Tape & Reel Packaging (29 positions max.)

## SUGGESTED PCB LAYOUTS

For reference only. Please contact Samtec or go to [www.samtec.com?SSM](http://www.samtec.com?SSM) for recommended PCB layout.

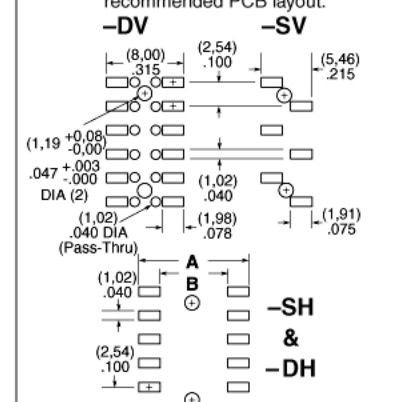

Row Option	A	B
-SH	(12,19) .480	(8,38) .330
-DH	(11,68) .460	(7,11) .280

**Note:** Some lengths, styles and options are non-standard, non-returnable.



Due to technical progress, all designs, specifications and components are subject to change without notice.

[WWW.SAMTEC.COM](http://WWW.SAMTEC.COM)