

DESCRIPTION

The LM101, LM201, LM101A, LM201A, and LM301A are high performance operational amplifiers featuring high gain, short circuit protection, simplified compensation and excellent temperature stability.

The LH2101A, LH2201A, LH2301A are dual amplifier using two LM101A type devices in the same hermetic package. All electrical specifications are the same as the single amplifiers.

FEATURES

- Short circuit protection
- Offset voltage null capability
- Large common-mode and differential voltage ranges
- Low power consumption
- No latch up
- LM101, LM101A Mil std 883A,B,C available
- LM101A Mil std 38510 (JAN) planned, Mil std M38510 processing available

PIN CONFIGURATIONS

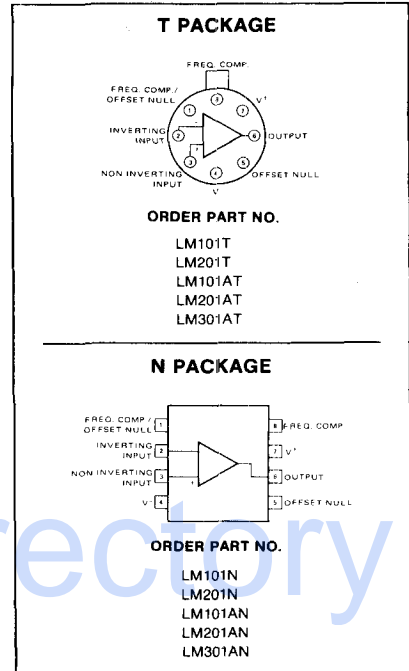
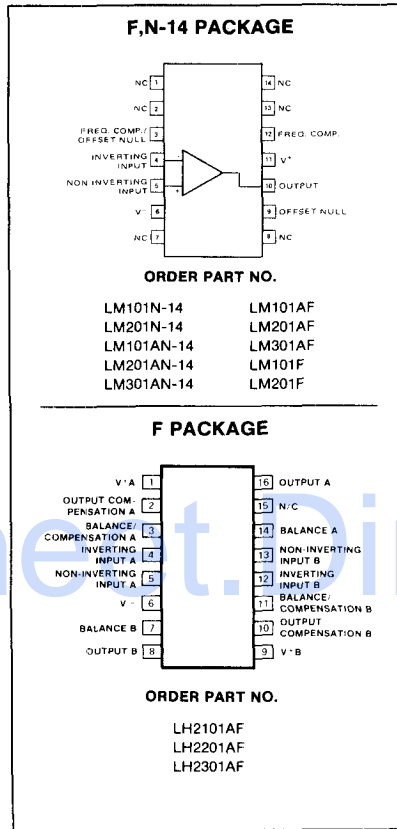

EQUIVALENT SCHEMATIC

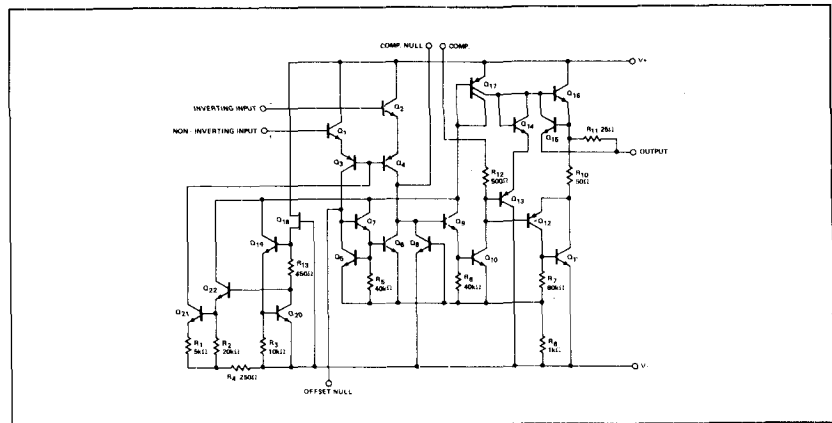

ABSOLUTE MAXIMUM RATINGS

PARAMETER	RATING	UNIT
Supply Voltage LH2101A, LH2201A, LM101, LM201, LM101A, LM201A LM301A, LH2301A	±22	V
Power dissipation ¹	500	mW
Differential input voltage	±30	V
Input voltage ²	±15	V
Output short circuit duration	Indefinite	
Operating temperature range LM101, LM101A, LH2101A LM201A, LH2201A LM201, LM301A, LH2301A	-55 to +125 -25 to +85 0 to +70	°C °C °C
Storage temperature range	-65 to +150	°C
Lead temperature (soldering 60sec)	300	°C

NOTES

1. Absolute maximum rating holds for all packages. The maximum junction temperature is 150°C for the LM101 and 100°C for the LM201. For operation at elevated temperatures, derate according to appropriate thermal resistances given under package information.
2. For supply voltages less than ±15V, the absolute maximum input voltage is equal to the supply voltage.

DC ELECTRICAL CHARACTERISTICS $T_A = 25^\circ\text{C}$, $\pm 5\text{V} \leq V_S \leq +20\text{V}$ unless otherwise specified.*

PARAMETER	TEST CONDITIONS	LM101			LM201			UNIT
		Min	Typ	Max	Min	Typ	Max	
V_{OS} Offset voltage	$R_S \leq 10\text{k}\Omega$, $C_1 = 30\text{pF}$ Over temp.		1.0	5.0 6.0		2.0	7.5 10	mV mV
V_{OS} Drift	$R_S \leq 50\Omega$, $C_1 = 30\text{pF}$ $R_S \leq 10\text{k}\Omega$		3.0 6.0			6 10		$\mu\text{V}/^\circ\text{C}$ $\mu\text{V}/^\circ\text{C}$
I_{OS} Offset current	$C_1 = 30\text{pF}$ $T_A = \text{high}$, $C_1 = 30\text{pF}$ $T_A = \text{low}$ Over temp. $T_A = +70^\circ\text{C}$ $T_A = 0^\circ\text{C}$		40 10 100	200 200 500		100 50 150	500 400 750	nA nA nA nA nA nA
I_{BIAS} Input current	$C_1 = 30\text{pF}$ $T_A = -55^\circ\text{C}$, $C_1 = 30\text{pF}$ $T_A = 0^\circ\text{C}$		120 280	500 1500		250 320	1500 2000	nA nA nA
V_{CM} Common mode voltage range	Over temp., $V_S = \pm 15\text{V}$, $C_1 = 30\text{pF}$	±12			±12			V
CMRR Common mode rejection ratio	$R_S \leq 10\text{k}\Omega$, $C_1 = 30\text{pF}$, over temp.	70	90		65	90		dB
R_{IN} Input resistance	$C_1 = 30\text{pF}$	0.3	0.8		0.1	0.4		MΩ
A_{VOL} Large signal voltage gain	$R_L \geq 2\text{k}\Omega$, $V_{OUT} \pm 10\text{V}$, $V_S = \pm 15\text{V}$ Over temp.	50 25	160		20 15	150		V/mV V/mV
Supply current	$V_S = \pm 20\text{V}$		1.8	3.0		1.8	3.0	mA

***NOTE**

Unless otherwise specified, all specifications for LM301A are $\pm 5\text{V} \leq V_S \leq \pm 15\text{V}$.

DC ELECTRICAL CHARACTERISTICS (Cont'd) $T_A = 25^\circ\text{C}$, $\pm 5\text{V} \leq V_S \leq +20\text{V}$ unless otherwise specified.*

PARAMETER	TEST CONDITIONS	LM101A/LM201A/ LH2101A/LH2201A			LM301A/LH2301A			UNIT
		Min	Typ	Max	Min	Typ	Max	
V_{OS} Offset voltage	$R_S \leq 50\text{k}\Omega$, $C_1 = 30\text{pF}$ Over temp.		0.7	2.0 3.0		2.0	7.5 10	mV mV
V_{OS} Drift	$R_S = 0\Omega$, over temp.		3.0	1.5		6.0	30	$\mu\text{V}/^\circ\text{C}$
I_{OS} Offset current	$C_1 = 30\text{pF}$ Over temp.		1.5	10 20		3	50 70	nA nA
I_{OS} Drift	$+25^\circ\text{C} \leq T_A \leq T_{MAX}$, $C_1 = 30\text{pF}$ $T_{MIN} \leq T_A \leq +25^\circ\text{C}$		0.01 0.02	0.1 0.2		0.01 0.02	0.3 0.6	nA/ $^\circ\text{C}$ nA/ $^\circ\text{C}$
I_{BIAS} Input current	$C_1 = 30\text{pF}$ Over temp.		30	75 100		70	250 300	nA nA
V_{CM} Common mode voltage range	Over temp., $V_S = \pm 15\text{V}$, $C_1 = 30\text{pF}$ $V_S = \pm 20$	± 15				± 12		V V
CMRR Common mode rejection ratio	$R_S \leq 50\text{k}\Omega$, $C_1 = 30\text{pF}$, over temp.	80	96		70	90		dB
R_{IN} Input resistance	$C_1 = 30\text{pF}$	1.5	4		0.5	2		M Ω
A_{VOL} Large signal voltage gain	$R_L \geq 2\text{k}\Omega$, $V_{OUT} \pm 10\text{V}$, $V_S = \pm 15\text{V}$ Over temp.	50 25	160		25 15	160		V/mV V/mV
Supply current	$V_S = \pm 20\text{V}$ $V_S = \pm 15\text{V}$		1.8	3.0		1.8	3.0	mA mA

*NOTE

Unless otherwise specified, all specifications for LM301A are $\pm 5\text{V} \leq V_S \leq \pm 15\text{V}$.

TYPICAL PERFORMANCE CHARACTERISTICS

INPUT VOLTAGE RANGE vs SUPPLY VOLTAGE

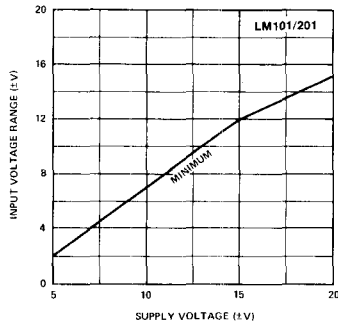

OUTPUT SWING vs SUPPLY VOLTAGE

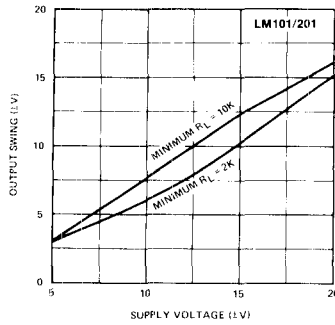

VOLTAGE GAIN vs SUPPLY VOLTAGE

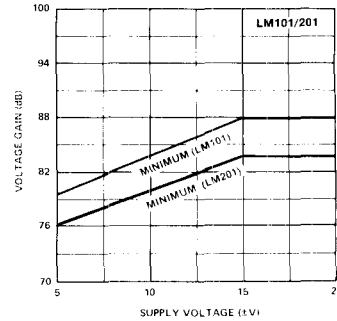

VOLTAGE GAIN

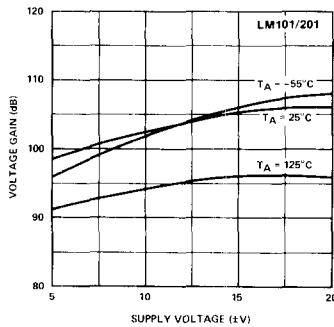

SUPPLY CURRENT

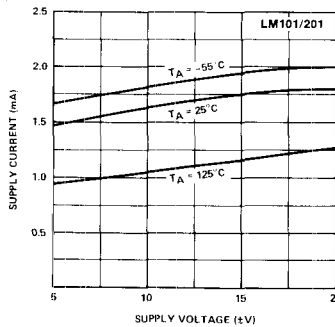

CURRENT LIMITING

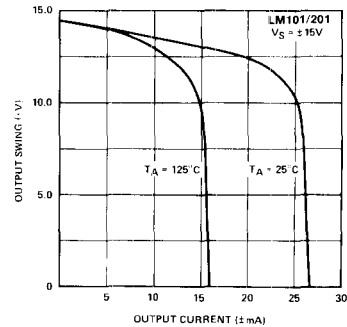

INPUT CURRENT

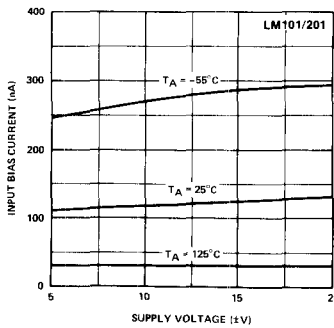

MAXIMUM POWER DISSIPATION

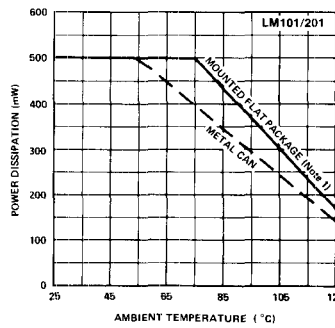

OPEN LOOP FREQUENCY RESPONSE

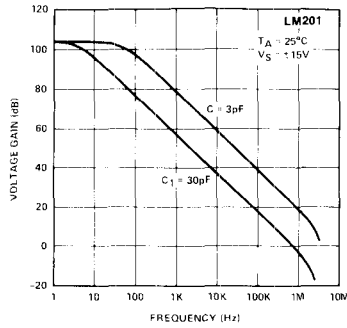

TYPICAL PERFORMANCE CHARACTERISTICS (Cont'd)

LARGE SIGNAL FREQUENCY RESPONSE

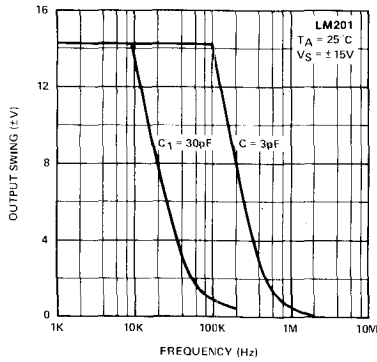

VOLTAGE FOLLOWER PULSE RESPONSE

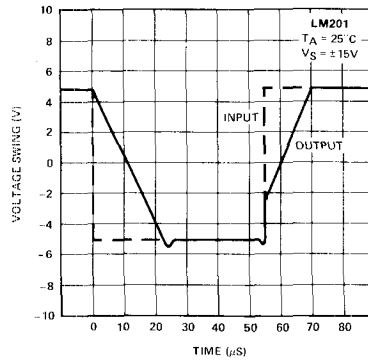

OPEN LOOP FREQUENCY RESPONSE

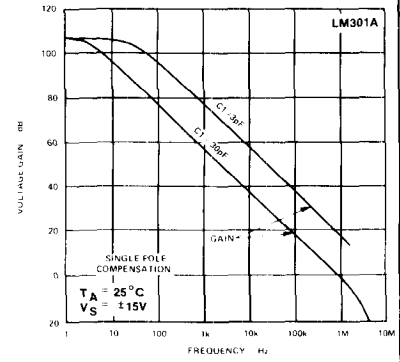

LARGE SIGNAL FREQUENCY RESPONSE

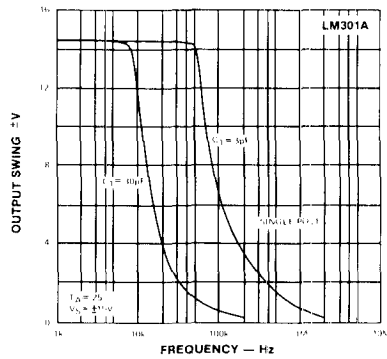

VOLTAGE FOLLOWER PULSE RESPONSE

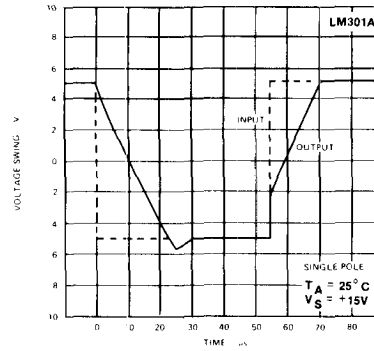

TYPICAL PERFORMANCE CHARACTERISTICS (Cont'd)

VOLTAGE GAIN

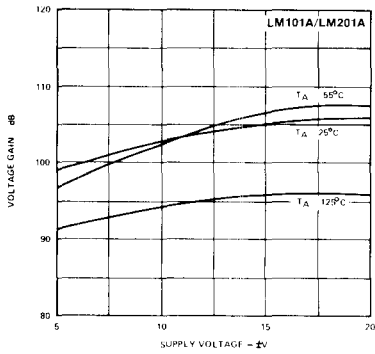

SUPPLY CURRENT

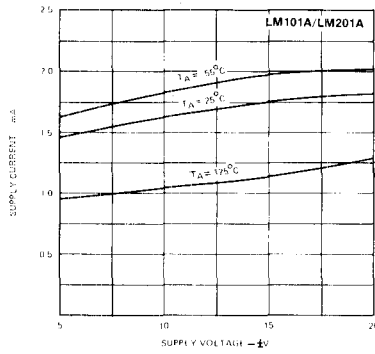

INPUT CURRENT

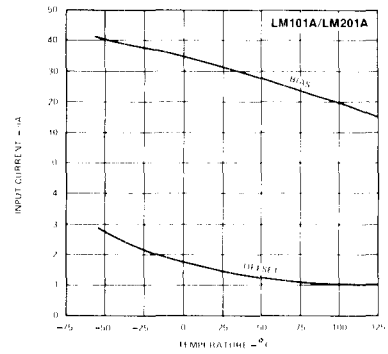

CURRENT LIMITING

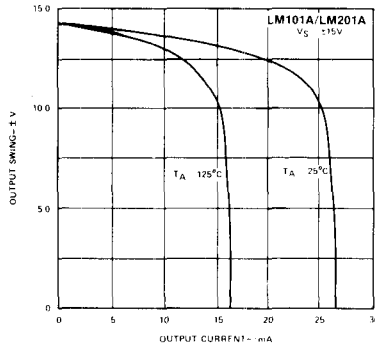

INPUT NOISE VOLTAGE

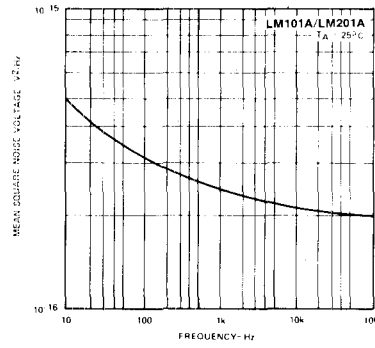

INPUT NOISE CURRENT

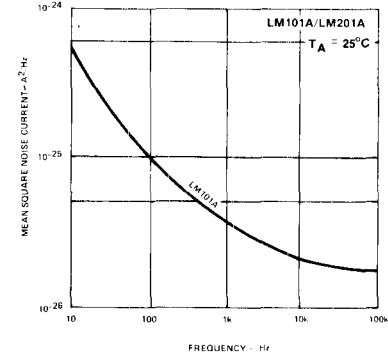

COMMON MODE REJECTION

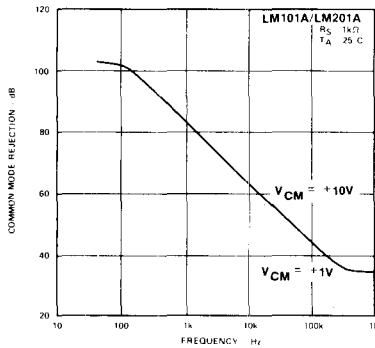

POWER SUPPLY REJECTION

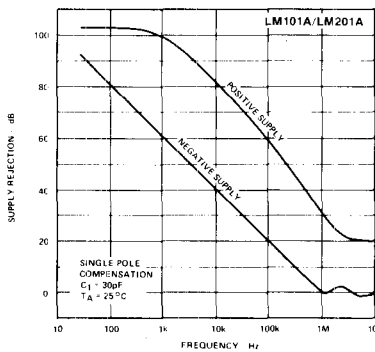

CLOSED LOOP OUTPUT IMPEDANCE

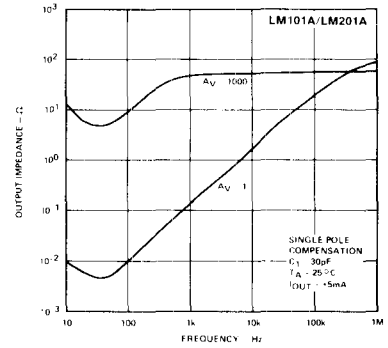

TYPICAL PERFORMANCE CHARACTERISTICS (Cont'd)

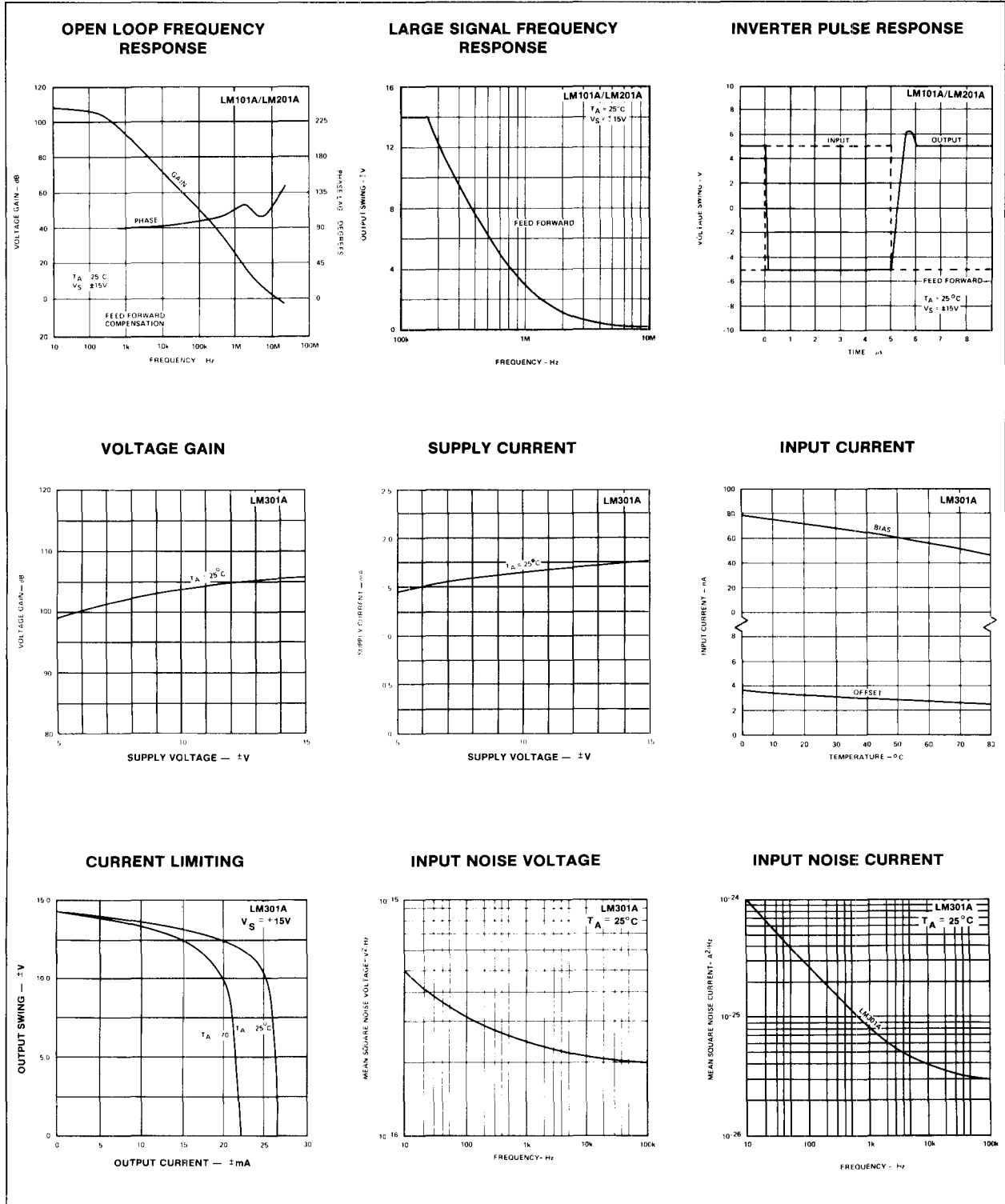

TYPICAL PERFORMANCE CHARACTERISTICS (Cont'd)

OPEN LOOP FREQUENCY RESPONSE

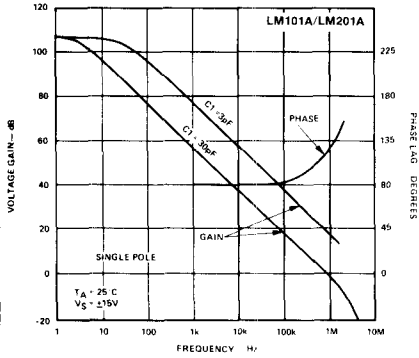

VOLTAGE FOLLOWER PULSE RESPONSE

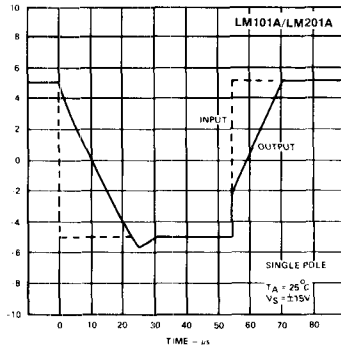

LARGE SIGNAL FREQUENCY RESPONSE

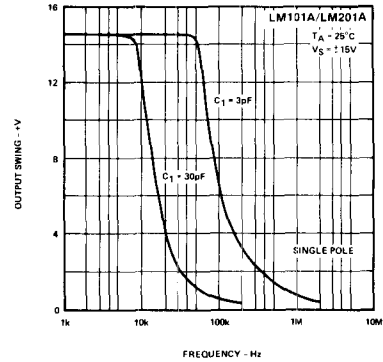

OPEN LOOP FREQUENCY RESPONSE

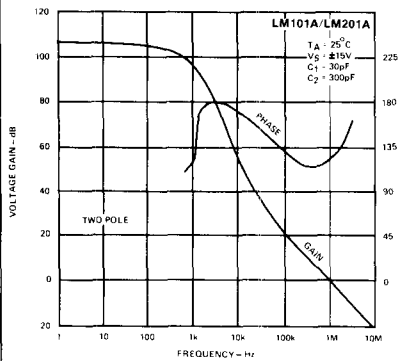

LARGE SIGNAL FREQUENCY RESPONSE

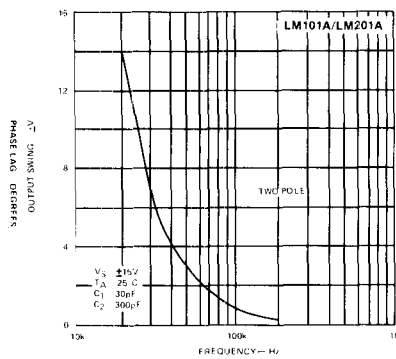

VOLTAGE FOLLOWER PULSE RESPONSE

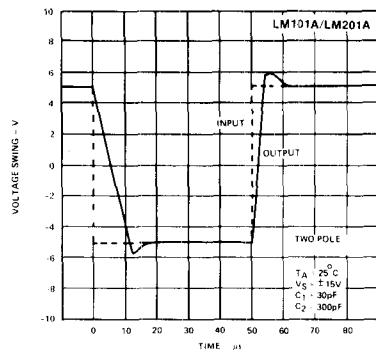

GUARANTEED PERFORMANCE CHARACTERISTICS

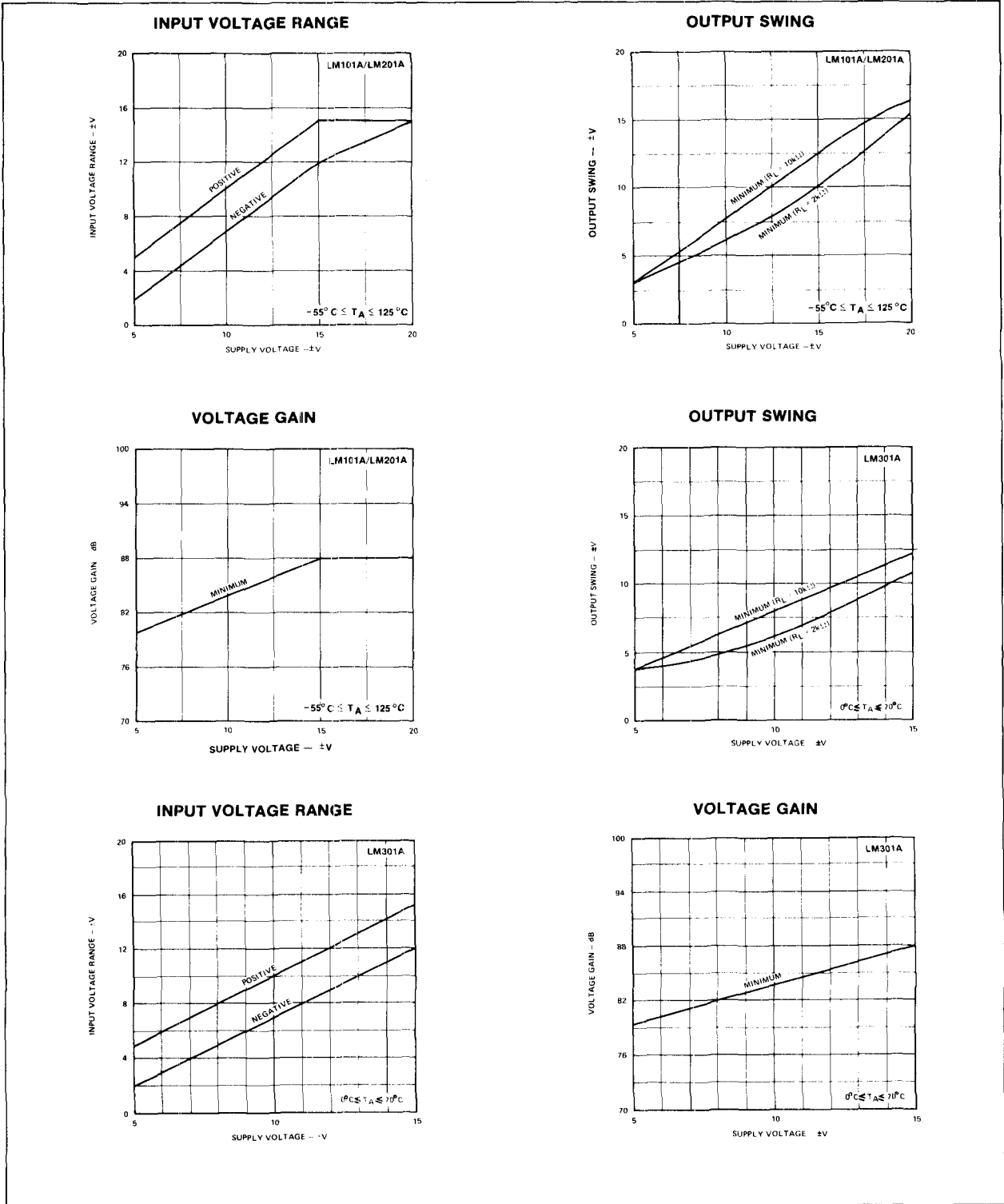

COMPENSATION CIRCUITS

SINGLE POLE COMPENSATION

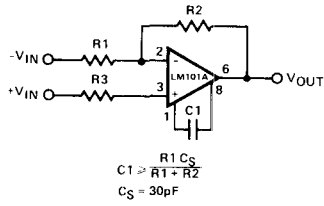

NOTE: Pin connections shown are for T package.

TWO POLE COMPENSATION

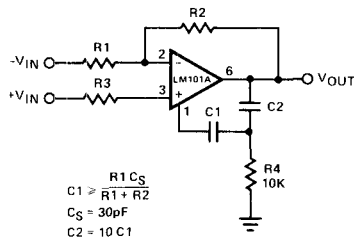

FEED FORWARD COMPENSATION

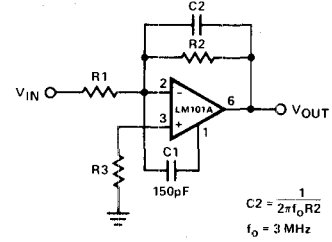

TYPICAL APPLICATIONS

INVERTING AMPLIFIER WITH BALANCING CIRCUIT

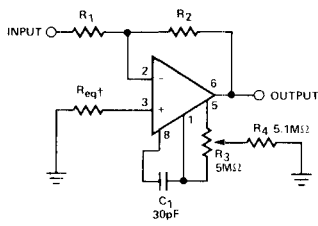

†May be zero or equal to parallel combination of R_1 and R_2 for minimum offset.

NOTE: Pin numbers shown refer to T or N package only.

LOW DRIFT SAMPLE AND HOLD

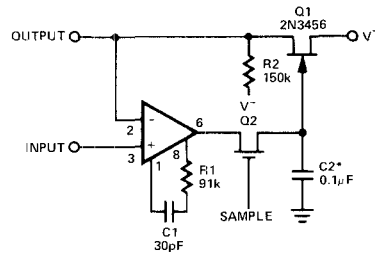

*Polycarbonate Dielectric Capacitor

NOTE: Pin numbers shown refer to T or N package only.