

LP3984 Micropower 150 mA Ultra Low-Dropout CMOS Voltage Regulator in Subminiature 4-I/O DSBGA Package

Check for Samples: [LP3984](#)

FEATURES

- Miniature 4-I/O DSBGA or SOT-23-5 Package
- Logic controlled enable
- Stable with Tantalum Capacitors
- 1 μF Tantalum Output Capacitor
- Fast Turn-On
- Thermal Shutdown and Short-Circuit Current Limit

KEY SPECIFICATIONS

- 2.5 to 6.0V Input Range
- 150 mA Output
- 60 dB PSRR at 1 kHz, 40 dB at 10 kHz @ 3.1V_{IN}
- $\leq 1.2 \mu\text{A}$ Quiescent Current when Shut Down
- Fast Turn-On Time: 20 μs (typ.)
- 75 mV typ Dropout with 150 mA Load
- -40 to $+125^\circ\text{C}$ Junction Temperature Range for Operation
- 1.5V, 1.8V, 2.9V and 3.1V

APPLICATIONS

- CDMA Cellular Handsets
- Wideband CDMA Cellular Handsets
- GSM Cellular Handsets
- Portable Information Appliances

Typical Application Circuit

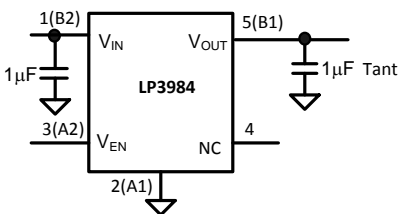

Note: Pin Numbers in parenthesis indicate DSBGA package.

DESCRIPTION

The LP3984 is designed for portable and wireless applications with demanding performance and space requirements.

The LP3984's performance is optimized for battery powered systems to deliver extremely low dropout voltage and low quiescent current. Regulator ground current increases only slightly in dropout, further prolonging the battery life.

Power supply rejection is better than 60 dB at low frequencies and starts to roll off at 10 kHz. High power supply rejection is maintained down to low input voltage levels common to battery operated circuits.

The device is ideal for mobile phone and similar battery powered wireless applications. It provides up to 150 mA from a 2.5V to 6V input. The LP3984 consumes less than 1.2 μA in disable mode and has fast turn-on time less than 20 μs .

The LP3984 is available in a 4-bump DSBGA and 5-pin SOT-23 packages. Performance is specified for -40°C to $+125^\circ\text{C}$ temperature range and is available in 1.5V, 1.8V, 2.9V and 3.1V output voltages. For other output voltage options from 1.5V to 3.5V, please contact TI sales office.



Please be aware that an important notice concerning availability, standard warranty, and use in critical applications of Texas Instruments semiconductor products and disclaimers thereto appears at the end of this data sheet.

All trademarks are the property of their respective owners.

Block Diagram

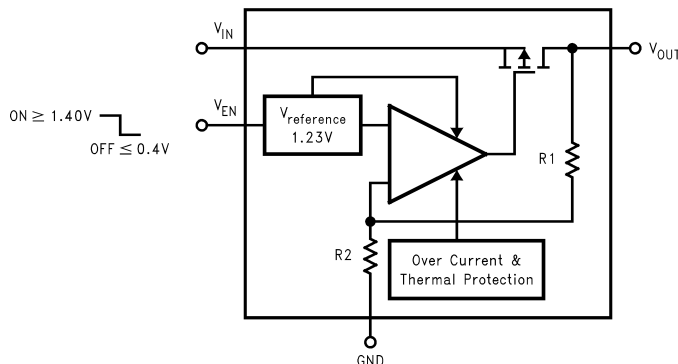

Pin Descriptions

Name	DSBGA (1)	SOT	Function
V _{EN}	A2	3	Enable Input Logic, Enable High
GND	A1	2	Common Ground
V _{OUT}	B1	5	Output Voltage of the LDO
V _{IN}	B2	1	Input Voltage of the LDO
N.C.		4	No Connection

(1) The pin numbering scheme for the DSBGA package was revised in April 2002 to conform to JEDEC standards. Only the pin numbers were revised. No changes to the physical locations of the inputs/outputs were made. For reference purposes, the obsolete numbering scheme had GND as pin 1, V_{OUT} as pin 2, V_{IN} as pin 3 and V_{EN} as pin 4.

Connection Diagram

SOT-23-5 Package

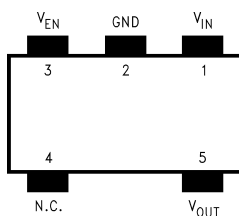

Figure 1. Top View
See Package Number DBV

DSBGA, 4-Bump Package

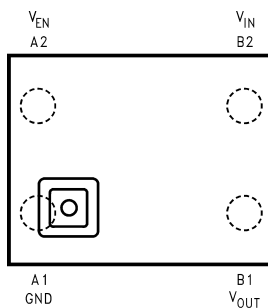

Figure 2. Top View
See Package Number YPB0004



These devices have limited built-in ESD protection. The leads should be shorted together or the device placed in conductive foam during storage or handling to prevent electrostatic damage to the MOS gates.

ABSOLUTE MAXIMUM RATINGS⁽¹⁾⁽²⁾⁽³⁾

V_{IN}, V_{EN}		-0.3 to 6.5V
V_{OUT}		-0.3 to $(V_{IN}+0.3) \leq 6.5V$
Junction Temperature		150°C
Storage Temperature		-65°C to +150°C
Lead Temp.		235°C
Pad Temp. ⁽⁴⁾		235°C
Maximum Power Dissipation ⁽⁵⁾	SOT-23-5	364 mW
	DSBGA	235 mW
ESD Rating ⁽⁶⁾	Human Body Model	2kV
	Machine Model	200V

- (1) Stresses beyond those listed under absolute maximum ratings may cause permanent damage to the device. These are stress ratings only, and functional operation of the device at these or any other conditions beyond those indicated under recommended operating conditions is not implied. Exposure to absolute-maximum-rated conditions for extended periods may affect device reliability.
- (2) All voltages are with respect to the potential at the GND pin.
- (3) If Military/Aerospace specified devices are required, please contact the Texas Instruments Sales Office/ Distributors for availability and specifications.
- (4) Additional information on pad temperature can be found in the TI AN-1112 Application Report ().
- (5) The Absolute Maximum power dissipation depends on the ambient temperature and can be calculated using the formula: $P_D = (T_J - T_A)/\theta_{JA}$, where T_J is the junction temperature, T_A is the ambient temperature, and θ_{JA} is the junction-to-ambient thermal resistance. The 364 mW rating for SOT23-5 appearing under Absolute Maximum Ratings results from substituting the Absolute Maximum junction temperature, 150°C, for T_J , 70°C for T_A , and 220°C/W for θ_{JA} . More power can be dissipated safely at ambient temperatures below 70°C. Less power can be dissipated safely at ambient temperatures above 70°C. The Absolute Maximum power dissipation for SOT23-5 can be increased by 4.5 mW for each degree below 70°C, and it must be derated by 4.5mW for each degree above 70°C.
- (6) The human body model is 100pF discharged through 1.5kΩ resistor into each pin. The machine model is a 200 pF capacitor discharged directly into each pin.

OPERATING RATINGS⁽¹⁾⁽²⁾

V_{IN}		2.5 to 6V
V_{EN}		0 to $(V_{IN}+0.3V) \leq 6V$
Junction Temperature		-40°C to +125°C
Thermal Resistance	θ_{JA} (SOT23-5)	220°C/W
	θ_{JA} (DSBGA)	340°C/W
Maximum Power Dissipation ⁽³⁾	SOT-23-5	250mW
	DSBGA	160mW

- (1) Stresses beyond those listed under absolute maximum ratings may cause permanent damage to the device. These are stress ratings only, and functional operation of the device at these or any other conditions beyond those indicated under recommended operating conditions is not implied. Exposure to absolute-maximum-rated conditions for extended periods may affect device reliability.
- (2) All voltages are with respect to the potential at the GND pin.
- (3) Like the Absolute Maximum power dissipation, the maximum power dissipation for operation depends on the ambient temperature. The 250mW rating for SOT23-5 appearing under Operating Ratings results from substituting the maximum junction temperature for operation, 125°C, for T_J , 70°C for T_A , and 220°C/W for θ_{JA} using the formula: $P_D = (T_J - T_A)/\theta_{JA}$. More power can be dissipated at ambient temperatures below 70°C. Less power can be dissipated at ambient temperatures above 70°C. The maximum power dissipation for operation can be increased by 4.5 mW for each degree below 70°C, and it must be derated by 4.5mW for each degree above 70°C.

ELECTRICAL CHARACTERISTICS

Unless otherwise specified: $V_{IN} = 2.5V$ for 1.5V and 1.8V options, $V_{IN} = V_{OUT} + 0.5$ for output options higher than 2.5V, $C_{IN} = 1 \mu F$, $I_{OUT} = 1mA$, $C_{OUT} = 1 \mu F$, tantalum. Typical values and limits appearing in standard typeface are for $T_J = 25^\circ C$. Limits appearing in **boldface type** apply over the entire junction temperature range for operation, $-40^\circ C$ to $+125^\circ C$. ⁽¹⁾ ⁽²⁾

Symbol	Parameter	Conditions	Typ	Limit		Units
				Min	Max	
ΔV_{OUT}	Output Voltage Tolerance			-1.2 -2.0	1.2 2.0	% of $V_{OUT(nom)}$
	Line Regulation Error	$V_{IN} = 2.5V$ to 4.5V for 1.5V and 1.8V options $V_{IN} = (V_{OUT} + 0.5V)$ to 4.5V for Voltage options higher than 2.5V	0.05	-0.15	0.15	%/V
	Load Regulation Error ⁽³⁾	$I_{OUT} = 1 mA$ to 150 mA LP3984IM5 (SOT-23-5) LP3984IBP (DSBGA)	0.002 0.0009		0.005 0.002	%/mA
PSRR	Power Supply Rejection Ratio	$V_{IN} = V_{OUT(nom)} + 0.2V$, $f = 1 kHz$, $I_{OUT} = 50 mA$, Figure 4	60			dB
		$V_{IN} = V_{OUT(nom)} + 0.2V$, $f = 10 kHz$, $I_{OUT} = 50 mA$, Figure 4	40			
I_Q	Quiescent Current	$V_{EN} = 1.4V$, $I_{OUT} = 0 mA$	80		125	μA
		$V_{EN} = 1.4V$, $I_{OUT} = 0$ to 150 mA	110		150	
		$V_{EN} = 0.4V$	0.005		1.2	
	Dropout Voltage ⁽⁴⁾	$I_{OUT} = 1 mA$	0.6		2.5	mV
		$I_{OUT} = 50 mA$	25		40	
		$I_{OUT} = 100 mA$	50		80	
		$I_{OUT} = 150 mA$	75		120	
I_{SC}	Short Circuit Current Limit	Output Grounded (Steady State)	600			mA
$I_{OUT(PK)}$	Peak Output Current	$V_{OUT} \geq V_{OUT(nom)} - 5\%$	600	300		mA
T_{ON}	Turn-On Time ⁽⁵⁾		20			μs
e_n	Output Noise Voltage	BW = 10 Hz to 100 kHz, $C_{OUT} = 1\mu F$ tant.	90			μV_{rms}
I_{EN}	Maximum Input Current at EN	$V_{EN} = 0.4$ and $V_{IN} = 6.0$	± 1			nA
V_{IL}	Maximum Low Level Input Voltage at EN	$V_{IN} = 2.5$ to 6.0V			0.4	V
V_{IH}	Minimum High Level Input Voltage at EN	$V_{IN} = 2.5$ to 6.0V		1.4		V
C_{OUT}	Output Capacitor	Capacitance		1	22	μF
		ESR		2	10	Ω
TSD	Thermal Shutdown Temperature		160			$^\circ C$
	Thermal Shutdown Hysteresis		20			$^\circ C$

- (1) Min and Max Limits are verified by design, test, or statistical analysis. Typical (Typ.) numbers are not verified, but do represent the most likely norm.
- (2) The target output voltage, which is labeled $V_{OUT(nom)}$, is the desired voltage option.
- (3) An increase in the load current results in a slight decrease in the output voltage and vice versa.
- (4) Dropout voltage is the input-to-output voltage difference at which the output voltage is 100 mV below its nominal value. This specification does not apply for input voltages below 2.5V.
- (5) Turn-on time is time measured between the enable input just exceeding V_{IH} and the output voltage just reaching 95% of its nominal value.

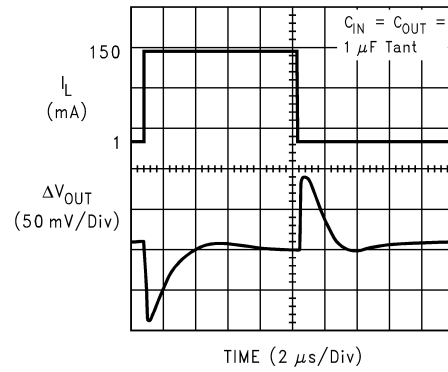

Figure 3. Line Transient Input Test Signal

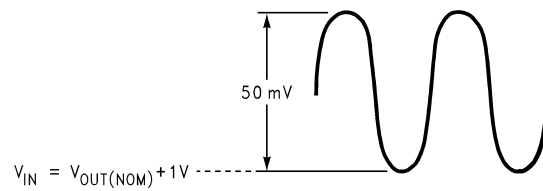

Figure 4. PSRR Input Test Signal

TYPICAL PERFORMANCE CHARACTERISTICS

Unless otherwise specified, $C_{IN} = C_{OUT} = 1 \mu\text{F}$ Tantalum, $V_{IN} = 2.5$ for 1.5V and 1.8V options, $V_{IN} = V_{OUT} + 0.2\text{V}$ for output options higher than 2.5V, $T_A = 25^\circ\text{C}$, Enable pin is tied to V_{IN} .

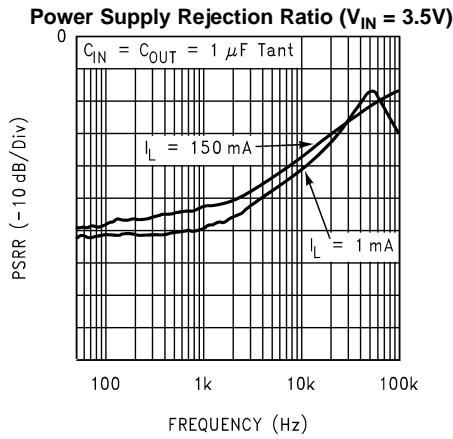

Figure 5.

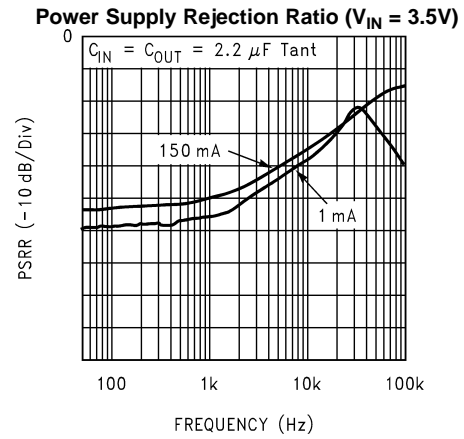

Figure 6.

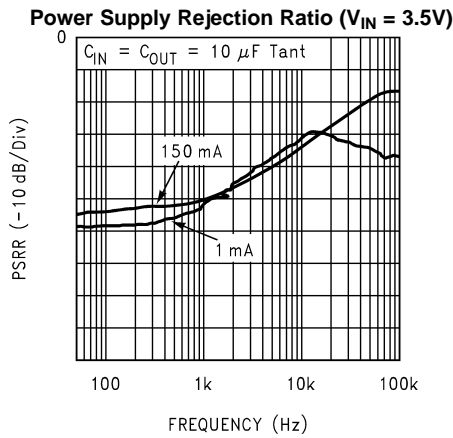

Figure 7.

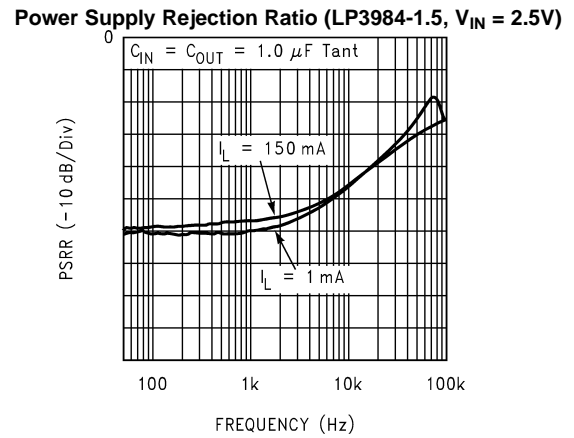

Figure 8.

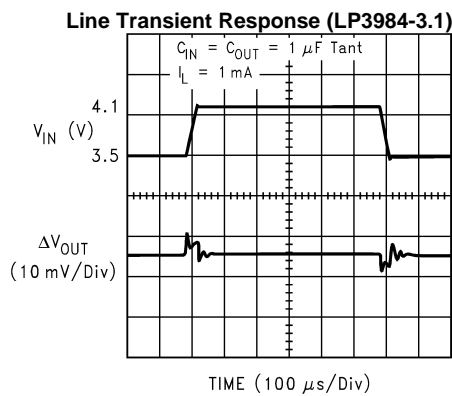

Figure 9.

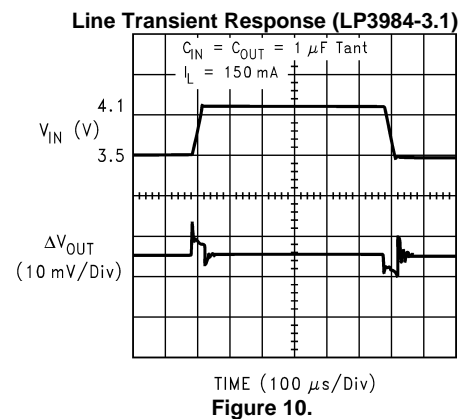

Figure 10.

TYPICAL PERFORMANCE CHARACTERISTICS (continued)

Unless otherwise specified, $C_{IN} = C_{OUT} = 1 \mu\text{F}$ Tantalum, $V_{IN} = 2.5$ for 1.5V and 1.8V options, $V_{IN} = V_{OUT} + 0.2\text{V}$ for output options higher than 2.5V, $T_A = 25^\circ\text{C}$, Enable pin is tied to V_{IN} .

Line Transient Response (LP3984-3.1)

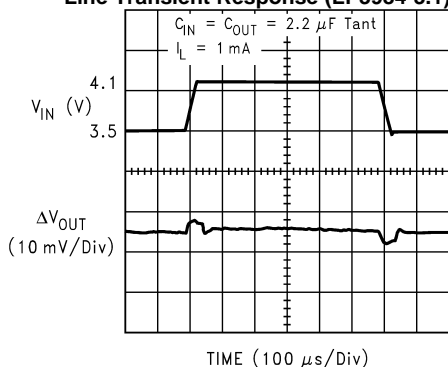

Figure 11.

Line Transient Response (LP3984-3.1)

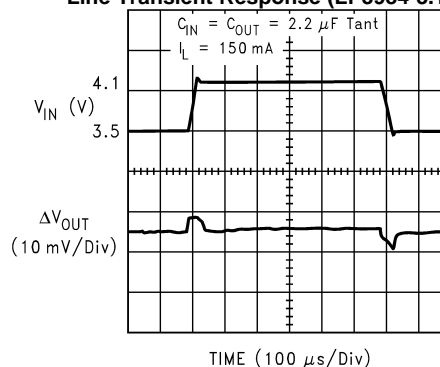

Figure 12.

Line Transient Response (LP3984-3.1)

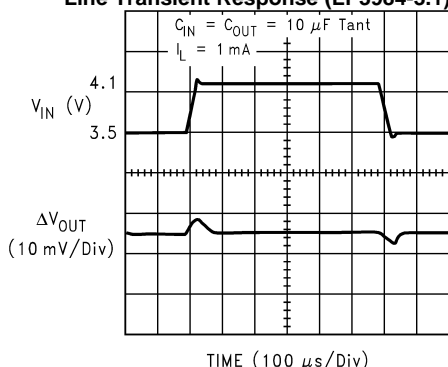

Figure 13.

Line Transient Response (LP3984-3.1)

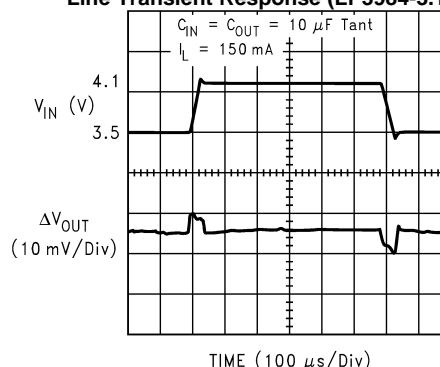

Figure 14.

Start Up Response

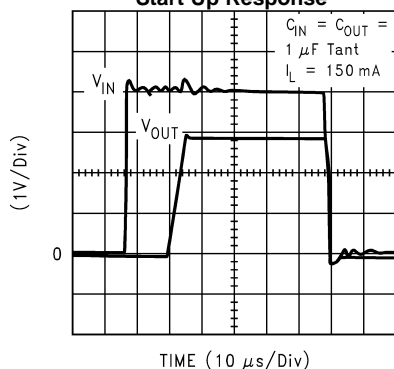

Figure 15.

Start Up Response

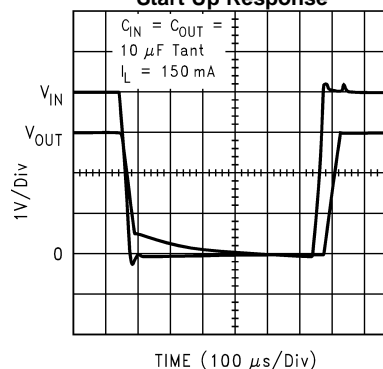
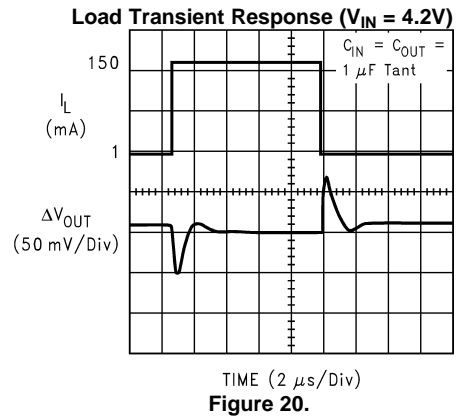
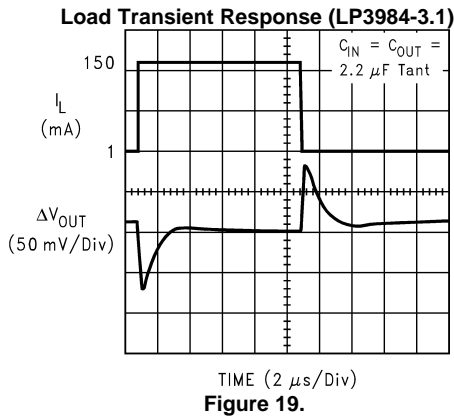
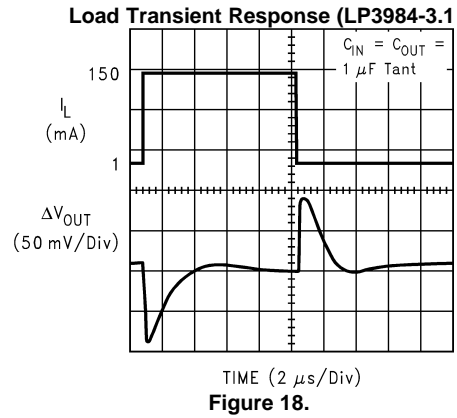
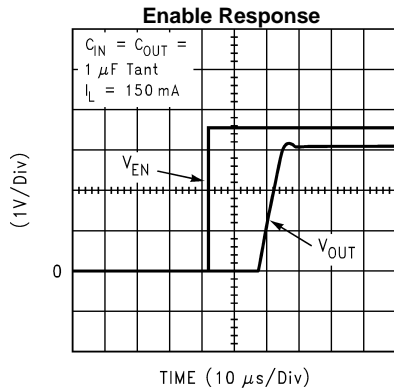

Figure 16.

TYPICAL PERFORMANCE CHARACTERISTICS (continued)

Unless otherwise specified, $C_{IN} = C_{OUT} = 1 \mu\text{F}$ Tantalum, $V_{IN} = 2.5$ for 1.5V and 1.8V options, $V_{IN} = V_{OUT} + 0.2\text{V}$ for output options higher than 2.5V, $T_A = 25^\circ\text{C}$, Enable pin is tied to V_{IN} .



APPLICATION HINTS

External Capacitors

Like any low-dropout regulator, the LP3984 requires external capacitors for regulator stability. The LP3984 is specifically designed for portable applications requiring minimum board space and smallest components. These capacitors must be correctly selected for good performance.

Input Capacitors

An input capacitance of $\cong 1 \mu\text{F}$ is required between the LP3984 input pin and ground (the amount of the capacitance may be increased without limit).

This capacitor must be located a distance of not more than 1 cm from the input pin and returned to a clean analog ground. Any good quality ceramic, tantalum, or film capacitor may be used at the input.

Important: Tantalum capacitors can suffer catastrophic failures due to surge current when connected to a low-impedance source of power (like a battery or a very large capacitor). If a tantalum capacitor is used at the input, it must be specified by the manufacturer to have a surge current rating sufficient for the application.

There are no requirements for the ESR on the input capacitor, but tolerance and temperature coefficient must be considered when selecting the capacitor to ensure the capacitance will be $\cong 1 \mu\text{F}$ over the entire operating temperature range.

Output Capacitor

The LP3984 is designed specifically to work with tantalum output capacitors. A tantalum capacitor in 1 to 22 μF range with 2 Ω to 10 Ω ESR range is suitable in the LP3984 application circuit.

It may also be possible to use film capacitors at the output, but these are not as attractive for reasons of size and cost.

The output capacitor must meet the requirement for minimum amount of capacitance and also have an ESR (Equivalent Series Resistance) value which is within a stable range (2 Ω to 10 Ω).

No-Load Stability

The LP3984 will remain stable and in regulation with no external load. This is specially important in CMOS RAM keep-alive applications.

On/Off Input Operation

The LP3984 is turned off by pulling the V_{EN} pin low, and turned on by pulling it high. If this feature is not used, the V_{EN} pin should be tied to V_{IN} to keep the regulator output on at all times. To assure proper operation, the signal source used to drive the V_{EN} input must be able to swing above and below the specified turn-on/off voltage thresholds listed in the Electrical Characteristics section under V_{IL} and V_{IH} .

Fast On-Time

The LP3984 output is turned on after V_{ref} voltage reaches its final value (1.23V nominal). To speed up this process, the noise reduction capacitor at the bypass pin is charged with an internal 70 μA current source. The current source is turned off when the bandgap voltage reaches approximately 95% of its final value. The turn-on time is determined by the time constant of the bypass capacitor. The smaller the capacitor value, the shorter the turn-on time, but less noise gets reduced. As a result, turn-on time and noise reduction need to be taken into design consideration when choosing the value of the bypass capacitor.

DSBGA Mounting

The DSBGA package requires specific mounting techniques which are detailed in the AN-1112 Application Report ([SNVA009](#)). Referring to the section *PCB Layout*; note that the pad style which must be used with the 5-pin package is NSMD (non-solder mask defined) type.

For best results during assembly, alignment ordinals on the PC board may be used to facilitate placement of the DSBGA device.

DSBGA Light Sensitivity

Exposing the DSBGA device to direct sunlight will cause mis-operation of the device. Light sources such as halogen lamps can affect electrical performance if brought near to the device.

The wavelengths which have most detrimental effect are reds and infra-reds, which means that the fluorescent lighting used inside most buildings has very little effect on performance. A DSBGA test board was brought to within 1 cm of a fluorescent desk lamp and the effect on the regulated output voltage was negligible, showing a deviation of less than 0.1% from nominal.

REVISION HISTORY**Changes from Revision D (May 2013) to Revision E** **Page**

- Changed layout of National Data Sheet to TI format; correct typos [10](#)
-

Changes from Revision E (May 2013) to Revision F **Page**

- Deleted 2.0V option which is obsoleted [1](#)
 - Deleted legacy ordering table [3](#)
-

PACKAGING INFORMATION

Orderable Device	Status (1)	Package Type	Package Drawing	Pins	Package Qty	Eco Plan (2)	Lead/Ball Finish (6)	MSL Peak Temp (3)	Op Temp (°C)	Device Marking (4/5)	Samples
LP3984IMF-1.5	LIFEBUY	SOT-23	DBV	5		TBD	Call TI	Call TI		LEAB	
LP3984IMF-1.5/NOPB	LIFEBUY	SOT-23	DBV	5		TBD	Call TI	Call TI		LEAB	
LP3984IMF-1.8	LIFEBUY	SOT-23	DBV	5		TBD	Call TI	Call TI		LEBB	
LP3984IMF-3.1/NOPB	LIFEBUY	SOT-23	DBV	5		TBD	Call TI	Call TI	-40 to 125	LEDB	
LP3984IMFX-1.8/NOPB	LIFEBUY	SOT-23	DBV	5		TBD	Call TI	Call TI	-40 to 125	LEBB	
LP3984ITP-2.9/NOPB	LIFEBUY	DSBGA	YPB	4		TBD	Call TI	Call TI	-40 to 125		
LP3984ITPX-1.8/NOPB	LIFEBUY	DSBGA	YPB	4		TBD	Call TI	Call TI	-40 to 125		

(1) The marketing status values are defined as follows:

ACTIVE: Product device recommended for new designs.

LIFEBUY: TI has announced that the device will be discontinued, and a lifetime-buy period is in effect.

NRND: Not recommended for new designs. Device is in production to support existing customers, but TI does not recommend using this part in a new design.

PREVIEW: Device has been announced but is not in production. Samples may or may not be available.

OBSOLETE: TI has discontinued the production of the device.

(2) **RoHS:** TI defines "RoHS" to mean semiconductor products that are compliant with the current EU RoHS requirements for all 10 RoHS substances, including the requirement that RoHS substance do not exceed 0.1% by weight in homogeneous materials. Where designed to be soldered at high temperatures, "RoHS" products are suitable for use in specified lead-free processes. TI may reference these types of products as "Pb-Free".

RoHS Exempt: TI defines "RoHS Exempt" to mean products that contain lead but are compliant with EU RoHS pursuant to a specific EU RoHS exemption.

Green: TI defines "Green" to mean the content of Chlorine (Cl) and Bromine (Br) based flame retardants meet JS709B low halogen requirements of <=1000ppm threshold. Antimony trioxide based flame retardants must also meet the <=1000ppm threshold requirement.

(3) MSL, Peak Temp. - The Moisture Sensitivity Level rating according to the JEDEC industry standard classifications, and peak solder temperature.

(4) There may be additional marking, which relates to the logo, the lot trace code information, or the environmental category on the device.

(5) Multiple Device Markings will be inside parentheses. Only one Device Marking contained in parentheses and separated by a "-" will appear on a device. If a line is indented then it is a continuation of the previous line and the two combined represent the entire Device Marking for that device.

(6) Lead/Ball Finish - Orderable Devices may have multiple material finish options. Finish options are separated by a vertical ruled line. Lead/Ball Finish values may wrap to two lines if the finish value exceeds the maximum column width.

Important Information and Disclaimer: The information provided on this page represents TI's knowledge and belief as of the date that it is provided. TI bases its knowledge and belief on information provided by third parties, and makes no representation or warranty as to the accuracy of such information. Efforts are underway to better integrate information from third parties. TI has taken and

continues to take reasonable steps to provide representative and accurate information but may not have conducted destructive testing or chemical analysis on incoming materials and chemicals. TI and TI suppliers consider certain information to be proprietary, and thus CAS numbers and other limited information may not be available for release.

In no event shall TI's liability arising out of such information exceed the total purchase price of the TI part(s) at issue in this document sold by TI to Customer on an annual basis.

GENERIC PACKAGE VIEW

DBV 5

SOT-23 - 1.45 mm max height

SMALL OUTLINE TRANSISTOR



Images above are just a representation of the package family, actual package may vary.
Refer to the product data sheet for package details.

4073253/P



YPB0004

PACKAGE OUTLINE

DSBGA - 0.575 mm max height

DIE SIZE BALL GRID ARRAY

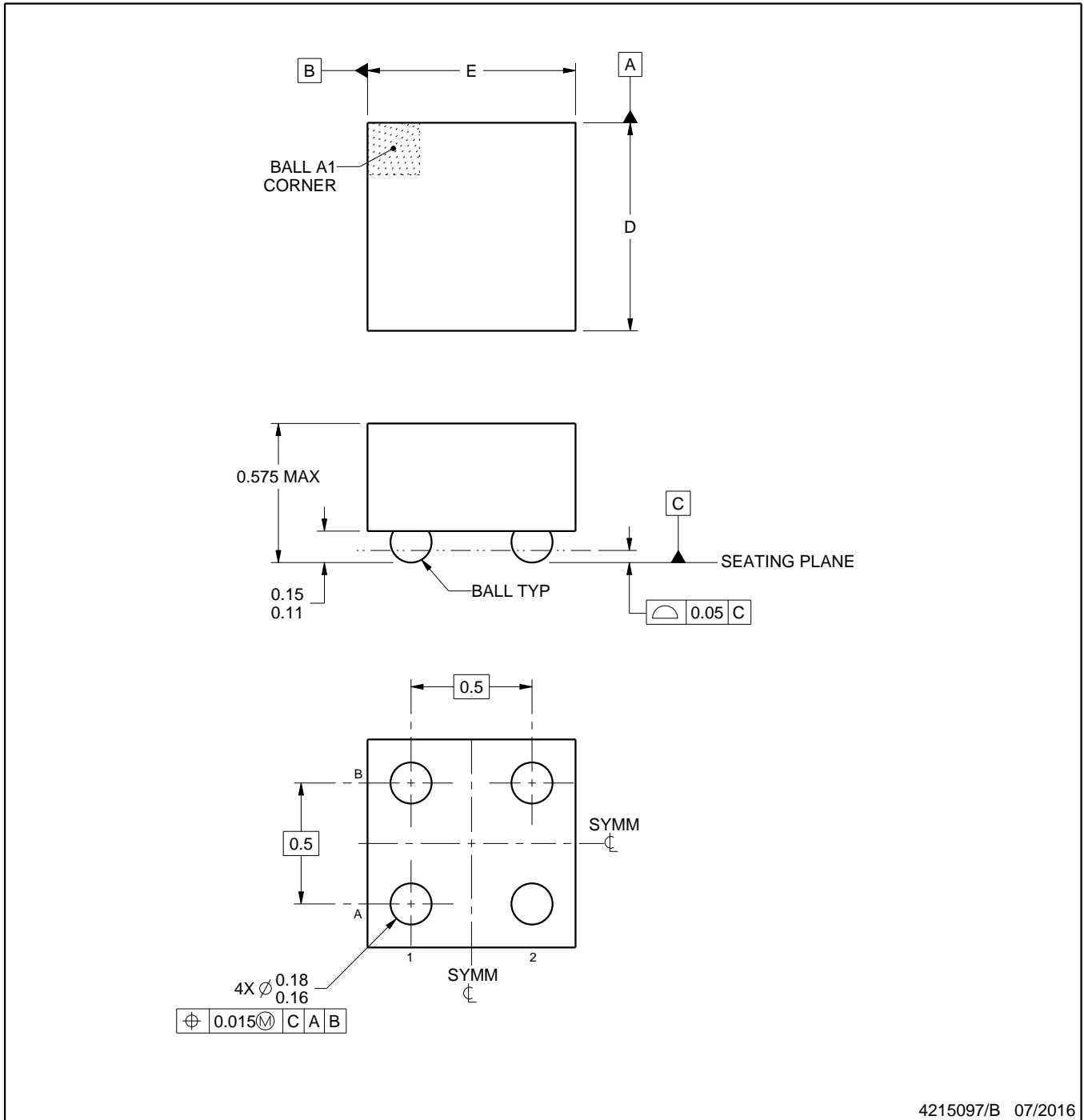

4215097/B 07/2016

NOTES:

1. All linear dimensions are in millimeters. Any dimensions in parenthesis are for reference only. Dimensioning and tolerancing per ASME Y14.5M.
2. This drawing is subject to change without notice.

EXAMPLE BOARD LAYOUT

YPB0004

DSBGA - 0.575 mm max height

DIE SIZE BALL GRID ARRAY

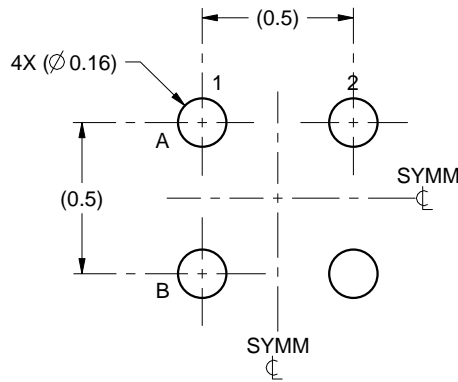

LAND PATTERN EXAMPLE
SCALE:40X

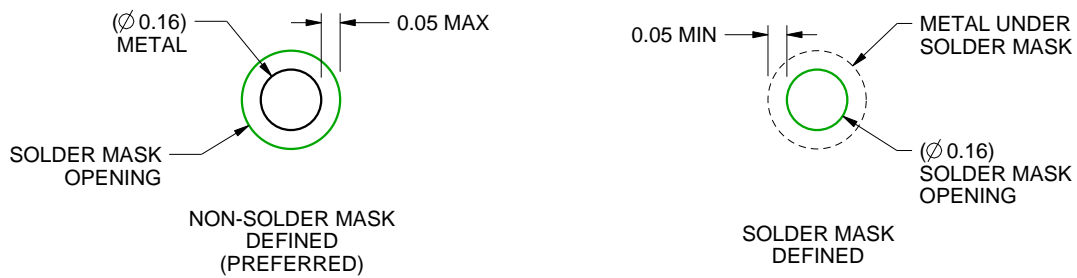

SOLDER MASK DETAILS
NOT TO SCALE

4215097/B 07/2016

NOTES: (continued)

- Final dimensions may vary due to manufacturing tolerance considerations and also routing constraints. See Texas Instruments Literature No. SNVA009 (www.ti.com/lit/snva009).

EXAMPLE STENCIL DESIGN

YPB0004

DSBGA - 0.575 mm max height

DIE SIZE BALL GRID ARRAY

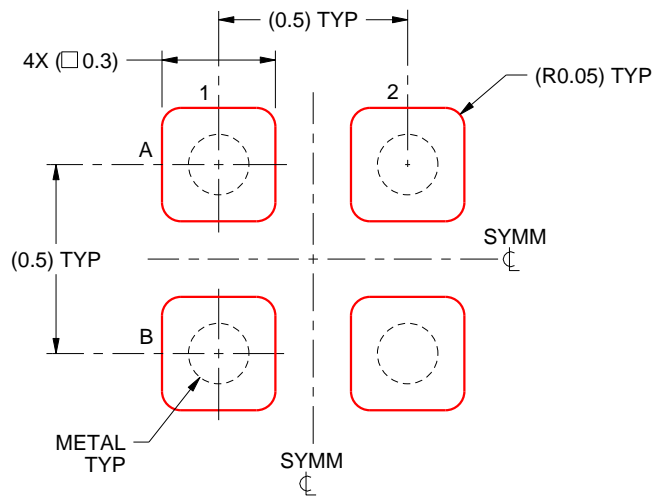

SOLDER PASTE EXAMPLE
BASED ON 0.125mm THICK STENCIL
SCALE:50X

4215097/B 07/2016

NOTES: (continued)

4. Laser cutting apertures with trapezoidal walls and rounded corners may offer better paste release.

IMPORTANT NOTICE

Texas Instruments Incorporated (TI) reserves the right to make corrections, enhancements, improvements and other changes to its semiconductor products and services per JESD46, latest issue, and to discontinue any product or service per JESD48, latest issue. Buyers should obtain the latest relevant information before placing orders and should verify that such information is current and complete.

TI's published terms of sale for semiconductor products (<http://www.ti.com/sc/docs/stdterms.htm>) apply to the sale of packaged integrated circuit products that TI has qualified and released to market. Additional terms may apply to the use or sale of other types of TI products and services.

Reproduction of significant portions of TI information in TI data sheets is permissible only if reproduction is without alteration and is accompanied by all associated warranties, conditions, limitations, and notices. TI is not responsible or liable for such reproduced documentation. Information of third parties may be subject to additional restrictions. Resale of TI products or services with statements different from or beyond the parameters stated by TI for that product or service voids all express and any implied warranties for the associated TI product or service and is an unfair and deceptive business practice. TI is not responsible or liable for any such statements.

Buyers and others who are developing systems that incorporate TI products (collectively, "Designers") understand and agree that Designers remain responsible for using their independent analysis, evaluation and judgment in designing their applications and that Designers have full and exclusive responsibility to assure the safety of Designers' applications and compliance of their applications (and of all TI products used in or for Designers' applications) with all applicable regulations, laws and other applicable requirements. Designer represents that, with respect to their applications, Designer has all the necessary expertise to create and implement safeguards that (1) anticipate dangerous consequences of failures, (2) monitor failures and their consequences, and (3) lessen the likelihood of failures that might cause harm and take appropriate actions. Designer agrees that prior to using or distributing any applications that include TI products, Designer will thoroughly test such applications and the functionality of such TI products as used in such applications.

TI's provision of technical, application or other design advice, quality characterization, reliability data or other services or information, including, but not limited to, reference designs and materials relating to evaluation modules, (collectively, "TI Resources") are intended to assist designers who are developing applications that incorporate TI products; by downloading, accessing or using TI Resources in any way, Designer (individually or, if Designer is acting on behalf of a company, Designer's company) agrees to use any particular TI Resource solely for this purpose and subject to the terms of this Notice.

TI's provision of TI Resources does not expand or otherwise alter TI's applicable published warranties or warranty disclaimers for TI products, and no additional obligations or liabilities arise from TI providing such TI Resources. TI reserves the right to make corrections, enhancements, improvements and other changes to its TI Resources. TI has not conducted any testing other than that specifically described in the published documentation for a particular TI Resource.

Designer is authorized to use, copy and modify any individual TI Resource only in connection with the development of applications that include the TI product(s) identified in such TI Resource. NO OTHER LICENSE, EXPRESS OR IMPLIED, BY ESTOPPEL OR OTHERWISE TO ANY OTHER TI INTELLECTUAL PROPERTY RIGHT, AND NO LICENSE TO ANY TECHNOLOGY OR INTELLECTUAL PROPERTY RIGHT OF TI OR ANY THIRD PARTY IS GRANTED HEREIN, including but not limited to any patent right, copyright, mask work right, or other intellectual property right relating to any combination, machine, or process in which TI products or services are used. Information regarding or referencing third-party products or services does not constitute a license to use such products or services, or a warranty or endorsement thereof. Use of TI Resources may require a license from a third party under the patents or other intellectual property of the third party, or a license from TI under the patents or other intellectual property of TI.

TI RESOURCES ARE PROVIDED "AS IS" AND WITH ALL FAULTS. TI DISCLAIMS ALL OTHER WARRANTIES OR REPRESENTATIONS, EXPRESS OR IMPLIED, REGARDING RESOURCES OR USE THEREOF, INCLUDING BUT NOT LIMITED TO ACCURACY OR COMPLETENESS, TITLE, ANY EPIDEMIC FAILURE WARRANTY AND ANY IMPLIED WARRANTIES OF MERCHANTABILITY, FITNESS FOR A PARTICULAR PURPOSE, AND NON-INFRINGEMENT OF ANY THIRD PARTY INTELLECTUAL PROPERTY RIGHTS. TI SHALL NOT BE LIABLE FOR AND SHALL NOT DEFEND OR INDEMNIFY DESIGNER AGAINST ANY CLAIM, INCLUDING BUT NOT LIMITED TO ANY INFRINGEMENT CLAIM THAT RELATES TO OR IS BASED ON ANY COMBINATION OF PRODUCTS EVEN IF DESCRIBED IN TI RESOURCES OR OTHERWISE. IN NO EVENT SHALL TI BE LIABLE FOR ANY ACTUAL, DIRECT, SPECIAL, COLLATERAL, INDIRECT, PUNITIVE, INCIDENTAL, CONSEQUENTIAL OR EXEMPLARY DAMAGES IN CONNECTION WITH OR ARISING OUT OF TI RESOURCES OR USE THEREOF, AND REGARDLESS OF WHETHER TI HAS BEEN ADVISED OF THE POSSIBILITY OF SUCH DAMAGES.

Unless TI has explicitly designated an individual product as meeting the requirements of a particular industry standard (e.g., ISO/TS 16949 and ISO 26262), TI is not responsible for any failure to meet such industry standard requirements.

Where TI specifically promotes products as facilitating functional safety or as compliant with industry functional safety standards, such products are intended to help enable customers to design and create their own applications that meet applicable functional safety standards and requirements. Using products in an application does not by itself establish any safety features in the application. Designers must ensure compliance with safety-related requirements and standards applicable to their applications. Designer may not use any TI products in life-critical medical equipment unless authorized officers of the parties have executed a special contract specifically governing such use. Life-critical medical equipment is medical equipment where failure of such equipment would cause serious bodily injury or death (e.g., life support, pacemakers, defibrillators, heart pumps, neurostimulators, and implantables). Such equipment includes, without limitation, all medical devices identified by the U.S. Food and Drug Administration as Class III devices and equivalent classifications outside the U.S.

TI may expressly designate certain products as completing a particular qualification (e.g., Q100, Military Grade, or Enhanced Product). Designers agree that it has the necessary expertise to select the product with the appropriate qualification designation for their applications and that proper product selection is at Designers' own risk. Designers are solely responsible for compliance with all legal and regulatory requirements in connection with such selection.

Designer will fully indemnify TI and its representatives against any damages, costs, losses, and/or liabilities arising out of Designer's non-compliance with the terms and provisions of this Notice.

Mouser Electronics

Authorized Distributor

Click to View Pricing, Inventory, Delivery & Lifecycle Information:

Texas Instruments:

[LP3984IMF-1.5](#) [LP3984IMF-1.5/NOPB](#) [LP3984IMF-1.8](#) [LP3984IMF-1.8/NOPB](#) [LP3984IMF-3.1](#) [LP3984IMF-3.1/NOPB](#) [LP3984IMFX-1.8](#) [LP3984IMFX-1.8/NOPB](#) [LP3984ITP-2.9/NOPB](#) [LP3984ITP-3.1/NOPB](#) [LP3984ITPX-1.8/NOPB](#) [LP3984ITPX-3.1/NOPB](#)