

Filter Inductors

Toroid



FEATURES

- Choice of encapsulated (TE) or dipped (TD) styles.
- TD style combines low cost with excellent performance in commercial applications.
- High Q and wide selection of Q versus frequency ranges in one small package. Large number of standard inductance values.

STANDARD ELECTRICAL SPECIFICATIONS (Applies to Core Only)

MODEL			TC CODE	TEMPERATURE COEFFICIENT	TEMPERATURE RANGE	TC AVAILABILITY		
TE-3 TD-3	TE-4 TD-4	TE-5 TD-5				Q0	Q3	Q4
X	X	X	TA	0 ± 1%	- 55°C to + 125°C		X	X
X	X	X	TD	0 ± 0.1%	0°C to + 55°C		X	X
X	X	X	TL*	+ 40 to + 110PPM/°C + 85 to + 185PPM/°C	- 55°C to + 25°C + 25°C to + 85°C			X
X	X	X	TM	0 ± 0.25%	- 65°C to + 125°C		X	X
X	X	X	TR	50PPM/°C (Typical)	- 65°C to + 125°C	X		
X	X	X	TW	0 ± 0.25%	- 55°C to + 85°C		X	X

*Inverse of typical Temperature Coefficient of polystyrene capacitor.

INDUCTANCE RANGES

TC CODE	TE-3 TD-3	TE-4 TD-4	TE-5 TD-5
Q0	50µH to 15mH	150µH to 20mH	1mH to 100mH
Q3	500µH to 1H	1mH to 2H	5mH to 2H
Q4	1mH to 4H	2mH to 5H	10mH to 5H

ELECTRICAL SPECIFICATIONS

Tolerance:

TE-3, TD-3 = ± 1% > 2mH, ± 2% 154µH to 2mH, ± 5% < 150µH.
TE-4, TD-4 = ± 1% > 2mH, ± 2% < 2mH.
TE-5, TD-5 = ± 1% > 2mH, ± 2% < 2mH.

Insulation Resistance: 1000 Megohm minimum.

Dielectric Strength: 1000V minimum (TE).
500V minimum (TD).

MECHANICAL SPECIFICATIONS

Terminal Strength: 2 pounds pull test (TE).

Vibration: Per MIL-T-27 (TE).

Shock: Per MIL-T-27 (TE).

Weight:

TE-3 = 5.1 grams, TD-3 = 4.9 grams typical.
TE-4 = 20 grams, TD-4 = 17 grams typical.
TE-5 = 53 grams, TD-5 = 52 grams typical.

MATERIAL SPECIFICATIONS

Coating: Vinyl (TD), non-flammable, abrasion and moisture resistant. Resists most cleaning agents. (Consult factory for chemicals which may be used.)

Standard Terminals: Tinned copper (TE).
Stranded, tinned copper, Teflon insulated (TD).

Encapsulant: Epoxy (TE).

Gauge:

TE-3 = 22 AWG, TD-3 = 26 AWG.
TE-4 = 20 AWG, TD-4 = 24 AWG.
TE-5 = 20 AWG, TD-5 = 24 AWG.

DIMENSIONS in inches [millimeters]

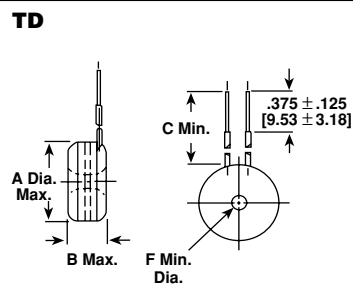
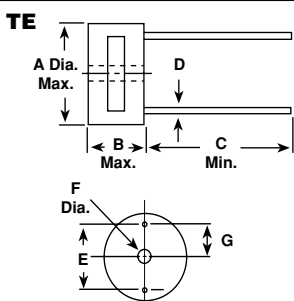

MODEL	A	B	C	D	E	F	G
TE-3	0.685 [17.40]	0.385 [9.78]	1.0 [25.40]	0.025 [0.635]	0.500 [12.70]	0.093 [2.36]	0.250 [6.35]
TD-3	0.685 [17.40]	0.320 [8.13]	3.0 [76.20]	—	—	0.125 [3.18]	—
TE-4	1.06 [26.92]	0.500 [12.70]	1.0 [25.40]	0.032 [0.813]	0.900 [22.86]	0.120 [3.05]	0.450 [11.43]
TD-4	1.06 [26.92]	0.437 [11.10]	4.0 [101.60]	—	—	0.220 [5.59]	—
TE-5	1.32 [33.53]	0.725 [18.42]	1.0 [25.40]	0.032 [0.813]	1.0 [25.40]	0.144 [3.66]	0.500 [12.70]
TD-5	1.32 [33.53]	0.688 [17.48]	6.0 [152.40]	—	—	0.220 [5.59]	—



DC RESISTANCE AND SELF-RESONANT FREQUENCIES (Typical Values)							
MODEL	INDUCTANCE	DCR (Ohms)			SELF-RESONANT FREQUENCY (MHz)		
		Q0	Q3	Q4	Q0	Q3	Q4
TE-3, TD-3	50.0μH	0.68	—	—	7.6	—	—
TE-3, TD-3	100.0μH	1.0	—	—	5.1	—	—
TE-3, TD-3	332.0μH	3.3	—	—	2.9	—	—
TE-3, TD-3	1.0mH	6.9	1.5	0.82	1.4	1.1	1.0
TE-3, TD-3	3.32mH	24.0	4.1	2.3	0.79	0.57	0.55
TE-3, TD-3	10.0mH	84.0	14.0	5.9	0.40	0.29	0.25
TE-3, TD-3	15.0mH	106.0	17.0	9.1	0.34	0.24	0.21
TE-3, TD-3	33.2mH	—	40.0	18.0	—	0.14	0.12
TE-3, TD-3	100.0mH	—	138.0	58.0	—	0.08	0.077
TE-3, TD-3	332.0mH	—	555.0	220.0	—	0.04	0.038
TE-3, TD-3	1.0H	—	1500.0	670.0	—	0.021	0.019
TE-3, TD-3	4.0H	—	—	2700.0	—	—	0.009
TE-4, TD-4	150.0μH	0.54	—	—	2.6	—	—
TE-4, TD-4	1.0mH	2.8	0.7	—	1.0	0.75	—
TE-4, TD-4	2.0mH	5.5	1.4	0.78	0.64	0.54	0.45
TE-4, TD-4	10.0mH	27.0	4.9	2.5	0.24	0.21	0.18
TE-4, TD-4	20.0mH	54.0	9.6	5.0	0.18	0.15	0.13
TE-4, TD-4	100.0mH	—	56.0	23.0	—	0.059	0.051
TE-4, TD-4	1.0H	—	570.0	260.0	—	0.016	0.014
TE-4, TD-4	2.0H	—	1200.0	520.0	—	0.013	0.011
TE-5, TD-5	1.0mH	1.8	—	—	0.80	—	—
TE-5, TD-5	3.32mH	5.2	—	—	0.44	—	—
TE-5, TD-5	5.0mH	6.5	1.8	—	0.33	0.32	—
TE-5, TD-5	10.0mH	13.0	2.4	1.7	0.21	0.20	0.15
TE-5, TD-5	33.2mH	49.0	8.8	3.9	0.12	0.11	0.086
TE-5, TD-5	100.0mH	133.0	27.0	11.0	0.061	0.057	0.044
TE-5, TD-5	332.0mH	—	80.0	44.0	—	0.032	0.024
TE-5, TD-5	1.0H	—	222.0	121.0	—	0.016	0.012
TE-5, TD-5	2.0H	—	475.0	217.0	—	0.012	0.008

STANDARD INDUCTANCE VALUE														
<p>The following standardization chart is offered for your design and ordering convenience. Each value listed is within one percent of the preceding and succeeding values shown. All decade multiples of these values, within the range shown for each model in the chart, are Vishay Dale standard values. (Example: For a TE-3, 200μH, 20mH and 200mH are all decade multiples of 2.00 and are all standard values.)</p>	1.00	1.21	1.47	1.78	2.15	2.61	3.09	3.74	4.42	5.23	6.19	7.32	8.66	
	1.02	1.24	1.50	1.82	2.21	2.67	3.16	3.83	4.53	5.36	6.34	7.50	8.87	
	1.05	1.27	1.54	1.87	2.26	2.74	3.24	3.92	4.64	5.49	6.49	7.68	9.00	
	1.07	1.30	1.58	1.91	2.32	2.80	3.32	4.00	4.75	5.62	6.65	7.87	9.09	
	1.10	1.33	1.62	1.96	2.37	2.87	3.40	4.02	4.87	5.76	6.81	8.00	9.31	
	1.13	1.37	1.65	2.00	2.43	2.94	3.48	4.12	4.99	5.90	6.98	8.06	9.53	
	1.15	1.40	1.69	2.05	2.49	3.00	3.57	4.22	5.00	6.00	7.00	8.25	9.76	
	1.18	1.43	1.74	2.10	2.55	3.01	3.65	4.32	5.11	6.04	7.15	8.45		

PERFORMANCE GRAPHS: INDUCTANCE VS DC BIAS, INDUCTANCE VS AC EXCITATION

TE-3, TD-3

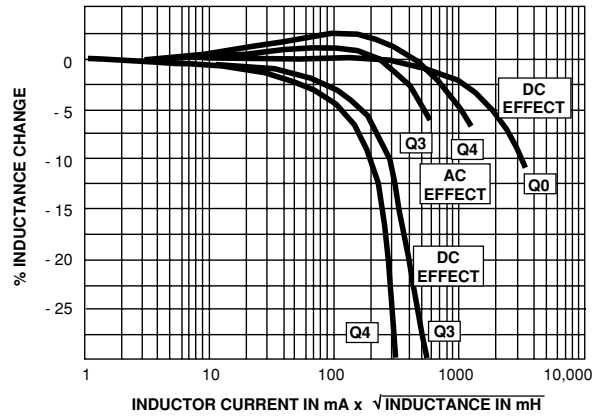

TE-4, TD-4

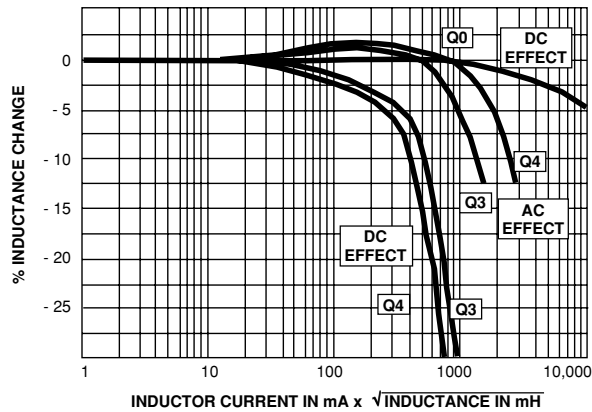

TE-5, TD-5

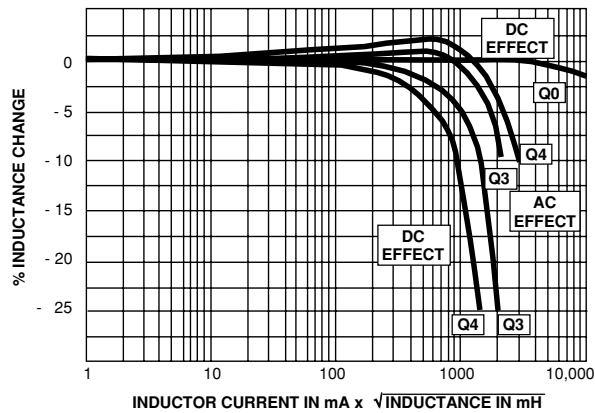



PERFORMANCE GRAPHS: TYPICAL Q VS FREQUENCY

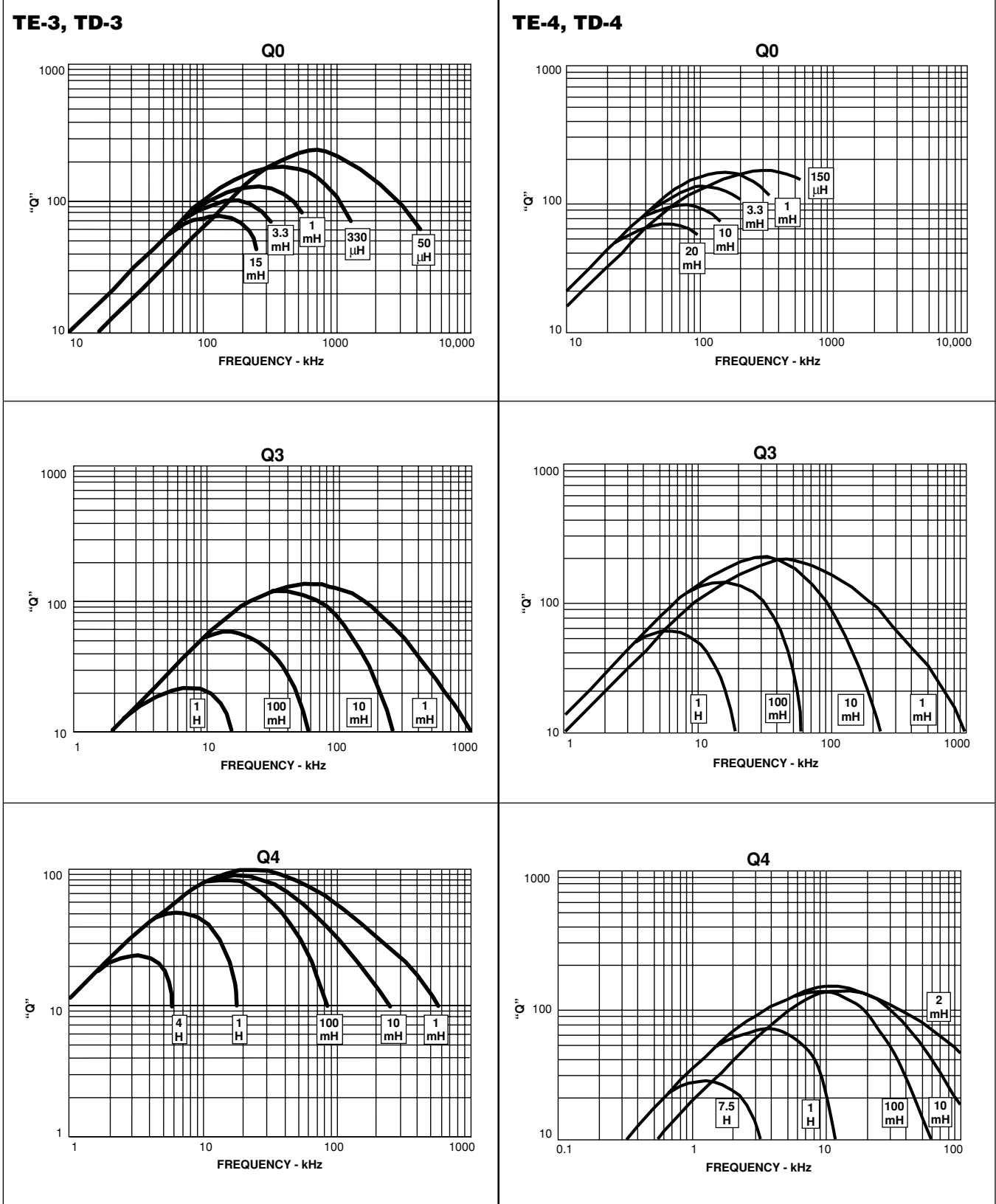



PERFORMANCE GRAPHS: TYPICAL Q VS FREQUENCY

TE-5, TD-5

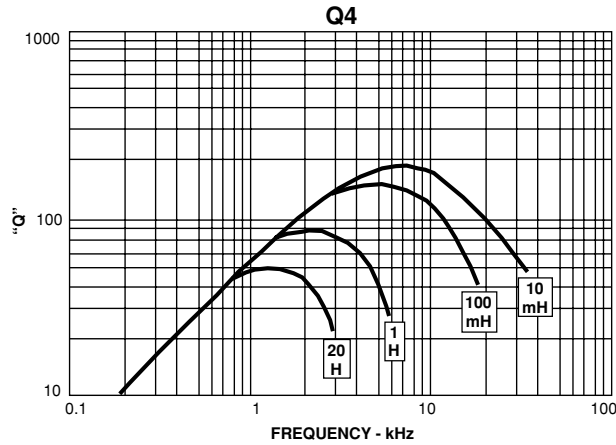
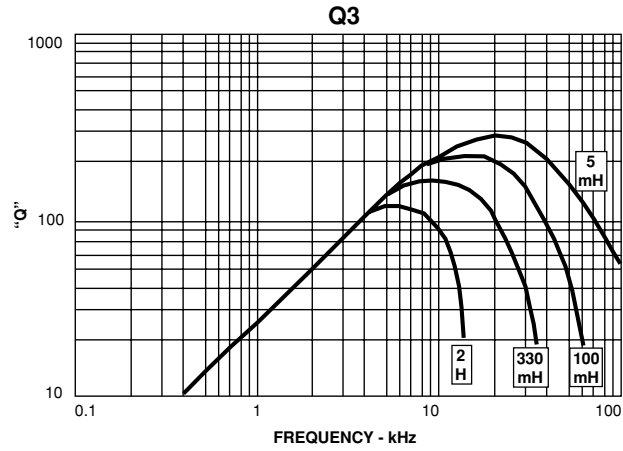
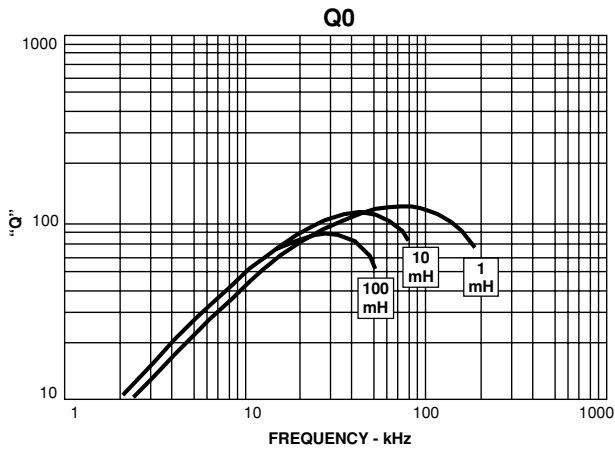

MARKING

- Vishay Dale
- Model
- Q type
- TC code
- Inductance value
- Inductance tolerance
- Date code

ORDERING INFORMATION

TE-3
MODEL

Q0
Q
TYPE

TR
TC CODE

5mH
INDUCTANCE
VALUE

± 1%
INDUCTANCE
TOLERANCE