

Features

- Low Forward Voltage Drop
- Fast Switching
- Ultra-Small Surface Mount Package
- PN Junction Guard Ring for Transient and ESD Protection
- **Lead, Halogen and Antimony Free, RoHS Compliant "Green" Device (Notes 3, 4 and 5)**

Mechanical Data

- Case: SOT-523
- Case Material: Molded Plastic. UL Flammability Classification Rating 94V-0
- Moisture Sensitivity: Level 1 per J-STD-020D
- Terminals: Solderable per MIL-STD-202, Method 208
- Lead Free Plating (Matte Tin Finish annealed over Alloy 42 leadframe).
- Polarity: See Diagrams Below
- Marking Information: See Page 2
- Ordering Information: See Page 2
- Weight: 0.002 grams (approximate)

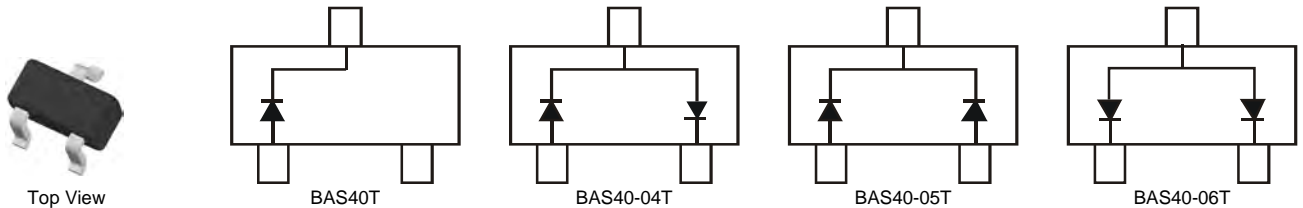

Maximum Ratings @ $T_A = 25^\circ\text{C}$ unless otherwise specified

Characteristic	Symbol	Value	Unit
Peak Repetitive Reverse Voltage	V_{RRM}	40	V
Working Peak Reverse Voltage	V_{RWM}		
DC Blocking Voltage	V_R		
RMS Reverse Voltage	$V_{R(RMS)}$	28	V
Forward Continuous Current (Note 1)	I_{FM}	200	mA
Non-Repetitive Peak Forward Surge Current @ $t = 1.0\text{s}$	I_{FSM}	600	mA

Thermal Characteristics

Characteristic	Symbol	Value	Unit
Power Dissipation (Note 1)	P_D	150	mW
Thermal Resistance Junction to Ambient (Note 1)	$R_{\theta JA}$	833	$^\circ\text{C}/\text{W}$
Operating Temperature Range	T_J	-55 to +125	$^\circ\text{C}$
Storage Temperature Range	T_{STG}	-65 to +150	$^\circ\text{C}$

Electrical Characteristics @ $T_A = 25^\circ\text{C}$ unless otherwise specified

Characteristic	Symbol	Min	Max	Unit	Test Condition
Reverse Breakdown Voltage (Note 2)	$V_{(BR)R}$	40	—	V	$I_R = 10\mu\text{A}$
Forward Voltage	V_F	—	380	mV	$I_F = 1.0\text{mA}$, $t_p < 300\mu\text{s}$
			1000	mV	$I_F = 40\text{mA}$, $t_p < 300\mu\text{s}$
Leakage Current (Note 2)	I_R	—	200	nA	$V_R = 30\text{V}$
Total Capacitance	C_T	—	5.0	pF	$V_R = 0$, $f = 1.0\text{MHz}$
Reverse Recovery Time	t_{rr}	—	5.0	ns	$I_F = I_R = 10\text{mA}$, $I_{rr} = 0.1 \times I_R$, $R_L = 100\Omega$

- Notes:
1. Device mounted on FR-4 PC board with recommended pad layout, which can be found on our website at <http://www.diodes.com/datasheets/ap02001.pdf>.
 2. Short duration pulse test used to minimize self-heating effect.
 3. No purposefully added lead. Halogen and Antimony Free.
 4. Diodes Inc.'s "Green" policy can be found on our website at http://www.diodes.com/products/lead_free/index.php.
 5. Product manufactured with Green Molding Compound and does not contain Halogens or Sb_2O_3 Fire Retardants.

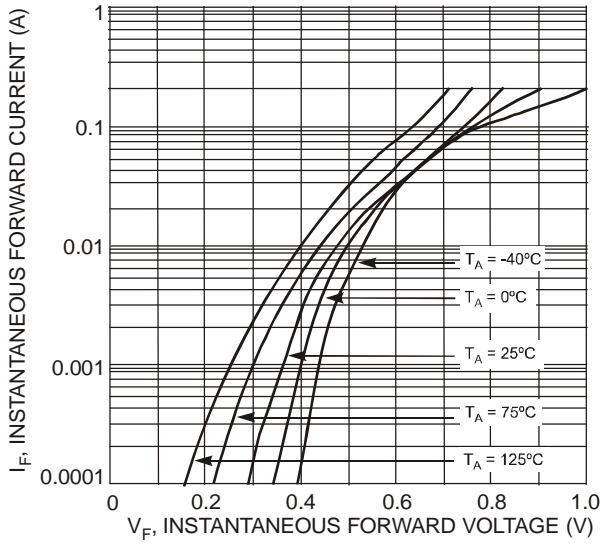

Fig. 1 Typical Forward Characteristics

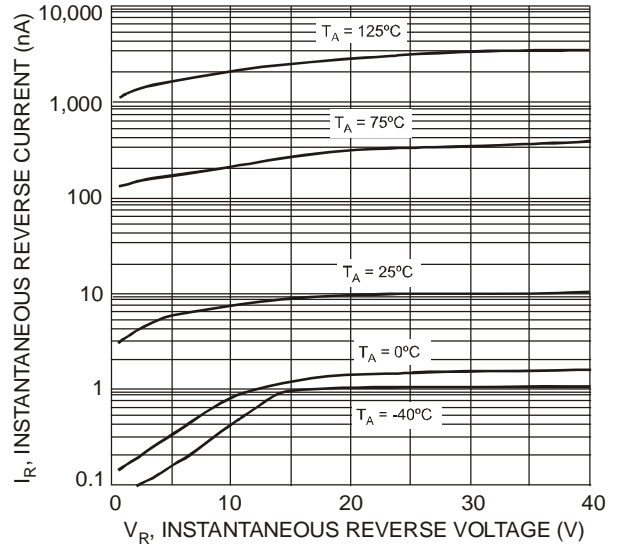

Fig. 2 Typical Reverse Characteristics

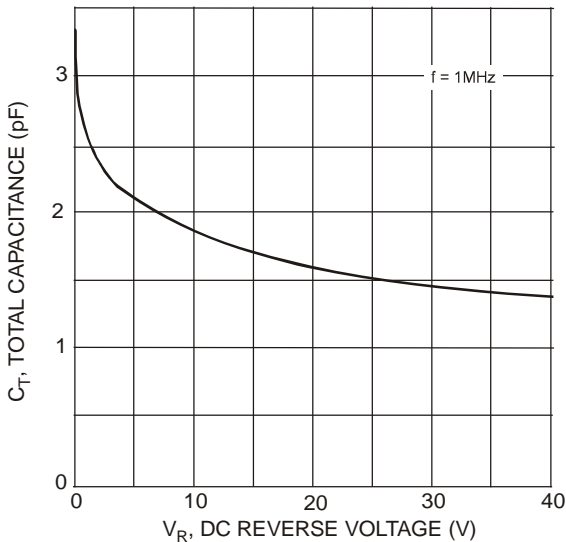

Fig. 3 Total Capacitance vs. Reverse Voltage

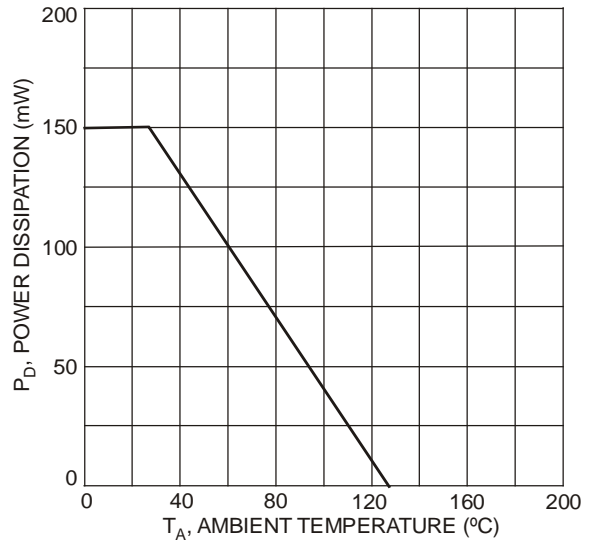

Fig. 4 Power Derating Curve, Total Package

Ordering Information (Note 6)

Part Number	Case	Packaging
BAS40T-7-F	SOT-523	3000/Tape & Reel
BAS40-04T-7-F	SOT-523	3000/Tape & Reel
BAS40-05T-7-F	SOT-523	3000/Tape & Reel
BAS40-06T-7-F	SOT-523	3000/Tape & Reel

Notes: 6. For packaging details, go to our website at <http://www.diodes.com/datasheets/ap02007.pdf>.

Marking Information

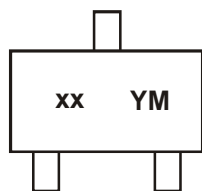

xx = Product Type Marking Code
 43 = BAS40T
 44 = BAS40-04T
 45 = BAS40-05T
 46 = BAS40-06T
 YM = Date Code Marking
 Y = Year (ex: N = 2002)
 M = Month (ex: 9 = September)

Date Code Key

Year	2001	2002	2003	2004	2005	2006	2007	2008	2009	2010	2011	2012	2013	2014	2015
Code	M	N	P	R	S	T	U	V	W	X	Y	Z	A	B	C
Month	Jan	Feb	Mar	Apr	May	Jun	Jul	Aug	Sep	Oct	Nov	Dec			
Code	1	2	3	4	5	6	7	8	9	O	N	D			

Package Outline Dimensions

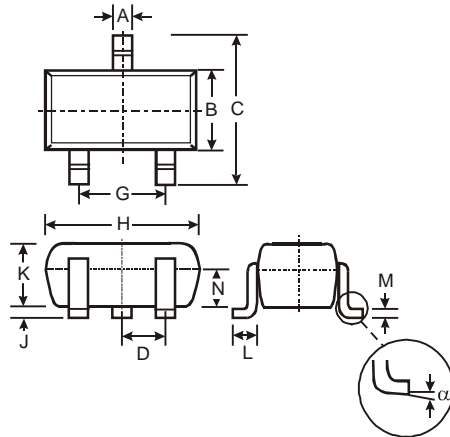

SOT-523			
Dim	Min	Max	Typ
A	0.15	0.30	0.22
B	0.75	0.85	0.80
C	1.45	1.75	1.60
D	—	—	0.50
G	0.90	1.10	1.00
H	1.50	1.70	1.60
J	0.00	0.10	0.05
K	0.60	0.80	0.75
L	0.10	0.30	0.22
M	0.10	0.20	0.12
N	0.45	0.65	0.50
α	0°	8°	—
All Dimensions in mm			

Suggested Pad Layout

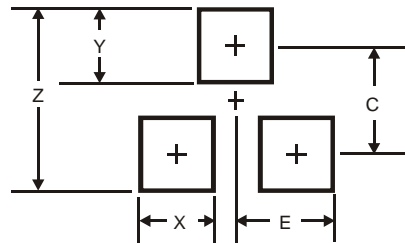

Dimensions	Value (in mm)
Z	1.8
X	0.4
Y	0.51
C	1.3
E	0.7

IMPORTANT NOTICE

Diodes Incorporated and its subsidiaries reserve the right to make modifications, enhancements, improvements, corrections or other changes without further notice to any product herein. Diodes Incorporated does not assume any liability arising out of the application or use of any product described herein; neither does it convey any license under its patent rights, nor the rights of others. The user of products in such applications shall assume all risks of such use and will agree to hold Diodes Incorporated and all the companies whose products are represented on our website, harmless against all damages.

LIFE SUPPORT

Diodes Incorporated products are not authorized for use as critical components in life support devices or systems without the expressed written approval of the President of Diodes Incorporated.