

DS3695A/DS3695AT/DS3696A Multipoint RS485/RS422 Transceivers

 Check for Samples: [DS3695A](#), [DS3695AT](#), [DS3696A](#)

FEATURES

- Meets EIA Standard RS485 for Multipoint Bus Transmission and is Compatible with RS-422
- 10 Ns Driver Propagation Delays (Typical)
- Single +5V Supply
- -7V to +12V Bus Common Mode Range Permits $\pm 7V$ Ground Difference between Devices on the Bus
- Thermal Shutdown Protection
- High Impedance to Bus with Driver in TRI-STATE or with Power Off, over the Entire Common Mode Range Allows the Unused Devices on the Bus to be Powered Down
- Combined Impedance of a Driver Output and Receiver Input is less than One RS485 Unit Load, Allowing up to 32 Transceivers on the Bus
- 70 mV Typical Receiver Hysteresis
- Available in SOIC Packaging

DESCRIPTION

The DS3695A and DS3696A are high speed differential TRI-STATE bus/line transceivers designed to meet the requirements of EIA standard RS485 with extended common mode range (+12V to -7V), for multipoint data transmission. In addition they are compatible with requirements of RS-422.

The driver and receiver outputs feature TRI-STATE capability. The driver outputs remain in over the entire common mode range of +12V to -7V. Bus faults that cause excessive power dissipation within the device trigger a thermal shutdown circuit, which forces the driver outputs into the high impedance state. The DS3696A provides an output pin (TS) which reports the thermal shutdown of the device. TS is an "open collector" pin with an internal 10 k Ω pull-up resistor. This allows the TS outputs of several devices to be wire OR-ed.

Both AC and DC specifications are guaranteed over the 0°C to 70°C temperature and 4.75V to 5.25V supply voltage range.

Connection and Logic Diagrams

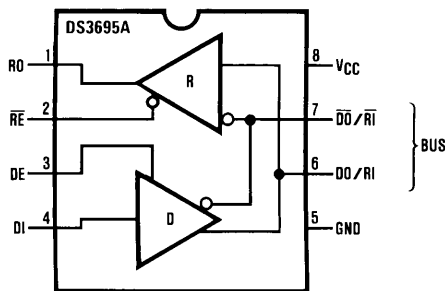

Figure 1. Molded Package, Small Outline (D0008A)
Top View

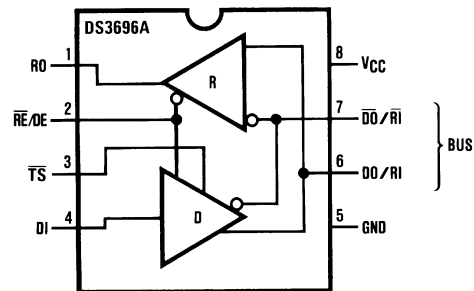

Figure 2. Top View
(See Package Number D0008A)

\overline{TS} was \overline{LF} (Line Fault) on previous datasheets, \overline{TS} goes low upon thermal shutdown.



Please be aware that an important notice concerning availability, standard warranty, and use in critical applications of Texas Instruments semiconductor products and disclaimers thereto appears at the end of this data sheet.

All trademarks are the property of their respective owners.



These devices have limited built-in ESD protection. The leads should be shorted together or the device placed in conductive foam during storage or handling to prevent electrostatic damage to the MOS gates.

Absolute Maximum Ratings ⁽¹⁾⁽²⁾

Supply Voltage, V_{CC}	7V
Control Input Voltages	7V
Driver Input Voltage	7V
Driver Output Voltages	+15V/-10V
Receiver Input Voltages	+15V/-10V
Receiver Output Voltage	5.5V
Continuous Power Dissipation @ 25°C	
D0008A Package	630 mW ⁽³⁾
Storage Temp. Range	-65°C to +150°C
Lead Temp. (Soldering 4 seconds)	260°C

- (1) "Absolute maximum ratings" are those beyond which the safety of the device cannot be verified. They are not meant to imply that the device should be operated at these limits. The tables of "Electrical Characteristics" provide conditions for actual device operation.
- (2) If Military/Aerospace specified devices are required, please contact the Texas Instruments Sales Office/ Distributors for availability and specifications.
- (3) Derate linearly at 6.5 mW/°C to 337 mW at 70°C.

Recommended Operating Conditions

	Min	Max	Units
Supply Voltage, V_{CC}	4.75	5.25	V
Bus Voltage	-7	+12	V
Operating Free Air Temperature (T_A)			
Commercial (DS3695AM)	0	+70	°C
Industrial (DS3695ATM)	-40	+85	°C
Commercial (DS3696AM)	0	+70	°C

Electrical Characteristics ^{(1) (2)}

0°C ≤ T_A ≤ 70°C, 4.75V < V_{CC} < 5.25V unless otherwise specified

Parameter		Test Conditions	Min	Typ	Max	Units	
V_{OD1}	Differential Driver Output Voltage (Unloaded)	$I_O = 0$			5	V	
V_{OD2}	Differential Driver Output Voltage (with Load)	$R = 50\Omega$; (RS-422) ⁽³⁾	2			V	
		$R = 27\Omega$; (RS-485)	1.5			V	
ΔV_{OD}	Complementary Output States Differential Output Voltage For Change in Magnitude of Driver	$R = 27\Omega$			0.2	V	
V_{OC}	Driver Common Mode Output Voltage				3.0	V	
$\Delta V_{OC} $	Change in Magnitude of Driver Common Mode Output Voltage For Complementary Output States				0.2	V	
V_{IH}	Input High Voltage	$DI, DE, \overline{RE},$ RE/DE	2			V	
V_{IL}	Input Low Voltage				0.8	V	
V_{CL}	Input Clamp Voltage		$I_{IN} = -18$ mA			-1.5	V
I_{IL}	Input Low Current		$V_{IL} = 0.4$ V			-200	μA
I_{IH}	Input High Current		$V_{IH} = 2.4$ V			20	μA

- (1) All currents into device pins are positive; all currents out of device pins are negative. All voltages are referenced to device ground unless otherwise specified.
- (2) All typicals are given for $V_{CC} = 5$ V and $T_A = 25$ °C.
- (3) All limits for which this note is applied must be derated by 10% for DS3695AT. Other parameters remain the same for this extended temperature range device (-40°C ≤ T_A ≤ +85°C).

Electrical Characteristics ⁽¹⁾ ⁽²⁾ (continued)
 $0^{\circ}\text{C} \leq T_A \leq 70^{\circ}\text{C}$, $4.75\text{V} < V_{CC} < 5.25\text{V}$ unless otherwise specified

Parameter			Test Conditions	Min	Typ	Max	Units		
I_{IN}	Input Current	$\overline{RI}, \overline{RI}, DO/RI,$	$V_{CC} = 0\text{V}$ or 5.25V , DE or $\overline{RE}/DE = 0\text{V}$			$V_{IN} = 12\text{V}$	+1.0	mA	
		$\overline{DO}/\overline{RI}$				$V_{IN} = -7\text{V}$	-0.8	mA	
V_{TH}	Differential Input Threshold Voltage for Receiver		$-7\text{V} \leq V_{CM} \leq +12\text{V}$	-0.2		+0.2	V		
ΔV_{TH}	Receiver Input Hysteresis		$V_{CM} = 0\text{V}$		70		mV		
V_{OH}	Receiver Output High Voltage		$I_{OH} = -400\ \mu\text{A}$	2.4			V		
V_{OL}	Output Low Voltage	RO	$I_{OL} = 16\ \text{mA}^{(3)}$			0.5	V		
		\overline{TS}	$I_{OL} = 8\ \text{mA}$			0.45	V		
I_{OZR}	Output Current at Receiver OFF-State (High Impedance)		$0.4\text{V} \leq V_O \leq 2.4\text{V}$, $V_{CC} = \text{Max}$,			± 20	μA		
R_{IN}	Receiver Input Resistance		$-7\text{V} \leq V_{CM} \leq +12\text{V}$	12			k Ω		
I_{CC}	Supply Current		No Load ⁽³⁾			Driver Outputs Enabled	42	60	mA
						Driver Outputs Disabled	27	40	mA
I_{OSD}	Output Current Driver Short-Circuit		$V_O = -7\text{V}^{(3)}$			-250	mA		
			$V_O = +12\text{V}^{(3)}$			+250	mA		
I_{OSR}	Output Current Receiver Short-Circuit		$V_O = 0\text{V}$	-15		-85	mA		

Receiver Switching Characteristics
 $0^{\circ}\text{C} \leq T_A \leq 70^{\circ}\text{C}$, $4.75\text{V} < V_{CC} < 5.25\text{V}$ unless otherwise specified ⁽⁴⁾

Symbol	Test Conditions	Min	Typ	Max	Units
t_{PLH}	$C_L = 15\ \text{pF}$	15	28	42	ns
t_{PHL}	S1 and S2	15	28	42	ns
$ t_{PLH} - t_{PHL} $	Closed	0	3		ns
t_{PLZ}	$C_L = 15\ \text{pF}$, S2 Open	5	29	35	ns
t_{PHZ}	$C_L = 15\ \text{pF}$, S1 Open	5	12	16	ns
t_{PZL}	$C_L = 15\ \text{pF}$, S2 Open	7	15	28	ns
t_{PZH}	$C_L = 15\ \text{pF}$, S1 Open	7	15	20	ns

⁽⁴⁾ All typicals are given for $V_{CC} = 5\text{V}$ and $T_A = 25^{\circ}\text{C}$.

Driver Switching Characteristics
 $0^{\circ}\text{C} \leq T_A \leq 70^{\circ}\text{C}$, $4.75\text{V} < V_{CC} < 5.25\text{V}$ unless otherwise specified ⁽¹⁾

Symbol	Test Conditions	Min	Typ	Max	Units
SINGLE ENDED CHARACTERISTICS (Figure 7, Figure 8, and Figure 10)					
t_{PLH}	$R_{LDIFF} = 60\ \Omega$	9	15	22	ns
t_{PHL}	$C_{L1} = C_{L2} = 100\ \text{pF}$	9	15	22	ns
$t_{SKEW} t_{PLH} - t_{PHL} $		0	2	8	ns
t_{PLZ}	$C_L = 15\ \text{pF}$, S2 Open	7	15	30	ns
t_{PHZ}	$C_L = 15\ \text{pF}$, S1 Open	7	15	30	ns
t_{PZL}	$C_L = 100\ \text{pF}$, S2 Open	30	35	50	ns
t_{PZH}	$C_L = 100\ \text{pF}$, S1 Open	30	35	50	ns
DIFFERENTIAL SWITCHING CHARACTERISTICS (Figure 10)					
t_r, t_f	$R_{LDIFF} = 60\ \Omega$ $C_{L1} = C_{L2} = 100\ \text{pF}$	6	10	18	ns

⁽¹⁾ All typicals are given for $V_{CC} = 5\text{V}$ and $T_A = 25^{\circ}\text{C}$.

AC TEST CIRCUITS AND SWITCHING WAVEFORMS

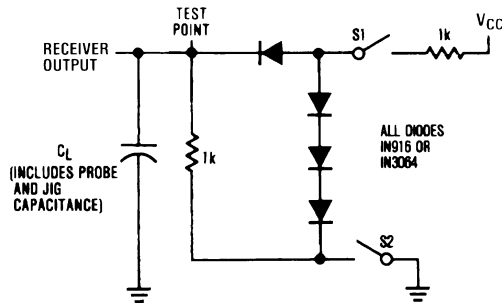
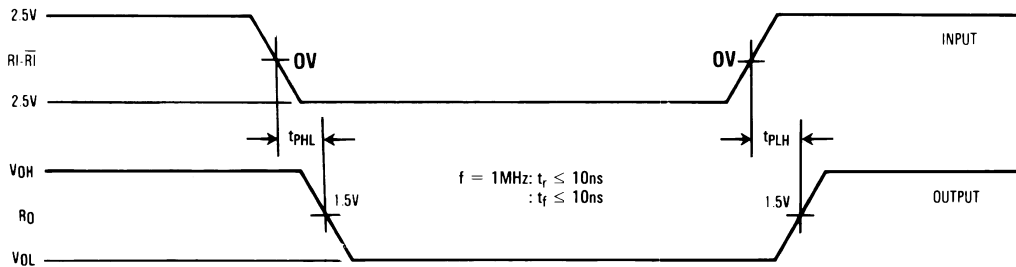

Figure 3. Receiver Propagation Delay Test Circuit



Differential input voltage may be realized by grounding \overline{RI} and pulsing RI between +2.5V and -2.5V

Figure 4. Receiver Input-to-Output Propagation Delay Timing

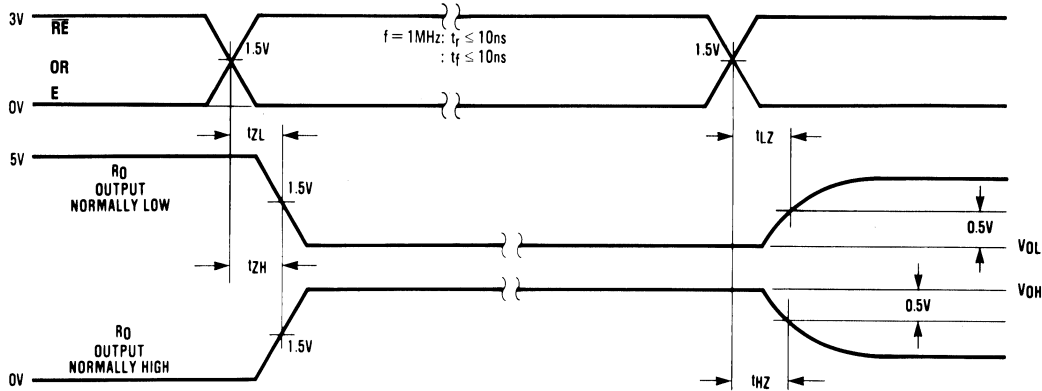

Figure 5. Receiver Enable/Disable Propagation Delay Timing

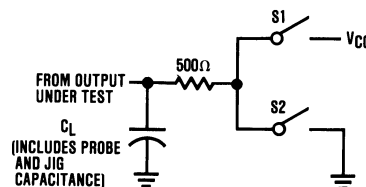

Figure 6. Unless Otherwise Specified the Switches are Closed

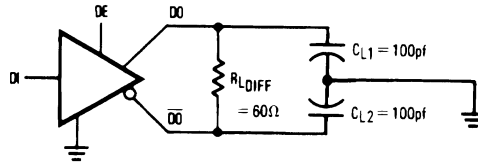
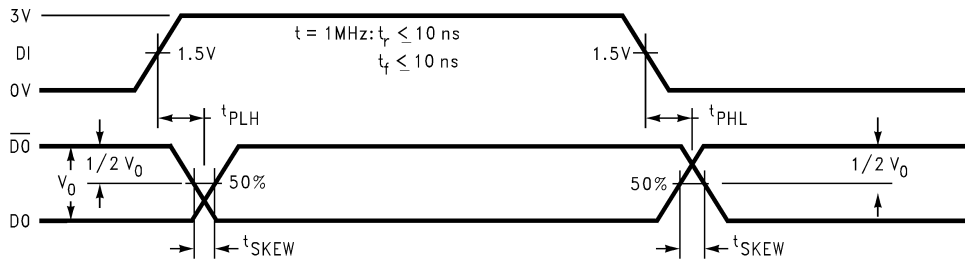

Figure 7. Driver Propagation Delay Test Circuits



t_{PLH} and t_{PHL} are measured to the respective 50% points. t_{SKEW} is the difference between propagation delays of the complementary outputs.

Figure 8. Driver Input-to-Output Propagation Delay Timing (Single-Ended)

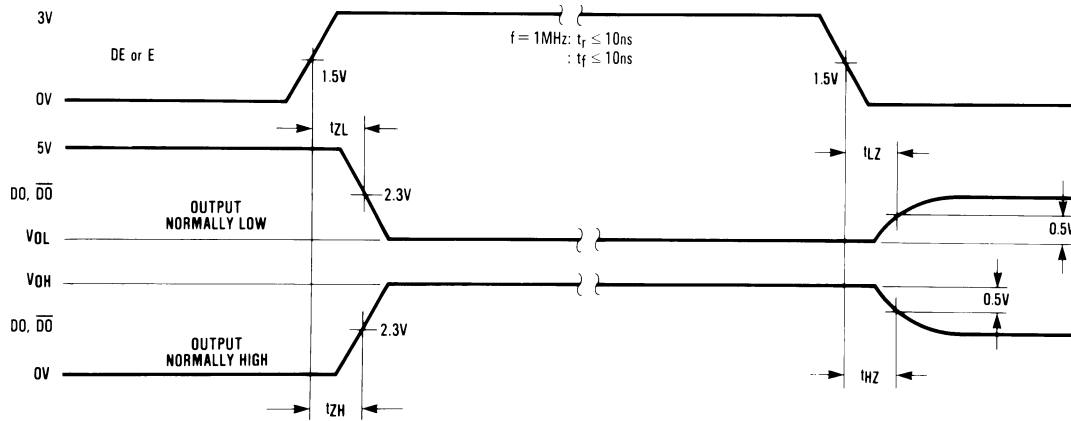

Figure 9. Driver Enable/Disable Propagation Delay Timing

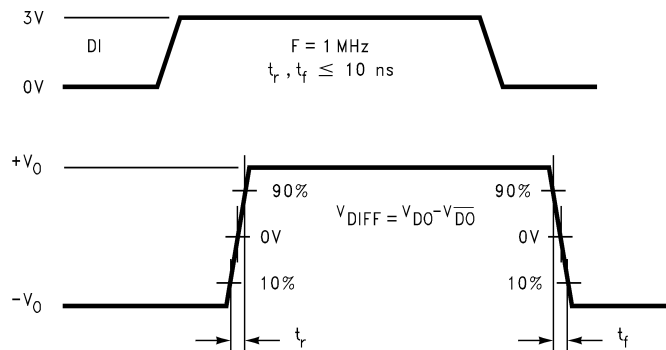

Figure 10. Driver Differential Transition Timing

Table 1. Function Tables DS3695A/DS3696A Transmitting⁽¹⁾

Inputs			Line	Outputs		
\overline{RE}	DE	DI	Condition	\overline{DO}	DO	\overline{TS}^* (DS3696A Only)
X	1	1	No Fault	0	1	H
X	1	0	No Fault	1	0	H
X	0	X	X	Z	Z	H
X	1	X	Fault	Z	Z	L

Table 2. Function Tables DS3695A/DS3696A Receiving⁽¹⁾

Inputs			Line	Outputs	
\overline{RE}	DE	$RI-\overline{RI}$		RO	\overline{TS}^* (DS3696A Only)
0	0	$\geq +0.2V$		1	H
0	0	$\leq -0.2V$		0	H
0	0	Inputs Open**		1	H
1	0	X		Z	H

- (1) X — Don't care condition
 Z — High impedance state
 Fault — Improper line conditions causing excessive power dissipation in the driver, such as shorts or bus contention situations
 * \overline{TS} is an "open collector" output with an on-chip 10 k Ω pull-up resistor.
**** This is a fail safe condition**
- (1) X — Don't care condition
 Z — High impedance state
 Fault — Improper line conditions causing excessive power dissipation in the driver, such as shorts or bus contention situations
 * \overline{TS} is an "open collector" output with an on-chip 10 k Ω pull-up resistor.
**** This is a fail safe condition**

Typical Application

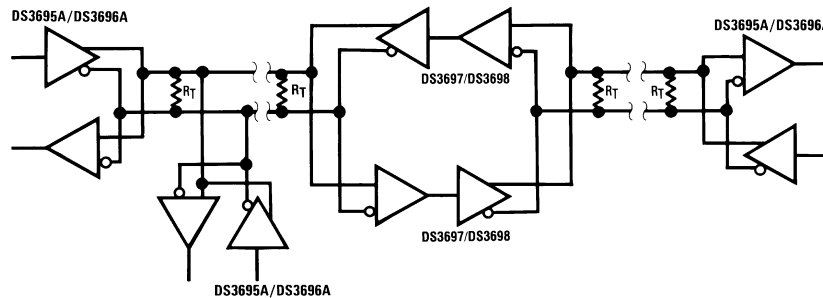



Repeater control logic not shown.

Figure 11.

REVISION HISTORY

Changes from Revision B (April 2013) to Revision C	Page
• Changed layout of National Data Sheet to TI format	6

PACKAGING INFORMATION

Orderable Device	Status (1)	Package Type	Package Drawing	Pins	Package Qty	Eco Plan (2)	Lead finish/ Ball material (6)	MSL Peak Temp (3)	Op Temp (°C)	Device Marking (4/5)	Samples
DS3695AM/NOPB	ACTIVE	SOIC	D	8	95	RoHS & Green	SN	Level-1-260C-UNLIM	0 to 70	DS36 95AM	
DS3695AMX/NOPB	ACTIVE	SOIC	D	8	2500	RoHS & Green	SN	Level-1-260C-UNLIM	0 to 70	DS36 95AM	

(1) The marketing status values are defined as follows:

ACTIVE: Product device recommended for new designs.

LIFEBUY: TI has announced that the device will be discontinued, and a lifetime-buy period is in effect.

NRND: Not recommended for new designs. Device is in production to support existing customers, but TI does not recommend using this part in a new design.

PREVIEW: Device has been announced but is not in production. Samples may or may not be available.

OBSOLETE: TI has discontinued the production of the device.

(2) **RoHS:** TI defines "RoHS" to mean semiconductor products that are compliant with the current EU RoHS requirements for all 10 RoHS substances, including the requirement that RoHS substance do not exceed 0.1% by weight in homogeneous materials. Where designed to be soldered at high temperatures, "RoHS" products are suitable for use in specified lead-free processes. TI may reference these types of products as "Pb-Free".

RoHS Exempt: TI defines "RoHS Exempt" to mean products that contain lead but are compliant with EU RoHS pursuant to a specific EU RoHS exemption.

Green: TI defines "Green" to mean the content of Chlorine (Cl) and Bromine (Br) based flame retardants meet JS709B low halogen requirements of <=1000ppm threshold. Antimony trioxide based flame retardants must also meet the <=1000ppm threshold requirement.

(3) MSL, Peak Temp. - The Moisture Sensitivity Level rating according to the JEDEC industry standard classifications, and peak solder temperature.

(4) There may be additional marking, which relates to the logo, the lot trace code information, or the environmental category on the device.

(5) Multiple Device Markings will be inside parentheses. Only one Device Marking contained in parentheses and separated by a "~" will appear on a device. If a line is indented then it is a continuation of the previous line and the two combined represent the entire Device Marking for that device.

(6) Lead finish/Ball material - Orderable Devices may have multiple material finish options. Finish options are separated by a vertical ruled line. Lead finish/Ball material values may wrap to two lines if the finish value exceeds the maximum column width.

Important Information and Disclaimer:The information provided on this page represents TI's knowledge and belief as of the date that it is provided. TI bases its knowledge and belief on information provided by third parties, and makes no representation or warranty as to the accuracy of such information. Efforts are underway to better integrate information from third parties. TI has taken and continues to take reasonable steps to provide representative and accurate information but may not have conducted destructive testing or chemical analysis on incoming materials and chemicals. TI and TI suppliers consider certain information to be proprietary, and thus CAS numbers and other limited information may not be available for release.

In no event shall TI's liability arising out of such information exceed the total purchase price of the TI part(s) at issue in this document sold by TI to Customer on an annual basis.

TAPE AND REEL INFORMATION



QUADRANT ASSIGNMENTS FOR PIN 1 ORIENTATION IN TAPE



*All dimensions are nominal

Device	Package Type	Package Drawing	Pins	SPQ	Reel Diameter (mm)	Reel Width W1 (mm)	A0 (mm)	B0 (mm)	K0 (mm)	P1 (mm)	W (mm)	Pin1 Quadrant
DS3695AMX/NOPB	SOIC	D	8	2500	330.0	12.4	6.5	5.4	2.0	8.0	12.0	Q1

TAPE AND REEL BOX DIMENSIONS



*All dimensions are nominal

Device	Package Type	Package Drawing	Pins	SPQ	Length (mm)	Width (mm)	Height (mm)
DS3695AMX/NOPB	SOIC	D	8	2500	367.0	367.0	35.0



D0008A

PACKAGE OUTLINE

SOIC - 1.75 mm max height

SMALL OUTLINE INTEGRATED CIRCUIT



4214825/C 02/2019

NOTES:

- Linear dimensions are in inches [millimeters]. Dimensions in parenthesis are for reference only. Controlling dimensions are in inches. Dimensioning and tolerancing per ASME Y14.5M.
- This drawing is subject to change without notice.
- This dimension does not include mold flash, protrusions, or gate burrs. Mold flash, protrusions, or gate burrs shall not exceed $.006$ [0.15] per side.
- This dimension does not include interlead flash.
- Reference JEDEC registration MS-012, variation AA.

EXAMPLE BOARD LAYOUT

D0008A

SOIC - 1.75 mm max height

SMALL OUTLINE INTEGRATED CIRCUIT



LAND PATTERN EXAMPLE
EXPOSED METAL SHOWN
SCALE:8X



SOLDER MASK DETAILS

4214825/C 02/2019

NOTES: (continued)

6. Publication IPC-7351 may have alternate designs.

7. Solder mask tolerances between and around signal pads can vary based on board fabrication site.

EXAMPLE STENCIL DESIGN

D0008A

SOIC - 1.75 mm max height

SMALL OUTLINE INTEGRATED CIRCUIT



SOLDER PASTE EXAMPLE
BASED ON .005 INCH [0.125 MM] THICK STENCIL
SCALE:8X

4214825/C 02/2019

NOTES: (continued)

8. Laser cutting apertures with trapezoidal walls and rounded corners may offer better paste release. IPC-7525 may have alternate design recommendations.
9. Board assembly site may have different recommendations for stencil design.

IMPORTANT NOTICE AND DISCLAIMER

TI PROVIDES TECHNICAL AND RELIABILITY DATA (INCLUDING DATASHEETS), DESIGN RESOURCES (INCLUDING REFERENCE DESIGNS), APPLICATION OR OTHER DESIGN ADVICE, WEB TOOLS, SAFETY INFORMATION, AND OTHER RESOURCES "AS IS" AND WITH ALL FAULTS, AND DISCLAIMS ALL WARRANTIES, EXPRESS AND IMPLIED, INCLUDING WITHOUT LIMITATION ANY IMPLIED WARRANTIES OF MERCHANTABILITY, FITNESS FOR A PARTICULAR PURPOSE OR NON-INFRINGEMENT OF THIRD PARTY INTELLECTUAL PROPERTY RIGHTS.

These resources are intended for skilled developers designing with TI products. You are solely responsible for (1) selecting the appropriate TI products for your application, (2) designing, validating and testing your application, and (3) ensuring your application meets applicable standards, and any other safety, security, or other requirements. These resources are subject to change without notice. TI grants you permission to use these resources only for development of an application that uses the TI products described in the resource. Other reproduction and display of these resources is prohibited. No license is granted to any other TI intellectual property right or to any third party intellectual property right. TI disclaims responsibility for, and you will fully indemnify TI and its representatives against, any claims, damages, costs, losses, and liabilities arising out of your use of these resources.

TI's products are provided subject to TI's Terms of Sale (www.ti.com/legal/termsofsale.html) or other applicable terms available either on ti.com or provided in conjunction with such TI products. TI's provision of these resources does not expand or otherwise alter TI's applicable warranties or warranty disclaimers for TI products.

Mailing Address: Texas Instruments, Post Office Box 655303, Dallas, Texas 75265
Copyright © 2020, Texas Instruments Incorporated