

INTERNATIONAL RECTIFIER



2N681 & 2N5204 SERIES

25 and 35 Amp RMS SCRs

Major Ratings and Characteristics

	2N681-92	2N5204-07	Units
I_T (RMS)	25	35	A
I_T (AV)	16*	22*	A
@ T_C	-65 to 65*	-40 to 40	°C
I_{TSM}			A
@ 50 Hz	145	285	
@ 60 Hz	150*	300*	
i^2t			A ² -s
@ 50 Hz	103	410	
@ 60 Hz	94	375	
I_{GT}	40	40	mA
dv/dt	—	100*	V/ μ s
di/dt	75–100	100	A/ μ s
T_J	-65 to 125*	-40 to 125*	°C
V_{RRM} , V_{DRM} range	25–800	600–1200	V

*JEDEC registered value.

Description/Features

- General purpose stud mounted
- Broad forward and reverse voltage range – through 1200 volts
- Can be supplied to meet stringent military, aerospace and other high-reliability requirements

CASE STYLE AND DIMENSIONS

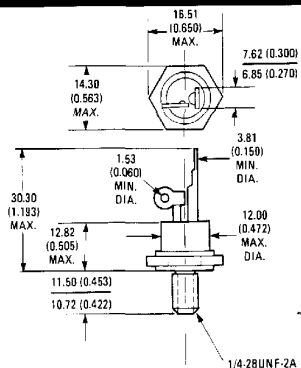
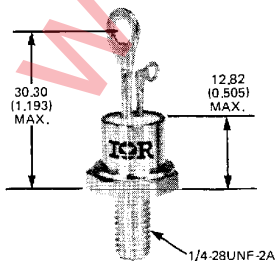

Conforms to JEDEC Outline TO-208AA (TO-48)
Dimensions in Millimeters and (Inches)

VOLTAGE RATINGS (Applied gate voltage zero or negative)

Part Numbers	V_{RRM} , V_{DRM} - Max. Repetitive Peak Reverse and Off-State Voltage (V)	V_{RSM} Max. Non Repetitive Peak Reverse Voltage $t_p < 5$ ms (V)
	$T_J = -65^{\circ}\text{C}$ to 125°C	$T_J = -65^{\circ}\text{C}$ to 125°C
2N681	25*	35*
2N682	50*	75*
2N683	100*	150*
2N685	200*	300*
2N687	300*	400*
2N688	400*	500*
2N689	500*	600*
2N690	600*	720*
2N691	700*	840*
2N692	800*	960*
	$T_J = -40^{\circ}\text{C}$ to 125°C	$T_J = -40^{\circ}\text{C}$ to 125°C
2N5204	600	720
2N5205	800	960
2N5206	1000	1200
2N5207	1200	1440

ELECTRICAL SPECIFICATIONS

		2N681-92	2N5204-07	Units	Conditions
ON-STATE					
$I_T(\text{RMS})$	Max. RMS on-state current	25	35	A	
$I_T(\text{AV})$	Max. average on-state current	16*	22*	A	
	@ $T_C =$	-65 to 65*	-40 to 40*	$^{\circ}\text{C}$	180° half sine wave conduction
I_{TSM}	Max. peak one cycle, non-repetitive surge current	145	285	A	50 Hz half cycle sine wave or 6 ms rectangular pulse
		150*	300*		60 Hz half cycle sine wave or 5 ms rectangular pulse
		170	340		50 Hz half cycle sine wave or 6 ms rectangular pulse
		180	355		60 Hz half cycle sine wave or 5 ms rectangular pulse
I_{2t}	Max. I_{2t} capability, for fusing	103	410	A^2s	$t = 10$ ms Rated V_{RRM} applied following surge, initial $T_J = 125^{\circ}\text{C}$
		94	375		$t = 8.3$ ms
I_{2t}	Max. I_{2t} capability, for individual device fusing	145	580	A^2s	$t = 10$ ms $V_{RRM} = 0$ following surge, initial $T_J = 125^{\circ}\text{C}$
		135	530		$t = 8.3$ ms
$I_{2\sqrt{t}}$	Max. $I_{2\sqrt{t}}$ capability, for individual device fusing $\text{\textcircled{1}}$	1450	5800	$\text{A}^2\sqrt{\text{s}}$	$t = 0.1$ to 10 ms initial $T_J \leq 125^{\circ}\text{C}$ V_{RRM} following surge = 0.
V_{TM}	Max. peak on-state voltage	2*	2.3*	V	$T_J = 25^{\circ}\text{C}$, $I_T(\text{AV}) = 16\text{A}$ (50A peak) 2N681, $I_T(\text{AV}) = 22\text{A}$ (70A peak) 2N5204
I_H	Max. holding current	20 @ 25°C [†]	200* @ -40°C	mA	Anode supply = 24V, initial $I_T = 1.0\text{A}$.
BLOCKING					
dv/dt	Min. critical rate-of-rise of off-state voltage	100 [†]	100*	V/ μs	$T_J = 125^{\circ}\text{C}$. Exponential to 100% rated V_{DRM}
		250 [†]	250		$T_J = 125^{\circ}\text{C}$. Exponential to 67% rated V_{DRM}
Gate open circuited.					

*JEDEC Registered value.

 $\text{\textcircled{1}}$ I_{2t} for time $t_x = I_{2\sqrt{t}} \cdot \sqrt{t_x}$.[†] Typical

ELECTRICAL SPECIFICATIONS (Continued)

		2N681-92	2N5204-07	Units	Conditions	
BLOCKING (Continued)						
$I_{R(-)}$ & $I_{D(-)}$ Max. reverse and off-state current V_{RRM} & $V_{DRM} =$	5V	$I_{R(AV)}$ & $I_{D(AV)}$ (Average Values)	I_{RM} & I_{DM} (Peak Values)	mA	$T_J = 125^{\circ}\text{C}$, gate open circuited.	
	25 to 150V	6.5*	—			
	200 & 250V	6.0*	—			
	300V	5.0*	—			
	400V	4.0*	—			
	500V	3.0*	—			
	600V	2.5*	3.3*			
	700V	2.25*	—			
	800V	2.0*	2.5*			
	1000V	—	2.0*			
1200V	—	1.7*				
SWITCHING						
t_d	Typical delay time	1	1	μs	$T_C = 25^{\circ}\text{C}$, $V_{DM} = \text{rated } V_{DRM}$, $I_{TM} = 10\text{A}$ dc resistive circuit. Gate pulse: 10V, 40 Ω source, $t_p = 6 \mu\text{s}$, $t_r = 0.1 \mu\text{s}$.	
di/dt	Max. non-repetitive rate of rise of turned-on current $V_{DM} =$	25 to 600V	100	—	A/ μs	$T_C = 125^{\circ}\text{C}$, $V_{DM} = \text{rated } V_{DRM}$, $I_{TM} = 2 \times di/dt$. Gate pulse: 20V, 15 Ω , $t_p = 6 \mu\text{s}$, $t_r = 0.1 \mu\text{s}$ max. Per JEDEC standard RS-397, 5.2.2.6.
		700 to 800V	75	—		
		—	100		$T_C = 125^{\circ}\text{C}$, $V_{DM} = 600\text{V}$, $I_{TM} = 200\text{A}$ @ 400 Hz, max., Gate pulse: 20V, 15 Ω , $t_p = 6 \mu\text{s}$, $t_r = 0.1 \mu\text{s}$ max. Per JEDEC standard RS-397, 5.2.2.6.	
TRIGGERING						
P_{GM}	Max. peak gate power	5*	60*	W	$t_p \leq 5$ ms for 2N681 series; $t_p \leq 500 \mu\text{s}$ for 2N5204 series.	
$P_{G(AV)}$	Max. average gate power	0.5*	0.5*	W		
$+I_{GM}$	Max. peak positive gate current	2*	2	A		
$+V_{GM}$	Max. peak positive gate voltage	10*	—	V		
$-V_{GM}$	Max. peak negative gate voltage	5*	5*	V		
I_{GT}	Max. required DC gate current to trigger	80*	80*	mA	$T_C = \text{min. rated value}$. Max. required gate trigger current is the lowest value which will trigger all units with +6V anode-to-cathode. $T_C = 25^{\circ}\text{C}$ $T_C = 125^{\circ}\text{C}$	
		40	40			
		18.5	20			
	Typical DC gate current to trigger	30	30	$T_C = 25^{\circ}\text{C}$ +6V anode-to-cathode		
V_{GT}	Max. required DC gate voltage to trigger	3*	3*	V	$T_C = -65^{\circ}\text{C}$. Max. required gate trigger voltage is the lowest value which will trigger all units with +6V anode-to-cathode. $T_C = 25^{\circ}\text{C}$	
		2	2			
	Typical DC gate voltage to trigger	1.5	1.5	$T_C = 25^{\circ}\text{C}$ +6V anode-to-cathode		
V_{GD}	Max. DC gate voltage not to trigger	0.25*	0.25*	V	$T_C = 125^{\circ}\text{C}$. Max. gate voltage not to trigger is the maximum value which will not trigger any unit with rated V_{DRM} anode-to-cathode.	

THERMAL-MECHANICAL SPECIFICATIONS

		2N681-92	2N5204-07	Units	Conditions
T_J	Operating junction temperature range	-65° to 125°	-40° to 125°	°C	
T_{stg}	Storage temperature range	-65° to 125°	-40° to 125°	°C	
R_{thJC}	Max. internal thermal resistance, junction to case	1.5	1.5*	deg. C/W	DC operation
R_{thCS}	Thermal resistance, case to sink	0.35	0.35	deg. C/W	Mounting surface smooth, flat and greased.
	Mounting torque to nut $\pm 10\%$	20,(27.5)		lbf · in.	Lubricated threads (non-lubricated threads).
		0.23(.32)		kgf · m	
		2.3(3.1)		N·m	
	to device	25		lbf · in.	Lubricated threads.
		0.29		kgf · m	
		2.8		N·m	
wt	Approximate weight	14(0.49)	14 (0.5)	g (oz.)	
	Case Style	TO-208AA (TO-48)			

*JEDEC Registered value.

2N681 Series

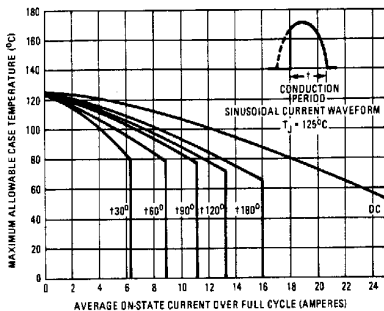

Fig. 1 – Maximum Allowable Case Temperature Vs. Average On-State Current, 2N681 Series

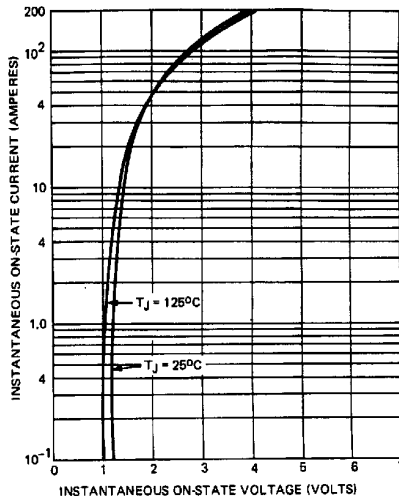

Fig. 2 – Maximum On-State Voltage Vs. Current, 2N681 Series

2N681 Series

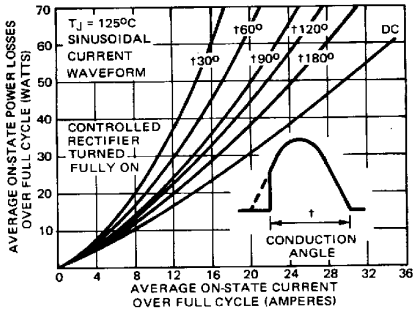

Fig. 3 — Maximum Low Level On-State Power Loss Vs. Current (Sinusoidal Current Waveform), 2N681 Series

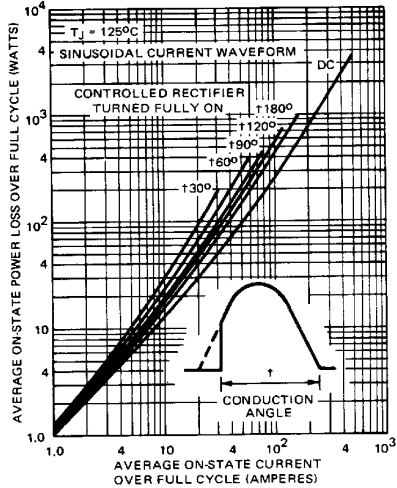

Fig. 4 — Maximum High Level On-State Power Loss Vs. Current (Sinusoidal Current Waveform), 2N681 Series

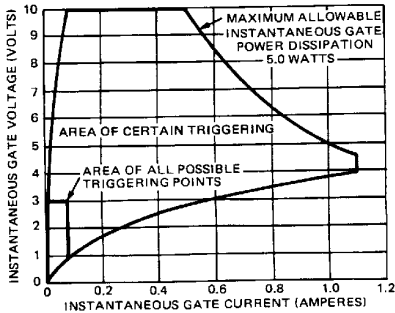

Fig. 5 — Gate Characteristics, 2N681 Series

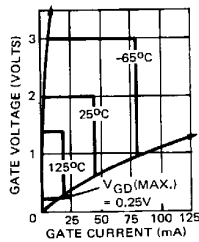

Fig. 5A — Area of All Possible Triggering Points Vs. Temperature 2N681 Series

2N681 Series

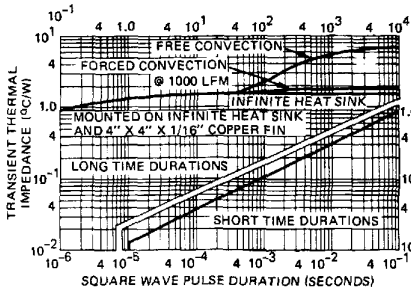

Fig. 6 – Maximum Transient Thermal Impedance, Junction to Case, Vs. Pulse Duration, 2N681 Series

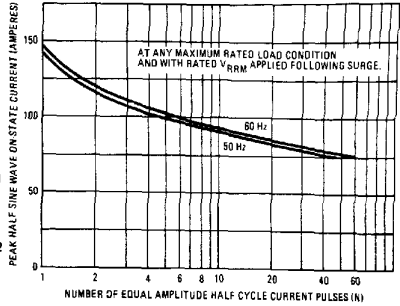

Fig. 7 – Maximum Non-Repetitive Surge Current, Vs. Number of Current Pulses, 2N681 Series

2N5204 Series

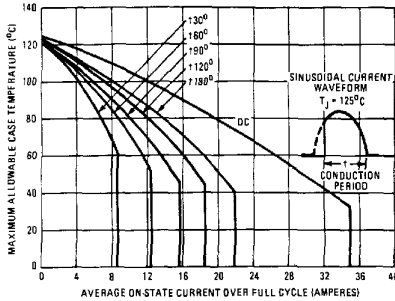

Fig. 8 – Maximum Allowable Case Temperature Vs. Average On-State Current (Sinusoidal Current Waveform), 2N5204 Series

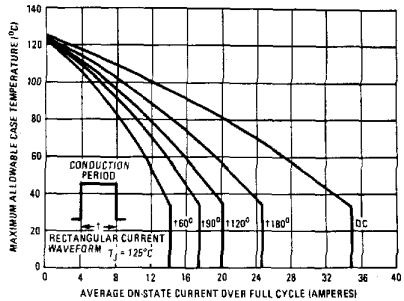

Fig. 9 – Maximum Allowable Case Temperature Vs. Average On-State Current (Rectangular Current Waveform), 2N5204 Series

2N5204 Series

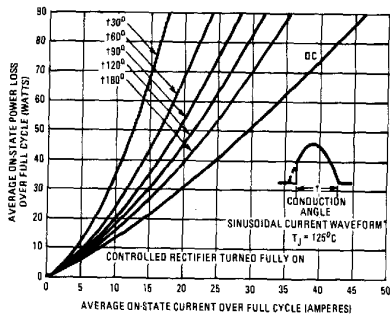

Fig. 10 — Maximum Low-Level On-State Power Loss Vs. Average On-State Current (Sinusoidal Current Waveform), 2N5204 Series

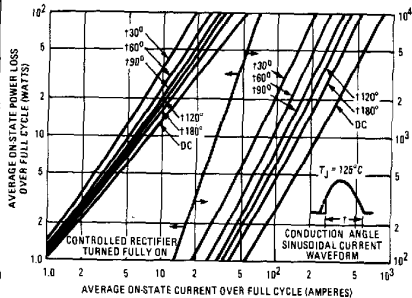

Fig. 11 — Maximum High-Level On-State Power Loss Vs. Average On-State Current (Sinusoidal Current Waveform), 2N5204 Series

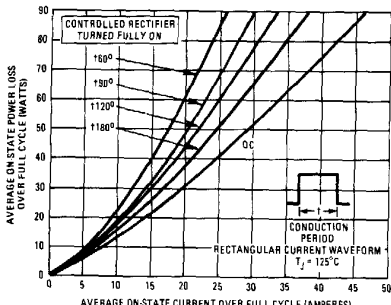

Fig. 12 — Maximum Low-Level On-State Power Loss Vs. Average On-State Current (Rectangular Current Waveform), 2N5204 Series

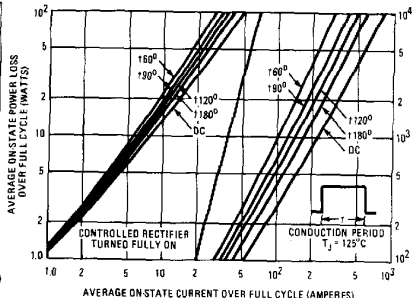

Fig. 13 — Maximum High-Level On-State Power Loss Vs. Average On-State Current (Rectangular Current Waveform), 2N5204 Series

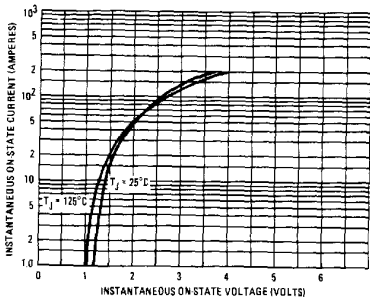

Fig. 14 — Maximum Instantaneous On-State Voltage Vs. Instantaneous On-State Current, 2N5204 Series

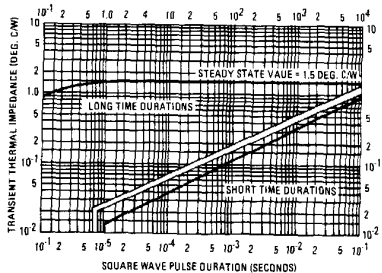

Fig. 15 — Maximum Transient Thermal Resistance, Junction to Case, Vs. Pulse Duration, 2N5204 Series