

INTERFACE AND SWITCHING APPLICATION.

FEATURES

- High density cell design for low $R_{DS(ON)}$.
- Voltage controlled small signal switch.
- Rugged and reliable.
- High saturation current capability.

MAXIMUM RATING ($T_a=25^\circ\text{C}$)

CHARACTERISTIC		SYMBOL	RATING	UNIT
Drain-Source Voltage		V_{DSS}	60	V
Drain-Gate Voltage ($R_{GS} = 1M\Omega$)		V_{DGR}	60	V
Gate-Source Voltage		V_{GSS}	± 20	V
Drain Current	Continuous	I_D	200	mA
	Pulsed	I_{DP}	500	
Drain Power Dissipation		P_D	400	mW
Junction Temperature		T_j	150	
Storage Temperature Range		T_{stg}	-55 150	

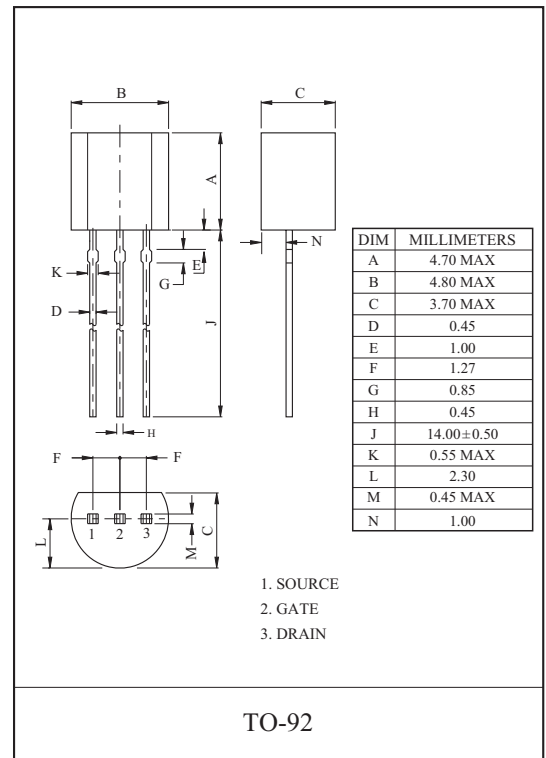

Datasheet.Directory

EQUIVALENT CIRCUIT

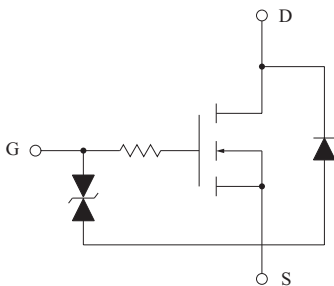

THIS TRANSISTOR IS ELECTROSTATIC SENSITIVE DEVICE.
PLEASE HANDLE WITH CAUTION.

ELECTRICAL CHARACTERISTICS ($T_a=25^\circ\text{C}$)

CHARACTERISTIC	SYMBOL	TEST CONDITION	MIN.	TYP.	MAX.	UNIT
Drain-Source Breakdown Voltage	BV_{DSS}	$V_{GS}=0V, I_D=10\ \mu A$	60	-	-	V
Zero Gate Voltage Drain Current	I_{DSS}	$V_{DS}=48V, V_{GS}=0V$	-	-	1	μA
Gate-Body Leakage, Forward	I_{GSSF}	$V_{GS}=15V, V_{DS}=0V$	-	-	1	μA
Gate-Body Leakage, Reverse	I_{GSSR}	$V_{GS}=-15V, V_{DS}=0V$	-	-	-1	μA

2N7000A

ELECTRICAL CHARACTERISTICS (Ta=25) ON CHARACTERISTICS (Note 1)

CHARACTERISTIC	SYMBOL	TEST CONDITION	MIN.	TYP.	MAX.	UNIT
Gate Threshold Voltage	V_{th}	$V_{DS}=V_{GS}$, $I_D=1mA$	0.8	2.1	3	V
Drain-Source ON Resistance	$R_{DS(ON)}$	$V_{GS}=10V$, $I_D=500mA$	-	1.2	5	
		$V_{GS}=4.5V$, $I_D=75mA$	-	1.8	5.3	
Drain-Source ON Voltage	$V_{DS(ON)}$	$V_{GS}=10V$, $I_D=500mA$	-	0.6	2.5	V
		$V_{GS}=4.5V$, $I_D=75mA$	-	0.14	0.4	
On State Drain Current	$I_{D(ON)}$	$V_{GS}=4.5V$, $V_{DS}=10V$	75	600	-	mA
Forward Transconductance	g_{FS}	$V_{DS}=10V$, $I_D=200mA$	100	320	-	mS
Drain-Source Diode Forward Voltage	V_{SD}	$V_{GS}=0V$, $I_S=200mA$	-	0.76	1.15	V

Note 1) Pulse Test : Pulse Width 300 μ s, Duty Cycle 2.0%

DYNAMIC CHARACTERISTICS

CHARACTERISTIC	SYMBOL	TEST CONDITION	MIN.	TYP.	MAX.	UNIT	
Input Capacitance	C_{iss}	$V_{DS}=25V$, $V_{GS}=0V$, $f=1MHz$	-	20	50	pF	
Reverse Transfer Capacitance	C_{rss}		-	4	5		
Output Capacitance	C_{oss}		-	11	25		
Switching Time	Turn-On Time	t_{on}	$V_{DD}=15V$, $R_L=25$, $I_D=200mA$, $V_{GS}=10V$, $R_{GEN}=25$	-	-	10	nS
	Turn-Off Time	t_{off}		-	-	10	

SWITCHING TIME TEST CIRCUIT

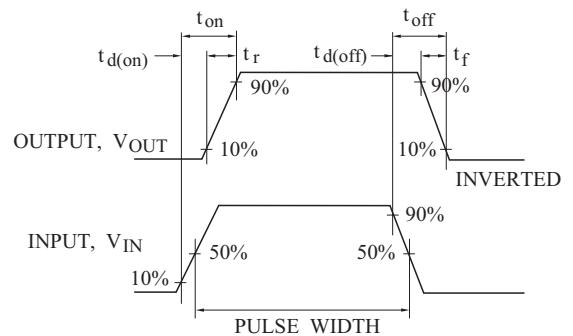
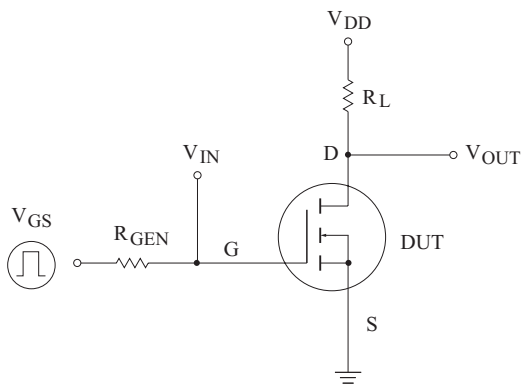

2N7000A

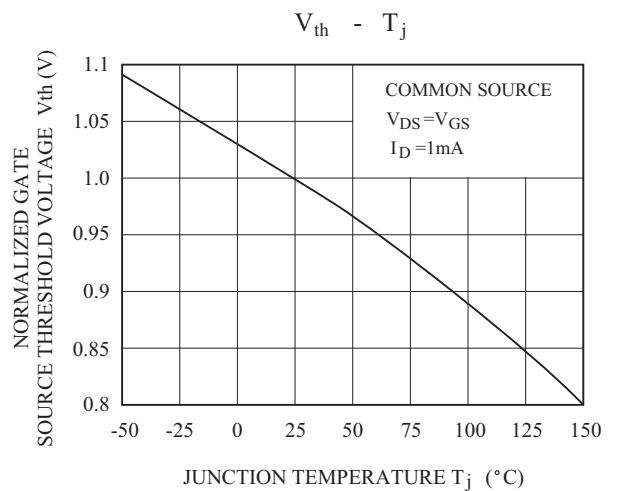
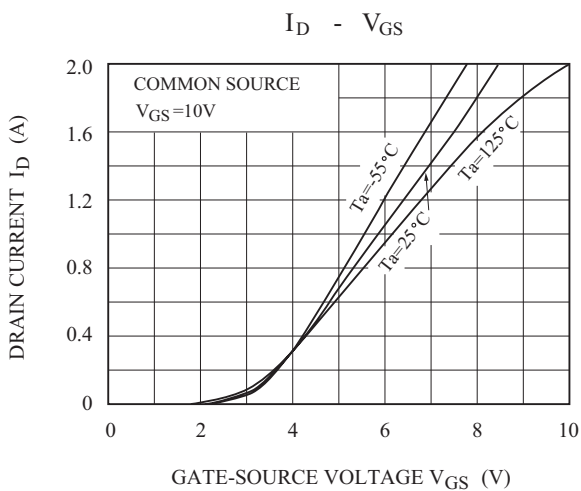
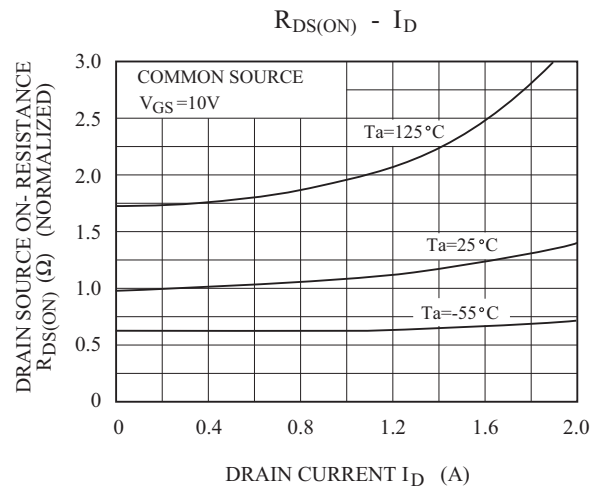
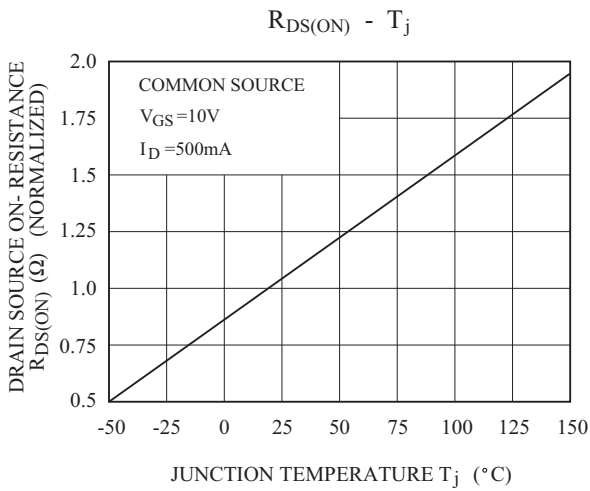
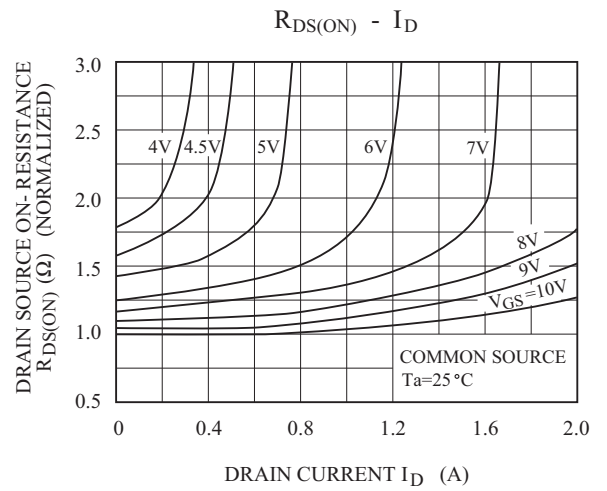
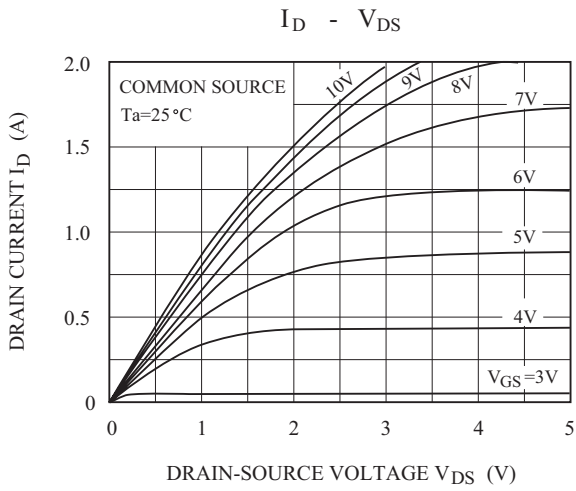

2N7000A

