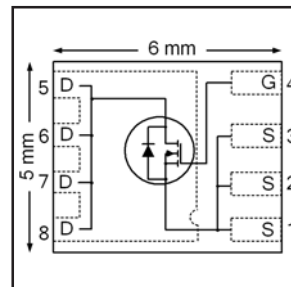


HEXFET® Power MOSFET

$V_{DS}$	<b>75</b>	<b>V</b>
$R_{DS(on) \text{ max}}$ (@ $V_{GS} = 10V$ )	<b>5.9</b>	<b>mΩ</b>
$Q_g$ (typical)	<b>65</b>	<b>nC</b>
$R_G$ (typical)	<b>1.2</b>	<b>Ω</b>
$I_D$ (@ $T_{mb} = 25^\circ C$ )	<b>100</b> Ⓢ	<b>A</b>



### Applications

- Secondary Side Synchronous Rectification
- Inverters for DC Motors
- DC-DC Brick Applications
- Boost Converters

### Features and Benefits

#### Features

Low $R_{DS(on)} (\leq 5.9m\Omega)$
Low Thermal Resistance to PCB ( $\leq 0.8^\circ C/W$ )
100% Rg tested
Low Profile ( $\leq 0.9 \text{ mm}$ )
Industry-Standard Pinout
Compatible with Existing Surface Mount Techniques
RoHS Compliant Containing no Lead, no Bromide and no Halogen
MSL1, Industrial Qualification

#### Benefits

Lower Conduction Losses
Enables Better Thermal Dissipation
Increased Reliability
Increased Power Density
Multi-Vendor Compatibility
Easier Manufacturing
Environmentally Friendlier
Increased Reliability

results in  
⇒

Base Part Number	Package Type	Standard Pack		Orderable Part Number
		Form	Quantity	
IRFH5007PBF	PQFN 5mm x 6mm	Tape and Reel	4000	IRFH5007TRPBF

### Absolute Maximum Ratings

	Parameter	Max.	Units
$V_{DS}$	Drain-to-Source Voltage	75	V
$V_{GS}$	Gate-to-Source Voltage	±20	
$I_D @ T_A = 25^\circ C$	Continuous Drain Current, $V_{GS} @ 10V$	17	A
$I_D @ T_A = 70^\circ C$	Continuous Drain Current, $V_{GS} @ 10V$	13	
$I_D @ T_{mb} = 25^\circ C$	Continuous Drain Current, $V_{GS} @ 10V$	100Ⓢ	
$I_D @ T_{mb} = 100^\circ C$	Continuous Drain Current, $V_{GS} @ 10V$	88	
$I_{DM}$	Pulsed Drain Current ①	400	
$P_D @ T_A = 25^\circ C$	Power Dissipation ⑤	3.6	W
$P_D @ T_{mb} = 25^\circ C$	Power Dissipation ⑤	156	
	Linear Derating Factor ⑤	0.029	W/°C
$T_J$	Operating Junction and	-55 to + 150	°C
$T_{STG}$	Storage Temperature Range		

Notes ① through ⑤ are on page 8

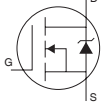
**Static @  $T_J = 25^\circ\text{C}$  (unless otherwise specified)**

	Parameter	Min.	Typ.	Max.	Units	Conditions
$BV_{DSS}$	Drain-to-Source Breakdown Voltage	75	—	—	V	$V_{GS} = 0V, I_D = 250\mu A$
$\Delta BV_{DSS}/\Delta T_J$	Breakdown Voltage Temp. Coefficient	—	0.09	—	V/ $^\circ\text{C}$	Reference to $25^\circ\text{C}, I_D = 1\text{mA}$
$R_{DS(on)}$	Static Drain-to-Source On-Resistance	—	5.1	5.9	m $\Omega$	$V_{GS} = 10V, I_D = 50A$ ③
$V_{GS(th)}$	Gate Threshold Voltage	2.0	—	4.0	V	$V_{DS} = V_{GS}, I_D = 150\mu A$
$\Delta V_{GS(th)}$	Gate Threshold Voltage Coefficient	—	-8.4	—	mV/ $^\circ\text{C}$	
$I_{DSS}$	Drain-to-Source Leakage Current	—	—	20	$\mu A$	$V_{DS} = 75V, V_{GS} = 0V$
		—	—	250		$V_{DS} = 75V, V_{GS} = 0V, T_J = 125^\circ\text{C}$
$I_{GSS}$	Gate-to-Source Forward Leakage	—	—	100	nA	$V_{GS} = 20V$
	Gate-to-Source Reverse Leakage	—	—	-100		$V_{GS} = -20V$
$g_{fs}$	Forward Transconductance	100	—	—	S	$V_{DS} = 15V, I_D = 50A$
$Q_g$	Total Gate Charge	—	65	98	nC	$V_{DS} = 38V$ $V_{GS} = 10V$ $I_D = 50A$ See Fig. 17 & 18
$Q_{gs1}$	Pre-Vth Gate-to-Source Charge	—	11	—		
$Q_{gs2}$	Post-Vth Gate-to-Source Charge	—	4.5	—		
$Q_{gd}$	Gate-to-Drain Charge	—	20	—		
$Q_{godr}$	Gate Charge Overdrive	—	29.5	—		
$Q_{sw}$	Switch Charge ( $Q_{gs2} + Q_{gd}$ )	—	24.5	—		
$Q_{oss}$	Output Charge	—	21	—	nC	$V_{DS} = 16V, V_{GS} = 0V$
$R_G$	Gate Resistance	—	1.2	—	$\Omega$	
$t_{d(on)}$	Turn-On Delay Time	—	10	—	ns	$V_{DD} = 38V, V_{GS} = 10V$ $I_D = 50A$ $R_G = 1.8\Omega$ See Fig. 15
$t_r$	Rise Time	—	14	—		
$t_{d(off)}$	Turn-Off Delay Time	—	30	—		
$t_f$	Fall Time	—	11	—		
$C_{iss}$	Input Capacitance	—	4290	—	pF	$V_{GS} = 0V$ $V_{DS} = 25V$ $f = 1.0\text{MHz}$
$C_{oss}$	Output Capacitance	—	510	—		
$C_{rss}$	Reverse Transfer Capacitance	—	210	—		

**Avalanche Characteristics**

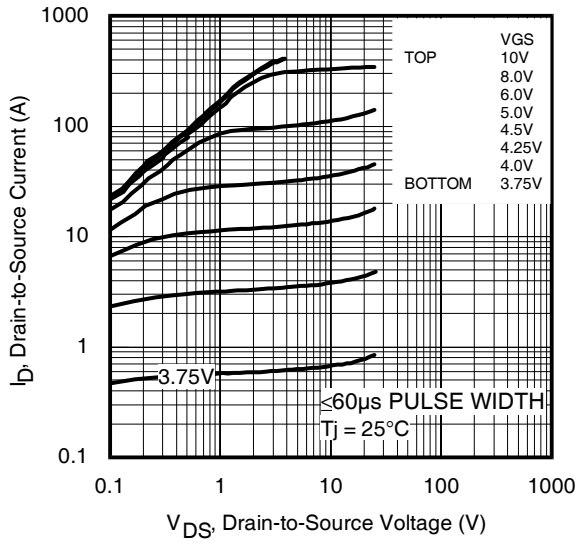
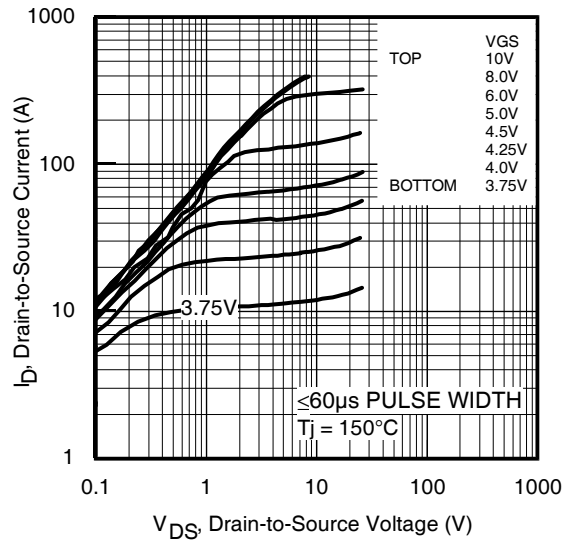
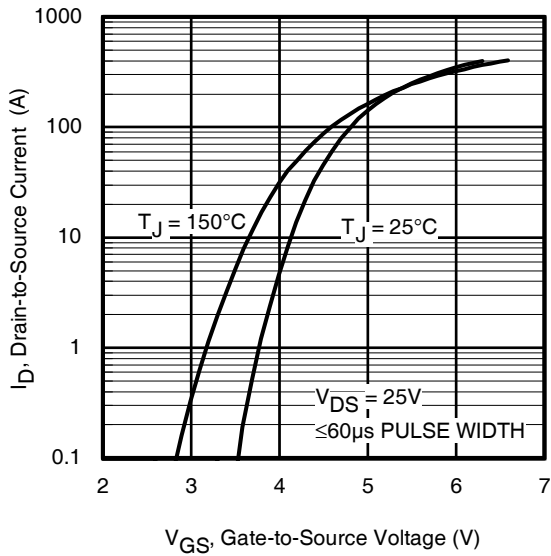
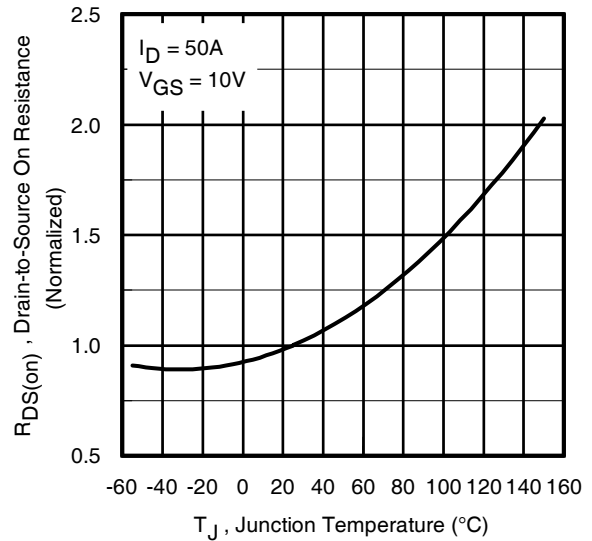
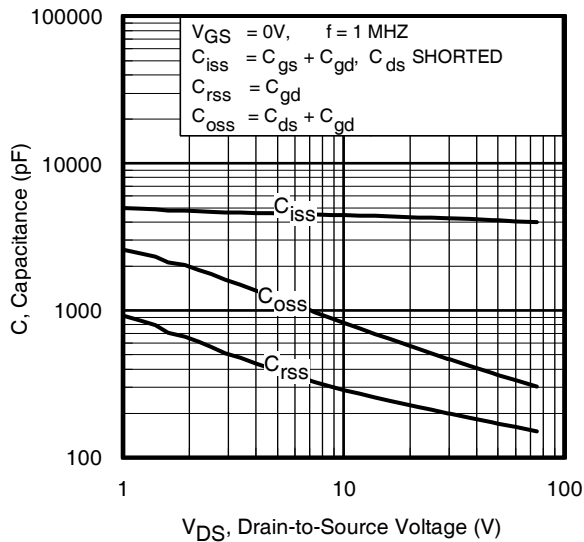
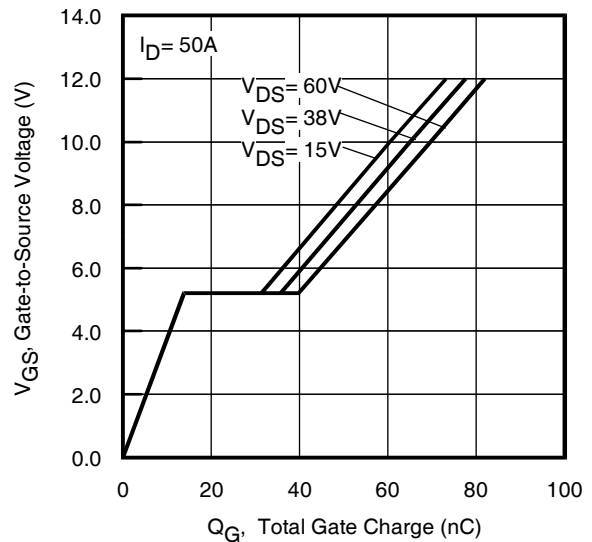
	Parameter	Typ.	Max.	Units
$E_{AS}$	Single Pulse Avalanche Energy ②	—	250	mJ
$I_{AR}$	Avalanche Current ①	—	50	A

**Diode Characteristics**

	Parameter	Min.	Typ.	Max.	Units	Conditions
$I_S$	Continuous Source Current (Body Diode) ⑥	—	—	100	A	MOSFET symbol showing the integral reverse p-n junction diode. 
$I_{SM}$	Pulsed Source Current (Body Diode) ①	—	—	400		
$V_{SD}$	Diode Forward Voltage	—	—	1.3	V	$T_J = 25^\circ\text{C}, I_S = 50A, V_{GS} = 0V$ ③
$t_{rr}$	Reverse Recovery Time	—	31	47	ns	$T_J = 25^\circ\text{C}, I_F = 50A, V_{DD} = 38V$
$Q_{rr}$	Reverse Recovery Charge	—	170	255	nC	$di/dt = 500A/\mu s$ ③
$t_{on}$	Forward Turn-On Time	Time is dominated by parasitic Inductance				

**Thermal Resistance**

	Parameter	Typ.	Max.	Units
$R_{\theta JC-mb}$	Junction-to-Mounting Base	0.5	0.8	$^\circ\text{C/W}$
$R_{\theta JC}$ (Top)	Junction-to-Case ④	—	15	
$R_{\theta JA}$	Junction-to-Ambient ⑤	—	35	
$R_{\theta JA} (<10s)$	Junction-to-Ambient ⑤	—	22	


**Fig 1. Typical Output Characteristics**

**Fig 2. Typical Output Characteristics**

**Fig 3. Typical Transfer Characteristics**

**Fig 4. Normalized On-Resistance vs. Temperature**

**Fig 5. Typical Capacitance vs. Drain-to-Source Voltage**

**Fig 6. Typical Gate Charge vs. Gate-to-Source Voltage**

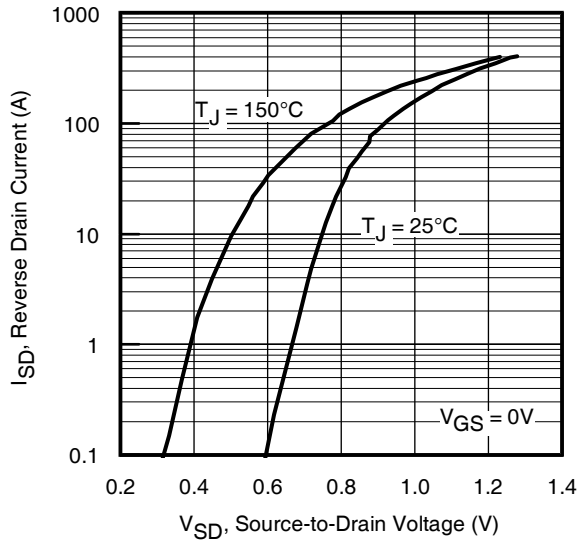


Fig 7. Typical Source-Drain Diode Forward Voltage

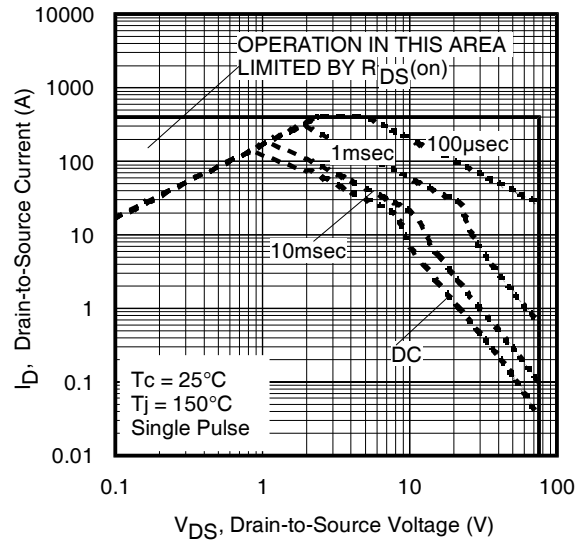


Fig 8. Maximum Safe Operating Area

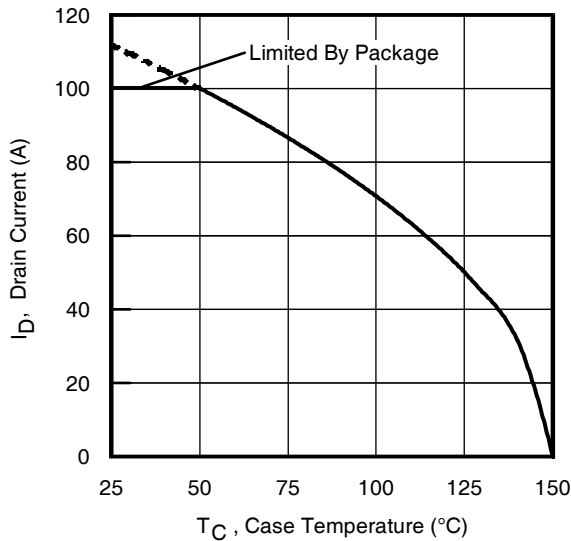


Fig 9. Maximum Drain Current vs. Case Temperature

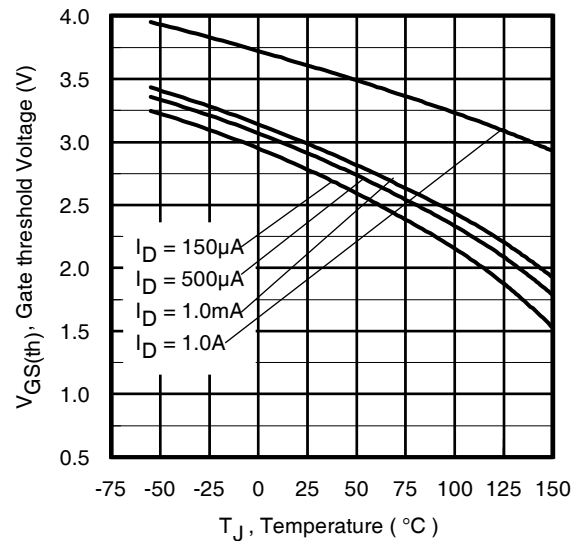


Fig 10. Threshold Voltage vs. Temperature

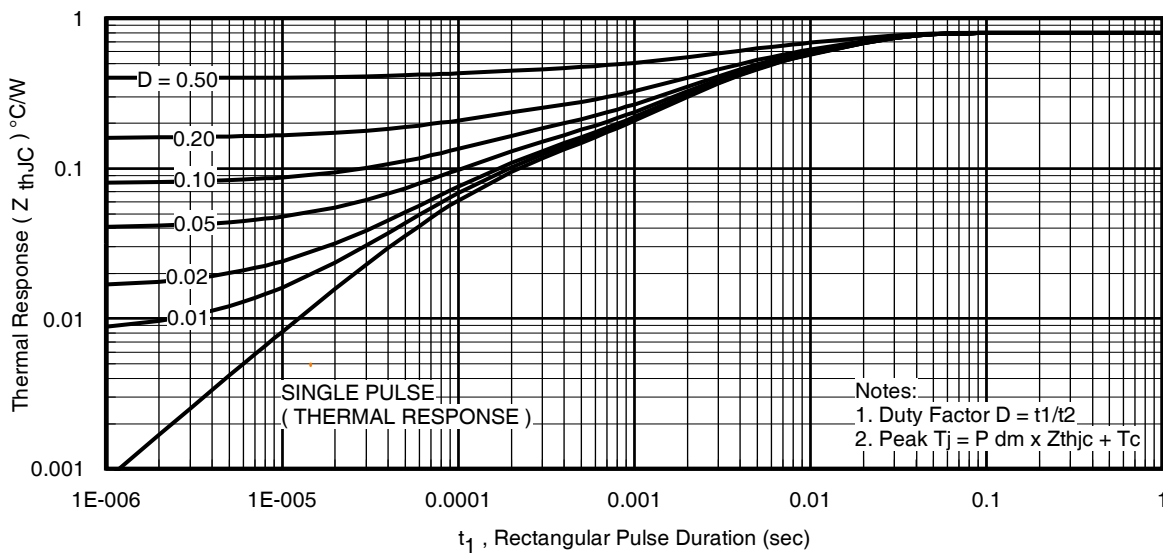
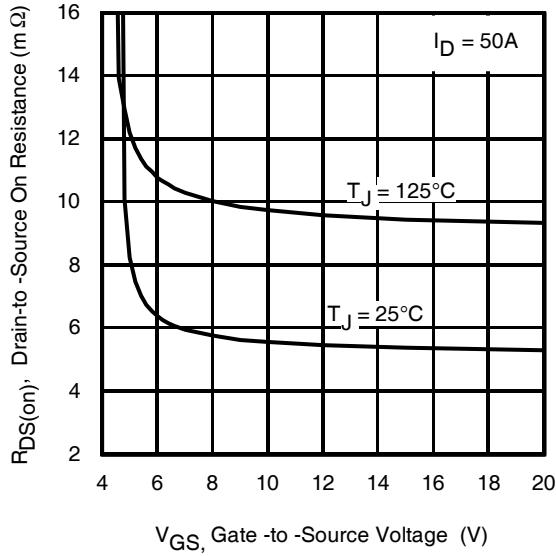
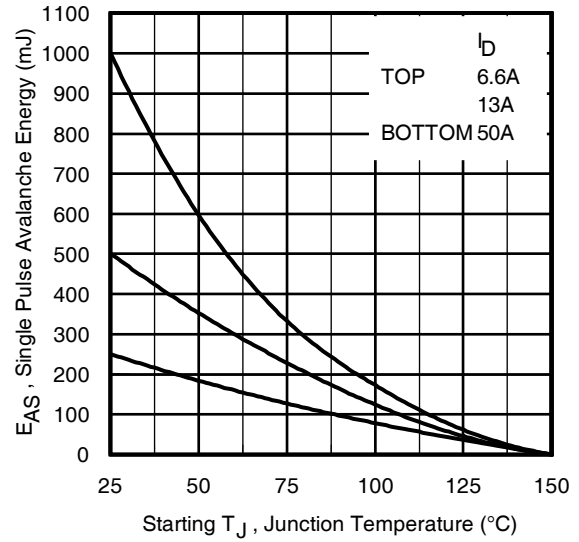
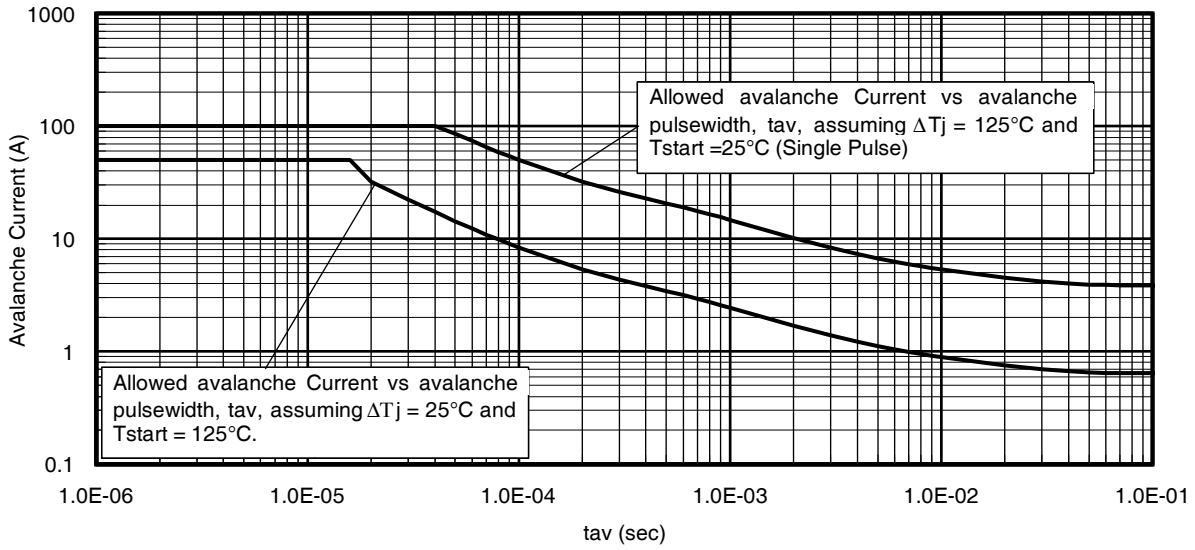
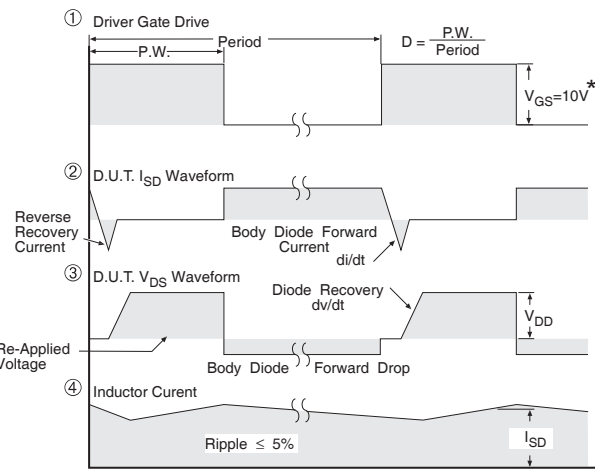
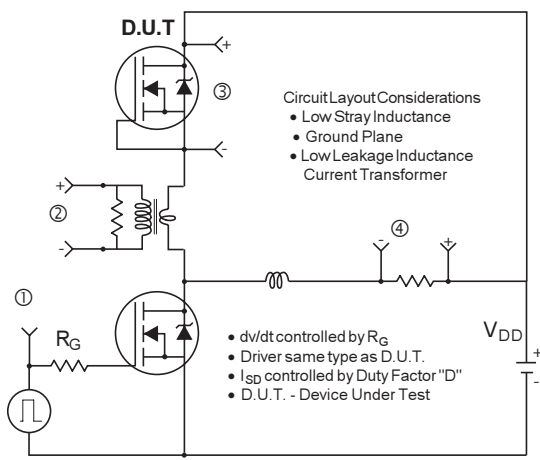


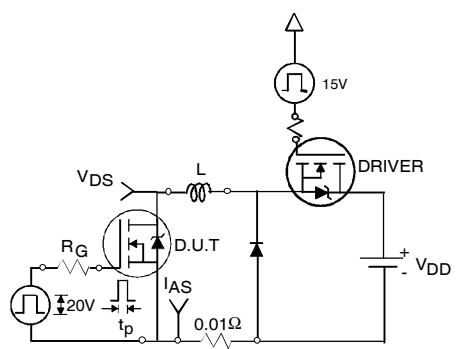
Fig 11. Maximum Effective Transient Thermal Impedance, Junction-to-Mounting Base


**Fig 12.** On-Resistance vs. Gate Voltage

**Fig 13.** Maximum Avalanche Energy vs. Drain Current

**Fig 14.** Typical Avalanche Current vs. Pulsewidth

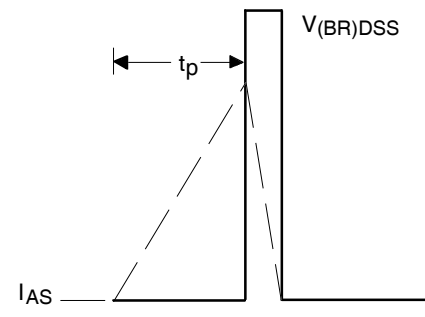


\*  $V_{GS} = 5V$  for Logic Level Devices

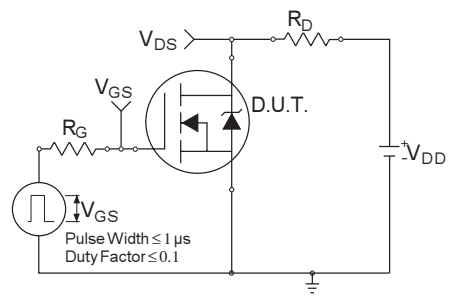
**Fig 15. Peak Diode Recovery dv/dt Test Circuit for N-Channel HEXFET® Power MOSFETs**



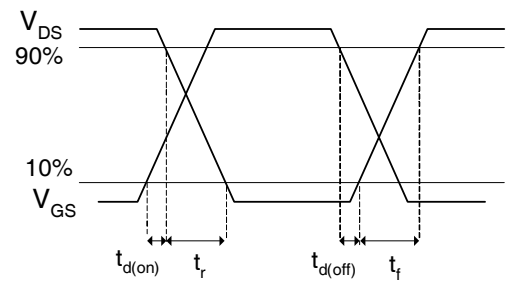
**Fig 16a. Unclamped Inductive Test Circuit**



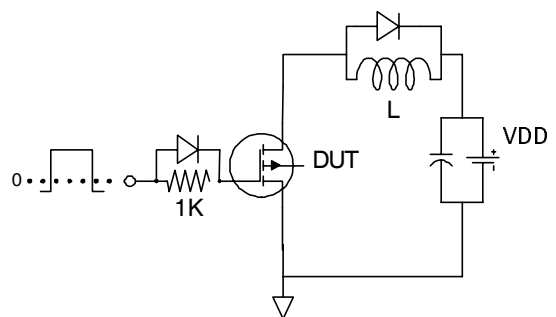
**Fig 16b. Unclamped Inductive Waveforms**



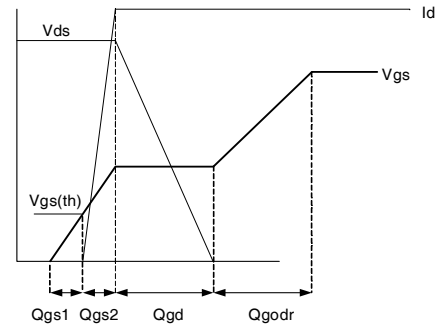
**Fig 17a. Switching Time Test Circuit**



**Fig 17b. Switching Time Waveforms**

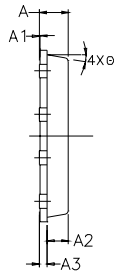


**Fig 18a. Gate Charge Test Circuit**

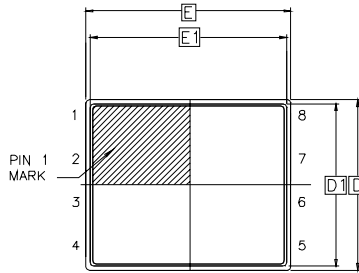


**Fig 18b. Gate Charge Waveform**

## PQFN 5x6 Outline "B" Package Details

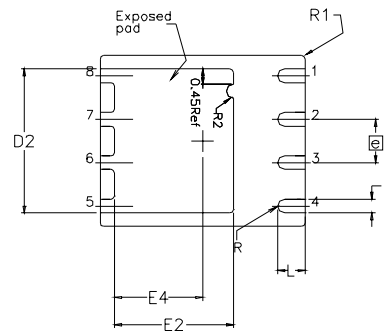


SIDE VIEW



TOP VIEW

DIM SYMBOL	MIN	NOM	MAX
A	0.800	0.830	1.05
A1	0.000	0.020	0.050
A2	0.580	0.630	0.680
A3		0.254 REF	
Ø	0"	10"	12"
b	0.350	0.400	0.470
D	4.850	5.000	5.150
D1	4.675	4.750	5.000
D2	3.700	4.210	4.300
e		1.270 BSC	
E	5.850	6.000	6.150
E1	5.675	5.750	6.000
E2	3.380	3.480	3.760
E4	2.480	2.580	2.680
L	0.550	0.800	0.900
R		0.200 REF	
R1		0.100 REF	
R2	0.150	0.200	0.250



BOTTOM VIEW

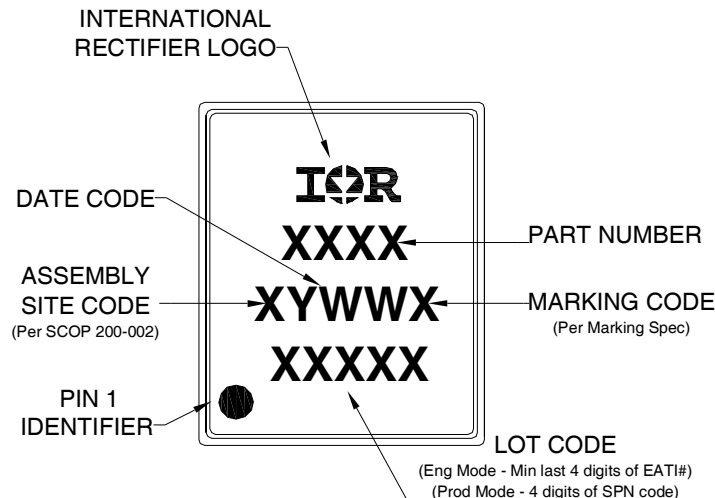
For more information on board mounting, including footprint and stencil recommendation, please refer to application note AN-1136:

<http://www.irf.com/technical-info/appnotes/an-1136.pdf>

For more information on package inspection techniques, please refer to application note AN-1154:

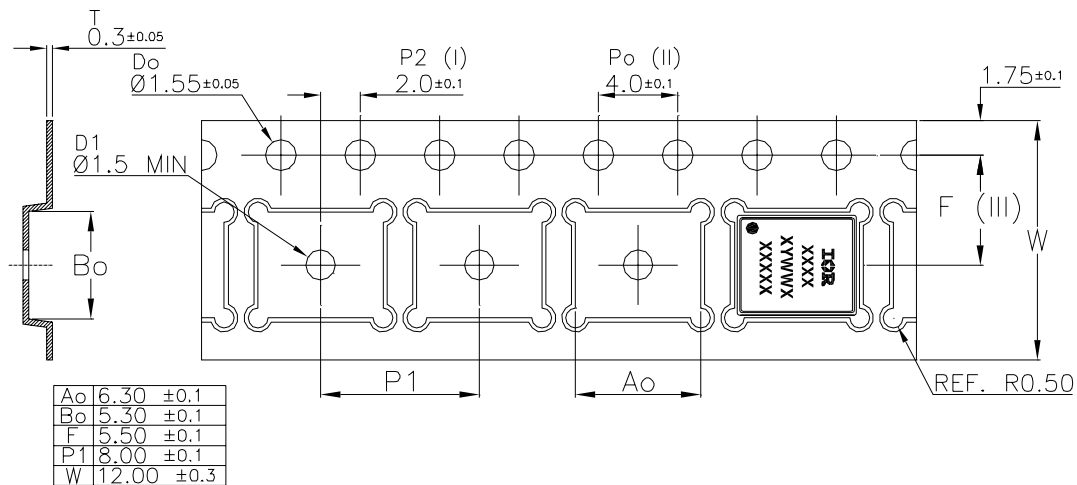
<http://www.irf.com/technical-info/appnotes/an-1154.pdf>

## PQFN 5x6 Outline "B" Part Marking



Note: For the most current drawing please refer to IR website at: <http://www.irf.com/package/>

## PQFN 5x6 Outline "B" Tape and Reel



### Qualification information<sup>†</sup>

Qualification level	Industrial (per JEDEC JESD47F <sup>††</sup> guidelines)	
Moisture Sensitivity Level	PQFN 5mm x 6mm	MSL1 (per JEDEC J-STD-020D <sup>††</sup> )
RoHS compliant	Yes	

<sup>†</sup> Qualification standards can be found at International Rectifier's web site  
<http://www.irf.com/product-info/reliability>

<sup>††</sup> Applicable version of JEDEC standard at the time of product release.

### Notes:

- ① Repetitive rating; pulse width limited by max. junction temperature.
- ② Starting  $T_J = 25^\circ\text{C}$ ,  $L = 0.20\text{mH}$ ,  $R_G = 25\Omega$ ,  $I_{AS} = 50\text{A}$ .
- ③ Pulse width  $\leq 400\mu\text{s}$ ; duty cycle  $\leq 2\%$ .
- ④  $R_\theta$  is measured at  $T_J$  of approximately  $90^\circ\text{C}$ .
- ⑤ When mounted on 1 inch square 2 oz copper pad on 1.5x1.5 in. board of FR-4 material.
- ⑥ Calculated continuous current based on maximum allowable junction temperature. Package is limited to 100A by production test capability.