

2N7000 / 2N7002 / NDS7002A
N-Channel Enhancement Mode Field Effect Transistor

General Description

These N-Channel enhancement mode field effect transistors are produced using Fairchild's proprietary, high cell density, DMOS technology. These products have been designed to minimize on-state resistance while provide rugged, reliable, and fast switching performance. They can be used in most applications requiring up to 400mA DC and can deliver pulsed currents up to 2A. These products are particularly suited for low voltage, low current applications such as small servo motor control, power MOSFET gate drivers, and other switching applications.

Features

- High density cell design for low $R_{DS(ON)}$
- Voltage controlled small signal switch.
- Rugged and reliable.
- High saturation current capability.

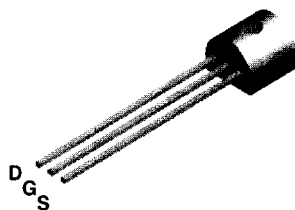

TO-92
2N7000

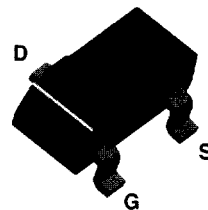

SOT-23
(TO-236AB)
2N7002/NDS7002A

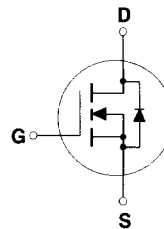

Absolute Maximum Ratings

$T_A = 25^\circ\text{C}$ unless otherwise noted

| Symbol | Parameter | 2N7000 | 2N7002 | NDS7002A | Units |
|----------------|---|------------|--------|----------|------------------|
| V_{DS} | Drain-Source Voltage | 60 | | | V |
| V_{DGR} | Drain-Gate Voltage ($R_{GS} \leq 1 \text{ M}\Omega$) | 60 | | | V |
| V_{GSS} | Gate-Source Voltage - Continuous | ± 20 | | | V |
| | - Non Repetitive ($t_p < 50 \text{ s}$) | ± 40 | | | |
| I_D | Maximum Drain Current - Continuous | 200 | 115 | 280 | mA |
| | - Pulsed | 500 | 800 | 1500 | |
| P_D | Maximum Power Dissipation | 400 | 200 | 300 | mW |
| | Derated above 25°C | 3.2 | 1.6 | 2.4 | |
| T_J, T_{STG} | Operating and Storage Temperature Range | -55 to 150 | | | $^\circ\text{C}$ |
| T_L | Maximum Lead Temperature for Soldering Purposes, 1/16" from Case for 10 Seconds | 300 | | | $^\circ\text{C}$ |

THERMAL CHARACTERISTICS

| Symbol | Parameter | 2N7000 | 2N7002 | NDS7002A | Units |
|-----------------|---|--------|--------|----------|--------------------|
| $R_{\theta JA}$ | Thermal Resistance, Junction-to-Ambient | 312.5 | 625 | 417 | $^\circ\text{C/W}$ |

Electrical Characteristics ($T_A = 25^\circ\text{C}$ unless otherwise noted)

| Symbol | Parameter | Conditions | Type | Min | Typ | Max | Units |
|----------------------------|---------------------------------|--|--------------------|-----|-----|------|---------------|
| OFF CHARACTERISTICS | | | | | | | |
| BV_{DSS} | Drain-Source Breakdown Voltage | $V_{GS} = 0\text{ V}, I_D = 10\ \mu\text{A}$ | All | 60 | | | V |
| I_{DSS} | Zero Gate Voltage Drain Current | $V_{DS} = 48\text{ V}, V_{GS} = 0\text{ V}$ | 2N7000 | | | 1 | μA |
| | | $T_J = 125^\circ\text{C}$ | | | | 1 | mA |
| | | $V_{DS} = 60\text{ V}, V_{GS} = 0\text{ V}$ | 2N7002 NDS7002A | | | 1 | μA |
| | | $T_J = 125^\circ\text{C}$ | | | | 0.5 | mA |
| I_{GSSF} | Gate - Body Leakage, Forward | $V_{GS} = 15\text{ V}, V_{DS} = 0\text{ V}$ | 2N7000 | | | 10 | nA |
| | | $V_{GS} = 20\text{ V}, V_{DS} = 0\text{ V}$ | 2N7002 NDS7002A | | | 100 | nA |
| I_{GSSR} | Gate - Body Leakage, Reverse | $V_{GS} = -15\text{ V}, V_{DS} = 0\text{ V}$ | 2N7000 | | | -10 | nA |
| | | $V_{GS} = -20\text{ V}, V_{DS} = 0\text{ V}$ | 2N7002 NDS7002A | | | -100 | nA |

ON CHARACTERISTICS (Note 1)

| | | | | | | | |
|---------------------------|-----------------------------------|---|--------------------|-----|------|------|----------|
| $V_{GS(TH)}$ | Gate Threshold Voltage | $V_{DS} = V_{GS}, I_D = 1\text{ mA}$ | 2N7000 | 0.8 | 2.1 | 3 | V |
| | | $V_{DS} = V_{GS}, I_D = 250\ \mu\text{A}$ | 2N7002 NDS7002A | 1 | 2.1 | 2.5 | |
| $R_{DS(ON)}$ | Static Drain-Source On-Resistance | $V_{GS} = 10\text{ V}, I_D = 500\text{ mA}$ | 2N7000 | | 1.2 | 5 | Ω |
| | | $T_J = 125^\circ\text{C}$ | | | 1.9 | 9 | |
| | | $V_{GS} = 4.5\text{ V}, I_D = 75\text{ mA}$ | | 1.8 | 5.3 | | |
| | | $V_{GS} = 10\text{ V}, I_D = 500\text{ mA}$ | 2N7002 | | 1.2 | 7.5 | |
| | | $T_J = 100^\circ\text{C}$ | | | 1.7 | 13.5 | |
| | | $V_{GS} = 5.0\text{ V}, I_D = 50\text{ mA}$ | | 1.7 | 7.5 | | |
| | | $T_J = 100^\circ\text{C}$ | | 2.4 | 13.5 | | |
| | | $V_{GS} = 10\text{ V}, I_D = 500\text{ mA}$ | NDS7002A | | 1.2 | 2 | |
| $T_J = 125^\circ\text{C}$ | | 2 | | 3.5 | | | |
| $V_{DS(ON)}$ | Drain-Source On-Voltage | $V_{GS} = 10\text{ V}, I_D = 500\text{ mA}$ | 2N7000 | | 0.6 | 2.5 | V |
| | | $V_{GS} = 4.5\text{ V}, I_D = 75\text{ mA}$ | | | 0.14 | 0.4 | |
| | | $V_{GS} = 10\text{ V}, I_D = 500\text{ mA}$ | 2N7002 | | 0.6 | 3.75 | |
| | | $V_{GS} = 5.0\text{ V}, I_D = 50\text{ mA}$ | | | 0.09 | 1.5 | |
| | | $V_{GS} = 10\text{ V}, I_D = 500\text{ mA}$ | NDS7002A | | 0.6 | 1 | |
| | | $V_{GS} = 5.0\text{ V}, I_D = 50\text{ mA}$ | | | 0.09 | 0.15 | |

| Electrical Characteristics ($T_A = 25^\circ\text{C}$ unless otherwise noted) | | | | | | | |
|---|---|--|-------------------|-----|------|-----|-------|
| Symbol | Parameter | Conditions | Type | Min | Typ | Max | Units |
| ON CHARACTERISTICS Continued (Note 1) | | | | | | | |
| $I_{D(ON)}$ | On-State Drain Current | $V_{GS} = 4.5\text{ V}, V_{DS} = 10\text{ V}$ | 2N7000 | 75 | 600 | | mA |
| | | $V_{GS} = 10\text{ V}, V_{DS} \geq 2 V_{DS(on)}$ | 2N7002 | 500 | 2700 | | |
| | | $V_{GS} = 10\text{ V}, V_{DS} \geq 2 V_{DS(on)}$ | NDS7002A | 500 | 2700 | | |
| g_{FS} | Forward Transconductance | $V_{DS} = 10\text{ V}, I_D = 200\text{ mA}$ | 2N7000 | 100 | 320 | | mS |
| | | $V_{DS} \geq 2 V_{DS(on)}, I_D = 200\text{ mA}$ | 2N7002 | 80 | 320 | | |
| | | $V_{DS} \geq 2 V_{DS(on)}, I_D = 200\text{ mA}$ | NDS7002A | 80 | 320 | | |
| DYNAMIC CHARACTERISTICS | | | | | | | |
| C_{iss} | Input Capacitance | $V_{DS} = 25\text{ V}, V_{GS} = 0\text{ V},$ $f = 1.0\text{ MHz}$ | All | | 20 | 50 | pF |
| C_{oss} | Output Capacitance | | All | | 11 | 25 | pF |
| C_{riss} | Reverse Transfer Capacitance | | All | | 4 | 5 | pF |
| t_{on} | Turn-On Time | $V_{DD} = 15\text{ V}, R_L = 25\ \Omega,$ $I_D = 500\text{ mA}, V_{GS} = 10\text{ V},$ $R_{GEN} = 25$ | 2N7000 | | | 10 | ns |
| | | $V_{DD} = 30\text{ V}, R_L = 150\ \Omega,$ $I_D = 200\text{ mA}, V_{GS} = 10\text{ V},$ $R_{GEN} = 25\ \Omega$ | 2N700 NDS7002A | | | 20 | |
| t_{off} | Turn-Off Time | $V_{DD} = 15\text{ V}, R_L = 25\ \Omega,$ $I_D = 500\text{ mA}, V_{GS} = 10\text{ V},$ $R_{GEN} = 25$ | 2N7000 | | | 10 | ns |
| | | $V_{DD} = 30\text{ V}, R_L = 150\ \Omega,$ $I_D = 200\text{ mA}, V_{GS} = 10\text{ V},$ $R_{GEN} = 25\ \Omega$ | 2N700 NDS7002A | | | 20 | |
| DRAIN-SOURCE DIODE CHARACTERISTICS AND MAXIMUM RATINGS | | | | | | | |
| I_S | Maximum Continuous Drain-Source Diode Forward Current | | 2N7002 | | | 115 | mA |
| | | | NDS7002A | | | 280 | |
| I_{SM} | Maximum Pulsed Drain-Source Diode Forward Current | | 2N7002 | | | 0.8 | A |
| | | | NDS7002A | | | 1.5 | |
| V_{SD} | Drain-Source Diode Forward Voltage | $V_{GS} = 0\text{ V}, I_S = 115\text{ mA}$ (Note 1) | 2N7002 | | 0.88 | 1.5 | V |
| | | $V_{GS} = 0\text{ V}, I_S = 400\text{ mA}$ (Note 1) | NDS7002A | | 0.88 | 1.2 | |
| Note: 1. Pulse Test: Pulse Width $\leq 300\ \mu\text{s}$. Duty Cycle $\leq 2.0\%$. | | | | | | | |

Typical Electrical Characteristics

2N7000 / 2N7002 / NDS7002A

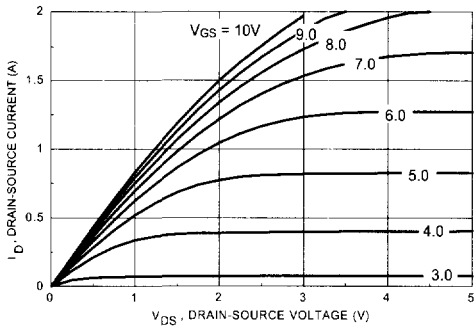

Figure 1. On-Region Characteristics.

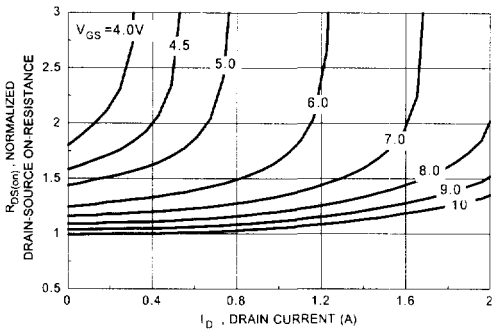

Figure 2. On-Resistance Variation with Gate Voltage and Drain Current

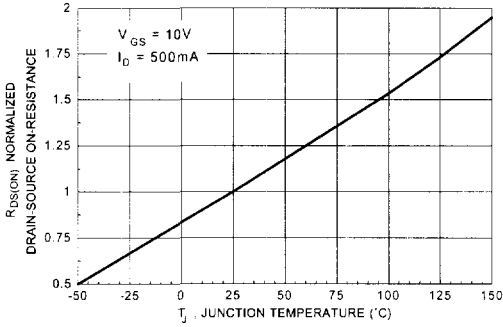

Figure 3. On-Resistance Variation with Temperature

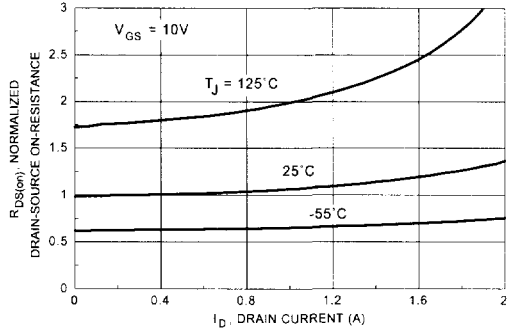

Figure 4. On-Resistance Variation with Drain Current and Temperature

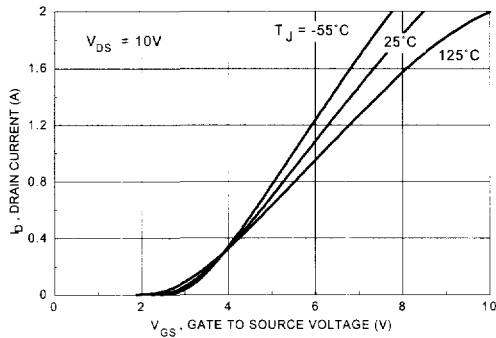

Figure 5. Transfer Characteristics.

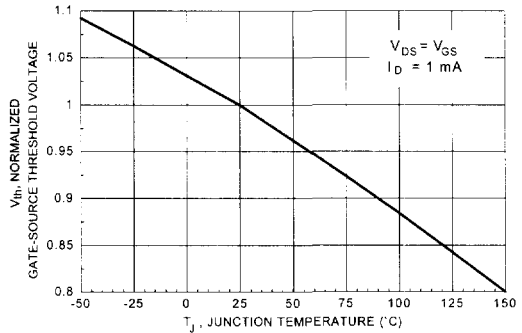

Figure 6. Gate Threshold Variation with Temperature.

Typical Electrical Characteristics (continued)

2N7000 / 2N7002 /NDS7002A

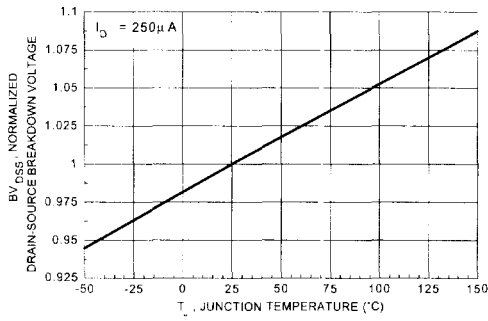

Figure 7. Breakdown Voltage Variation with Temperature.

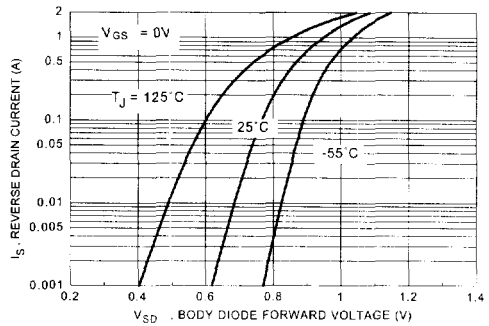

Figure 8. Body Diode Forward Voltage Variation with Current and Temperature.

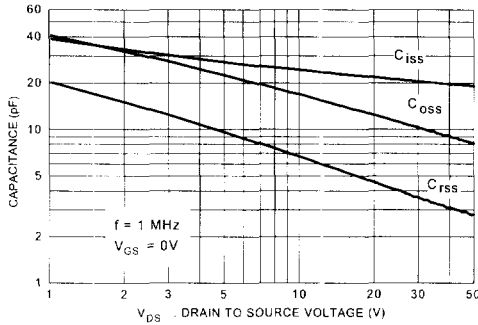

Figure 9. Capacitance Characteristics

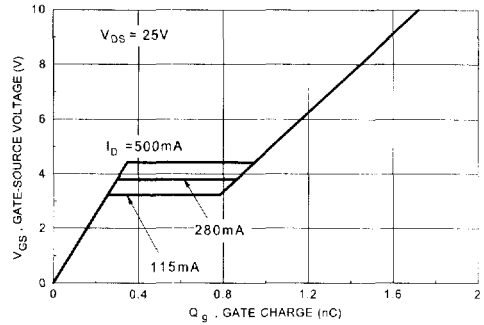

Figure 10. Gate Charge Characteristics.

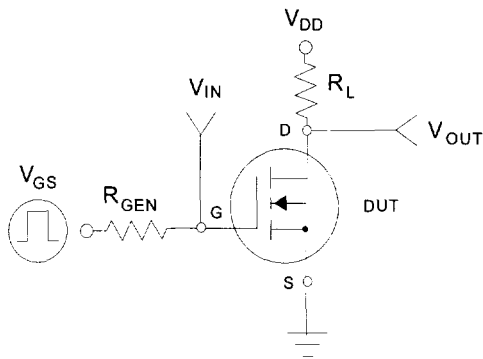

Figure 11. Switching Test Circuit.

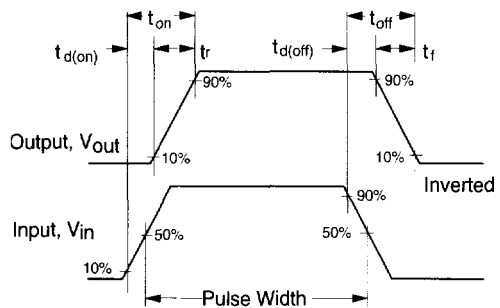

Figure 12. Switching Waveforms.

Typical Electrical Characteristics (continued)

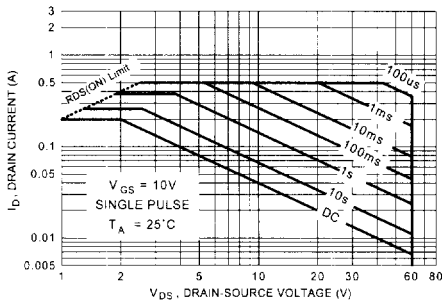

Figure 13. 2N7000 Maximum Safe Operating Area.

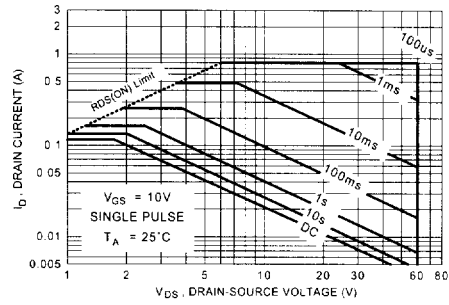

Figure 14. 2N7002 Maximum Safe Operating Area.

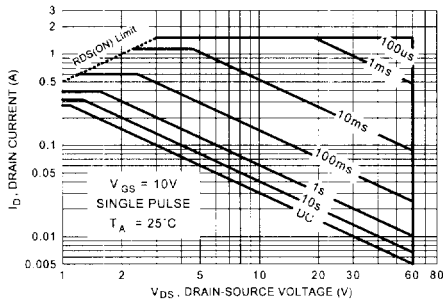

Figure 15. NDS7000A Maximum Safe Operating Area.

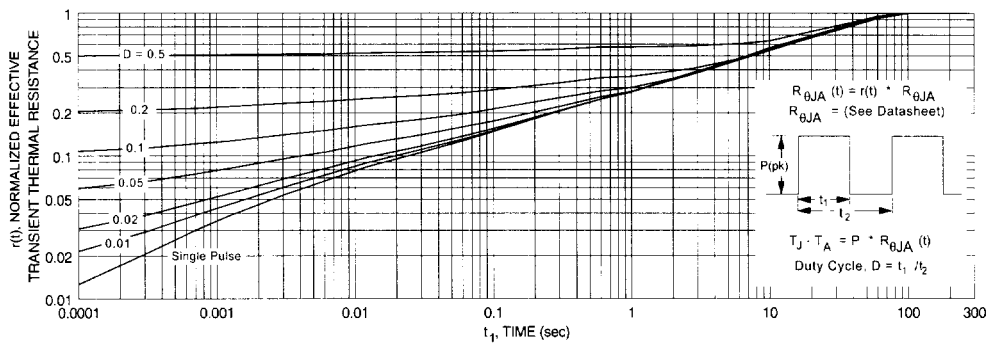

Figure 16. TO-92, 2N7000 Transient Thermal Response Curve.

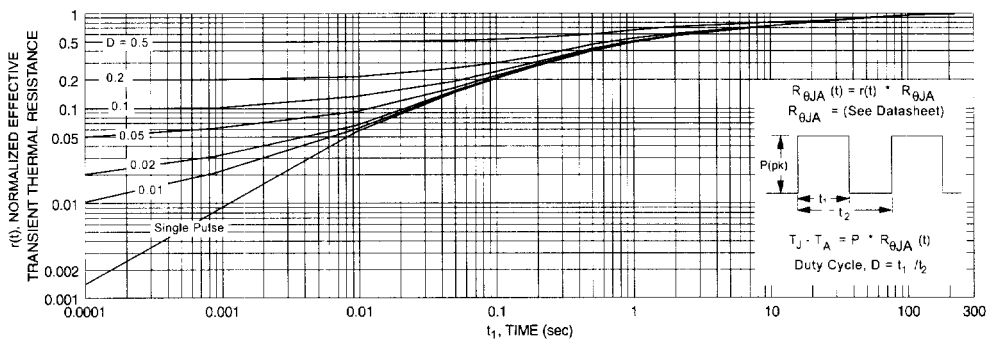

Figure 17. SOT-23, 2N7002 / NDS7002A Transient Thermal Response Curve.