

VCMB810 Common Mode Choke with Base

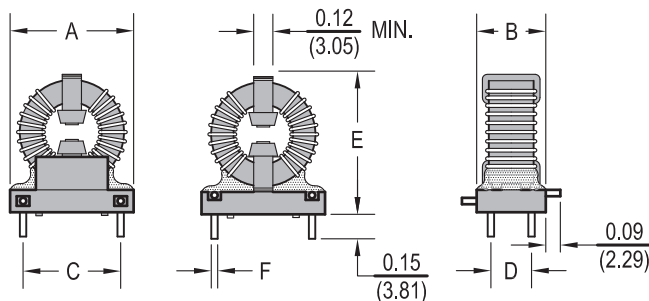

VCMB8101 - VCMB8103

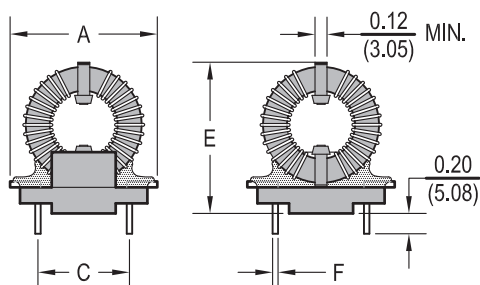
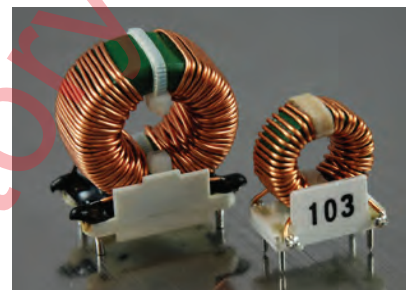
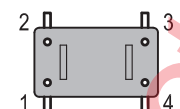
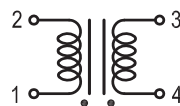

VCMB8104 - VCMB8121

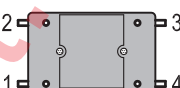
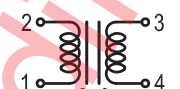

Features

- Solid Base for Stable Vertical Mounting
- Wide Range of Values and Current Ratings
- Excellent EMI Suppression
- Fixed Pins for easy PCB insertion

Electrical

Inductance Range: 1.0mH to 50mH

Tolerance: Inductance shown in min. L

Test Frequency: 1KHz

Operating Temp: -55°C ~ 105°C

Temp Rise: Idc based on a 35°C temp rise Typ.

Dielectric Strength: 1500Vrms

Base: VW-1 Flammability Rating

Allied Part Number	L(mH) Min @ 1KHZ	IDC (A)	DCR (Ω) Max.	Dim A Max Inch	Dim B±0.01 Inch	Dim C±0.015 Inch	Dim D±0.015 Inch	Dim E Max Inch	Dim F Max Inch
VCMB8101-RC	4	1.7	0.173	0.760	0.425	0.600	0.250	0.90	0.040
VCMB8102-RC	2.5	2.4	0.090	0.760	0.425	0.600	0.250	0.90	0.040
VCMB8103-RC	1	4.8	0.022	0.760	0.425	0.600	0.250	0.90	0.040
VCMB8104-RC	10	2.4	0.170	1.20	0.60	0.800	0.400	1.20	0.050
VCMB8105-RC	7	2.8	0.120	1.20	0.60	0.800	0.400	1.20	0.050
VCMB8106-RC	5	3.7	0.070	1.20	0.60	0.800	0.400	1.20	0.050
VCMB8107-RC	2	6.6	0.022	1.20	0.60	0.800	0.400	1.20	0.050
VCMB8108-RC	1	10	0.010	1.20	0.60	0.800	0.400	1.20	0.050
VCMB8109-RC	30	2.3	0.330	1.35	0.80	0.900	0.600	1.45	0.050
VCMB8110-RC	20	2.9	0.210	1.35	0.80	0.900	0.600	1.45	0.050
VCMB8111-RC	12	4.0	0.110	1.35	0.80	0.900	0.600	1.45	0.050
VCMB8112-RC	8	5.6	0.055	1.35	0.80	0.900	0.600	1.45	0.050
VCMB8113-RC	5	8.9	0.022	1.45	0.80	0.900	0.600	1.50	0.043
VCMB8114-RC	2.5	12.5	0.011	1.45	0.80	0.900	0.600	1.50	0.053
VCMB8115-RC	1.2	16.0	0.006	1.50	0.80	0.900	0.600	1.53	0.060
VCMB8116-RC	50	2.3	0.450	1.55	0.80	0.900	0.600	1.65	0.050
VCMB8117-RC	36	2.9	0.300	1.55	0.80	0.900	0.600	1.65	0.050
VCMB8118-RC	7.3	9.3	0.032	1.65	0.80	0.900	0.600	1.65	0.043
VCMB8119-RC	4	14.5	0.012	1.70	0.90	1.200	0.700	1.65	0.060
VCMB8120-RC	2.4	17	0.008	1.70	0.90	1.200	0.700	1.65	0.067
VCMB8121-RC	1	20	0.007	1.70	0.90	1.200	0.700	1.65	0.067

All specifications subject to change without notice.