



# MAX16927 Evaluation Kit

Evaluates: MAX16927

## General Description

The MAX16927 evaluation kit (EV kit) is a fully assembled and tested surface-mount circuit board that provides the voltages and features required for display systems in automotive applications. The EV kit contains a buck converter, boost converter, Cuk converter, positive gate-voltage linear regulator, negative gate-voltage linear-regulator controller, DAC-adjustable positive VCOM buffer, and DAC-adjustable negative VCOM buffer.

The EV kit operates from +6V to +16V or +3V to +5.5V DC supply voltage ranges. The EV kit's default input range is configured to +6V to +16V. The buck converter (VCC3) is configured for a +3.3V output providing at least 2A. The boost converter (VSH) is configured for a +7V output providing at least 200mA. The Cuk converter (VSL) is configured for a -7V output providing at least 100mA. The positive gate-voltage linear regulator (VGH) is configured for a +12V output providing at least 20mA. The negative gate-voltage linear-regulator controller (VGL) is configured for a -12V output providing at least 20mA. The negative VCOM buffer (VCOML) is DAC adjustable between -1V and +1V and can source or sink 10mA. The positive VCOM buffer (VCOMH) is DAC adjustable between +2.5V and +4.5V and can source or sink 100mA.

The EV kit provides an on-board USB interface circuit to communicate with the SPI™ interface circuits in the MAX16927 IC.

The EV kit also includes Windows® 2000-, Windows XP®, and Windows Vista®-compatible software that provides the user interface for exercising the features of the IC. The program is menu driven and offers a graphical user interface (GUI).

## Features

- ◆ +6V to +16V Single-Supply Operation
- ◆ +3V to +5.5V Single-Supply Operation
- ◆ Output Voltages
  - +3.3V Output at 2A (VCC3 Buck Converter)
  - +7V Output at 200mA (VSH Boost Converter)
  - 7V Output at 100mA (VSL Cuk Converter)
  - +12V Output at 20mA (VGH Positive Gate-Voltage Linear Regulator)
  - 12V Output at 20mA (VGL Negative Gate-Voltage Linear-Regulator Controller)
- ◆ DAC-Controlled VCOM Buffers
  - 1V to +1V DAC-Adjustable VCOML (±10mA), or
  - +2.5V to +4.5V DAC-Adjustable VCOMH (±100mA)
- ◆ 2.1MHz PWM Switching Frequency (Buck Converter)
- ◆ 1.2MHz PWM Switching Frequency (Boost and Cuk Converters)
- ◆ All Output Voltages are Resistor Adjustable (Except for the Buck Converter)
- ◆ On-Board USB Interface Circuit Generates SPI-Compatible Signals
- ◆ USB-PC Connection and Power (Cable Included)
- ◆ PCB Header for User-Supplied SPI-Compatible Signals
- ◆ Evaluates the MAX16927GTM/V+ in a 48-Pin TQFN (7mm x 7mm x 0.8mm) Package with an Exposed Pad
- ◆ Windows 2000-, Windows XP-, and Windows Vista (32-Bit)-Compatible Software
- ◆ Fully Assembled and Tested

## Ordering Information

PART	TYPE
MAX16927EVKIT+	EV Kit

+Denotes lead(Pb)-free and RoHS compliant.

SPI is a trademark of Motorola, Inc.

Windows, Windows XP, and Windows Vista are registered trademarks of Microsoft Corp.



# MAX16927 Evaluation Kit

Evaluates: MAX16927

## Component List

DESIGNATION	QTY	DESCRIPTION
C1, C4, C5, C22, C24	5	10 $\mu$ F $\pm$ 20%, 25V X7R ceramic capacitors (1210) Murata GRM32DR71E106M
C2, C3, C14, C17, C25, C27	6	0.1 $\mu$ F $\pm$ 10%, 50V X7R ceramic capacitors (0603) Murata GRM188R71H104K
C6, C12, C13, C16, C21, C29	6	1 $\mu$ F $\pm$ 10%, 25V X7R ceramic capacitors (0805) Murata GRM21BR71E105K
C7	1	4.7 $\mu$ F $\pm$ 20%, 50V X7R ceramic capacitor (1210) Murata GRM32ER71H475M
C8, C11	2	220pF $\pm$ 10%, 50V X7R ceramic capacitors (0603) Murata GRM188R71H221K
C9, C10	2	22pF $\pm$ 5%, 50V C0G ceramic capacitors (0805) Murata GRM2165C1H220J
C15	1	47 $\mu$ F $\pm$ 20%, 25V aluminum electrolytic capacitor (6.3mm x 6mm) SANYO 25CE47AX
C18, C19	2	22 $\mu$ F $\pm$ 20%, 25V X7R ceramic capacitors (1210) Murata GRM32ER71E226M
C20, C32	2	1 $\mu$ F $\pm$ 10%, 10V X7R ceramic capacitors (0603) Murata GRM188R71A105K
C23, C34	0	Not installed, ceramic capacitors (1210)
C26	1	4.7 $\mu$ F $\pm$ 20%, 25V X5R ceramic capacitor (1206) Murata GRM31CR71E475M
C30, C31, C33, C35, C36	0	Not installed, ceramic capacitors (0805)
C37, C38	0	Not installed, ceramic capacitors (1206)
C101, C103–C110, C117, C121	11	0.1 $\mu$ F $\pm$ 10%, 16V X7R ceramic capacitors (0603) Murata GRM188R71C104K

DESIGNATION	QTY	DESCRIPTION
C102, C113, C115	3	10 $\mu$ F $\pm$ 20%, 6.3V X5R ceramic capacitors (0805) Murata GRM21BR60J106M
C111, C112	2	10pF $\pm$ 5%, 50V C0G ceramic capacitors (0603) Murata GRM1885C1H100J
C114, C122–C127	7	1 $\mu$ F $\pm$ 10%, 10V X5R ceramic capacitors (0603) Murata GRM188R61A105K
C116	1	2.2 $\mu$ F $\pm$ 10%, 6.3V X5R ceramic capacitor (0603) Murata GRM188R60J225K
C118, C119	2	22pF $\pm$ 5%, 50V C0G ceramic capacitors (0603) Murata GRM1885C1H220J
C120	1	3300pF $\pm$ 10%, 50V X7R ceramic capacitor (0603) Murata GRM188R71H332K
D1, D2, D3	3	3A, 30V Schottky diodes (M-FLAT) Toshiba CMS02(TE12L,Q) (Top Mark: S2)
D4	1	2A, 50V fast-recovery diode (SMB) Fairchild ES2A
D5, D6	2	200mA, 100V dual diodes (SOT23) Fairchild MMBD4148SE (Top Mark: D4) Central Semi CMPD7000+ (Top Mark: C5C)
D7	1	Red SMT LED (0603)
D101	1	Green SMT LED (0603)
FB101	0	Not installed, ferrite bead—short (PC trace) (0603)
J1	1	12-pin header
JU1, JU2	2	2-pin headers
JU4–JU8, JU14–JU17	9	3-pin headers
JU9	1	4-pin, 3-way jumper
JU10–JU13	4	5-pin, 4-way jumpers
L1, L2	2	5.6 $\mu$ H, 2A inductors Sumida CDRH6D26-5R6NC

# MAX16927 Evaluation Kit

## Component List (continued)

DESIGNATION	QTY	DESCRIPTION
L3	1	3 $\mu$ H, 3A inductor Sumida CDRH6D28-3R0
L4	1	2.2 $\mu$ H, 9A inductor Würth 744314330
L5	0	Not installed, inductor—short (PC trace) (CDRH6D28)
N1	1	20V, 0.9A n-channel MOSFET (SOT23) Fairchild FDV305N (Top mark 305)
P1, P101	2	-20V, -2.4A p-channel MOSFETs (3 SuperSOT) Fairchild FDN304P_NL (Top Mark: 304)
Q1	1	nnp bipolar transistor (SOT23) Fairchild MMBT3904_NL (Top Mark: 1A)
R1, R10, R31	3	100k $\Omega$ $\pm$ 5% resistors (0603)
R2	1	100k $\Omega$ $\pm$ 1% resistor (0603)
R3	1	715k $\Omega$ $\pm$ 1% resistor (0603)
R4, R5	2	47k $\Omega$ $\pm$ 5% resistors (0603)
R6	1	110k $\Omega$ $\pm$ 1% resistor (0603)
R7	1	10k $\Omega$ $\pm$ 1% resistor (0603)
R8, R9, R16, R18, R19, R103	6	10k $\Omega$ $\pm$ 5% resistors (0603)
R11	1	71.5k $\Omega$ $\pm$ 1% resistor (0603)
R12	1	12.1k $\Omega$ $\pm$ 1% resistor (0603)
R13	1	6.8k $\Omega$ $\pm$ 5% resistor (0603)
R14	1	619k $\Omega$ $\pm$ 1% resistor (0603)
R15	1	51.1k $\Omega$ $\pm$ 1% resistor (0603)
R17	1	2k $\Omega$ $\pm$ 5% resistor (0603)
R21, R34	2	0 $\Omega$ $\pm$ 5% resistors (0805)
R22, R23, R26–R30, R35, R36	0	Not installed, resistors (0805)
R24	1	0 $\Omega$ $\pm$ 5% resistor (1206)
R25	0	Not installed, resistor—short (PC trace) (1206)
R32, R33	2	499k $\Omega$ $\pm$ 1% resistors (0603)

DESIGNATION	QTY	DESCRIPTION
R37, R101	2	0 $\Omega$ $\pm$ 5% resistors (0603)
R102	1	220 $\Omega$ $\pm$ 5% resistor (0603)
R104	1	2.2k $\Omega$ $\pm$ 5% resistor (0603)
R105	1	1.5k $\Omega$ $\pm$ 5% resistor (0603)
R106, R107	2	27 $\Omega$ $\pm$ 5% resistors (0603)
R108	1	1k $\Omega$ $\pm$ 5% resistor (0603)
U1	1	TFT-LCD power supply (48 TQFN-EP*) Maxim MAX16927GTM/V+
U101	1	32-bit microcontroller (68 QFN-EP*) Maxim MAXQ2000-RAX+
U102	1	EEPROM, 93C46-type 3-wire (8 SO)
U103	1	UART-to-USB converter (32 TQFP)
U104	1	3.3V, 300mA regulator (5 SOT23) Maxim MAX8888EZK33+ (Top Mark: ADQC)
U105	1	2.5V, 120mA regulator (5 SC70) Maxim MAX8511EXK25+ (Top Mark: ADV)
U106, U107, U108	3	Low-voltage level translators (10 $\mu$ MAX <sup>®</sup> ) Maxim MAX1840EUB+
USB	1	Type-B right-angle female USB connector
Y101	1	16MHz crystal Hong Kong X'tals SSM16000N1HK188F0-0
Y102	1	6MHz crystal Hong Kong X'tals SSL60000N1HK188F0-0
—	1	USB-A male to USB-B male cable, 6ft (beige)
—	16	Shunts
—	1	PCB: MAX16927 EVALUATION KIT+

\*EP = Exposed pad.

/V denotes an automotive qualified part.

$\mu$ MAX is a registered trademark of Maxim Integrated Products, Inc.

# MAX16927 Evaluation Kit

## Component Suppliers

SUPPLIER	PHONE	WEBSITE
Central Semiconductor Corp.	631-435-1110	www.centrasemi.com
Fairchild Semiconductor	888-522-5372	www.fairchildsemi.com
Hong Kong X'tals Ltd	852-35112388	www.hongkongcrystal.com
Murata Electronics North America, Inc.	770-436-1300	www.murata-northamerica.com
SANYO Electric Co., Ltd.	619-661-6835	www.sanyo.com
Sumida Corp.	847-545-6700	www.sumida.com
Toshiba America Electronic Components, Inc.	949-623-2900	www.toshiba.com/taec
Würth Elektronik GmbH & Co. KG	201-785-8800	www.we-online.com

**Note:** Indicate that you are using the MAX16927 when contacting these component suppliers.

## MAX16927 EV Kit Files

FILE	DESCRIPTION
INSTALL.EXE	Installs the EV kit files on the computer
MAX16927.EXE	Application program
FTD2XX.INF	USB driver file
UNINST.INI	Uninstalls the EV kit software
USB_Driver_Help.PDF	USB driver installation help file

### Quick Start

#### Required Equipment

- MAX16927 EV kit (USB cable included)
- User-supplied Windows 2000, Windows XP, or Windows Vista PC with a spare USB port
- +6V to +16V, 1A DC power supply
- Voltmeter

**Note:** In the following sections, software-related items are identified by bolding. Text in **bold** refers to items directly from the EV kit software. Text in **bold and underlined** refers to items from the Windows operating system. The test procedure assumes that Windows XP SP2 is being used. Similar steps are required for the other supported operating systems.

#### Procedure

The EV kit is fully assembled and tested. Follow the steps below to verify board operation. **Caution: Do not turn on the power supply until all connections are completed.**

- 1) Visit [www.maxim-ic.com/evkitsoftware](http://www.maxim-ic.com/evkitsoftware) to download the latest version of the EV kit software, 16927Rxx.ZIP. Save the EV kit software to a temporary folder and uncompress the ZIP files.
- 2) Install the EV kit software on the computer by running the INSTALL.EXE program inside the temporary folder. The program files are copied and icons are created in the Windows **Start | Programs** menu.
- 3) Verify that shunts are installed in their default positions, as shown in Table 1.
- 4) Turn on the power supply and set it to +6V; disable the power supply.
- 5) Connect the positive terminal of the power supply to the IN3 pad on the EV kit. Connect the negative terminal of the power supply to the PGND3 pad.
- 6) Connect the USB cable from the PC to the EV kit board. A **New Hardware Found** window pops up when installing the USB driver for the first time. If a window is not seen that is similar to the one described above after 30s, remove the USB cable from the board and reconnect it. Administrator privileges are required to install the USB device driver on Windows.
- 7) Follow the directions of the **Found New Hardware** window to install the USB device driver. Manually specify the location of the device driver to be **C:\Program Files\MAX16927** (default installation directory) using the **Browse** button. During device driver installation, Windows may show a warning

# MAX16927 Evaluation Kit

Evaluates: MAX16927

message indicating that the device driver Maxim uses does not contain a digital signature. This is not an error condition and it is safe to proceed with installation. Refer to the USB\_Driver\_Help.PDF document included with the software for additional information.

- 8) Enable the power supply.
- 9) Start the EV kit software by opening its icon in the **Start | Programs** menu.
- 10) Observe as the program automatically detects the connection of the device and starts the main program. After successful connection, the EV kit software main window appears in the upper-left corner of the window, as shown in Figure 1.
- 11) Select **Enabled** in the **+3.3V (EN3)** radio group box. This enables the buck (+6V to +16V to +3.3V) DCDC.
- 12) Verify that the VCC3 buck-converter output (VCC3) is +3.3V.
- 13) Select **Enabled** in the **Input Pwr (ENP)** radio group box.
- 14) Select **Seq 0: SPI determines which regulator is on** in the **Power Sequencing (EN2, EN1)** radio group box.
- 15) Select **Enabled** in the **VSH** radio group box.
- 16) Verify that the VSH boost-converter output (VSH) is +7V.
- 17) Select **Enabled** in the **VSL** radio group box.
- 18) Verify that the VSL Cuk converter output (VSL) is -7V.
- 19) Select **Enabled** in the **VSLs** radio group box.
- 20) Verify that the VSLs sequenced Cuk converter output (VSLs) is -7V.
- 21) Select **Enabled** in the **VGH** radio group box.
- 22) Verify that the VGH positive gate-voltage linear-regulator output (VGH) is +12V.
- 23) Select **Enabled** in the **VGL** radio group box.
- 24) Verify that the VGL negative gate-voltage linear-regulator controller output (VGL) is -12V.
- 25) Select **Positive** in the **DAC Direction** radio group box.
- 26) Enter **7F** into the **DAC Value** edit box.
- 27) Verify that the VCOML buffer output (VCOML) is +1V.
- 28) The EV kit is now ready for additional testing.

**Table 1. Default Shunt Positions**

JUMPER	SHUNT POSITION	PIN CONNECTION	EV KIT FUNCTION
JU1	Not installed	PGOOD not connected to ENP	ENP controlled by JU10
JU2	Installed	$\overline{FLT}$ to LLT_ $\overline{FLT}$	J1-6 and the on-board SPI interface circuit (LED indication is active)
JU4	1-2	LXN to R21	Charge pumps powered by LXN
JU5	1-2	VSL to D6, pin 2	Negative charge pump refers to VSL
JU6	2-3	FBN to R2/R3 divider	FBN receives feedback from VSL through R2/R3 divider
JU7	1-2	VCOMN to VSL	VCOMN is powered by VSL
JU8	1-2	SYNC to AVL	DCDC3 skip mode enabled under light load
JU9	1-2	SSEN to INA	Spread spectrum enabled
JU10	1-2	ENP to LLT_ENP	On-board SPI interface controls ENP
JU11	1-2	EN1 to LLT_EN1	On-board SPI interface controls EN1
JU12	1-2	EN2 to LLT_EN2	On-board SPI interface controls EN2
JU13	1-2	EN3 to LLT_EN3	On-board SPI interface controls EN3
JU14	2-3	$\overline{CS}$ to LLT_ $\overline{CS}$	On-board SPI interface controls $\overline{CS}$
JU15	2-3	CLK to LLT_CLK	On-board SPI interface controls CLK
JU16	2-3	DIN to MAXQ_DOUT	On-board SPI interface controls DIN
JU17	2-3	DOUT to LLT_DIN	On-board SPI interface controls DOUT

# MAX16927 Evaluation Kit

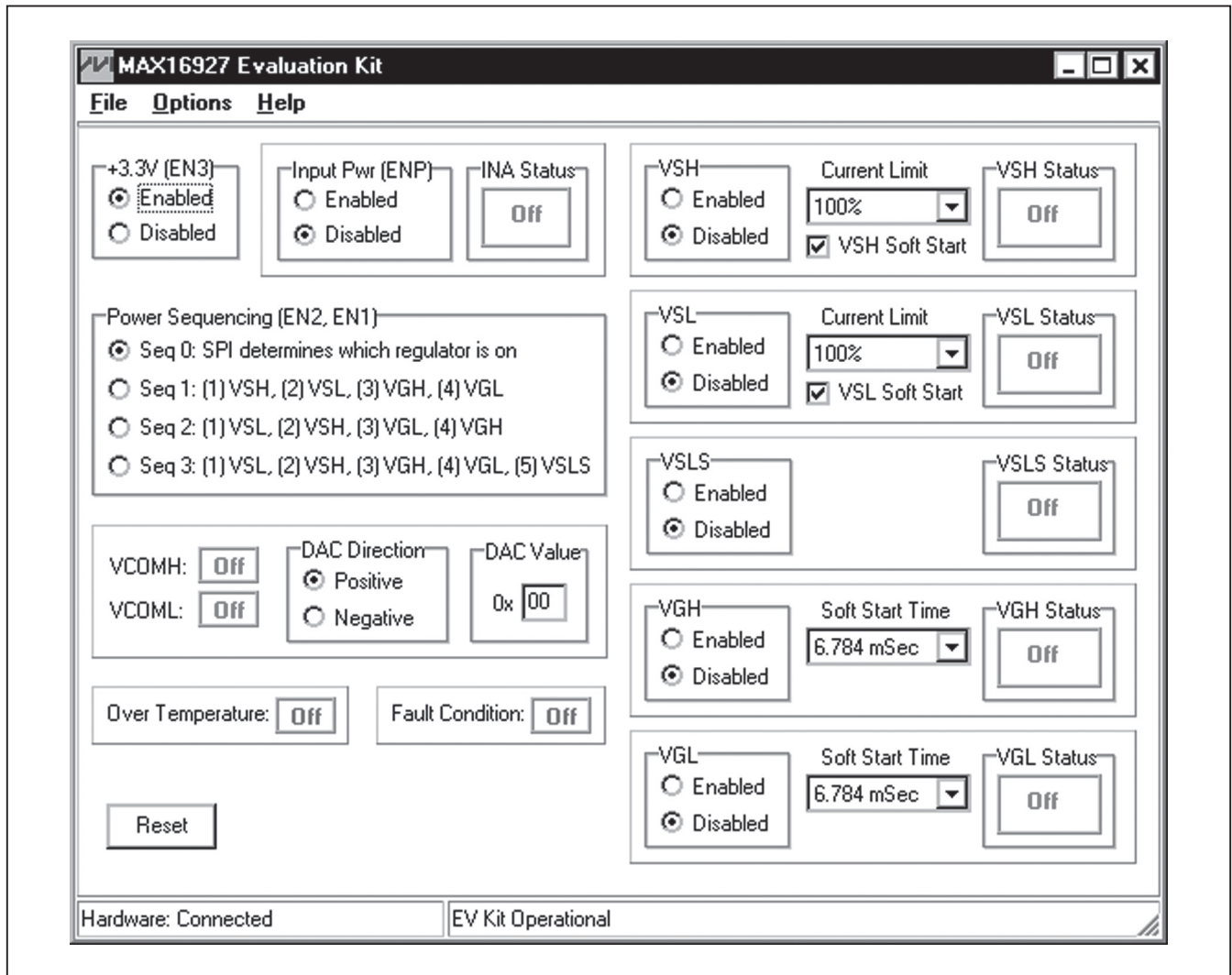

Figure 1. MAX16927 EV Kit Software Main Window

# MAX16927 Evaluation Kit

Evaluates: MAX16927

## Detailed Description of Software

**Note:** Text in **bold** indicates user-selectable features in the MAX16927 EV kit software.

### Graphic User Interface (GUI) Panel

The GUI shown in Figure 1 displays the EV kit software main window. This window provides a convenient means to control the device. Use the mouse or press the Tab key to navigate through the GUI controls. The correct SPI write operation is generated to update the device's internal memory registers when any of these controls are executed.

The EV kit software main window (Figure 1) divides the EV kit software functions into logical sections: The **+3.3V (EN3)** and **Input Pwr (ENP)** sections, the **Power Sequencing (EN2, EN1)** section, the **VSH, VSL, VSLS, VGL,** and **VGH** sections, the **VCOMH** and **VCOML** sections, and the **Over Temperature** and **Fault Condition** displays. **+3.3V (EN3)** enables or disables the +3.3V buck converter. **Input Pwr (ENP)** enables or disables all the outputs on the EV kit, except for the buck-converter output. **Power Sequencing (EN2, EN1)** selects the power-on sequence. **VSH, VSL, VSLS, VGL,** and **VGH** control the VSH, VSL, VSLS, VGL, and VGH, respectively. **VCOMH** and **VCOML** control the VCOMH or VCOML directions and outputs.

The bottom-left status bar on the main window provides the USB interface circuit connectivity status. The bottom-right status bar indicates the EV kit operational status.

### Software Startup

Upon startup of the program, the EV kit software automatically searches for the USB interface circuit connection. The EV kit enters the normal operating mode when the USB connection is detected. The **+3.3V (EN3)** is **Enabled** and the **Input Pwr (ENP)** and **VSH, VSL, VSLS, VGL,** and **VGH** are **Disabled**. The **Power Sequencing (EN2, EN1)** is set to **Seq 0: SPI determines which regulator is on**. The **VCOMH** and **VCOML** are **Off**. The **DAC Direction** is set to **Positive**. The **DAC Value** is set to **00**. Both the **Over Temperature** and the **Fault**

**Condition** display **Off**. The bottom-left status bar indicates **Hardware: Connected**, and the bottom-right status bar indicates **EV Kit Operational**. If the USB connection is not detected, the software prompts the user to retry, exit the program, or enter the demo mode.

### Demo Mode

The EV kit software can enter the demo mode when the USB connection is not detected, by selecting **Cancel** on the EV kit **Software Interface Circuit** pop-up window (Figure 2). The software can also enter the demo mode at any time by selecting the **Options | Demo Mode** menu item in the main window. When in demo mode, all software communication to the EV kit circuit is disabled; however, most of the software GUI is functional. Demo mode allows the user to evaluate the software without hardware connectivity. To exit demo mode, select the **Options | Demo Mode** menu item.

### +3.3V (EN3)

The **+3.3V (EN3)** radio group box enables or disables the buck converter. When **+3.3V (EN3)** is **Enabled**, VCC3 is **On** and all 32 bits in the register are set low. When **+3.3V (EN3)** is **Disabled**, VCC3 is **Off** and all 32 bits in the register are set high.

### Input Pwr (ENP)

The **Input Pwr (ENP)** radio group box enables or disables the device except for the buck converter. When **+3.3V (EN3)** and **Input Pwr (ENP)** are **Enabled**, VSH, VSL, VSLS, VGL, and VGH are controlled by their respective **Enabled/Disabled** commands. When **Input Pwr (ENP)** is **Disabled**, VSH, VSL, VSLS, VGL, and VGH are **Off**, regardless of their respective **Enabled/Disabled** commands.

### Power Sequencing (EN2, EN1)

The **Power Sequencing (EN2, EN1)** radio group box selects the EV kit power sequence. When the **Seq 0: SPI determines which regulator is on** is selected, the SPI interface determines which regulator is on or off. When **Seq 1: (1) VSH, (2) VSL, (3) VGH, (4) VGL** is selected, VSH, VSL, VGH, and VGL are powered in the sequence

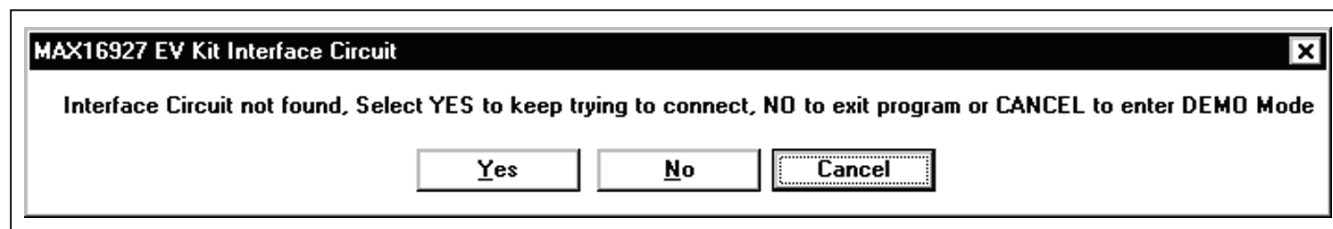

Figure 2. MAX16927 EV Kit Software Interface Circuit Pop-Up Window

# MAX16927 Evaluation Kit

stated by the number inside their respective preceding parentheses, and likewise for **Seq 2** and **Seq 3**.

## **VCOMH, VCOML, DAC Direction, DAC Value**

The EV kit software features a panel that contains the **VCOMH** and **VCOML** status displays, the **DAC Direction** radio group box, and the **DAC Value** edit box. The **VCOMH** and **VCOML** status boxes display the **VCOMH** and **VCOML** **On/Off** states. The **DAC Direction** radio group box selects the DAC's **Positive** or **Negative** direction. The **DAC Value** edit box accepts a hex number between **00** and **7F** to scale the **VCOMH** or **VCOML** values. The **VCOML** values are scaled to between 0 and +1V when the **DAC Direction** is **Positive**, or between 0 and -1V when the **DAC Direction** is **Negative**.

## **Over Temperature**

The EV kit software features a panel that displays the device's overtemperature condition. The **Over Temperature** panel displays **On** when the device's internal die temperature exceeds +165°C (typ).

## **Fault Condition**

The EV kit software features a panel that displays the device's fault condition. The **Fault Condition** panel displays **On** when one or more of the device's output voltages (except for the buck-converter output) is less than 85% of their regulated values.

## **Reset**

The **Reset** button resets the EV kit to the following condition: **+3.3V (EN3) = Disabled**, **Input Pwr (ENP) = Disabled**, **Power Sequence (EN2, EN1) = Seq 0**; **SPI determines which regulator is on**, **DAC Direction = Positive**, **DAC Value = 00**, **VSH = Disabled**, **VSH Current Limit = 100%**, **VSH Soft Start = checked**, **VSL = Disabled**, **VSL Current Limit = 100%**, **VSL Soft Start = checked**, **VSLS = Disabled**, **VGH = Disabled**, **VGH Soft Start Time = 6.784 mSec**, **VGL = Disabled**, and **VGL Soft Start Time = 6.784 mSec**.

## **VSH Enabled/Disabled, Current Limit, VSH Soft-Start, and VSH Status**

The EV kit software features a panel that includes the **VSH Enabled/Disabled** radio buttons, the **Current Limit** drop-down list, the **VSH Soft Start** checkbox, and the **VSH Status** display. The **VSH Enabled/Disabled** radio buttons enable or disable the VSH regulator. Enable the **+3.3V (EN3)** and **Input Pwr (ENP)** before enabling **VSH**. The **Current Limit** drop-down list selects the VSH current limit. The **VSH Soft Start** checkbox enables or

disables the VSH soft-start feature. **VSH Status** displays the VSH **On/Off** status.

## **VSL Enabled/Disabled, Current Limit, VSL Soft-Start, and VSL Status**

The EV kit software features a panel that includes the **VSL Enabled/Disabled** radio buttons, the **Current Limit** drop-down list, the **VSL Soft Start** checkbox, and the **VSL Status** display. The **VSL Enabled/Disabled** radio buttons enable or disable the VSL regulator. Enable the **+3.3V (EN3)** and **Input Pwr (ENP)** before enabling **VSL**. The **Current Limit** drop-down list selects the VSL current limit. The **VSL Soft Start** check box enables or disables the VSL soft-start feature. **VSL Status** displays the VSL **On/Off** status.

## **VSLS Enabled/Disabled and VSLS Status**

The EV kit software features a panel that includes the **VSLS Enabled/Disabled** radio buttons and the **VSLS Status** display. The **VSLS Enabled/Disable** radio buttons enable or disable the VSLS switch. Enable the **+3.3V (EN3)**, **Input Pwr (ENP)**, and **VSL** before enabling **VSLS**. **VSLS Status** displays the VSLS **On/Off** status.

## **VGH Enabled/Disabled, Soft-Start Time, and VGH Status**

The EV kit software features a panel that includes the **VGH Enabled/Disabled** radio buttons, the **Soft Start Time** drop-down list, and the **VGH Status** display. The **VGH Enabled/Disabled** radio buttons enable or disable the VGH regulator. Enable the **+3.3V (EN3)**, **Input Pwr (ENP)**, **VSH**, and **VSL** before enabling **VGH**. The **Soft Start Time** drop-down list selects the VGH soft-start time. **VGH Status** displays the VGH **On/Off** status.

## **VGL Enabled/Disabled, Soft-Start Time, and VGL Status**

The EV kit software features a panel that includes the **VGL Enabled/Disabled** radio buttons, the **Soft Start Time** drop-down list, and the **VGL Status** display. The **VGL Enabled/Disabled** radio buttons enable or disable the VGL regulator. Enable the **+3.3V (EN3)**, **Input Pwr (ENP)**, **VSH**, and **VSL** before enabling **VGL**. The **Soft Start Time** drop-down list selects the VGL soft-start time. **VGL Status** displays the VGL **On/Off** status.

## **Keyboard Navigation**

Press the Tab key to select each GUI control. Most of the selected control is indicated by a dotted outline. Using Shift + Tab moves the selection to the previously selected control. Buttons respond to the keyboard's space bar. Some controls respond to the keyboard's up-and-down arrow keys. Activate the program's menu bar by press-



# MAX16927 Evaluation Kit

Evaluates: MAX16927

ing the F10 key, then press the letter of the desired menu item. When the Alt key is pressed and released, most menu items show one letter underlined, indicating their shortcut key.

## General Troubleshooting

**Problem: software reports it cannot find the interface circuit.**

- Is the interface circuit power LED lit?
- Is the USB cable connected?
- Has Windows plug-and-play detected the board? Bring up Control Panel → System → Device Manager, and look at what device nodes are indicated for USB. If there is an “unknown device” node attached to the USB, delete it; this forces plug-and-play to try again.
- Are jumpers JU10–JU17 properly configured?

## Detailed Description of Hardware

The MAX16927 EV kit contains a buck converter for the VCC3 supply, boost converter for the VSH supply, Cuk converter for the VSL supply, single-stage positive charge-pump for the positive gate-voltage linear-regulator supply (VGH), single-stage negative charge pump for the negative gate-voltage linear-regulator controller supply (VGL), DAC-adjustable positive VCOM buffer (VCOMH), and DAC-adjustable negative VCOM buffer (VCOML).

### Input Power Supply

The EV kit operates from +6V to +16V or +3V to +5.5V DC supply voltage ranges. When operating the EV kit from a +6V to +16V power supply, connect the power supply between the IN3 and PGND3 PCB pads. When operating the EV kit from a +3V to +5.5V power supply, connect the power supply between the VCC3 and PGND3 PCB pads. Refer to the *Detailed Description* section in the MAX16927 IC data sheet for additional information. The EV kit's default input range is configured to +6V to +16V.

### VCC3, PGOOD, and AVL (Buck Converter)

The VCC3 buck converter is configured for a +3.3V output providing at least 2A. The VCC3 buck converter switches at 2.1MHz in a default spread-spectrum mode. The VCC3 buck-converter output is available between the VCC3 and AGND3 PCB pads.

The EV kit provides a PGOOD PCB pad that indicates the buck-converter output status. PGOOD is an active-high output that pulls low when the buck output voltage is below 90% of its nominal value and pulls high when the output voltage is above 92% of its nominal value.

The EV kit provides an AVL PCB pad to verify the buck converter's 5V bias voltage.

### VSH (Boost Converter)

The VSH boost converter is configured for a +7V output providing at least 200mA. The VSH boost-converter output voltage can be adjusted from INA to +18V by replacing feedback resistors R11 and R12 (refer to the *Boost Converter* section in the MAX16927 IC data sheet). Operation at significantly higher output voltages can reduce the available output current and require changes in component values or component voltage rating.

### VSL (Cuk Converter)

The VSL inverted switching regulator is configured for a -7V output providing at least 100mA. The VSL inverted switching-regulator output voltage can be adjusted from -4V to -7V by replacing feedback resistors R2 and R3. If the Cuk converter output is set more negative than -7V, VSL must be disconnected from the VCOMN (refer to the *Cuk Converter* section in the MAX16927 IC data sheet). Operation at higher negative output voltages can reduce the available output current.

### VSLS (Sequenced VSL Output)

The VSLS output is a sequenced VSL. The VSLS output is controlled by an external n-channel MOSFET (switch). This switch is controlled by the SPI command available at the device's VSLS pin. When the VSLS switch is on, the VSLS PCB pad is connected to the VSL PCB pad through the n-channel MOSFET, allowing VSLS to share the voltage and current with the VSL output for sequencing.

### VGH, VCP (Positive Gate-Voltage Linear Regulator/Charge Pump)

The VGH positive gate-voltage regulator is configured for a +12V output providing at least 20mA. The VGH positive gate-voltage regulator receives power from the VCP. VCP is a single-stage, positive charge pump. The VGH positive gate-voltage regulator's output voltage can be adjusted from +4.5V to +16V by replacing feedback resistors R6 and R7 (refer to the *Positive Gate-Voltage Linear Regulator (VGH)* section in the MAX16927 IC data sheet).

## MAX16927 Evaluation Kit

### **VGL, VCN (Negative Gate-Voltage Linear-Regulator Controller/Charge Pump)**

The VGL negative gate-voltage regulator is configured for a -12V output providing at least 20mA. The VGL negative gate-voltage regulator receives power from the VCN. VCN is a single-stage, negative charge pump. The VGL negative gate-voltage regulator's output voltage can be adjusted from -4.5V to -16V by replacing feedback resistors R14 and R15 (refer to the *Negative Gate-Voltage Linear-Regulator Controller (VGL)* section in the MAX16927 IC data sheet). Note that a short circuit at VGL can destroy the external npn transistor on the EV kit.

### **VCOMN, VCINL, VCOML (Negative VCOM Buffer)**

The EV kit provides the VCOMN, VCINL, and VCOML PCB pads to access the negative VCOM buffer. The VCOMN PCB pad accepts the power supply to the negative VCOM buffer. The VCINL PCB pad accepts an offset voltage to the negative VCOM DAC output. The VCOML is the negative VCOM buffer output. The negative VCOM buffer output (VCOML) is DAC adjustable between -1V and +1V and can source or sink 10mA.

The EV kit can only activate VCOML or VCOMH, but not both. The EV kit is configured with the VCOML active and VCOMH inactive by default. To activate VCOMH on the EV kit, see the *VCOMP, VCINH, and VCOMH (Positive VCOM Buffer)* section.

### **VCOMP, VCINH, VCOMH (Positive VCOM Buffer)**

The EV kit provides the VCOMP, VCINH, and VCOMH PCB pads to access the positive VCOM buffer. The VCOMP PCB pad accepts the power supply to the positive VCOM buffer. The VCINH PCB pad accepts an offset voltage to the positive VCOM DAC output. The VCOMH is the positive VCOM buffer output. The positive VCOM buffer output (VCOMH) is DAC adjustable between +2.5V and +4.5V and can source or sink 100mA.

VCINH features an internal voltage-divider that sets VCOMH to VCOMP/2 voltage. This voltage is DAC adjustable by  $\pm 1V$  ( $VSH/2 \pm 1V$ ). Also, the basic voltage VCOMP/2 can be overwritten by driving VCINH (this range is +2V to (VCOMP - 2V).

The EV kit can only activate VCOML or VCOMH, but not both. The EV kit is configured with the VCOML active and VCOMH inactive by default. To activate VCOMH on the EV kit, follow the steps below:

- 1) Install a shunt on pins 2-3 of jumper JU4 (charge pump's source from LXP).
- 2) Install a shunt on pins 2-3 of jumper JU5 (VCN discharge to GNDP).
- 3) Install a shunt on pins 1-2 of jumper JU6 (VCOMH on, VCOML off).
- 4) Replace resistor R14 with a lower value (R14 value is application dependent; refer to the *Negative Gate-Voltage Linear-Regulator Controller (VGL)* section in the MAX16927 IC data sheet for additional information).

# MAX16927 Evaluation Kit

Evaluates: MAX16927

## Jumper Selection

### Primary Enable (ENP)

Jumpers JU1 and JU10 enable or disable the device, except for the buck converter. See Table 2 for shunt positions.

### Fault Output ( $\overline{FLT}$ )

Jumper JU2 selects the destination for the fault output signal from the  $\overline{FLT}$  pin. See Table 3 for shunt positions.

### Charge-Pump Input Source (LXN, LXP) and VCN Discharging Level (VSL, GNDCP)

Jumper JU4 selects the charge-pump input source. This input source determines the charge-pump output voltages (VCP, VCN). In addition, jumper JU5 selects the negative charge-pump VCN discharging level. This discharging level further controls the VCN magnitude. See Table 4 for shunt positions.

**Note:** If the CUK converter is not operated, JU4 must be set to the 2-3 position; JU5 is not used.

**Table 2. JU1, JU10 Jumper Selection (ENP)**

SHUNT POSITION		ENP PIN CONNECTED TO	EV KIT OUTPUTS (NOT INCLUDING THE BUCK CONVERTER)
JU1	JU10		
Installed	Not installed	PGOOD (U1, pin 14)	ENP follows status of buck PGOOD (i.e., if buck is running, it activates the ENP automatically)
Not installed*	1-2*	U107, pin 8	On-board SPI controlled
Not installed	1-3	INA (through resistor R16)	Enabled
Not installed	1-4	J1-8	External logic controlled
Not installed	1-5	AGND	Disabled
Not installed	Not installed	Pulldown	Disabled

\*Default position.

**Table 3. JU2 Jumper Selection ( $\overline{FLT}$ )**

SHUNT POSITION	$\overline{FLT}$ PIN CONNECTED TO	$\overline{FLT}$ PIN OUTPUTS SIGNALS TO
Installed*	J1-6 and U108, pin 10	J1-6 and the on-board SPI interface circuit (LED indication active)
Not installed	J1-6	J1-6

\*Default position.

**Table 4. JU4 and JU5 Jumper Selection (VCP, VCN)**

SHUNT POSITION		VCN DISCHARGES TO	CHARGE-PUMP OUTPUT VOLTAGES
JU4	JU5		
1-2* (C2 and C3 connected to LXN)	1-2*	VSL	VCP = +16.6V VCN = -16.6V
	2-3	GNDCP	VCP = +16.6V VCN = -9.8V
2-3 (C2 and C3 connected to LXP)	1-2	VSL	VCP = +13.3V VCN = -13.3V
	2-3	GNDCP	VCP = +13.3V VCN = -6.5V

\*Default position.

# MAX16927 Evaluation Kit

## Cuk Converter Feedback (FBN)

The Cuk converter feedback FBN pin has two functions. The FBN can be used to regulate the Cuk converter output. It can be used to configure the boost convert for a higher power output, and to select whether VCOMH or VCOML is enabled. Refer to the MAX16927 IC data sheet for more advanced features and operations. Jumper JU6 selects the device's Cuk converter's feedback input. See Table 5 for shunt positions.

## Negative VCOM Buffer Supply (VCOMN)

Jumper JU7 selects the device's negative VCOM Buffer supply. See Table 6 for shunt positions.

## Buck-Converter Sync Input (SYNC)

Jumper JU8 selects the device's buck-converter sync input. See Table 7 for shunt positions.

## Spread-Spectrum Enable (SSEN)

Jumper JU9 enables or disables the device's spread-spectrum mode for the boost and Cuk converters. See Table 8 for shunt positions.

**Table 5. JU6 Jumper Selection (FBN)**

SHUNT POSITION	FBN PIN CONNECTED TO	CUK CONVERTER OUTPUT (VSL) REGULATED TO
1-2	INA	<ul style="list-style-type: none"> <li>Not regulated (Cuk converter off)</li> <li>Install a 0Ω resistor to R35 to configure the VSH output to +18V at 200mA</li> <li>VCOMH active and VCOML inactive</li> </ul>
2-3*	VSL (through voltage dividing-resistors R2 and R3)	<ul style="list-style-type: none"> <li>-7V (if the Cuk converter is set more negative than -7V, VSL must be disconnected from the VCOMN)</li> <li>VCOML active and VCOMH inactive</li> </ul>
Not installed	Not connected	Not regulated

\*Default position.

**Table 6. JU7 Jumper Selection (VCOMN)**

SHUNT POSITION	VCOMN PIN CONNECTED TO	NEGATIVE VCOM BUFFER SUPPLIED BY
1-2*	VSL	VSL
2-3	VCGND	Not powered
Not installed	Not connected	Not powered

\*Default position.

**Table 8. JU9 Jumper Selection (SSEN)**

SHUNT POSITION	SSEN PIN CONNECTED TO	BOOST AND CUK CONVERTERS SPREAD-SPECTRUM MODE
1-2*	INA	Enabled
1-3	J1-7	External logic controlled
1-4	AGND	Fixed 1.2MHz switching frequency
Not installed	Internal pulldown	Fixed 1.2MHz switching frequency

\*Default position.

**Table 7. JU8 Jumper Selection (SYNC)**

SHUNT POSITION	SYNC PIN CONNECTED TO	BUCK-CONVERTER OPERATING MODE OR SYNCHRONIZATION
1-2*	AVL	DCDC3 skip mode enabled under light load
2-3	J1-12	DCDC3 synchronized to externally provided clock signal

\*Default position.

# MAX16927 Evaluation Kit

Evaluates: MAX16927

## Output Sequencing (EN1, EN2)

Jumpers JU11 and JU12 select the device's output sequencing for the VSH, VSL, VSLS, VGH, and VGL. See Table 9 for shunt positions.

## Buck-Converter Enable (EN3)

Jumper JU13 enables or disables the device's buck converter. See Table 10 for shunt positions.

## SPI Chip Select ( $\overline{CS}$ )

Jumper JU14 selects the device's SPI chip-select controlling source. See Table 11 for shunt positions.

## SPI Clock (CLK)

Jumper JU15 selects the device's SPI clock source. See Table 12 for shunt positions.

**Table 9. JU11, JU12 Jumper Selection (EN1, EN2)**

SHUNT POSITION		VSH, VSL, VSLS, VGH, AND VGL OUTPUT SEQUENCING
JU11 (EN1)	JU12 (EN2)	
1-2*	1-2*	On-board SPI controlled
1-4	1-4	External logic controlled; Connect EN1 to J1-9; Connect EN2 to J1-10
1-5	1-5	Seq 0: SPI determines which regulator is on
	1-3	Seq 1: (1) VSH, (2) VSL, (3) VGH, (4) VGL
1-3	1-5	Seq 2: (1) VSL, (2) VSH, (3) VGL, (4) VGH
	1-3	Seq 3: (1) VSL, (2) VSH, (3) VGH, (4) VGL, (5) VSLS

\*Default position.

**Table 10. JU13 Jumper Selection (EN3)**

SHUNT POSITION	EN3 PIN CONNECTED TO	BUCK-CONVERTER OUTPUT
1-2*	U101, pin 63	On-board SPI controlled
1-3	IN3 (through resistor R8)	Enabled
1-4	J1-11	External logic controlled
1-5	AGND3	Disabled
Not installed	Not allowed	Not allowed

\*Default position.

## SPI Data Input (DIN)

Jumper JU16 selects the device's SPI data-input source. See Table 13 for shunt positions.

## SPI Data Output (DOUT)

Jumper JU17 selects the device's SPI data-out destination. See Table 14 for shunt positions.

**Table 11. JU14 Jumper Selection ( $\overline{CS}$ )**

SHUNT POSITION	$\overline{CS}$ PIN CONNECTED TO	SPI CHIP SELECT CONTROLLED BY
1-2	J1-1	External SPI controller
2-3*	U106, pin 8	On-board SPI controller
Not installed	Internal pullup	No controlling source

\*Default position.

**Table 12. JU15 Jumper Selection (CLK)**

SHUNT POSITION	CLK PIN CONNECTED TO	SPI CLOCK SUPPLIED BY
1-2	J1-2	External SPI controller
2-3*	U107, pin 7	On-board SPI controller
Not installed	Not connected	No clock source

\*Default position.

**Table 13. JU16 Jumper Selection (DIN)**

SHUNT POSITION	DIN PIN CONNECTED TO	SPI DATA INPUT SUPPLIED BY
1-2	J1-3	External SPI controller
2-3*	U101, pin 39	On-board SPI controller
Not installed	Not connected	No data-input source

\*Default position.

**Table 14. JU17 Jumper Selection (DOUT)**

SHUNT POSITION	DOUT PIN CONNECTED TO	SPI DATA OUTPUT SENT TO
1-2	J1-4	External SPI controller
2-3*	U106, pin 10	On-board SPI controller
Not installed	Not connected	No data-output destination

\*Default position.

# MAX16927 Evaluation Kit

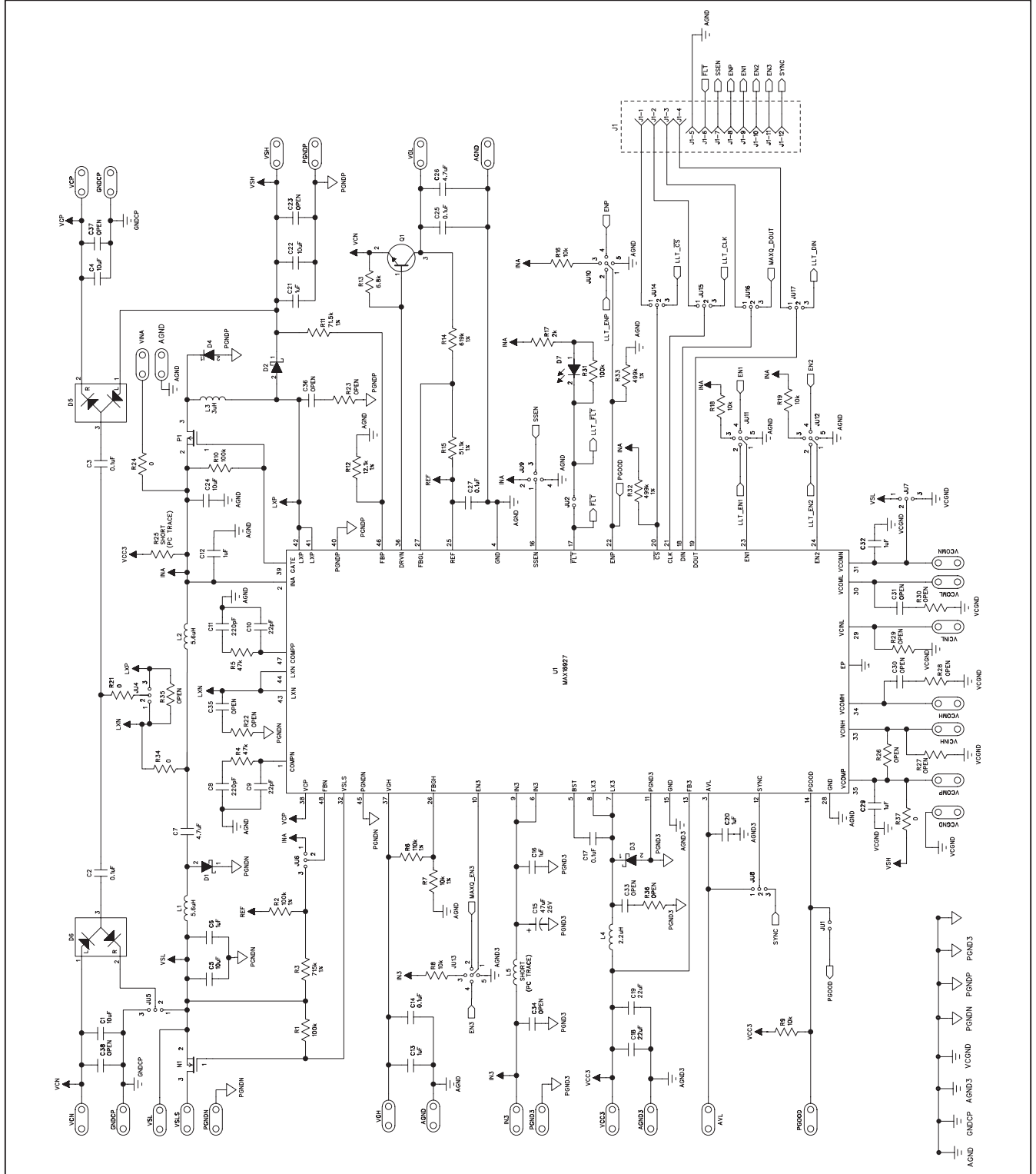

Figure 3a. MAX16927 EV Kit Schematic (Sheet 1 of 2)

# MAX16927 Evaluation Kit

Evaluates: MAX16927

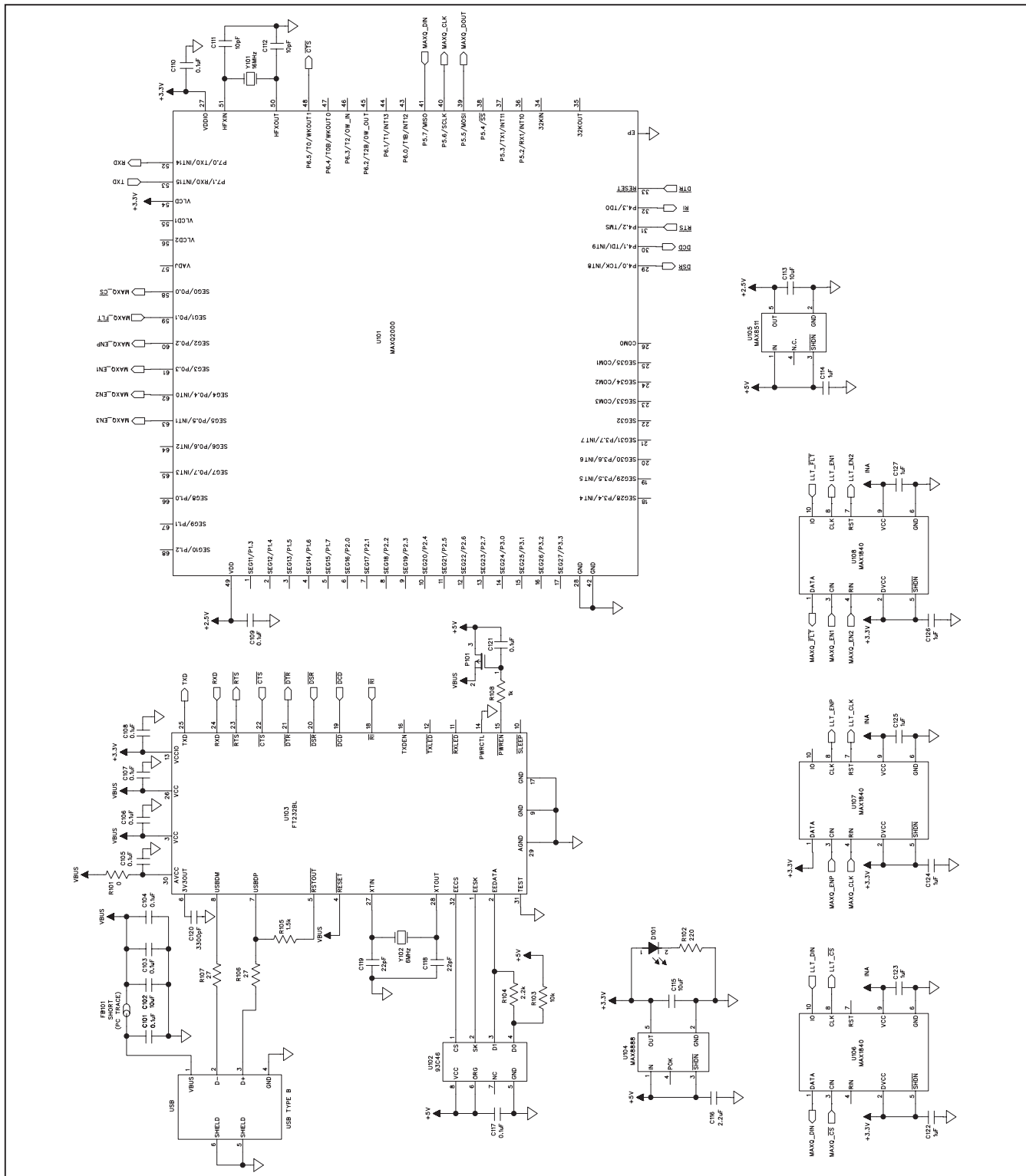

Figure 3b. MAX16927 EV Kit Schematic (Sheet 2 of 2)

# MAX16927 Evaluation Kit

Evaluates: MAX16927

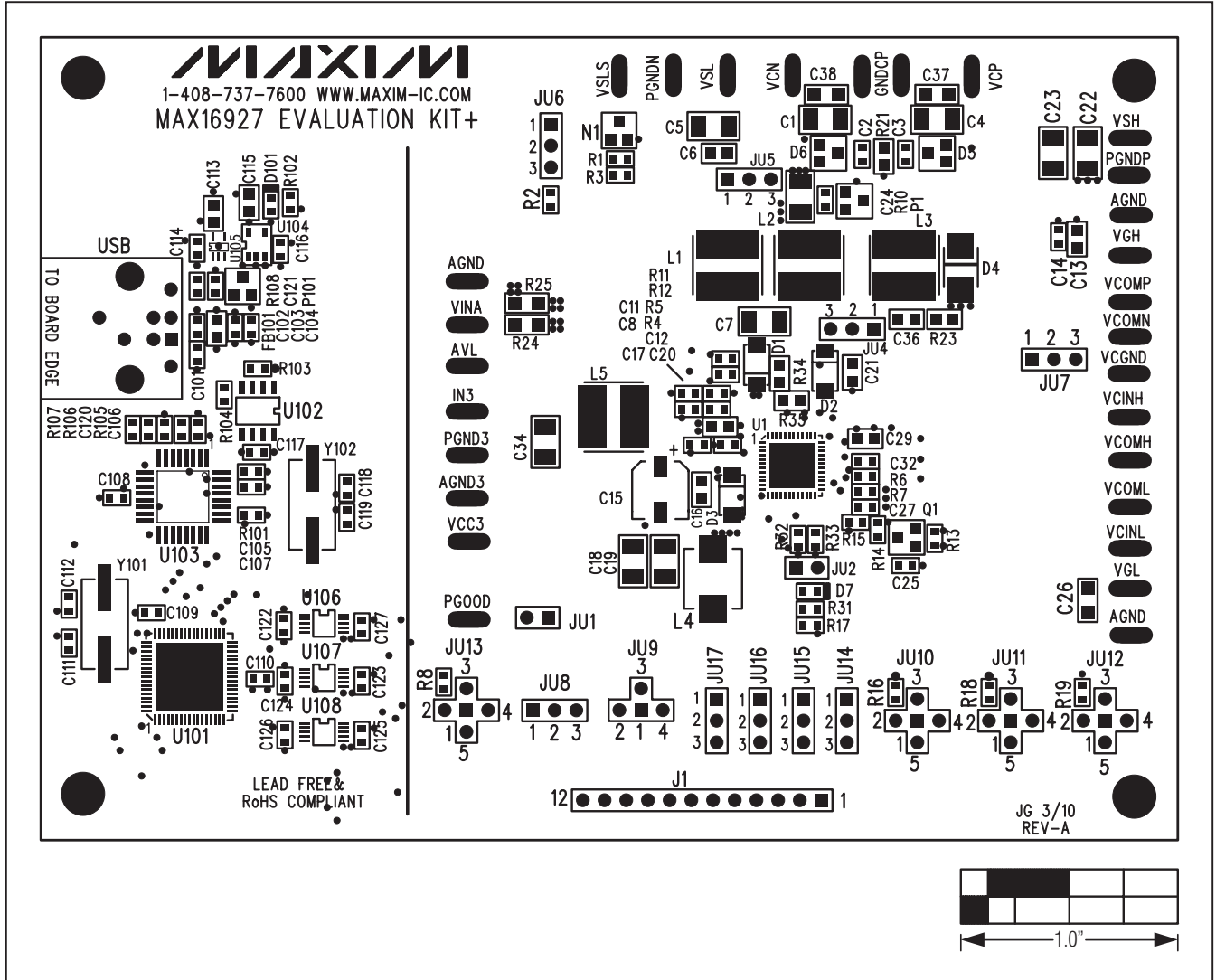

Figure 4. MAX16927 EV Kit Component Placement Guide—Component Side



# MAX16927 Evaluation Kit

Evaluates: MAX16927

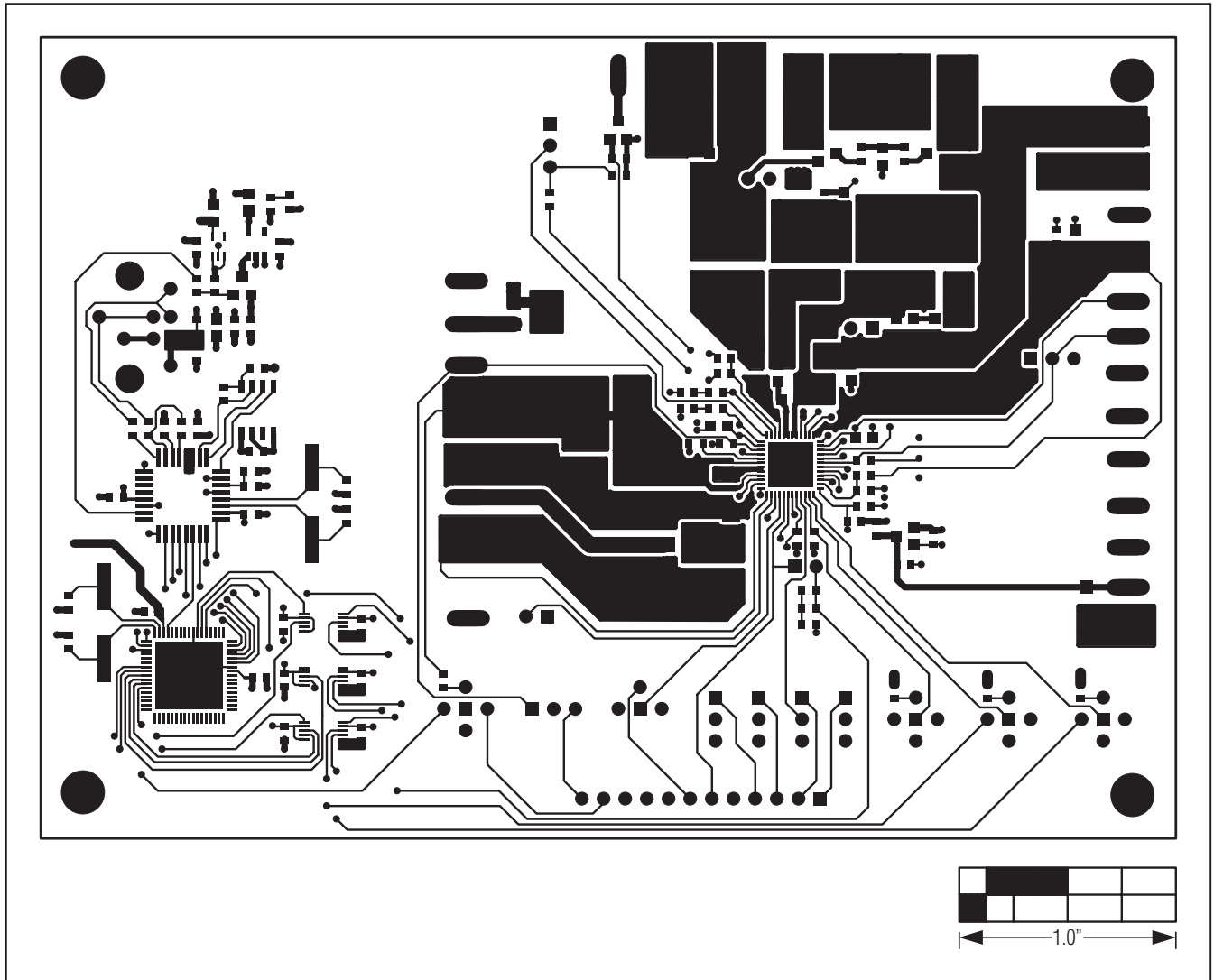

Figure 5. MAX16927 EV Kit PCB Layout—Component Side

# MAX16927 Evaluation Kit

Evaluates: MAX16927

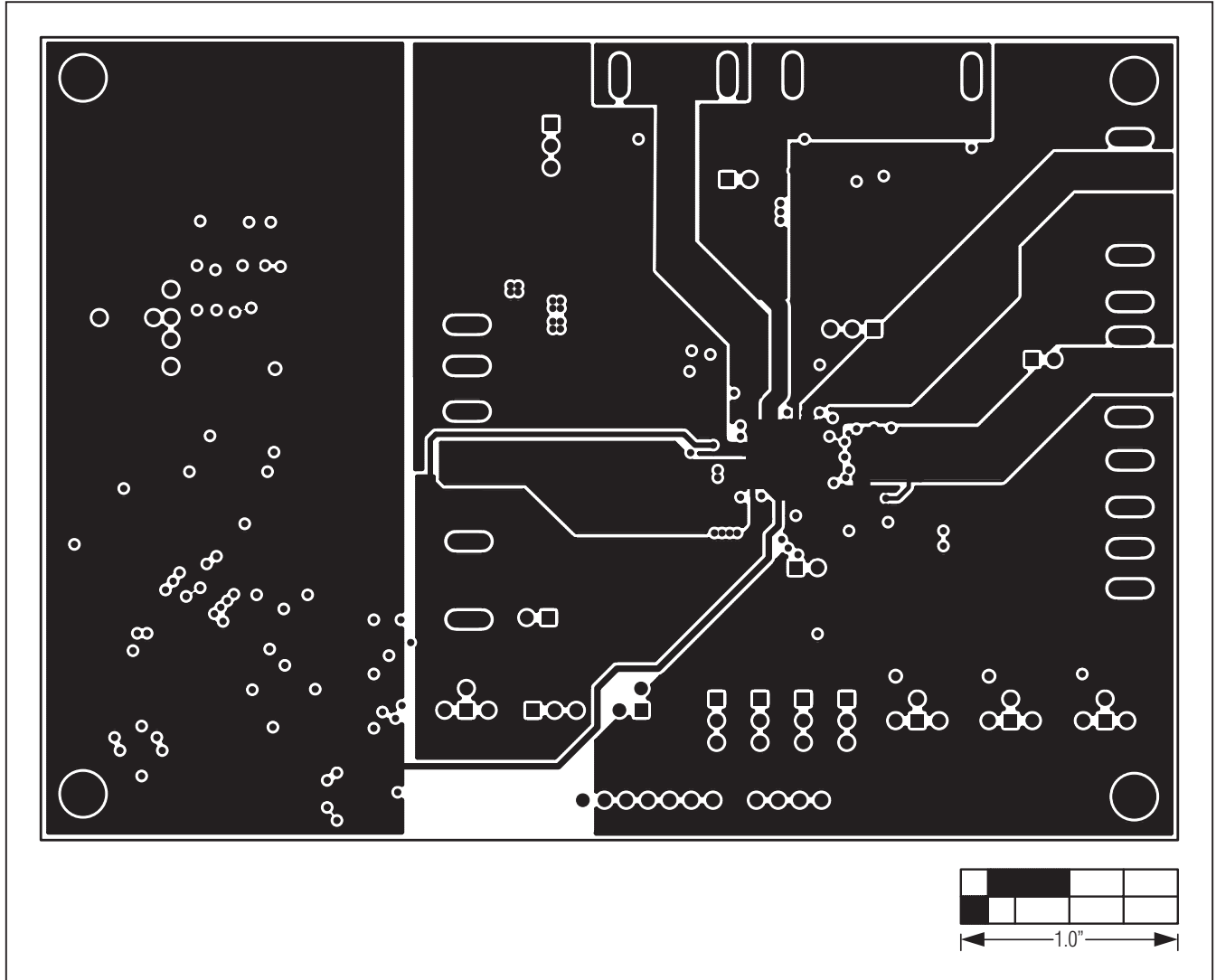

Figure 6. MAX16927 EV Kit PCB Layout—GND Layer 2

# MAX16927 Evaluation Kit

Evaluates: MAX16927

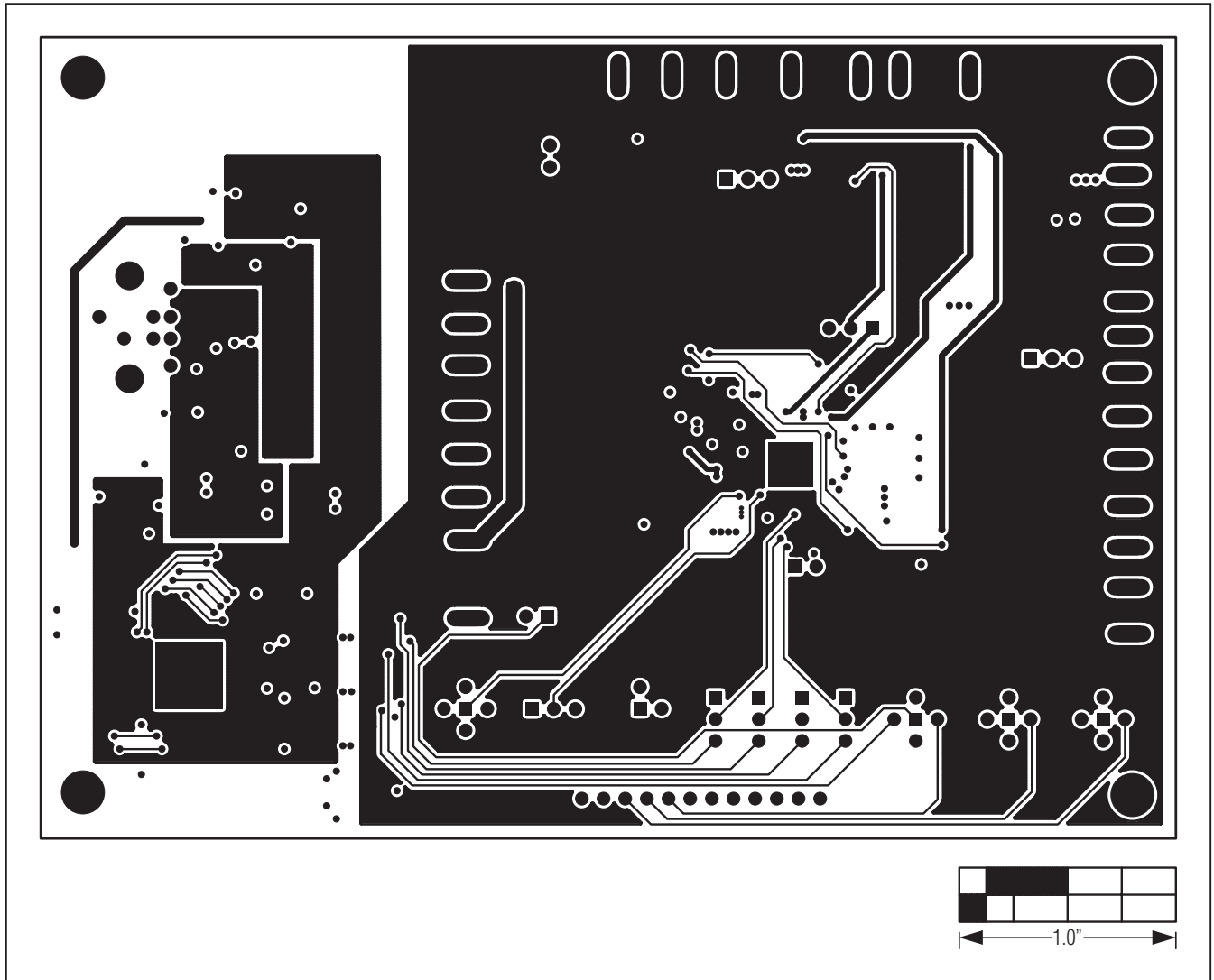

Figure 7. MAX16927 EV Kit PCB Layout—PWR Layer 3

# MAX16927 Evaluation Kit

Evaluates: MAX16927

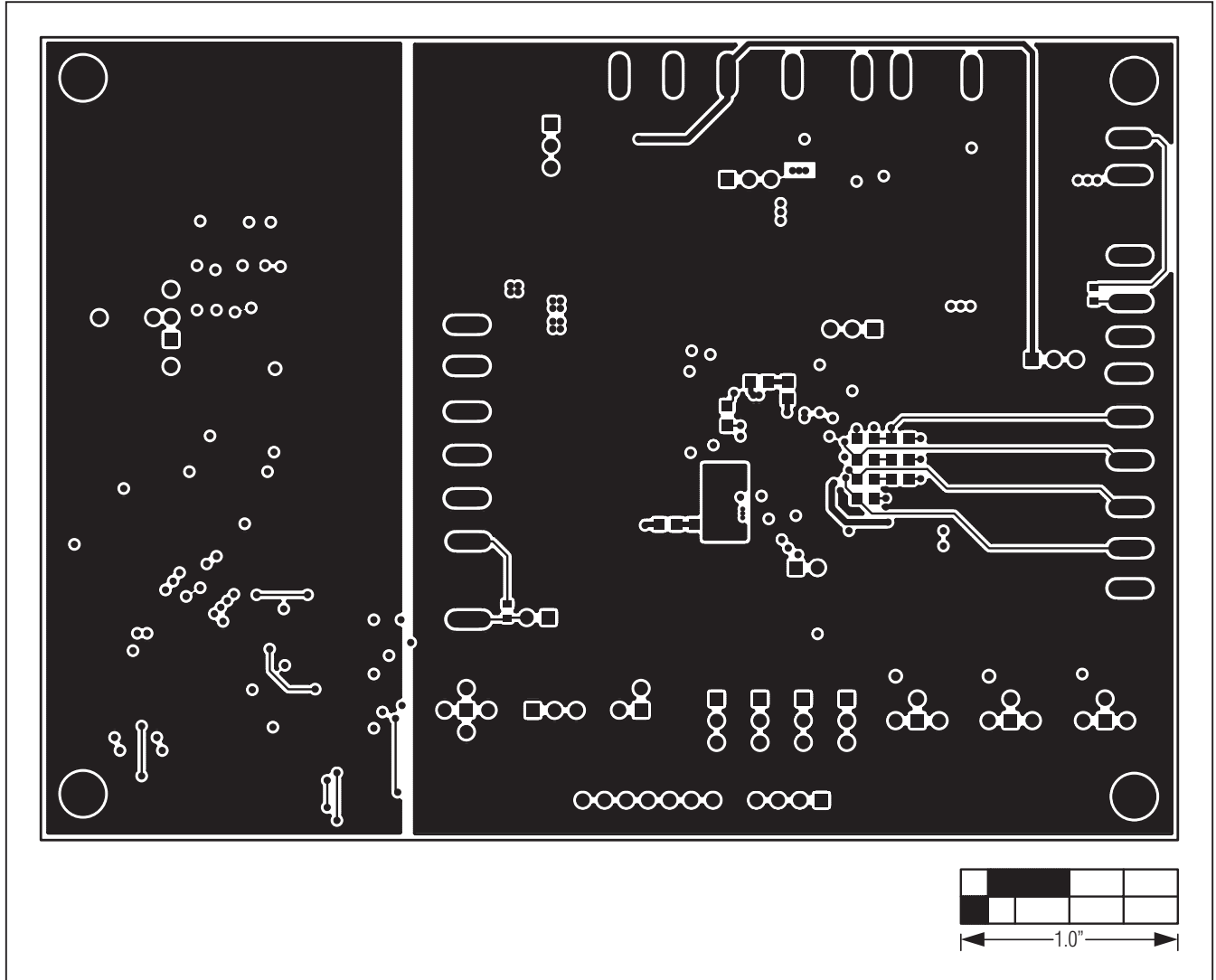

Figure 8. MAX16927 EV Kit PCB Layout—Solder Side

# MAX16927 Evaluation Kit

Evaluates: MAX16927

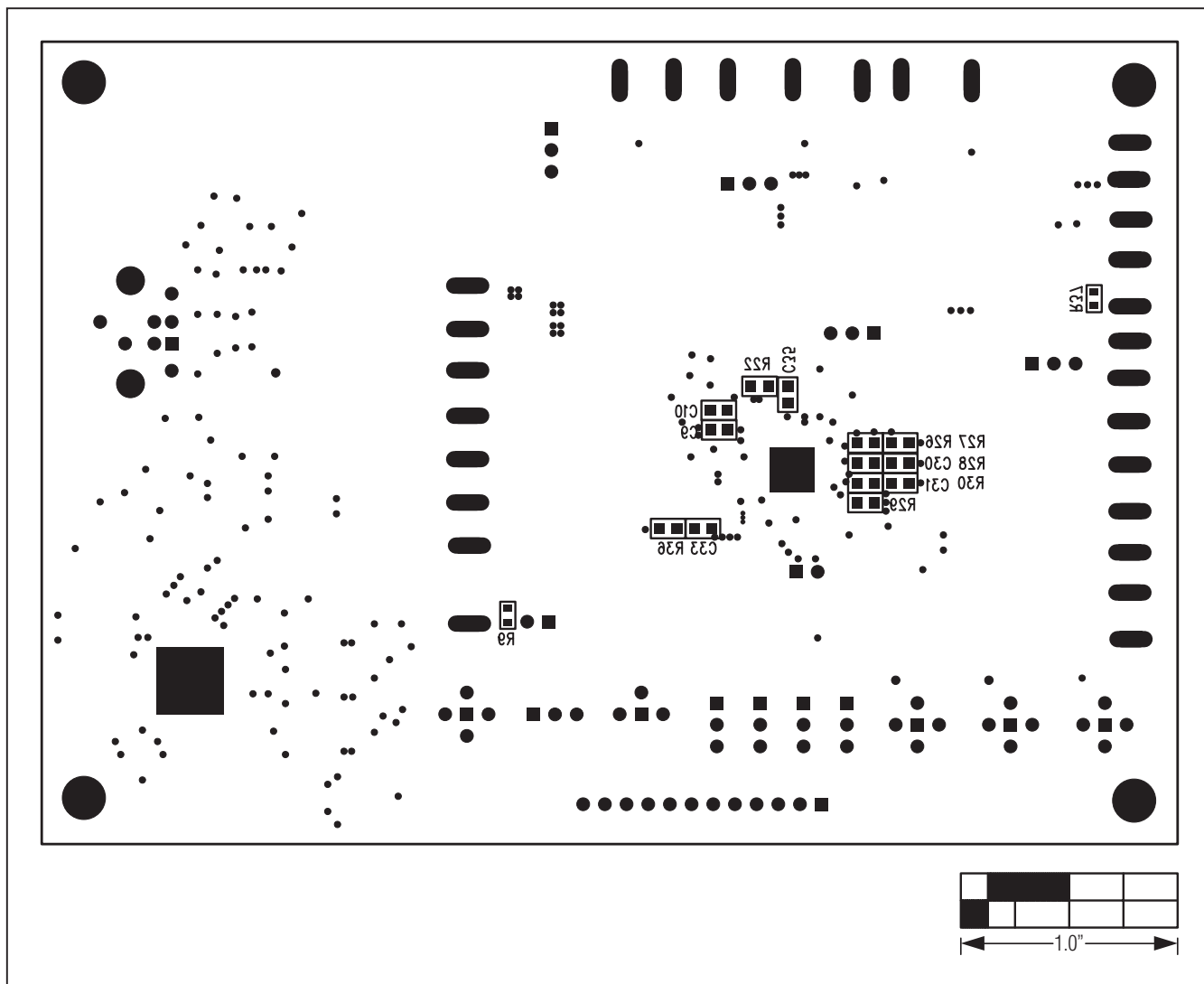

Figure 9. MAX16927 EV Kit Component Placement Guide—Solder Side

# MAX16927 Evaluation Kit

Evaluates: MAX16927

## Revision History

REVISION NUMBER	REVISION DATE	DESCRIPTION	PAGES CHANGED
0	10/10	Initial release	—

Maxim cannot assume responsibility for use of any circuitry other than circuitry entirely embodied in a Maxim product. No circuit patent licenses are implied. Maxim reserves the right to change the circuitry and specifications without notice at any time.

22 \_\_\_\_\_ **Maxim Integrated Products, 120 San Gabriel Drive, Sunnyvale, CA 94086 408-737-7600**

© 2010 Maxim Integrated Products

Maxim is a registered trademark of Maxim Integrated Products, Inc.

# Mouser Electronics

Authorized Distributor

Click to View Pricing, Inventory, Delivery & Lifecycle Information:

[Maxim Integrated:](#)

[MAX16927EVKIT+](#)