



Micro Commercial Components  
21201 Itasca Street Chatsworth  
CA 91311  
Phone: (818) 701-4933  
Fax: (818) 701-4939

# MMSZ5221B THRU MMSZ5259B

## Features

- Planar Die construction
- 500mW Power Dissipation
- Zener Voltages from 2.4V - 39V
- Ideally Suited for Automated Assembly Processes

**500 mW**

**Zener Diodes**

**2.4 to 39 Volts**

## Mechanical Data

- Case: SOD-123, Molded Plastic
- Terminals: Solderable per MIL-STD-202, Method 208
- Approx. Weight: 0.008 grams
- Mounting Position: Any
- Storage & Operating Temperature: -55°C to +150°C

Maximum Ratings @ 25°C Unless Otherwise Specified

<b>Zener Current</b>	<b>I<sub>F</sub></b>	<b>100</b>	<b>mA</b>
<b>Maximum Forward Voltage</b>	<b>V<sub>F</sub></b>	<b>1.2</b>	<b>V</b>
<b>Power Dissipation (Notes A)</b>	<b>P<sub>(AV)</sub></b>	<b>500</b>	<b>mWatt</b>
<b>Peak Forward Surge Current (Notes B)</b>	<b>I<sub>FSM</sub></b>	<b>4.0</b>	<b>Amps</b>

### NOTES:

- A. Mounted on 5.0mm<sup>2</sup> (.013mm thick) land areas.  
B. Measured on 8.3ms, single half sine-wave or equivalent square wave, duty cycle = 4 pulses per minute maximum.

## SOD123

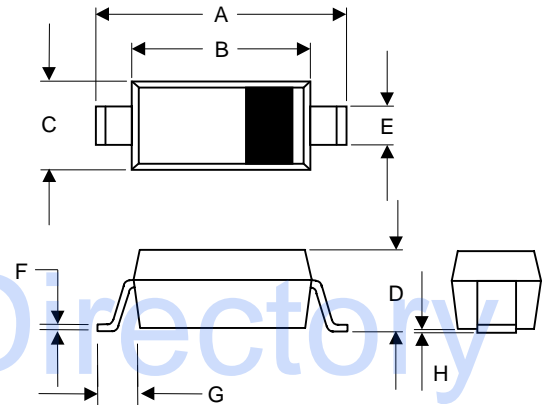

DIM	DIMENSIONS				NOTE
	INCHES		MM		
A	.141	.154	3.60	3.90	
B	.098	.110	2.50	2.80	
C	.055	.071	1.40	1.80	
D	.037	.053	0.95	1.35	
E	.019	.028	0.50	0.70	
F	---	.008	---	0.20	
G	.016	---	0.40	---	
H	---	.005	---	0.12	

### SUGGESTED SOLDER PAD LAYOUT

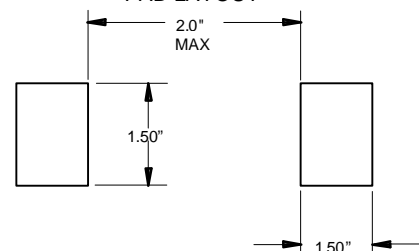

# MMSZ5221B thru MMSZ5259B

Electrical Characteristics @ 25°C Unless Otherwise Specified

MCC PART NUMBER	Marking	NORMAL ZENER VOLTAGE Vz @ Izt	TEST CURRENT Izt	MAXIMUM ZENER IMPEDANCE 'B' SUFFIX ONLY		MAXIMUM REVERSE LEAKAGE CURRENT Ir @ Vr		MAXIMUM ZENER VOLTAGE TEMP COEFFICIENT 'B' SUFFIX ONLY
				Zzt @ Izt	Zzk @ Izk=0.25mA	uA	VOLTS	
		VOLTS	mA	OHMS	OHMS			
MMSZ5221B	C1	2.4	20	30	1200	100	1.0	-0.085
MMSZ5222B	C2	2.5	20	30	1250	100	1.0	-0.085
MMSZ5223B	C3	2.7	20	30	1300	75	1.0	-0.080
MMSZ5225B	C5	3.0	20	29	1600	50	1.0	-0.075
MMSZ5226B	D1	3.3	20	28	1600	25	1.0	-0.070
MMSZ5227B	D2	3.6	20	24	1700	15	1.0	-0.065
MMSZ5228B	D3	3.9	20	23	1900	10	1.0	-0.060
MMSZ5229B	D4	4.3	20	22	2000	5.0	1.0	±0.055
MMSZ5230B	D5	4.7	20	19	1900	5.0	2.0	±0.030
MMSZ5231B	E1	5.1	20	17	1600	5.0	2.0	±0.030
MMSZ5232B	E2	5.6	20	11	1600	5.0	3.0	+0.038
MMSZ5234B	E4	6.2	20	7.0	1000	5.0	4.0	+0.045
MMSZ5235B	E5	6.8	20	5.0	750	3.0	5.0	+0.050
MMSZ5236B	F1	7.5	20	6.0	500	3.0	6.0	+0.058
MMSZ5237B	F2	8.2	20	8.0	500	3.0	6.5	+0.062
MMSZ5239B	F4	9.1	20	10	600	3.0	7.0	+0.068
MMSZ5240B	F5	10	20	17	600	3.0	8.0	+0.075
MMSZ5241B	H1	11	20	22	600	2.0	8.4	+0.076
MMSZ5242B	H2	12	20	30	600	1.0	9.1	+0.077
MMSZ5243B	H3	13	9.5	13	600	0.5	9.9	+0.079
MMSZ5245B	H5	15	8.5	16	600	0.1	11	+0.082
MMSZ5246B	J1	16	7.8	17	600	0.1	12	+0.083
MMSZ5248B	J3	18	7.0	21	600	0.1	14	+0.085
MMSZ5250B	J5	20	6.2	25	600	0.1	15	+0.086
MMSZ5251B	K1	22	5.6	29	600	0.1	17	+0.087
MMSZ5252B	K2	24	5.2	33	600	0.1	18	+0.088
MMSZ5254B	K4	27	4.6	41	600	0.1	21	+0.090
MMSZ5255B	K5	28	4.5	44	600	0.1	21	+0.091
MMSZ5256B	M1	30	4.2	49	600	0.1	23	+0.091
MMSZ5257B	M2	33	3.8	58	700	0.1	25	+0.092
MMSZ5258B	M3	36	3.4	70	700	0.1	27	+0.093
MMSZ5259B	M4	39	3.2	80	800	0.1	30	+0.094

NOTE:

1. Tolerance and Type Number Designation. The type numbers listed have a standard tolerance on the nominal zener voltage of ±5%.
2. Specials Available Include:
  - A. Nominal zener voltages between the voltages shown and tighter voltage tolerances.
  - B. Matched sets.
3. Zener Voltage (Vz) Measurement. Guarantees the zener voltage when measured at 90 seconds while maintaining the lead temperature (TL) at 30°C, from the diode body.
4. Zener Impedance (Zz) Derivation. The zener impedance is derived from the 60 cycle ac voltage, which results when an AC current having an rms value equal to 10% of the dc zener current (Izt or Izk) is superimposed on Izt or Izk.
5. Surge Current (Ir) Non-Repetitive. The rating listed in the electrical characteristics table is maximum peak, non-repetitive, reverse surge current of 1/2 square wave or equivalent sine wave pulse of 1/120 second duration superimposed on the test current, Izt, per JEDEC registration; however, actual device capability is as described in Figure 5.

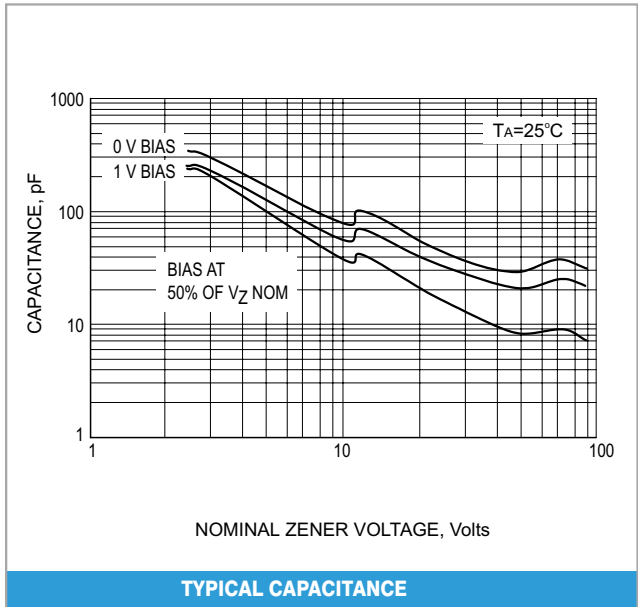
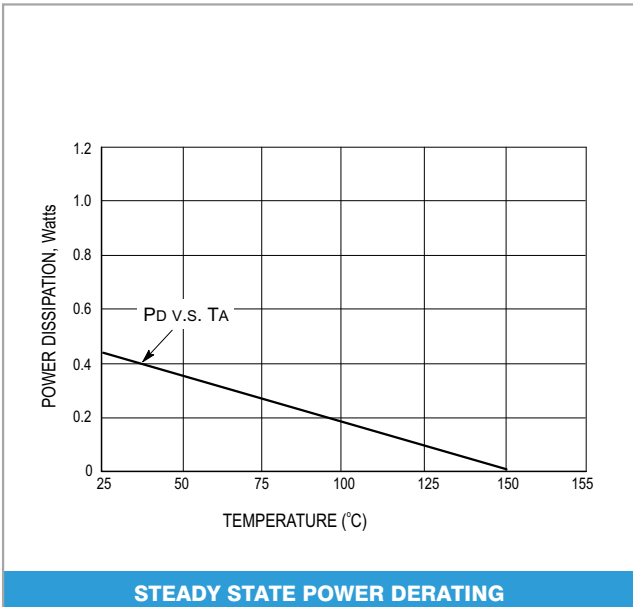
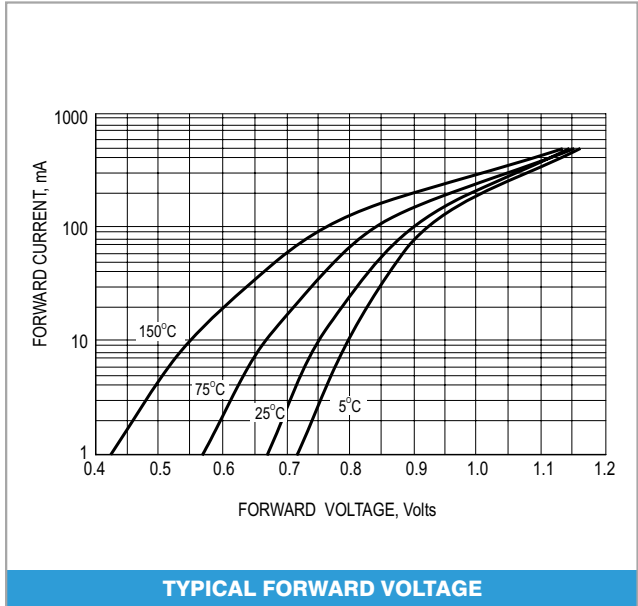
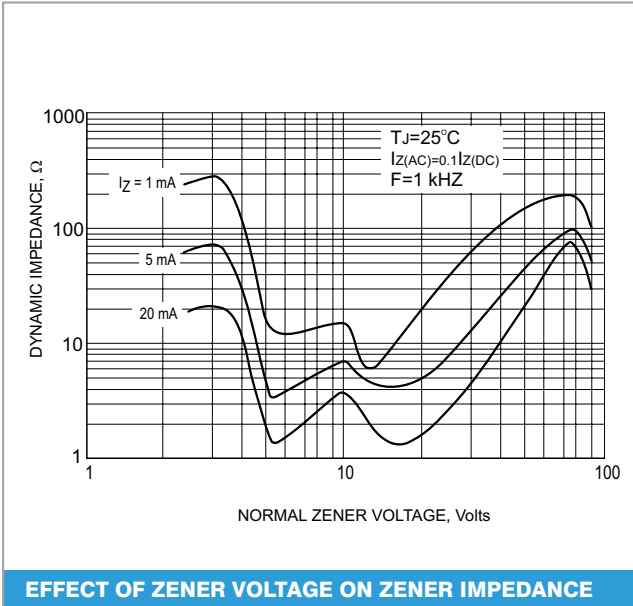
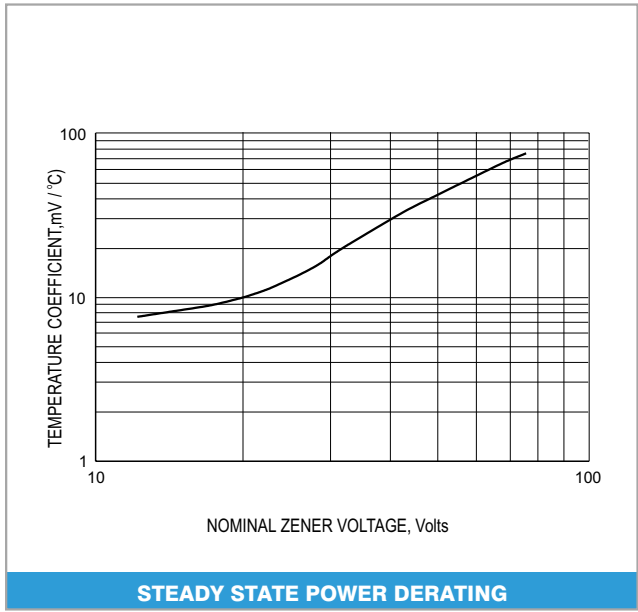
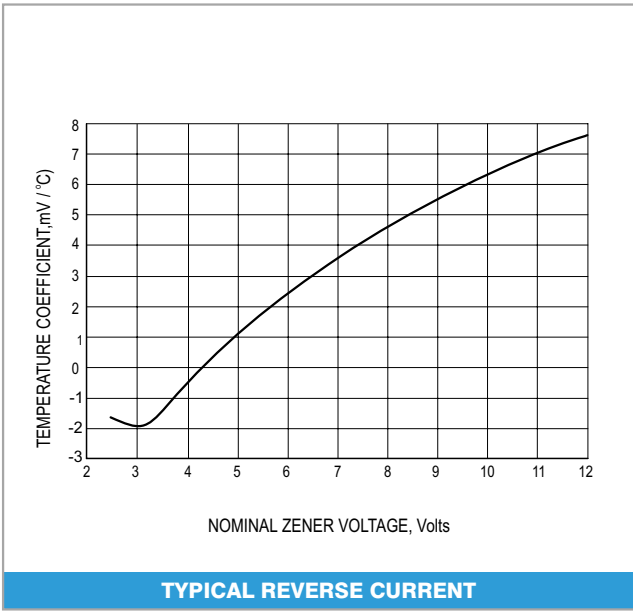

# MMSZ5221B thru MMSZ5259B

