

### Features

- 32.768 kHz  $\pm 5$ ,  $\pm 10$ ,  $\pm 20$  ppm frequency stability options over temp
- Operating temperature ranges:
  - 0°C to +70°C
  - -40°C to +85°C
- Three package options: 2.0 x 1.2 mm (2012) SMD, SOT23-5<sup>[1]</sup>, 1.5 x 0.8 mm CSP
- Ultra-low power: <1  $\mu$ A
- Vdd supply range: 1.5V to 3.63V
- Improved stability reduces system power with fewer network timekeeping updates
- NanoDrive™ programmable output swing for lowest power and direct XTAL SoC input interface
- Internal filtering eliminates external Vdd bypass cap and saves space
- Pb-free, RoHS and REACH compliant

### Applications

- Smart Meters (AMR)
- Health and Wellness Monitors
- Pulse-per-Second (pps) Timekeeping
- RTC Reference Clock



INSTANT  
SAMPLES



GREEN  
SOLUTIONS



LIFETIME  
WARRANTY



### Electrical Characteristics

Parameter	Symbol	Min.	Typ.	Max.	Unit	Condition
<b>Frequency and Stability</b>						
Output Frequency	F <sub>out</sub>	32.768			kHz	
Initial Tolerance	F <sub>init</sub>	-5.0		5.0	ppm	T <sub>A</sub> = 25°C, includes reflow. Tested with Agilent 53132A freq. counter, gate time $\geq$ 100ms.
Frequency Stability Over Temperature	F <sub>stab</sub>	-5.0		5.0	ppm	Stability part number code = E, includes $\pm 20\%$ load variation
		-10		10		Stability part number code = F, includes $\pm 20\%$ load variation
		-20		20		Stability part number code = 1, includes $\pm 20\%$ load variation
Frequency Stability vs Voltage	F <sub>vdd</sub>	-0.75		0.75	ppm	1.8V $\pm 10\%$
		-1.5		1.5	ppm	1.5V – 3.63V
First Year Frequency Aging	F <sub>aging</sub>	-1.0		1.0	ppm	T <sub>A</sub> = 25°C, Vdd = 3.0V
<b>Jitter Performance (T<sub>A</sub> = over temp)</b>						
Long Term Jitter				2.5	$\mu$ s <sub>pp</sub>	81920 cycles (2.5 sec), 100 samples
Period Jitter			35		ns <sub>RMS</sub>	N = 10,000, T <sub>A</sub> = 25°C, Vdd = 1.5V – 3.63V
<b>Supply Voltage and Current Consumption</b>						
Operating Supply Voltage	Vdd	1.5		3.63	V	T <sub>A</sub> = -40°C to +85°C
Core Supply Current	I <sub>dd</sub>		0.99		$\mu$ A	T <sub>A</sub> = 25°C, Vdd = 1.8V, LVCMOS Output configuration, No Load
				1.52		T <sub>A</sub> = -40°C to +85°C, Vdd = 1.5V – 3.63V, No Load
Power-Supply Ramp	t <sub>Vdd_Ramp</sub>			100	ms	Vdd Ramp-Up 0 to 90% Vdd, T <sub>A</sub> = -40°C to +85°C
Start-up Time at Power-up	t <sub>start</sub>		200	300	ms	Valid Output with frequency stability specifications.

#### Notes:

1. Contact Factory for SOT23-5 availability.
2. Core operating current does not include output driver operating current or load current. To derive total operating current (no load), add core operating current + output driver operating current, which is a function of the output voltage swing. See the description titled, **Calculating Load Current**.

### Electrical Characteristics (continued)

Parameter	Symbol	Min.	Typ.	Max.	Unit	Condition
<b>Operating Temperature Range</b>						
Commercial Temperature	Op_Temp	0		70	°C	
Industrial Temperature		-40		85	°C	
Extended Industrial Temperature		-40		105	°C	Contact Factory for availability
<b>LVC MOS Output</b>						
Output Rise/Fall Time	tr, tf		100	200	ns	10-90%, 15 pF Load
Output Clock Duty Cycle	DC	48		52	%	
Output Voltage High	VOH	90%			V	Vdd: 1.5V – 3.63V. IOH = -1 µA, 15 pF Load
Output Voltage Low	VOL			10%	V	Vdd: 1.5V – 3.63V. IOL = 1 µA, 15 pF Load
<b>NanoDrive™ Reduced Swing Output</b>						
Output Rise/Fall Time	tr, tf			200	ns	10-90%, 15 pF Load
Output Clock Duty Cycle	DC	48		52	%	
AC-coupled Programmable Output Swing	V_sw		0.20 to 0.80		V	SiT1552 does not internally AC-couple. This output description is intended for a receiver that is AC-coupled. Vdd: 1.5V – 3.63V, 10 pF Load, IOH / IOL = ±0.2 µA
DC-Biased Programmable Output Voltage High Range	VOH		0.6 to 1.225		V	Vdd: 1.5V – 3.63V. IOH = -0.2 µA, 10 pF Load
DC-Biased Programmable Output Voltage Low Range	VOL		0.35 to 0.80		V	Vdd: 1.5V – 3.63V. IOL = 0.2 µA, 10 pF Load
Programmable Output Voltage Swing Tolerance		-0.055		0.055	V	TA = -40°C to +85°C. Vdd = 1.5V to 3.63V. See Tables 1 and -2 for acceptable NanoDrive Settings.

### Pin Configuration

SMD Pin	CSP Pin	SOT23-5 Pin	Symbol	I/O	Functionality
1	n/a	2	NC	No Connect	No Connect. Will not respond to any input signal. When interfacing to an MCU's XTAL input pins, this pin is typically connected to the receiving IC's X IN pin. In this case, the SiT1552 will not be affected by the signal on this pin. If not interfacing to an XTAL oscillator, leave pin 1 floating (no connect).
2	1, 4	1, 5	GND	Power Supply Ground	Connect to ground. All GND pins must be connected to power supply ground. The GND pins on the SOT23 and CSP packages can be connected together, as long as both GND pins are connected ground.
3	2	4	CLK Out	OUT	Oscillator clock output. When interfacing to an MCU's XTAL, the CLK Out is typically connected to the receiving IC's X IN pin. The SiT1552 oscillator output includes an internal driver. As a result, the output swing and operation is not dependent on capacitive loading. This makes the output much more flexible, layout independent, and robust under changing environmental and manufacturing conditions.
4	3	3	Vdd	Power Supply	Connect to power supply 1.5V ≤ Vdd ≤ 3.63V. Under normal operating conditions, Vdd does not require external bypass/decoupling capacitor(s). Internal power supply filtering will reject more than 500 mV <sub>pp</sub> with frequency components through 10 MHz. Contact factory for applications that require a wider operating supply voltage range.

SMD Package (Top View)

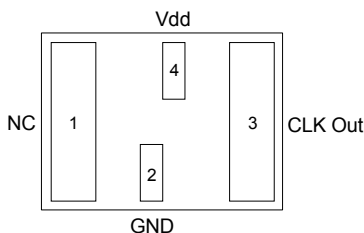

CSP Package (Top View)

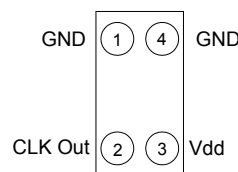

SOT23-5 Package (Top View)

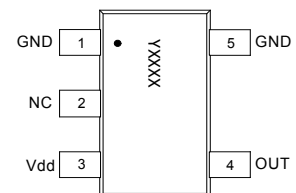

### System Block Diagram

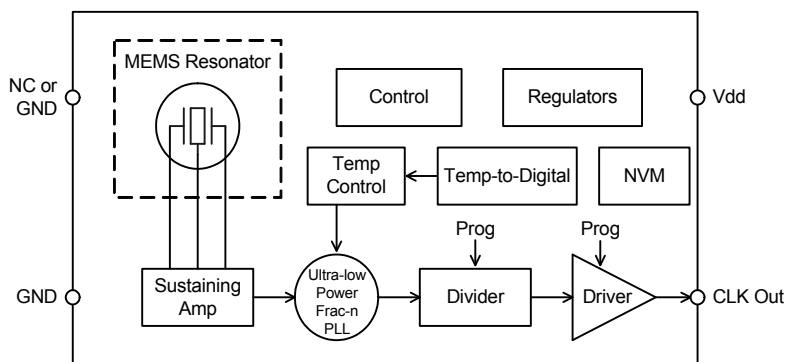

Figure 1.

### Absolute Maximum

Attempted operation outside the absolute maximum ratings cause permanent damage to the part. Actual performance of the IC is only guaranteed within the operational specifications, not at absolute maximum ratings.

Parameter	Test Condition	Value	Unit
Continuous Power Supply Voltage Range (Vdd)		-0.5 to 3.63	V
Short Duration Maximum Power Supply Voltage (Vdd)	≤30 minutes	4.0	V
Continuous Maximum Operating Temperature Range	Vdd = 1.5V - 3.63V	105	°C
Short Duration Maximum Operating Temperature Range	Vdd = 1.5V - 3.63V, ≤30 mins	125	°C
Human Body Model (HBM) ESD Protection	JESD22-A114	3000	V
Charge-Device Model (CDM) ESD Protection	JESD22-A115	750	V
Machine Model (MM) ESD Protection	JESD22-C101	300	V
Latch-up Tolerance	JESD78 Compliant		
Mechanical Shock Resistance	Mil 883, Method 2002	10,000	g
Mechanical Vibration Resistance	Mil 883, Method 2007	70	g
2012 SMD Junction Temperature		150	°C
1508 CSP Junction Temperature		150	°C
SOT23-5 Junction Temperature		150	°C
Storage Temperature		-65°C to 150°C	

### Thermal Consideration

Package	θJA, 4 Layer Board (°C/W)	θJA, 2 Layer Board (°C/W)	θJC, Bottom (°C/W)
2012 SMD	TBD		
1508 CSP	TBD		
SOT23-5	TBD		

### Description

The SiT1552 is an ultra-small and ultra-low power 32.768 kHz TCXO optimized for battery-powered applications. SiTime's silicon MEMS technology enables the first 32 kHz TCXO in the world's smallest footprint and chip-scale packaging (CSP). Typical core supply current is only 1  $\mu$ A. And unlike standard oscillators, the SiT1552 features NanoDrive™, a factory programmable output that reduces the voltage swing to minimize power.

SiTime's MEMS oscillators consist of MEMS resonators and a programmable analog circuit. Our MEMS resonators are built with SiTime's unique MEMS First™ process. A key manufacturing step is EpiSeal™ during which the MEMS resonator is annealed with temperatures over 1000°C. EpiSeal creates an extremely strong, clean, vacuum chamber that encapsulates the MEMS resonator and ensures the best performance and reliability. During EpiSeal, a poly silicon cap is grown on top of the resonator cavity, which eliminates the need for additional cap wafers or other exotic packaging. As a result, SiTime's MEMS resonator die can be used like any other semiconductor die. One unique result of SiTime's MEMS First and EpiSeal manufacturing processes is the capability to integrate SiTime's MEMS die with a SOC, ASIC, microprocessor or analog die within a package to eliminate external timing components and provide a highly integrated, smaller, cheaper solution to the customer.

### TCXO Frequency Stability

The SiT1552 is factory calibrated (trimmed) over multiple frequency points to guarantee extremely tight stability over temperature. Unlike quartz crystals that have a classic tuning fork parabola temperature curve with a 25°C turnover point with a 0.04 ppm/C<sup>2</sup> temperature coefficient, the SiT1552 temperature coefficient is calibrated and corrected over temperature with an active temperature correction circuit. The result is 32 kHz TCXO with extremely tight frequency variation over the -40°C to +85°C temperature range. Contact SiTime for applications that require a wider supply voltage range >3.63V, or lower operating frequency below 32 kHz.

When measuring the SiT1552 output frequency with a frequency counter, it is important to make sure the counter's gate time is  $\geq$ 100ms. The slow frequency of a 32kHz clock will give false readings with faster gate times.

### Power Supply Noise Immunity

In addition to eliminating external output load capacitors common with standard XTALs, this device includes special power supply filtering and thus, eliminates the need for an external Vdd bypass-decoupling capacitor to keep the footprint as small as possible. Internal power supply filtering is designed to reject more than 500 mV noise and frequency components from low frequency to more than 10 MHz.

### Start-up and Steady-State Supply Current

The SiT1552 TCXO starts-up to a valid output frequency within 300 ms (150ms typ). To ensure proper start-up, Vdd power-supply ramp, from a power-down state to 90% of final Vdd, must be less than 100ms.

During initial power-up, the SiT1552 power-cycles internal blocks, as shown in the power-supply start-up and steady state plot in the *Typical Operating Curves* section. Power-up and initialization is typically 200 ms, and during that time, the peak supply current reaches 28  $\mu$ A as the internal capacitors are charged, then sequentially drops to its 990 nA steady-state current. During steady-state operation, the internal temperature compensation circuit turns on every 350 ms for a duration of approximately 10 ms.

### Output Voltage

The SiT1552 has two output voltage options. One option is a standard LVCMOS output swing. The second option is the NanoDrive reduced swing output. Output swing is customer specific and Factory programmed between 200 mV and 800 mV. For DC-coupled applications, output V<sub>OH</sub> and V<sub>OL</sub> are individually factory programmed to the customers' requirement. V<sub>OH</sub> programming range is between 600 mV and 1.225V in 100 mV increments. Similarly, V<sub>OL</sub> programming range is between 350 mV and 800 mV. For example; a PMIC or MCU is internally 1.8V logic compatible, and requires a 1.2V V<sub>IH</sub> and a 0.6V V<sub>IL</sub>. Simply select SiT1552 NanoDrive factory programming code to be "D14" and the correct output thresholds will match the downstream PMIC or MCU input requirements. Interface logic will vary by manufacturer and we recommend that you review the input voltage requirements for the input interface.

For DC-biased NanoDrive output configuration, the minimum V<sub>OL</sub> is limited to 350mV and the maximum allowable swing (V<sub>OH</sub> - V<sub>OL</sub>) is 750mV. For example, 1.1V V<sub>OH</sub> and 400mV V<sub>OL</sub> is acceptable, but 1.2V V<sub>OH</sub> and 400 mV V<sub>OL</sub> is not acceptable.

When the output is interfacing to an XTAL input that is internally AC-coupled, the SiT1552 output can be Factory programmed to match the input swing requirements. For example, if a PMIC or MCU input is internally AC-coupled and requires an 800mV swing, then simply choose the SiT1552 NanoDrive programming code "AA8" in the part number. It is important to note that the SiT1552 does not include internal AC-coupling capacitors. Please see the *Part Number Ordering* section at the end of the datasheet for more information about the part number ordering scheme.

# SiT1552

## Ultra-Low Power, Ultra-Small 32.768 kHz MEMS TCXO

### SiT1552 NanoDrive™

Figure 3 shows a typical output waveform of the SiT1552 (into a 10 pF load) when factory programmed for a 0.70V swing and DC bias ( $V_{OH}/V_{OL}$ ) for 1.8V logic:

**Example:**

- NanoDrive part number coding: D14. Example part number: SiT1552AI-J4-D14-32.768
- $V_{OH} = 1.1V$ ,  $V_{OL} = 0.4V$  ( $V_{SW} = 0.70V$ )

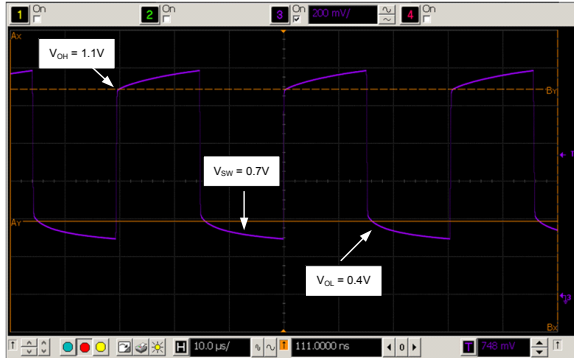

**Figure 2. SiT1552AI-J4-D14-32.768 Output Waveform (10 pF load)**

Table 1 shows the supported NanoDrive  $V_{OH}$ ,  $V_{OL}$  factory programming options.

**Table 1. Acceptable  $V_{OH}/V_{OL}$  NanoDrive Levels**

$V_{OL}/V_{OH}$	1.225	1.100	1.000	0.900	0.800	0.700	0.600
0.800	D28	D18	D08				
0.700	D27	D17	D07	D97			
0.525	D26	D16	D06	D96	D86		
0.500	D25	D15	D05	D95	D85	D75	
0.400		D14	D04	D94	D84	D74	D64
0.350		D13	D03	D93	D83	D73	D63

Table 2 shows the supported AC coupled Swing levels. The “AC-coupled” terminology refers to the programming description for applications where the downstream chipsets includes an internal AC-coupling capacitor, and therefore, only the output swing is important and  $V_{OH}/V_{OL}$  is not relevant. For these applications, refer to Table 2 for the acceptable voltage swing options.

**Table 2. Acceptable NanoDrive Voltage Swing Options (for downstream AC-coupled receivers)**

Swing	0.800	0.700	0.600	0.500	0.400	0.300	0.250	0.200
Output Code	AA8	AA7	AA6	AA5	AA4	AA3	AA2	AA1

**Example:**

- NanoDrive part number coding: AA2. Example part number: SiT1552AI-J4-AA2-32.768
- Output voltage swing: 0.250V

The values listed in Tables 1 and -2 are nominal values at 25°C and will exhibit a tolerance of ±55 mV across  $V_{DD}$  and -40°C to 85°C operating temperature range.

### SiT1552 Full Swing LVCMOS Output

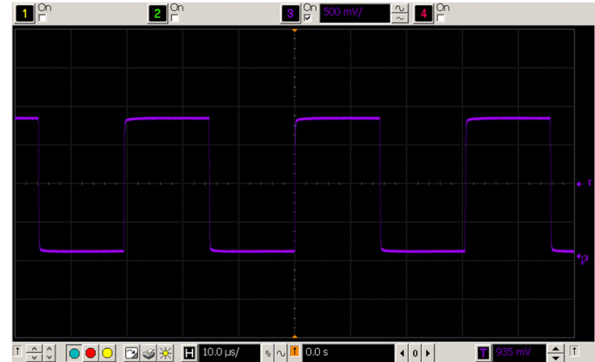

**Figure 3. LVCMOS Waveform ( $V_{DD} = 1.8V$ ) into 15 pF Load**

**Example:**

- LVCMOS output part number coding is always DCC
- Example part number: SiT1552AI-J4-DCC-32.768

# SiT1552

Ultra-Low Power, Ultra-Small 32.768 kHz MEMS TCXO



## Typical Operating Curves

( $T_A = 25^\circ\text{C}$ ,  $V_{DD} = 1.8\text{V}$ , unless otherwise stated)

### Initial Tolerance Histogram

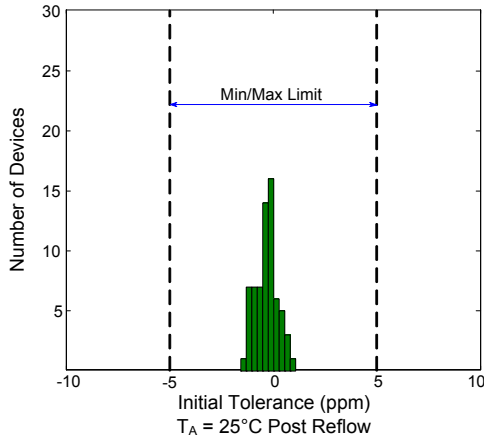

### NanoDrive™ Output Waveform

( $V_{OH} = 1.2\text{V}$ ,  $V_{OL} = 0.4\text{V}$ , 10 pF Load;  
SiT1552AI-AI-D14-32.768)

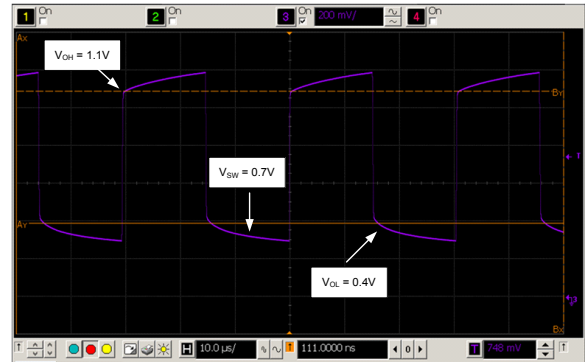

### Frequency Stability Over Temperature

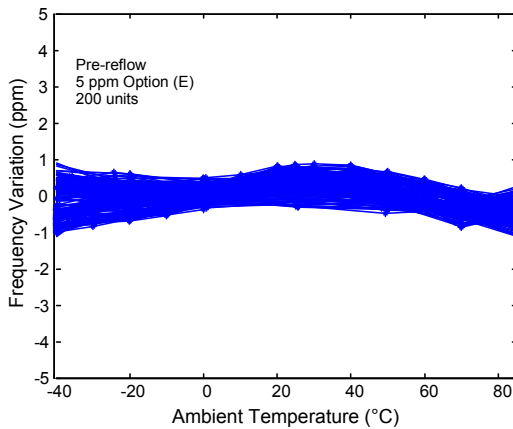

### LVC MOS Output Waveform

(SiT1552AI-JE-DCC-32.768, 10 pF Load)

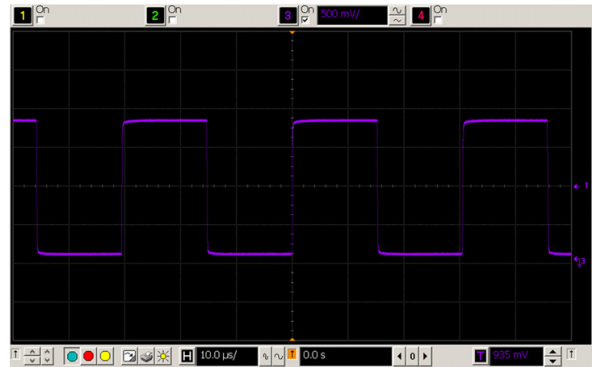

### Start-up and Steady-State Current Profile

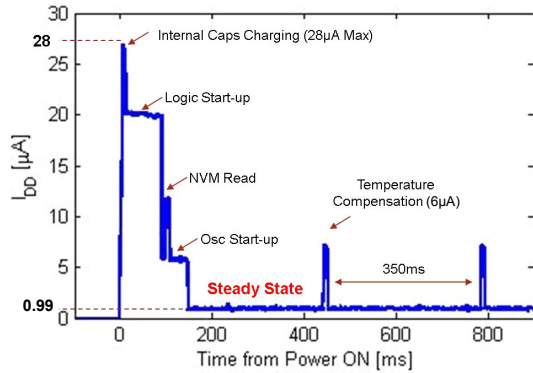

### Calculating Load Current

#### No Load Supply Current

When calculating no-load power for the SiT1552, the core and output driver components need to be added. Since the output voltage swing can be programmed to minimize load current, the output driver current is variable. Therefore, no-load operating supply current is broken into two sections; core and output driver. The equation is as follows:

Total Supply Current (no load) = Idd Core + Idd Output Driver

#### **Example 1: Full-swing LVCMOS**

- Vdd = 1.8V
- Idd Core = 990nA (typ)
- Vout<sub>pp</sub> = 1.8V
- Idd Output Driver: (Cdriver)(Vout)(Fout) = (3.5pF)(1.8V)(32768Hz) = 206nA

Supply Current = 990nA + 206nA = 1.2μA

#### **Example 2: NanoDrive Reduced Swing**

- Vdd = 1.8V
- Idd Core = 990nA (typ)
- Vout<sub>pp</sub> (Programmable) = V<sub>OH</sub> - V<sub>OL</sub> = 1.1V - 0.6V = 500mV
- Idd Output Driver: (Cdriver)(Vout)(Fout) = (3.5pF)(0.50V)(32768Hz) = 57nA

Supply Current = 990nA + 57nA = 1.05μA

#### Total Supply Current with Load

To calculate the total supply current, including the load, follow the equation listed below. Note the 30% reduction in power with NanoDrive.

Total Current = Idd Core + Idd Output Driver + Load Current

#### **Example 1: Full-swing LVCMOS**

- Vdd = 1.8V
- Idd Core = 990nA
- Load Capacitance = 10pF
- Idd Output Driver: (Cdriver)(Vout)(Fout) = (3.5pF)(1.8V)(32768Hz) = 206nA
- Load Current: (10pF)(1.8V)(32768Hz) = 590nA
- Total Current = 990nA + 206nA + 590nA = 1.79μA

#### **Example 2: NanoDrive Reduced Swing**

- Vdd = 1.8V
- Idd Core = 990nA
- Load Capacitance = 10pF
- Vout<sub>pp</sub> (Programmable): V<sub>OH</sub> - V<sub>OL</sub> = 1.1V - 0.6V = 500mV
- Idd Output Driver: (Cdriver)(Vout)(Fout) = (3.5pF)(0.5V)(32768Hz) = 57nA
- Load Current: (10pF)(0.5V)(32768Hz) = 164nA
- Total Current = 990nA + 57nA + 164nA = 1.2μA

### Dimensions and Patterns

Package Size – Dimensions (Unit: mm) <sup>[3]</sup>	Recommended Land Pattern (Unit: mm)
<p><b>2.0 x 1.2 mm SMD</b></p>	
<p><b>1.55 x 0.85 mm CSP</b></p>	<p>(soldermask openings shown with heavy dashed line)</p>
<p><b>2.90 x 2.80 mm SOT23-5</b></p>	

**Note:**

3. Top marking: Y denotes manufacturing origin and XXXX denotes manufacturing lot number. The value of “Y” will depend on the assembly location of the device.

### SOT23-5 Dimension Table

Symbol	Min.	Nom.	Max.
A	0.90	1.27	1.45
A1	0.00	0.07	0.15
A2	0.90	1.2	1.30
b	0.30	0.35	0.50
c	0.14	0.153	0.20
D		2.90	

Symbol	Min.	Nom.	Max.
E		2.80	
E1		1.60	
e		0.95	
e1		1.90	
L	0.30	0.38	0.55
L1		0.25	
a	0°	–	8°



### Ordering Information

Part number characters in blue represent the customer specific options. The other characters in the part number are fixed.

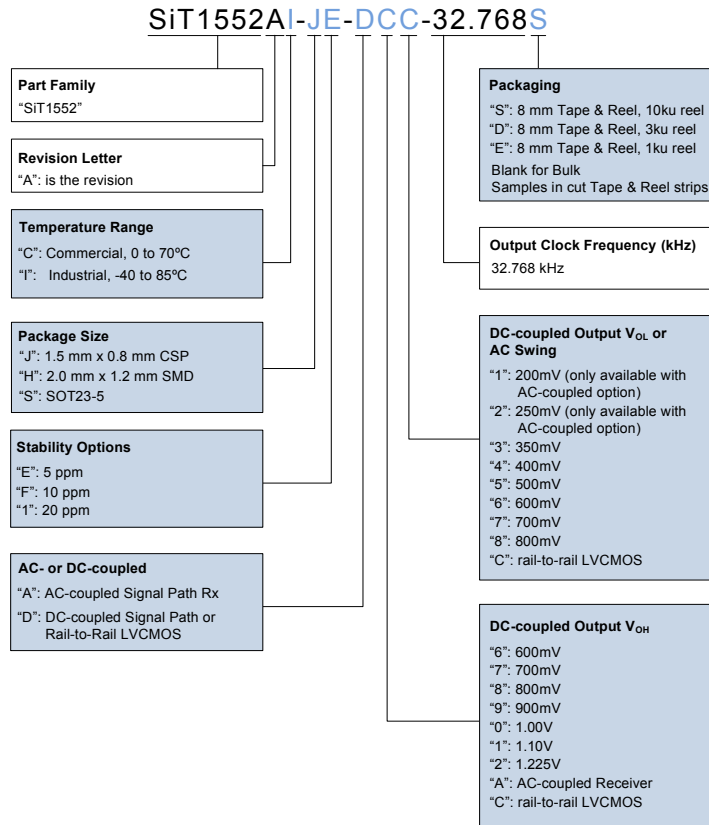

The following examples illustrate how to select the appropriate part number scheme:

**Example 1: SiT1552AI-JE-DCC-32.768**

- Industrial temperature range
- CSP package
- 5 ppm frequency stability
- Output requirements:
  - a) Output frequency = 32.768 kHz
  - b) "D" = DC-coupled receiver
  - c) "C" = LVCMOS output swing
  - d) "C" = LVCMOS output swing

**Example 2: SiT1552AI-SF-AA5-32.768**

- Industrial temperature range
- SOT23-5 package
- 10 ppm frequency stability
- Output requirements:
  - a) Output frequency = 32.768 kHz
  - b) "A" = AC-coupled receiver
  - c) "A" = AC-coupled receiver
  - d) "5" = 500mV swing

© SiTime Corporation 2014. The information contained herein is subject to change at any time without notice. SiTime assumes no responsibility or liability for any loss, damage or defect of a Product which is caused in whole or in part by (i) use of any circuitry other than circuitry embodied in a SiTime product, (ii) misuse or abuse including static discharge, neglect or accident, (iii) unauthorized modification or repairs which have been soldered or altered during assembly and are not capable of being tested by SiTime under its normal test conditions, or (iv) improper installation, storage, handling, warehousing or transportation, or (v) being subjected to unusual physical, thermal, or electrical stress.

**Disclaimer:** SiTime makes no warranty of any kind, express or implied, with regard to this material, and specifically disclaims any and all express or implied warranties, either in fact or by operation of law, statutory or otherwise, including the implied warranties of merchantability and fitness for use or a particular purpose, and any implied warranty arising from course of dealing or usage of trade, as well as any common-law duties relating to accuracy or lack of negligence, with respect to this material, any SiTime product and any product documentation. Products sold by SiTime are not suitable or intended to be used in a life support application or component, to operate nuclear facilities, or in other mission critical applications where human life may be involved or at stake. All sales are made conditioned upon compliance with the critical uses policy set forth below.

**CRITICAL USE EXCLUSION POLICY**  
BUYER AGREES NOT TO USE SITIME'S PRODUCTS FOR ANY APPLICATION OR IN ANY COMPONENTS USED IN LIFE SUPPORT DEVICES OR TO OPERATE NUCLEAR FACILITIES OR FOR USE IN OTHER MISSION-CRITICAL APPLICATIONS OR COMPONENTS WHERE HUMAN LIFE OR PROPERTY MAY BE AT STAKE.

SiTime owns all rights, title and interest to the intellectual property related to SiTime's products, including any software, firmware, copyright, patent, or trademark. The sale of SiTime products does not convey or imply any license under patent or other rights. SiTime retains the copyright and trademark rights in all documents, catalogs and plans supplied pursuant to or ancillary to the sale of products or services by SiTime. Unless otherwise agreed to in writing by SiTime, any reproduction, modification, translation, compilation, or representation of this material shall be strictly prohibited.