

AM26LS32AC, AM26LS32AI, AM26LS33AC, AM26LS32AM, AM26LS33AM QUADRUPLE DIFFERENTIAL LINE RECEIVERS

SLLS115D – OCTOBER 1980 – REVISED MARCH 2002

- **AM26LS32A Devices Meet or Exceed the Requirements of ANSI TIA/EIA-422-B, TIA/EIA-423-B, and ITU Recommendations V.10 and V.11**
- **AM26LS32A Devices Have ± 7 -V Common-Mode Range With ± 200 -mV Sensitivity**
- **AM26LS33A Devices Have ± 15 -V Common-Mode Range With ± 500 -mV Sensitivity**
- **Input Hysteresis . . . 50 mV Typical**
- **Operate From a Single 5-V Supply**
- **Low-Power Schottky Circuitry**
- **3-State Outputs**
- **Complementary Output-Enable Inputs**
- **Input Impedance . . . 12 k Ω Min**
- **Designed to Be Interchangeable With Advanced Micro Devices AM26LS32™ and AM26LS33™**

description

The AM26LS32A and AM26LS33A devices are quadruple differential line receivers for balanced and unbalanced digital data transmission. The enable function is common to all four receivers and offers a choice of active-high or active-low input. The 3-state outputs permit connection directly to a bus-organized system. Fail-safe design ensures that, if the inputs are open, the outputs always are high.

Compared to the AM26LS32 and the AM26LS33, the AM26LS32A and AM26LS33A incorporate an additional stage of amplification to improve sensitivity. The input impedance has been increased, resulting in less loading of the bus line. The additional stage has increased propagation delay; however, this does not affect interchangeability in most applications.

The AM26LS32AC and AM26LS33AC are characterized for operation from 0°C to 70°C. The AM26LS32AI is characterized for operation from -40°C to 85°C. The AM26LS32AM and AM26LS33AM are characterized for operation over the full military temperature range of -55°C to 125°C.

AM26LS32AC . . . D, N, OR NS PACKAGE
AM26LS32AI, AM26LS33AC . . . D OR N PACKAGE
AM26LS32AM, AM26LS33AM . . . J PACKAGE
(TOP VIEW)

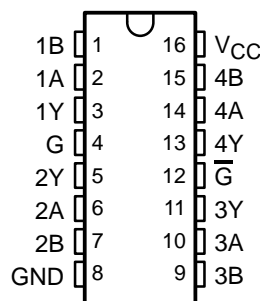

AM26LS32AM, AM26LS33AM . . . FK PACKAGE
(TOP VIEW)

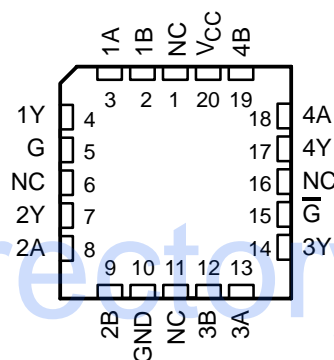

NC – No internal connection



Please be aware that an important notice concerning availability, standard warranty, and use in critical applications of Texas Instruments semiconductor products and disclaimers thereto appears at the end of this data sheet.

AM26LS32 and AM26LS33 are trademarks of Advanced Micro Devices, Inc.

PRODUCTION DATA information is current as of publication date. Products conform to specifications per the terms of Texas Instruments standard warranty. Production processing does not necessarily include testing of all parameters.

 **TEXAS
INSTRUMENTS**

POST OFFICE BOX 655303 • DALLAS, TEXAS 75265

Copyright © 2002, Texas Instruments Incorporated

**AM26LS32AC, AM26LS32AI, AM26LS33AC,
AM26LS32AM, AM26LS33AM
QUADRUPLE DIFFERENTIAL LINE RECEIVERS**

SLLS115D – OCTOBER 1980 – REVISED MARCH 2002

FUNCTION TABLE
(each receiver)

DIFFERENTIAL A – B	ENABLES		OUTPUT Y
	G	\overline{G}	
$V_{ID} \geq V_{IT+}$	H	X	H
	X	L	H
$V_{IT-} \leq V_{ID} \leq V_{IT+}$	H	X	?
	X	L	?
$V_{ID} \leq V_{IT-}$	H	X	L
	X	L	L
X	L	H	Z
Open	H	X	H
	X	L	H

H = high level, L = low level, ? = indeterminate,
X = irrelevant, Z = high impedance (off)

logic diagram (positive logic)

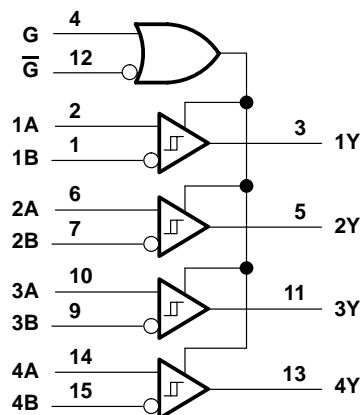

AM26LS32AC, AM26LS32AI, AM26LS33AC, AM26LS32AM, AM26LS33AM QUADRUPLE DIFFERENTIAL LINE RECEIVERS

SLLS115D – OCTOBER 1980 – REVISED MARCH 2002

schematics of inputs and outputs

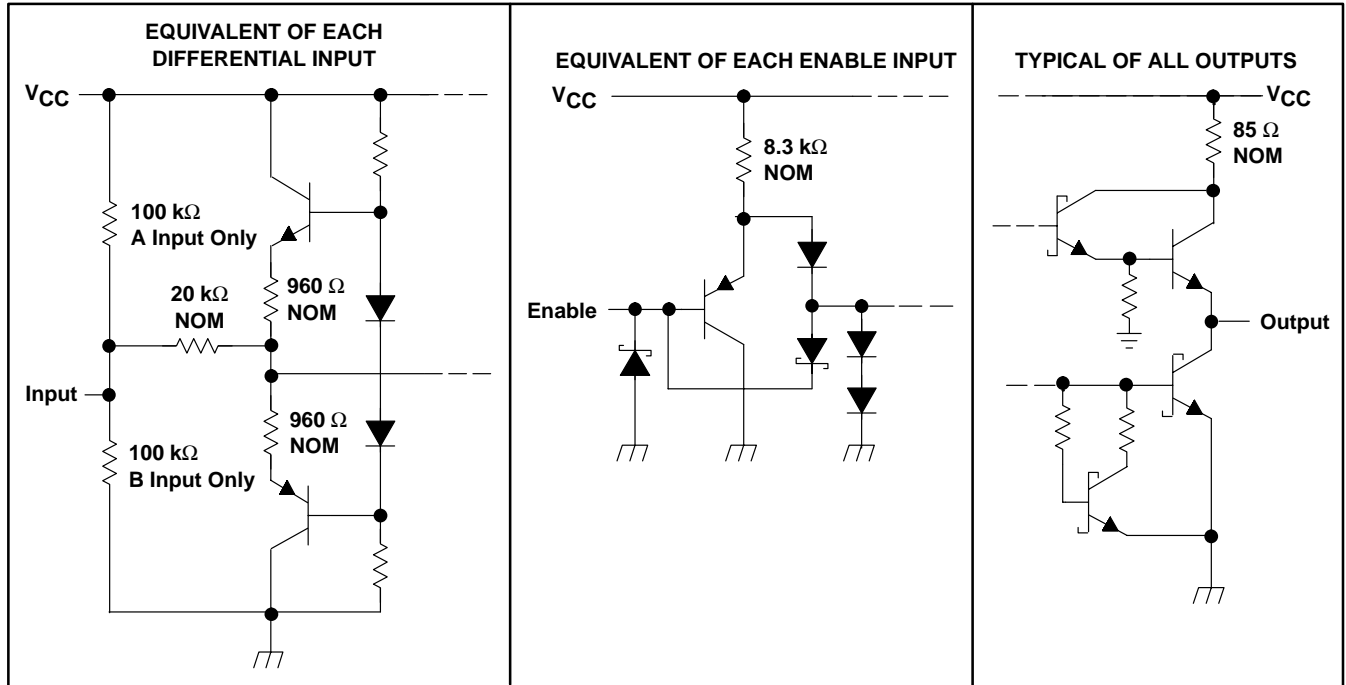

absolute maximum ratings over operating free-air temperature range (unless otherwise noted)†

Supply voltage, V_{CC} (see Note 1)	7 V
Input voltage, V_I : Any differential input	± 25 V
Other inputs	7 V
Differential input voltage, V_{ID} (see Note 2)	± 25 V
Continuous total power dissipation	See Dissipation Rating Table
Package thermal impedance, θ_{JA} (see Note 3): D package	73°C/W
N package	67°C/W
NS package	64°C/W
Case temperature for 60 seconds, T_C : FK package	260°C
Lead temperature 1,6 mm (1/16 inch) from case for 10 seconds: D or N package	260°C
Lead temperature 1,6 mm (1/16 inch) from case for 60 seconds: J package	300°C
Storage temperature range, T_{stg}	-65°C to 150°C

† Stresses beyond those listed under "absolute maximum ratings" may cause permanent damage to the device. These are stress ratings only, and functional operation of the device at these or any other conditions beyond those indicated under "recommended operating conditions" is not implied. Exposure to absolute-maximum-rated conditions for extended periods may affect device reliability.

- NOTES: 1. All voltage values, except differential voltages, are with respect to the network ground terminal.
 2. Differential voltage values are at the noninverting (A) input terminals with respect to the inverting (B) input terminals.
 3. The package thermal impedance is calculated in accordance with JESD 51-7.

DISSIPATION RATING TABLE

PACKAGE	$T_A \leq 25^\circ\text{C}$ POWER RATING	DERATING FACTOR ABOVE $T_A = 25^\circ\text{C}$	$T_A = 70^\circ\text{C}$ POWER RATING	$T_A = 125^\circ\text{C}$ POWER RATING
FK	1375 mW	11.0 mW/°C	880 mW	275 mW
J	1375 mW	11.0 mW/°C	880 mW	275 mW

AM26LS32AC, AM26LS32AI, AM26LS33AC, AM26LS32AM, AM26LS33AM QUADRUPLE DIFFERENTIAL LINE RECEIVERS

SLLS115D – OCTOBER 1980 – REVISED MARCH 2002

recommended operating conditions

		MIN	NOM	MAX	UNIT		
V _{CC}	Supply voltage	AM26LS32AC, AM26LS32AI, AM26LS33AC		4.75	5	5.25	V
		AM26LS32AM, AM26LS33AM		4.5	5	5.5	
V _{IH}	High-level input voltage	2				V	
V _{IL}	Low-level input voltage				0.8	V	
V _{IC}	Common-mode input voltage	AM26LS32A		±7		V	
		AM26LS33A		±15			
I _{OH}	High-level output current				-440	μA	
I _{OL}	Low-level output current				8	mA	
T _A	Operating free-air temperature	AM26LS32AC, AM26LS33AC		0	70	°C	
		AM26LS32AI		-40	85		
		AM26LS32AM, AM26LS33AM		-55	125		

electrical characteristics over recommended ranges of V_{CC}, V_{IC}, and operating free-air temperature (unless otherwise noted)

PARAMETER	TEST CONDITIONS		MIN	TYP†	MAX	UNIT	
V _{IT+}	Positive-going input threshold voltage	V _O = V _{OHmin} , I _{OH} = -440 μA	AM26LS32A		0.2	V	
			AM26LS33A		0.5		
V _{IT-}	Negative-going input threshold voltage	V _O = 0.45 V, I _{OL} = 8 mA	AM26LS32A		-0.2‡	V	
			AM26LS33A		-0.5‡		
V _{hys}	Hysteresis voltage (V _{IT+} - V _{IT-})		50			mV	
V _{IK}	Enable-input clamp voltage	V _{CC} = MIN, I _I = -18 mA			-1.5	V	
V _{OH}	High-level output voltage	V _{CC} = MIN, V _{ID} = 1 V, V _{I(G)} = 0.8 V, I _{OH} = -440 μA	AM26LS32AC AM26LS33AC		2.7	V	
			AM26LS32AM, AM26LS32AI, AM26LS33AM		2.5		
V _{OL}	Low-level output voltage	V _{CC} = MIN, V _{ID} = -1 V, V _{I(G)} = 0.8 V	I _{OL} = 4 mA		0.4	V	
			I _{OL} = 8 mA		0.45		
I _{OZ}	Off-state (high-impedance state) output current	V _{CC} = MAX	V _O = 2.4 V		20	μA	
			V _O = 0.4 V		-20		
I _I	Line input current	V _I = 15 V, Other input at -10 V to 15 V			1.2	mA	
		V _I = -15 V, Other input at -15 V to 10 V			-1.7		
I _{I(EN)}	Enable input current	V _I = 5.5 V			100	μA	
I _{IH}	High-level enable current	V _I = 2.7 V			20	μA	
I _{IL}	Low-level enable current	V _I = 0.4 V			-0.36	mA	
r _I	Input resistance	V _{IC} = -15 V to 15 V, One input to ac ground	12	15		kΩ	
I _{OS}	Short-circuit output current§	V _{CC} = MAX	-15		-85	mA	
I _{CC}	Supply current	V _{CC} = MAX, All outputs disabled			52	70	mA

† All typical values are at V_{CC} = 5 V, T_A = 25°C, and V_{IC} = 0.

‡ The algebraic convention, in which the less positive (more negative) limit is designated as minimum, is used in this data sheet for threshold levels only.

§ Not more than one output should be shorted to ground at a time, and duration of the short circuit should not exceed one second.



AM26LS32AC, AM26LS32AI, AM26LS33AC, AM26LS32AM, AM26LS33AM QUADRUPLE DIFFERENTIAL LINE RECEIVERS

SLLS115D – OCTOBER 1980 – REVISED MARCH 2002

switching characteristics, $V_{CC} = 5\text{ V}$, $T_A = 25^\circ\text{C}$

PARAMETER	TEST CONDITIONS	MIN	TYP	MAX	UNIT
t_{PLH} Propagation delay time, low-to-high-level output	$C_L = 15\text{ pF}$, See Figure 1		20	35	ns
t_{PHL} Propagation delay time, high-to-low-level output			22	35	
t_{PZH} Output enable time to high level	$C_L = 15\text{ pF}$, See Figure 1		17	22	ns
t_{PZL} Output enable time to low level			20	25	
t_{PHZ} Output disable time from high level	$C_L = 5\text{ pF}$, See Figure 1		21	30	ns
t_{PLZ} Output disable time from low level			30	40	

PARAMETER MEASUREMENT INFORMATION

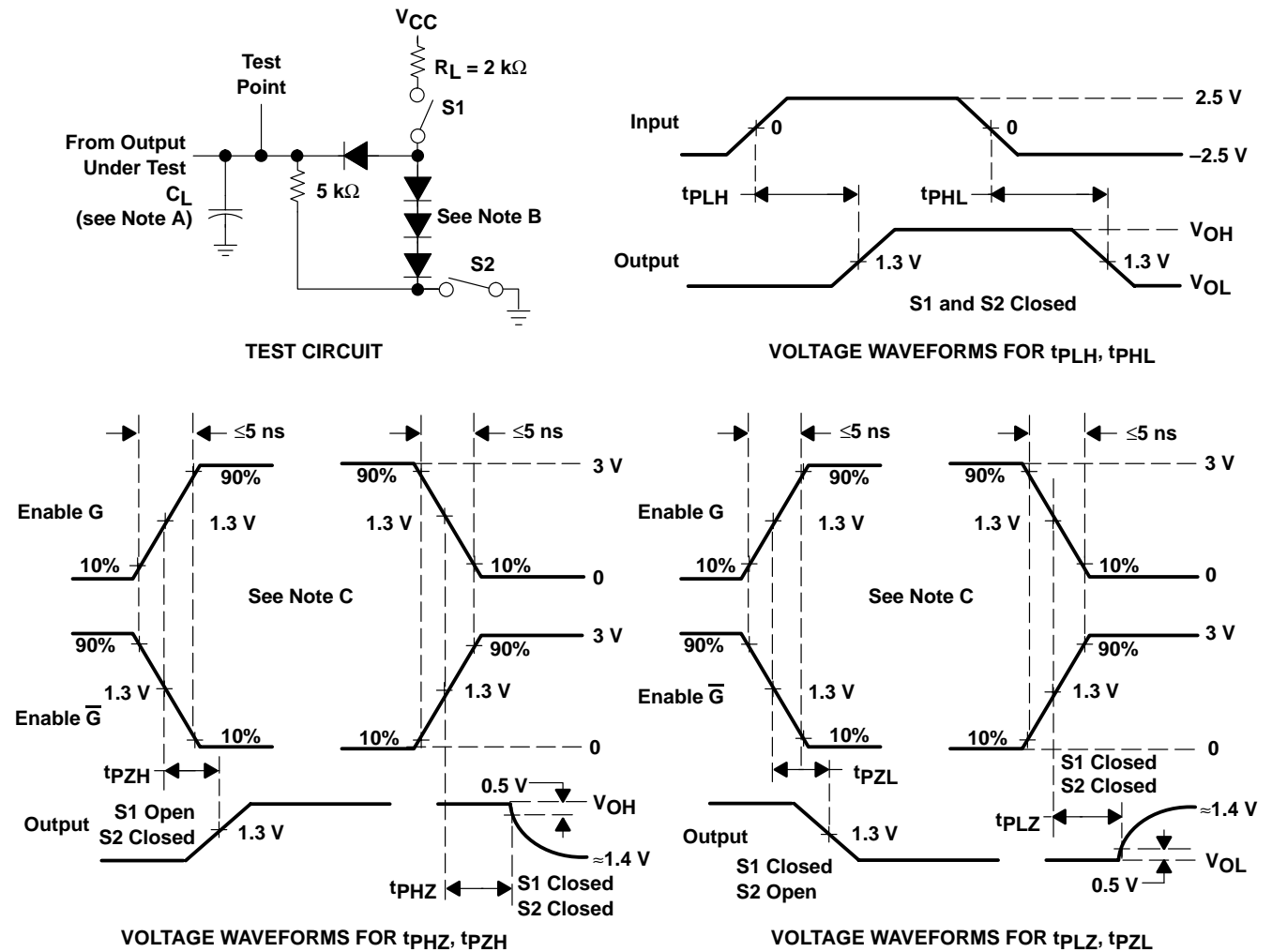

- NOTES: A. C_L includes probe and jig capacitance.
 B. All diodes are 1N3064 or equivalent.
 C. Enable G is tested with \bar{G} high; \bar{G} is tested with G low.

Figure 1

**AM26LS32AC, AM26LS32AI, AM26LS33AC,
AM26LS32AM, AM26LS33AM
QUADRUPLE DIFFERENTIAL LINE RECEIVERS**

SLLS115D – OCTOBER 1980 – REVISED MARCH 2002

TYPICAL CHARACTERISTICS

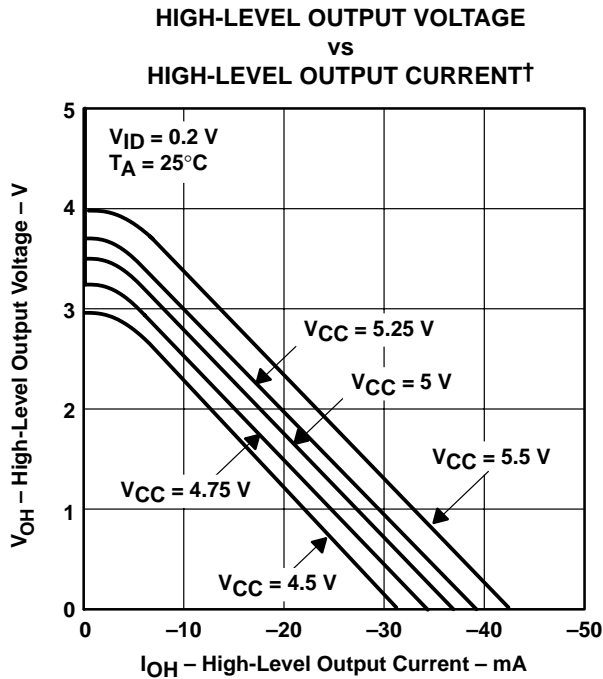

Figure 2

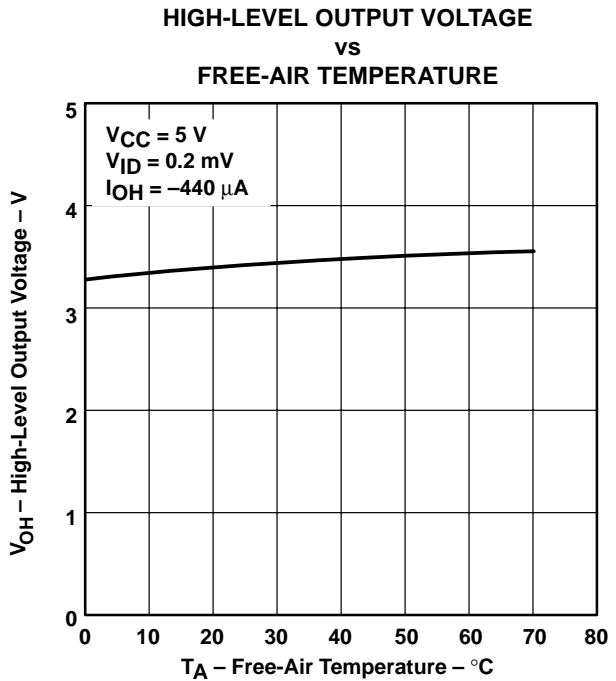

Figure 3

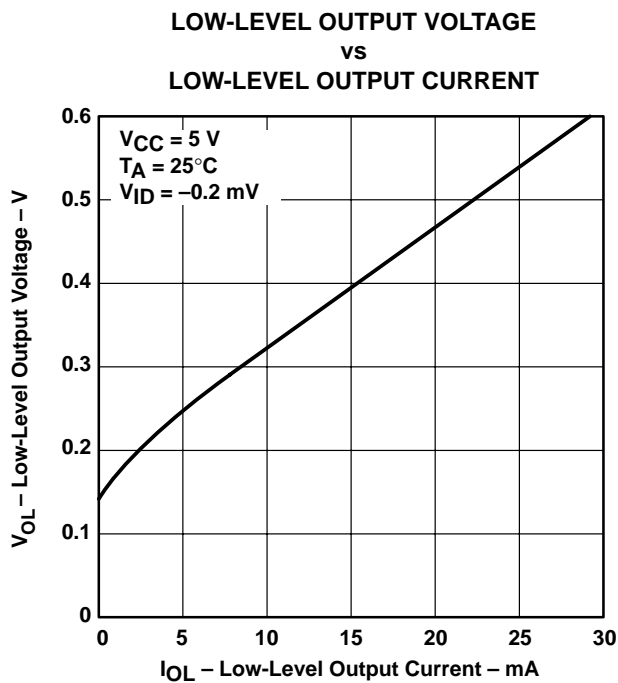

Figure 4

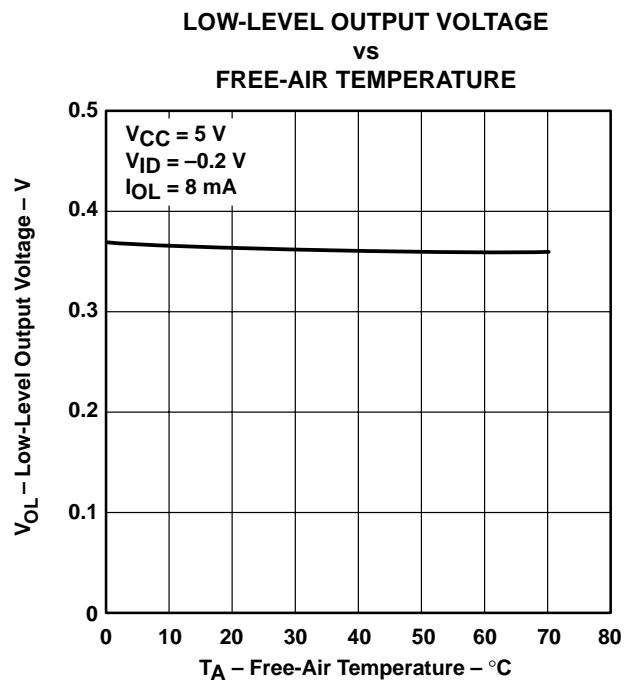

Figure 5



TYPICAL CHARACTERISTICS

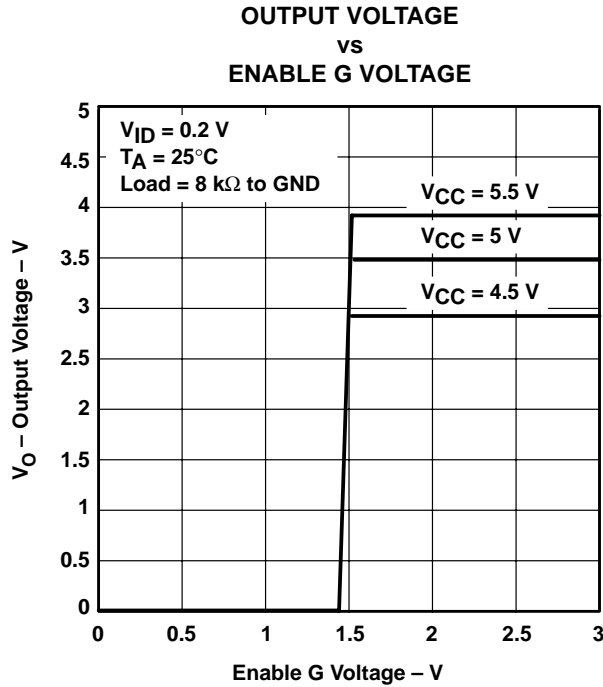

Figure 6

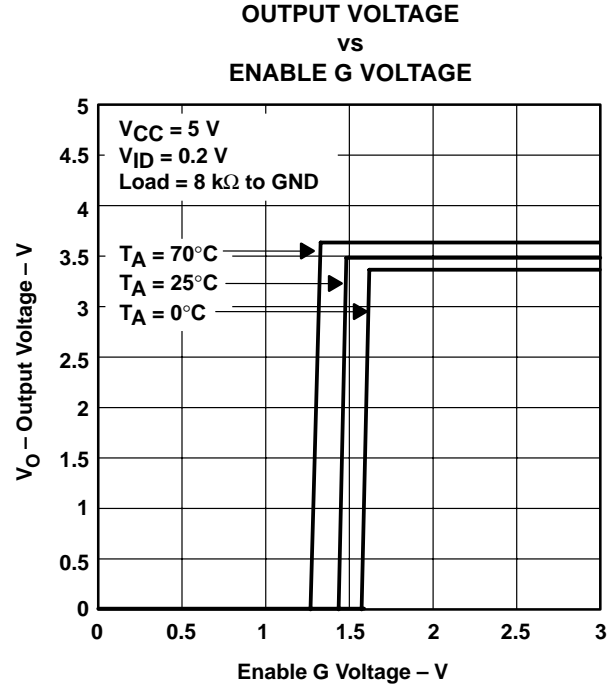

Figure 7

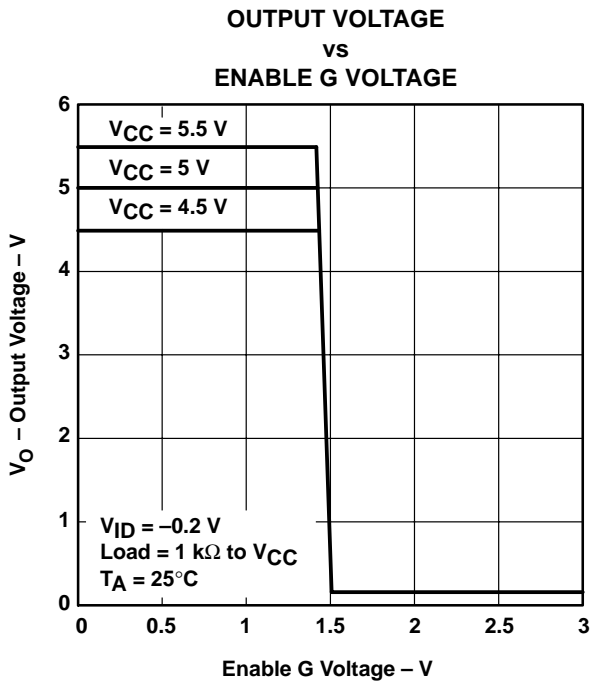

Figure 8

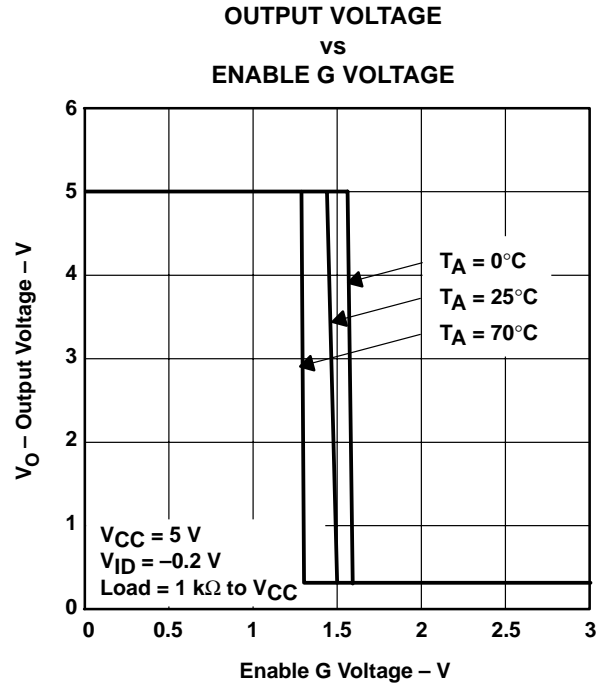

Figure 9

**AM26LS32AC, AM26LS32AI, AM26LS33AC,
AM26LS32AM, AM26LS33AM
QUADRUPLE DIFFERENTIAL LINE RECEIVERS**

SLLS115D – OCTOBER 1980 – REVISED MARCH 2002

TYPICAL CHARACTERISTICS

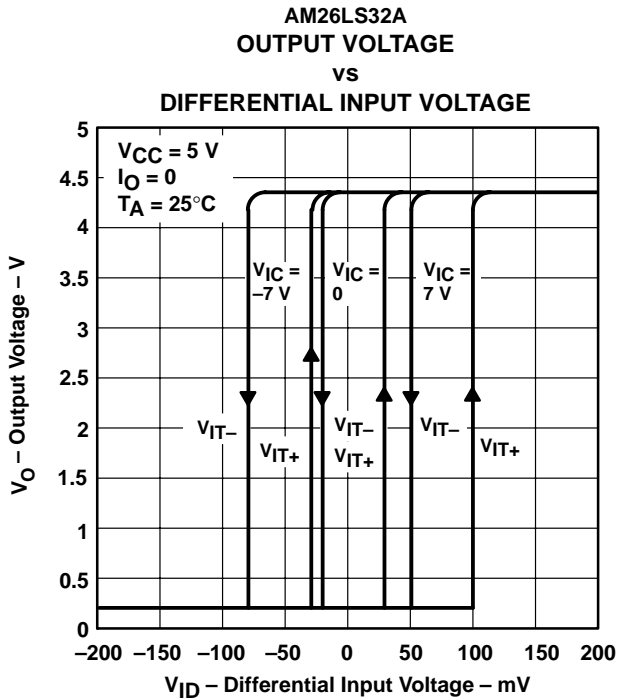

Figure 10

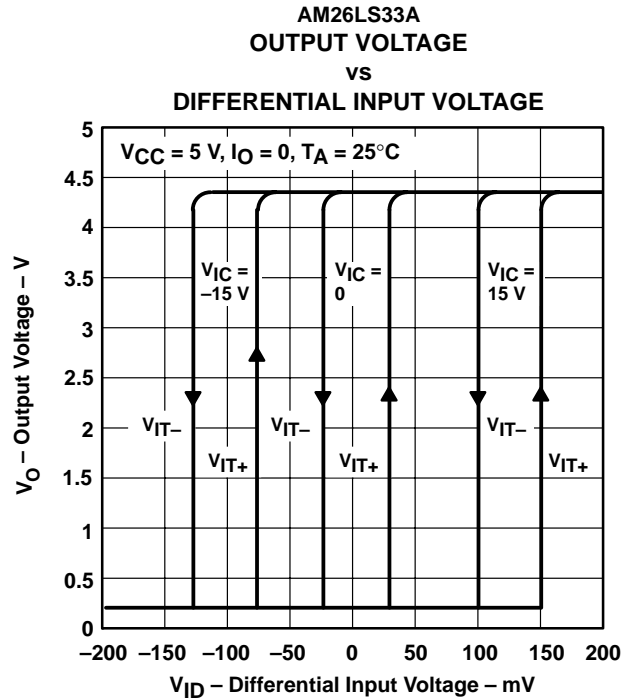

Figure 11

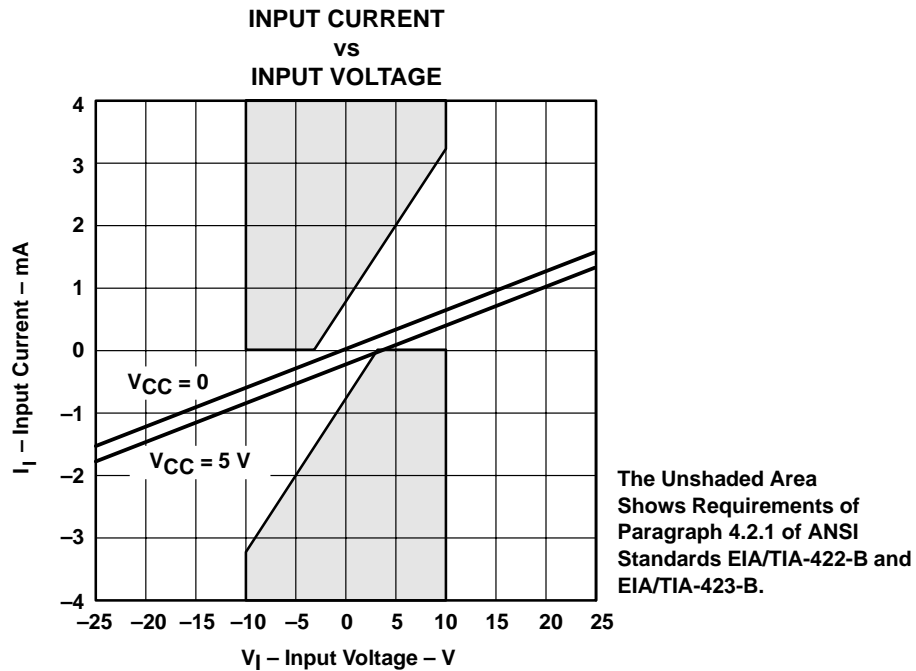
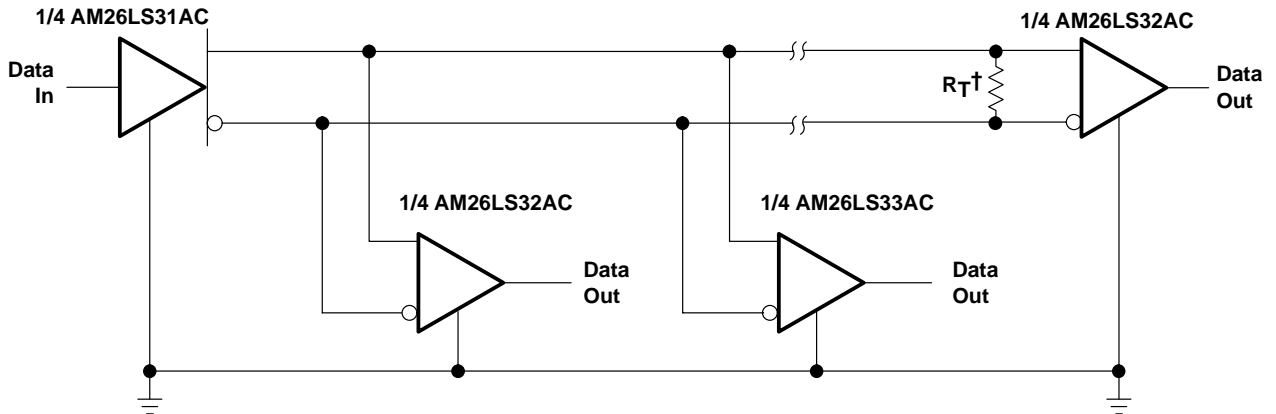

Figure 12



APPLICATION INFORMATION



† R_T equals the characteristic impedance of the line.

Figure 13. Circuit With Multiple Receivers

IMPORTANT NOTICE

Texas Instruments Incorporated and its subsidiaries (TI) reserve the right to make corrections, modifications, enhancements, improvements, and other changes to its products and services at any time and to discontinue any product or service without notice. Customers should obtain the latest relevant information before placing orders and should verify that such information is current and complete. All products are sold subject to TI's terms and conditions of sale supplied at the time of order acknowledgment.

TI warrants performance of its hardware products to the specifications applicable at the time of sale in accordance with TI's standard warranty. Testing and other quality control techniques are used to the extent TI deems necessary to support this warranty. Except where mandated by government requirements, testing of all parameters of each product is not necessarily performed.

TI assumes no liability for applications assistance or customer product design. Customers are responsible for their products and applications using TI components. To minimize the risks associated with customer products and applications, customers should provide adequate design and operating safeguards.

TI does not warrant or represent that any license, either express or implied, is granted under any TI patent right, copyright, mask work right, or other TI intellectual property right relating to any combination, machine, or process in which TI products or services are used. Information published by TI regarding third-party products or services does not constitute a license from TI to use such products or services or a warranty or endorsement thereof. Use of such information may require a license from a third party under the patents or other intellectual property of the third party, or a license from TI under the patents or other intellectual property of TI.

Reproduction of information in TI data books or data sheets is permissible only if reproduction is without alteration and is accompanied by all associated warranties, conditions, limitations, and notices. Reproduction of this information with alteration is an unfair and deceptive business practice. TI is not responsible or liable for such altered documentation.

Resale of TI products or services with statements different from or beyond the parameters stated by TI for that product or service voids all express and any implied warranties for the associated TI product or service and is an unfair and deceptive business practice. TI is not responsible or liable for any such statements.

TI products are not authorized for use in safety-critical applications (such as life support) where a failure of the TI product would reasonably be expected to cause severe personal injury or death, unless officers of the parties have executed an agreement specifically governing such use. Buyers represent that they have all necessary expertise in the safety and regulatory ramifications of their applications, and acknowledge and agree that they are solely responsible for all legal, regulatory and safety-related requirements concerning their products and any use of TI products in such safety-critical applications, notwithstanding any applications-related information or support that may be provided by TI. Further, Buyers must fully indemnify TI and its representatives against any damages arising out of the use of TI products in such safety-critical applications.

TI products are neither designed nor intended for use in military/aerospace applications or environments unless the TI products are specifically designated by TI as military-grade or "enhanced plastic." Only products designated by TI as military-grade meet military specifications. Buyers acknowledge and agree that any such use of TI products which TI has not designated as military-grade is solely at the Buyer's risk, and that they are solely responsible for compliance with all legal and regulatory requirements in connection with such use.

TI products are neither designed nor intended for use in automotive applications or environments unless the specific TI products are designated by TI as compliant with ISO/TS 16949 requirements. Buyers acknowledge and agree that, if they use any non-designated products in automotive applications, TI will not be responsible for any failure to meet such requirements.

Following are URLs where you can obtain information on other Texas Instruments products and application solutions:

Products		Applications	
Amplifiers	amplifier.ti.com	Audio	www.ti.com/audio
Data Converters	dataconverter.ti.com	Automotive	www.ti.com/automotive
DSP	dsp.ti.com	Broadband	www.ti.com/broadband
Interface	interface.ti.com	Digital Control	www.ti.com/digitalcontrol
Logic	logic.ti.com	Military	www.ti.com/military
Power Mgmt	power.ti.com	Optical Networking	www.ti.com/opticalnetwork
Microcontrollers	microcontroller.ti.com	Security	www.ti.com/security
Low Power Wireless	www.ti.com/lpw	Telephony	www.ti.com/telephony
		Video & Imaging	www.ti.com/video
		Wireless	www.ti.com/wireless

Mailing Address: Texas Instruments, Post Office Box 655303, Dallas, Texas 75265
Copyright © 2007, Texas Instruments Incorporated

PACKAGING INFORMATION

Orderable Device	Status ⁽¹⁾	Package Type	Package Drawing	Pins	Package Qty	Eco Plan ⁽²⁾	Lead/Ball Finish	MSL Peak Temp ⁽³⁾
5962-7802003M2A	ACTIVE	LCCC	FK	20	1	TBD	POST-PLATE	N / A for Pkg Type
5962-7802003MEA	ACTIVE	CDIP	J	16	1	TBD	A42 SNPB	N / A for Pkg Type
5962-7802003MFA	ACTIVE	CFP	W	16	1	TBD	A42 SNPB	N / A for Pkg Type
5962-7802004M2A	ACTIVE	LCCC	FK	20	1	TBD	POST-PLATE	N / A for Pkg Type
5962-7802004MEA	ACTIVE	CDIP	J	16	1	TBD	A42 SNPB	N / A for Pkg Type
5962-7802004MFA	ACTIVE	CFP	W	16	1	TBD	A42 SNPB	N / A for Pkg Type
AM26LS32ACD	ACTIVE	SOIC	D	16	40	Green (RoHS & no Sb/Br)	CU NIPDAU	Level-1-260C-UNLIM
AM26LS32ACDE4	ACTIVE	SOIC	D	16	40	Green (RoHS & no Sb/Br)	CU NIPDAU	Level-1-260C-UNLIM
AM26LS32ACDG4	ACTIVE	SOIC	D	16	40	Green (RoHS & no Sb/Br)	CU NIPDAU	Level-1-260C-UNLIM
AM26LS32ACDR	ACTIVE	SOIC	D	16	2500	Green (RoHS & no Sb/Br)	CU NIPDAU	Level-1-260C-UNLIM
AM26LS32ACDRE4	ACTIVE	SOIC	D	16	2500	Green (RoHS & no Sb/Br)	CU NIPDAU	Level-1-260C-UNLIM
AM26LS32ACDRG4	ACTIVE	SOIC	D	16	2500	Green (RoHS & no Sb/Br)	CU NIPDAU	Level-1-260C-UNLIM
AM26LS32ACN	ACTIVE	PDIP	N	16	25	Pb-Free (RoHS)	CU NIPDAU	N / A for Pkg Type
AM26LS32ACNE4	ACTIVE	PDIP	N	16	25	Pb-Free (RoHS)	CU NIPDAU	N / A for Pkg Type
AM26LS32ACNSR	ACTIVE	SO	NS	16	2000	Green (RoHS & no Sb/Br)	CU NIPDAU	Level-1-260C-UNLIM
AM26LS32ACNSRG4	ACTIVE	SO	NS	16	2000	Green (RoHS & no Sb/Br)	CU NIPDAU	Level-1-260C-UNLIM
AM26LS32ACPW	ACTIVE	TSSOP	PW	16	90	Green (RoHS & no Sb/Br)	CU NIPDAU	Level-1-260C-UNLIM
AM26LS32ACPWE4	ACTIVE	TSSOP	PW	16	90	Green (RoHS & no Sb/Br)	CU NIPDAU	Level-1-260C-UNLIM
AM26LS32ACPWG4	ACTIVE	TSSOP	PW	16	90	Green (RoHS & no Sb/Br)	CU NIPDAU	Level-1-260C-UNLIM
AM26LS32ACPWR	ACTIVE	TSSOP	PW	16	2000	Green (RoHS & no Sb/Br)	CU NIPDAU	Level-1-260C-UNLIM
AM26LS32ACPWRE4	ACTIVE	TSSOP	PW	16	2000	Green (RoHS & no Sb/Br)	CU NIPDAU	Level-1-260C-UNLIM
AM26LS32ACPWG4	ACTIVE	TSSOP	PW	16	2000	Green (RoHS & no Sb/Br)	CU NIPDAU	Level-1-260C-UNLIM
AM26LS32AID	ACTIVE	SOIC	D	16	40	Green (RoHS & no Sb/Br)	CU NIPDAU	Level-1-260C-UNLIM
AM26LS32AIDE4	ACTIVE	SOIC	D	16	40	Green (RoHS & no Sb/Br)	CU NIPDAU	Level-1-260C-UNLIM
AM26LS32AIDG4	ACTIVE	SOIC	D	16	40	Green (RoHS & no Sb/Br)	CU NIPDAU	Level-1-260C-UNLIM
AM26LS32AIDR	ACTIVE	SOIC	D	16	2500	Green (RoHS & no Sb/Br)	CU NIPDAU	Level-1-260C-UNLIM
AM26LS32AIDRE4	ACTIVE	SOIC	D	16	2500	Green (RoHS & no Sb/Br)	CU NIPDAU	Level-1-260C-UNLIM

Orderable Device	Status ⁽¹⁾	Package Type	Package Drawing	Pins	Package Qty	Eco Plan ⁽²⁾	Lead/Ball Finish	MSL Peak Temp ⁽³⁾
AM26LS32AIDRG4	ACTIVE	SOIC	D	16	2500	Green (RoHS & no Sb/Br)	CU NIPDAU	Level-1-260C-UNLIM
AM26LS32AIN	ACTIVE	PDIP	N	16	25	Pb-Free (RoHS)	CU NIPDAU	N / A for Pkg Type
AM26LS32AINE4	ACTIVE	PDIP	N	16	25	Pb-Free (RoHS)	CU NIPDAU	N / A for Pkg Type
AM26LS32AMFKB	ACTIVE	LCCC	FK	20	1	TBD	POST-PLATE	N / A for Pkg Type
AM26LS32AMJ	ACTIVE	CDIP	J	16	1	TBD	A42 SNPB	N / A for Pkg Type
AM26LS32AMJB	ACTIVE	CDIP	J	16	1	TBD	A42 SNPB	N / A for Pkg Type
AM26LS32AMWB	ACTIVE	CFP	W	16	1	TBD	A42 SNPB	N / A for Pkg Type
AM26LS33ACD	ACTIVE	SOIC	D	16	40	Green (RoHS & no Sb/Br)	CU NIPDAU	Level-1-260C-UNLIM
AM26LS33ACDE4	ACTIVE	SOIC	D	16	40	Green (RoHS & no Sb/Br)	CU NIPDAU	Level-1-260C-UNLIM
AM26LS33ACDG4	ACTIVE	SOIC	D	16	40	Green (RoHS & no Sb/Br)	CU NIPDAU	Level-1-260C-UNLIM
AM26LS33ACDR	ACTIVE	SOIC	D	16	2500	Green (RoHS & no Sb/Br)	CU NIPDAU	Level-1-260C-UNLIM
AM26LS33ACDRE4	ACTIVE	SOIC	D	16	2500	Green (RoHS & no Sb/Br)	CU NIPDAU	Level-1-260C-UNLIM
AM26LS33ACDRG4	ACTIVE	SOIC	D	16	2500	Green (RoHS & no Sb/Br)	CU NIPDAU	Level-1-260C-UNLIM
AM26LS33ACN	ACTIVE	PDIP	N	16	25	Pb-Free (RoHS)	CU NIPDAU	N / A for Pkg Type
AM26LS33ACNE4	ACTIVE	PDIP	N	16	25	Pb-Free (RoHS)	CU NIPDAU	N / A for Pkg Type
AM26LS33AMFKB	ACTIVE	LCCC	FK	20	1	TBD	POST-PLATE	N / A for Pkg Type
AM26LS33AMJ	ACTIVE	CDIP	J	16	1	TBD	A42 SNPB	N / A for Pkg Type
AM26LS33AMJB	ACTIVE	CDIP	J	16	1	TBD	A42 SNPB	N / A for Pkg Type
AM26LS33AMWB	ACTIVE	CFP	W	16	1	TBD	A42 SNPB	N / A for Pkg Type

⁽¹⁾ The marketing status values are defined as follows:

ACTIVE: Product device recommended for new designs.

LIFEBUY: TI has announced that the device will be discontinued, and a lifetime-buy period is in effect.

NRND: Not recommended for new designs. Device is in production to support existing customers, but TI does not recommend using this part in a new design.

PREVIEW: Device has been announced but is not in production. Samples may or may not be available.

OBSELETE: TI has discontinued the production of the device.

⁽²⁾ Eco Plan - The planned eco-friendly classification: Pb-Free (RoHS), Pb-Free (RoHS Exempt), or Green (RoHS & no Sb/Br) - please check <http://www.ti.com/productcontent> for the latest availability information and additional product content details.

TBD: The Pb-Free/Green conversion plan has not been defined.

Pb-Free (RoHS): TI's terms "Lead-Free" or "Pb-Free" mean semiconductor products that are compatible with the current RoHS requirements for all 6 substances, including the requirement that lead not exceed 0.1% by weight in homogeneous materials. Where designed to be soldered at high temperatures, TI Pb-Free products are suitable for use in specified lead-free processes.

Pb-Free (RoHS Exempt): This component has a RoHS exemption for either 1) lead-based flip-chip solder bumps used between the die and package, or 2) lead-based die adhesive used between the die and leadframe. The component is otherwise considered Pb-Free (RoHS compatible) as defined above.

Green (RoHS & no Sb/Br): TI defines "Green" to mean Pb-Free (RoHS compatible), and free of Bromine (Br) and Antimony (Sb) based flame retardants (Br or Sb do not exceed 0.1% by weight in homogeneous material)

⁽³⁾ MSL, Peak Temp. -- The Moisture Sensitivity Level rating according to the JEDEC industry standard classifications, and peak solder temperature.

Important Information and Disclaimer:The information provided on this page represents TI's knowledge and belief as of the date that it is provided. TI bases its knowledge and belief on information provided by third parties, and makes no representation or warranty as to the accuracy of such information. Efforts are underway to better integrate information from third parties. TI has taken and continues to take reasonable steps to provide representative and accurate information but may not have conducted destructive testing or chemical analysis on incoming materials and chemicals. TI and TI suppliers consider certain information to be proprietary, and thus CAS numbers and other limited information may not be available for release.

In no event shall TI's liability arising out of such information exceed the total purchase price of the TI part(s) at issue in this document sold by TI to Customer on an annual basis.

TAPE AND REEL BOX INFORMATION

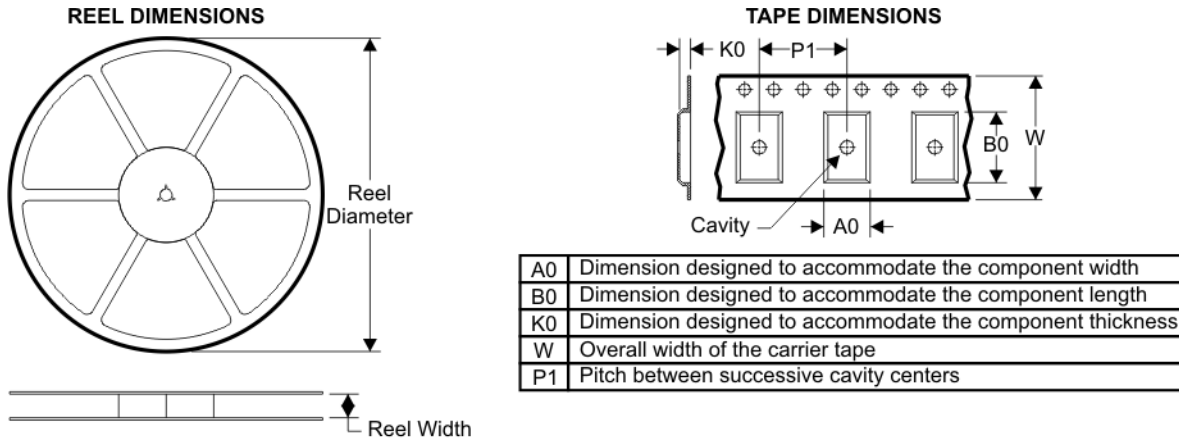

QUADRANT ASSIGNMENTS FOR PIN 1 ORIENTATION IN TAPE

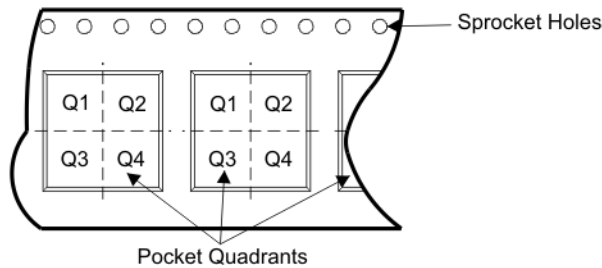

Device	Package	Pins	Site	Reel Diameter (mm)	Reel Width (mm)	A0 (mm)	B0 (mm)	K0 (mm)	P1 (mm)	W (mm)	Pin1 Quadrant
AM26LS32ACDR	D	16	SITE 27	330	16	6.5	10.3	2.1	8	16	Q1
AM26LS32ACDR	D	16	SITE 41	330	16	6.5	10.3	2.1	8	16	Q1
AM26LS32ACNSR	NS	16	SITE 41	330	16	8.2	10.5	2.5	12	16	Q1
AM26LS32ACPWR	PW	16	SITE 41	330	12	7.0	5.6	1.6	8	12	Q1
AM26LS32AIDR	D	16	SITE 27	330	16	6.5	10.3	2.1	8	16	Q1
AM26LS33ACDR	D	16	SITE 27	330	16	6.5	10.3	2.1	8	16	Q1

TAPE AND REEL BOX DIMENSIONS



Device	Package	Pins	Site	Length (mm)	Width (mm)	Height (mm)
AM26LS32ACDR	D	16	SITE 27	342.9	336.6	28.58
AM26LS32ACDR	D	16	SITE 41	346.0	346.0	33.0
AM26LS32ACNSR	NS	16	SITE 41	346.0	346.0	33.0
AM26LS32ACPWR	PW	16	SITE 41	346.0	346.0	29.0
AM26LS32AIDR	D	16	SITE 27	342.9	336.6	28.58
AM26LS33ACDR	D	16	SITE 27	342.9	336.6	28.58

J (R-GDIP-T**)

14 LEADS SHOWN

CERAMIC DUAL IN-LINE PACKAGE



DIM \ PINS **	14	16	18	20
A	0.300 (7,62) BSC	0.300 (7,62) BSC	0.300 (7,62) BSC	0.300 (7,62) BSC
B MAX	0.785 (19,94)	.840 (21,34)	0.960 (24,38)	1.060 (26,92)
B MIN	—	—	—	—
C MAX	0.300 (7,62)	0.300 (7,62)	0.310 (7,87)	0.300 (7,62)
C MIN	0.245 (6,22)	0.245 (6,22)	0.220 (5,59)	0.245 (6,22)



4040083/F 03/03

- NOTES:
- All linear dimensions are in inches (millimeters).
 - This drawing is subject to change without notice.
 - This package is hermetically sealed with a ceramic lid using glass frit.
 - Index point is provided on cap for terminal identification only on press ceramic glass frit seal only.
 - Falls within MIL STD 1835 GDIP1-T14, GDIP1-T16, GDIP1-T18 and GDIP1-T20.

W (R-GDFP-F16)

CERAMIC DUAL FLATPACK



4040180-3/D 07/03

- NOTES:
- A. All linear dimensions are in inches (millimeters).
 - B. This drawing is subject to change without notice.
 - C. This package can be hermetically sealed with a ceramic lid using glass frit.
 - D. Index point is provided on cap for terminal identification only.
 - E. Falls within MIL STD 1835 GDFP1-F16 and JEDEC MO-092AC

FK (S-CQCC-N**)

LEADLESS CERAMIC CHIP CARRIER

28 TERMINAL SHOWN



4040140/D 10/96

- NOTES:
- A. All linear dimensions are in inches (millimeters).
 - B. This drawing is subject to change without notice.
 - C. This package can be hermetically sealed with a metal lid.
 - D. The terminals are gold plated.
 - E. Falls within JEDEC MS-004

N (R-PDIP-T**)

PLASTIC DUAL-IN-LINE PACKAGE

16 PINS SHOWN



- NOTES:
- A. All linear dimensions are in inches (millimeters).
 - B. This drawing is subject to change without notice.
 - Falls within JEDEC MS-001, except 18 and 20 pin minimum body length (Dim A).
 - The 20 pin end lead shoulder width is a vendor option, either half or full width.

D (R-PDSO-G16)

PLASTIC SMALL-OUTLINE PACKAGE

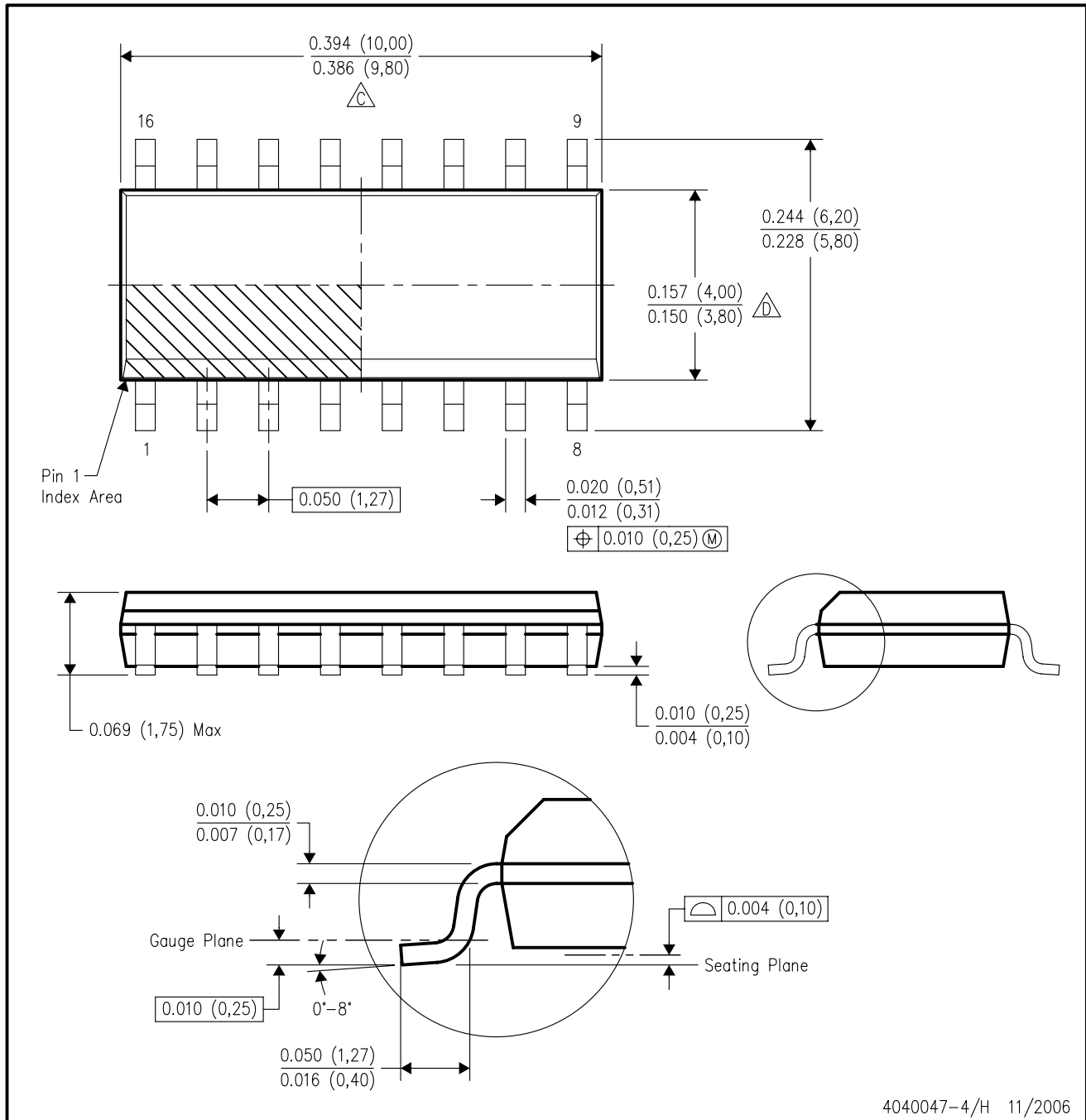

4040047-4/H 11/2006

- NOTES:
- A. All linear dimensions are in inches (millimeters).
 - B. This drawing is subject to change without notice.
 - C. Body length does not include mold flash, protrusions, or gate burrs. Mold flash, protrusions, or gate burrs shall not exceed .006 (0,15) per end.
 - D. Body width does not include interlead flash. Interlead flash shall not exceed .017 (0,43) per side.
 - E. Reference JEDEC MS-012 variation AC.

MECHANICAL DATA

NS (R-PDSO-G**)

PLASTIC SMALL-OUTLINE PACKAGE

14-PINS SHOWN



- NOTES:
- A. All linear dimensions are in millimeters.
 - B. This drawing is subject to change without notice.
 - C. Body dimensions do not include mold flash or protrusion, not to exceed 0,15.

PW (R-PDSO-G**)

PLASTIC SMALL-OUTLINE PACKAGE

14 PINS SHOWN



4040064/F 01/97

- NOTES: A. All linear dimensions are in millimeters.
 B. This drawing is subject to change without notice.
 C. Body dimensions do not include mold flash or protrusion not to exceed 0,15.
 D. Falls within JEDEC MO-153

IMPORTANT NOTICE

Texas Instruments Incorporated and its subsidiaries (TI) reserve the right to make corrections, modifications, enhancements, improvements, and other changes to its products and services at any time and to discontinue any product or service without notice. Customers should obtain the latest relevant information before placing orders and should verify that such information is current and complete. All products are sold subject to TI's terms and conditions of sale supplied at the time of order acknowledgment.

TI warrants performance of its hardware products to the specifications applicable at the time of sale in accordance with TI's standard warranty. Testing and other quality control techniques are used to the extent TI deems necessary to support this warranty. Except where mandated by government requirements, testing of all parameters of each product is not necessarily performed.

TI assumes no liability for applications assistance or customer product design. Customers are responsible for their products and applications using TI components. To minimize the risks associated with customer products and applications, customers should provide adequate design and operating safeguards.

TI does not warrant or represent that any license, either express or implied, is granted under any TI patent right, copyright, mask work right, or other TI intellectual property right relating to any combination, machine, or process in which TI products or services are used. Information published by TI regarding third-party products or services does not constitute a license from TI to use such products or services or a warranty or endorsement thereof. Use of such information may require a license from a third party under the patents or other intellectual property of the third party, or a license from TI under the patents or other intellectual property of TI.

Reproduction of TI information in TI data books or data sheets is permissible only if reproduction is without alteration and is accompanied by all associated warranties, conditions, limitations, and notices. Reproduction of this information with alteration is an unfair and deceptive business practice. TI is not responsible or liable for such altered documentation. Information of third parties may be subject to additional restrictions.

Resale of TI products or services with statements different from or beyond the parameters stated by TI for that product or service voids all express and any implied warranties for the associated TI product or service and is an unfair and deceptive business practice. TI is not responsible or liable for any such statements.

TI products are not authorized for use in safety-critical applications (such as life support) where a failure of the TI product would reasonably be expected to cause severe personal injury or death, unless officers of the parties have executed an agreement specifically governing such use. Buyers represent that they have all necessary expertise in the safety and regulatory ramifications of their applications, and acknowledge and agree that they are solely responsible for all legal, regulatory and safety-related requirements concerning their products and any use of TI products in such safety-critical applications, notwithstanding any applications-related information or support that may be provided by TI. Further, Buyers must fully indemnify TI and its representatives against any damages arising out of the use of TI products in such safety-critical applications.

TI products are neither designed nor intended for use in military/aerospace applications or environments unless the TI products are specifically designated by TI as military-grade or "enhanced plastic." Only products designated by TI as military-grade meet military specifications. Buyers acknowledge and agree that any such use of TI products which TI has not designated as military-grade is solely at the Buyer's risk, and that they are solely responsible for compliance with all legal and regulatory requirements in connection with such use.

TI products are neither designed nor intended for use in automotive applications or environments unless the specific TI products are designated by TI as compliant with ISO/TS 16949 requirements. Buyers acknowledge and agree that, if they use any non-designated products in automotive applications, TI will not be responsible for any failure to meet such requirements.

Following are URLs where you can obtain information on other Texas Instruments products and application solutions:

Products		Applications	
Amplifiers	amplifier.ti.com	Audio	www.ti.com/audio
Data Converters	dataconverter.ti.com	Automotive	www.ti.com/automotive
DSP	dsp.ti.com	Broadband	www.ti.com/broadband
Interface	interface.ti.com	Digital Control	www.ti.com/digitalcontrol
Logic	logic.ti.com	Military	www.ti.com/military
Power Mgmt	power.ti.com	Optical Networking	www.ti.com/opticalnetwork
Microcontrollers	microcontroller.ti.com	Security	www.ti.com/security
RFID	www.ti-rfid.com	Telephony	www.ti.com/telephony
Low Power Wireless	www.ti.com/lpw	Video & Imaging	www.ti.com/video
		Wireless	www.ti.com/wireless

Mailing Address: Texas Instruments, Post Office Box 655303, Dallas, Texas 75265
Copyright © 2007, Texas Instruments Incorporated