

- 1) No carrier storage effect; superior frequency and switching characteristics
- 2) Rugged and no current concentration
- 3) Voltage-controlled device, hence low drive power
- 4) Easy parallel connection

■ **Toshiba MOSFETs have the following additional features:**

- | | |
|--|---|
| 1) Guaranteed avalanche capability..... | Allows an absorber circuit to be simplified |
| 2) Improved functioning of built-in diodes | Enhanced circuit design flexibility |
| 3) High ruggedness | Increased margin for circuit design |
| 4) High-speed switching | Higher speed in end-product's operation |
| 5) Low $R_{(DS)ON}$ | Reduced end-product's power consumption |
| 6) Smaller packages | Reduced end-product size |
| 7) Low drive loss | Reduced end product's power |

■ **Structures of Toshiba MOSFETs**

Double-Diffusion Structure

● **π -MOS**

Toshiba Power MOSFETs use a double-diffusion MOS (D-MOS) structure, which provides high withstand voltage, to form channels. This structure is especially well suited to high withstand voltage and high-current devices. A high level of integration yields a high-performance Power MOSFET with low on-resistance and low power loss.

Trench Structure

● **U-MOS**

Higher channel density is achieved by connecting channels vertically to form a U-groove at the gate region, a structure that yields a lower on-resistance than other MOSFET structures. The trench structure is primarily used for relatively low- V_{DS} MOSFETs.

Super-Junction Structure

● **DTMOS**

The super-junction structure, which has P-type pillar layers as shown at left, realizes high withstand voltage and on-resistance lower than the conventional theoretical limit of silicon.

2-1 MOSFET Product Lineup

SSM Series (V_{DSS} = 12 V to 60 V)

Very compact and thin, the SSM Series is suitable for use in various electronic devices. The SSM Series is available in a wide range of packages and features low voltage drive.

- Applications
- Cell phones
- Notebook PCs
- Portable electronic devices
- Small-signal switching

VS and PS Series (V_{DSS} = 12 V to 40 V)

Very compact and thin, the VS and PS Series are suitable for use in various electronic devices.

- Applications
- Cell phones
- Notebook PCs
- Portable electronic devices

Chip LGA Series (V_{DSS} = 20 V to 30 V)

The LGA Series is housed in an ultra-small and thin package and is suitable for use in lithium-ion secondary battery protection circuits in various portable electronic devices.

- Applications
- Lithium-ion secondary battery protection circuits

SOP and TSON Series (V_{DSS} = 20 V to 100 V)

The SOP and TSON Series are compact and thin, and require only a small mounting area. They are suitable for lithium-ion secondary battery protection circuits and notebook PCs.

- Applications
- Lithium-ion secondary battery protection circuits
- Notebook PCs
- Portable electronic devices
- DC-DC converters

DPAK+ Series (V_{DSS} = 40 to 100 V)

The DPAK+ Series, which uses Cu connectors, realizes high current-carrying capability and low on-resistance equivalent to the conventional D2PAK.

- Applications
- Automotive
- Motor drivers
- Switching power supplies

Low-V_{DSS}, High-Q_g U-MOS Series (V_{DSS} = 40 V to 100 V)

High integration is achieved using a trench technology. Low-voltage drive is possible due to ultra-low on-resistance.

- Applications
- Motor drivers
- Solenoids and lamp drivers

U-MOS Series for Synchronous Rectification (V_{DSS} = 60 V to 100 V)

Fabricated using a trench technology, the U-MOS Series is ideal for synchronous rectification on the secondary side of power supply circuits.

- Applications
- Switching power supplies
- AC adapters
- Motor drivers

New π -MOSVII Series (V_{DSS} = 200 V to 650 V)

The latest addition to the π -MOS portfolio, the π -MOSVII Series offers reduced capacitances due to optimized chip design and is available with a greatly wider range of electrical characteristics.

- Applications
- Switching power supplies
- AC adapters

Super-Junction DTMOS Series (V_{DSS} = 600, 650 V)

The super-junction DTMOS Series achieves low on-resistance and low gate charge (Q_g) due to the use of the latest super-junction structure.

- Applications
- Switching power supplies
- AC adapters
- Motor drivers

2-2 Part Numbering Schemes

Small-Signal MOSFET (SSM) Series

SSM 3 K 101 TU

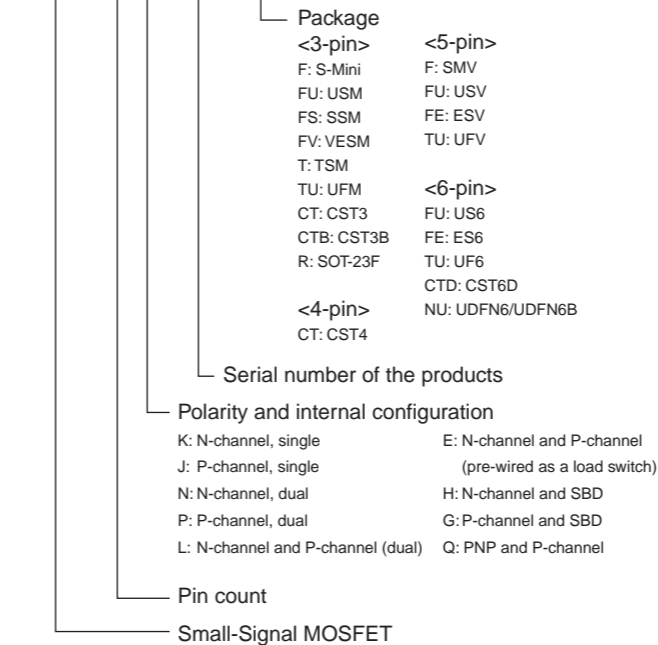

Conventional Multi-Pin Series

TPC8 0 01 -H

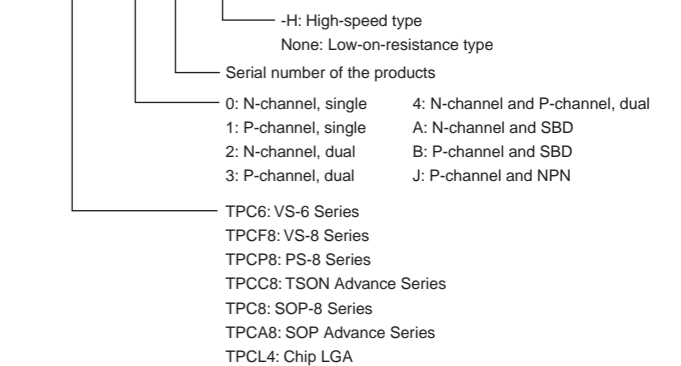

Conventional 3-Pin Series

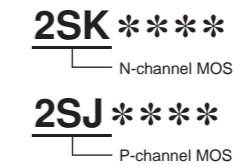

New Multi-Pin Series

TPH 4R6 0 6 N H

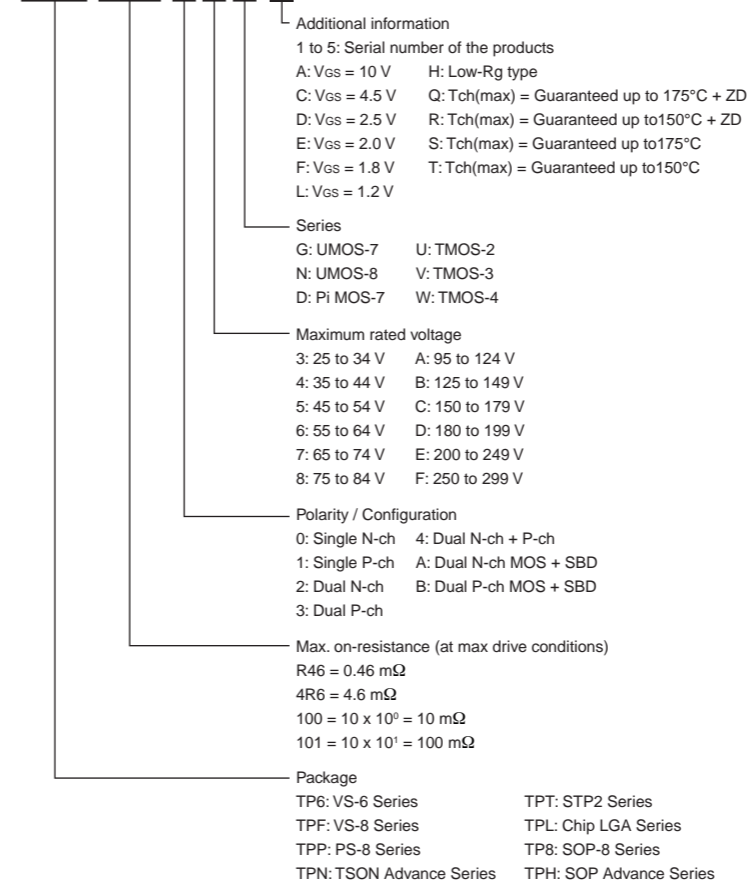

New 3-Pin Series

TK 55 A 10 J 1

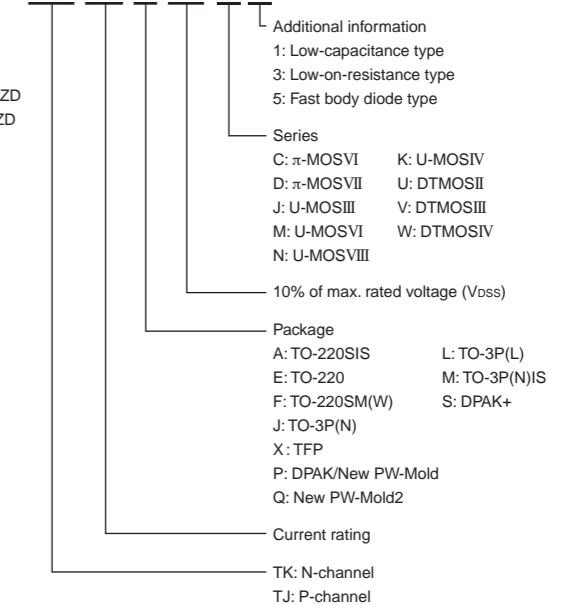

V _{DS} (V) I _D (A)	12	20	24	30	40	50	60	100	150	180	200	250	400	450	500	525	550	600	650	V _{DS} (V) I _D (A)		
0.1		☆ SSM3J35FS (44)Ⓞ + SSM3J35MFV (44)Ⓞ + SSM3J35CT (44)Ⓞ △ SSM6P35FU (44)Ⓞ + SSM6P35FE (45)Ⓞ ☆ SSM5N16FE (15)Ⓞ ☆ SSM5P16FE (45)Ⓞ		+ SSM3K15ACT (3.6)Ⓞ ☆ SSM3K15AFS (3.6)Ⓞ ☆ SSM3K15AFU (3.6)Ⓞ + SSM3K15AMFV (3.6)Ⓞ ☆ SSM3J15F (32)Ⓞ ☆ SSM3J15FU (32)Ⓞ ☆ SSM3J15FS (32)Ⓞ + SSM3J15CT (32)Ⓞ △ SSM6P15FU (32)Ⓞ △ SSM5P15FU (32)Ⓞ + SSM6P15FE (32)Ⓞ + SSM6N15AFE (3.6)Ⓞ △ SSM6N15AFU (3.6)Ⓞ ☆ SSM5N15FE (7)Ⓞ ☆ SSM5P15FE (32)Ⓞ ☆ SSM3K44FS (7)Ⓞ + SSM3K44MFV (7)Ⓞ △ SSM6N44FU (7)Ⓞ + SSM6N44FE (7)Ⓞ			☆ SSM3K17FU (40)Ⓞ △ SSM6N17FU (40)Ⓞ														0.1	
0.18		☆ SSM3K35FS (20)Ⓞ + SSM3K35MFV (20)Ⓞ + SSM3K35CT (20)Ⓞ △ SSM6N35FU (20)Ⓞ △ SSM6L35FU (20)Ⓞ + SSM6N35FE (20)Ⓞ + SSM6L35FE (20)Ⓞ																				0.18
0.2		△ SSM5P05FU (4)Ⓞ + SSM3K37CT (3.1)Ⓞ ☆ SSM3K37FS (3.1)Ⓞ		☆ SSM3J09FU (4.2)Ⓞ △ SSM6P09FU (4.2)Ⓞ			☆ SSM3K7002BF (3.3)Ⓞ △ SSM6N7002BFU (3.3)Ⓞ ☆ SSM3K7002BFS (3.3)Ⓞ ☆ 2SJ168 (2)Ⓞ + SSM6N7002BFE (3.3)Ⓞ															0.2
0.25		☆ SSM6N37CTD (3.1)Ⓞ + SSM6N37FE (3.1)Ⓞ △ SSM6N37FU (3.1)Ⓞ + SSM3K37MFV (3.1)Ⓞ																				0.25
0.33		△ SSM3J36TU (3.6)Ⓞ ☆ SSM3J36FS (3.6)Ⓞ + SSM3J36MFV (3.6)Ⓞ ☆ SSM6P36TU (3.6)Ⓞ + SSM6P36FE (3.6)Ⓞ																				0.33
0.4				☆ SSM3K09FU (1.2)Ⓞ																		0.4
0.5		☆ SSM4K27CT (0.205)Ⓞ ☆ SSM6L12TU (0.145)Ⓞ ☆ SSM6L36TU (1.52)Ⓞ + SSM3K36MFV (1.52)Ⓞ △ SSM3K36TU (1.52)Ⓞ + SSM6N36FE (1.52)Ⓞ + SSM6L36FE (1.52)Ⓞ △ SSM6N43FU (1.52)Ⓞ ☆ SSM3K43FS (1.52)Ⓞ		☆ SSM6N24TU (0.145)Ⓞ + SSM6K24FE (0.145)Ⓞ																		0.5
0.72		+ SSM6L14FE (0.3)Ⓞ + SSM6P41FE (0.3)Ⓞ																				0.72
0.8		+ SSM6N42FE (0.24)Ⓞ + SSM3J56MFV (0.39)Ⓞ ☆ SSM3K56FS (0.26)Ⓞ																				0.8

Legend **Product series** ①: π-MOSIII ②: π-MOSV ③: π-MOSVI ④: L²-π-MOSV ⑤: L²-π-MOSVI ⑥: U-MOS ⑦: π-MOSVII ⑧: π-MOSIV ⑩: DTMOSII

Package ◊ PW-Mini ↗ VS-8 ♥ VS-6 ♣ PS-8 ▲ TO-92MOD ↘ New PW-Mold ○ TSON Advance ↖ New PW-Mold2 ☆ TO-220SM(W) □ TO-3P(N) ○ TO-3P(N)IS ● TO-3P(L) ▣ Chip LGA * S-Mini + TSM ☆ USM △ UFM ☆ SSM △ USV ☆ UFV ☆ ESV ▷ DPAK ■ SOT-23F □ UDFN6 ☆ DPAK+ ☒ TO-220SM

★ SOP-8 ▶ SOP Advance ◆ TO-220NIS ⊗ TO-220SIS □ TO-220 ♣ TFP
 +VESM +CST3 ◊ CST3B ⊕ CST4 +SMV △ US6 ● UF6 +ES6 *CST6D

Notes:
 () = R_{DS(on)} max * = 1.8-V drive P = P-ch NS = N-ch + SBD PD = P-ch + Driver
 S = 10-V drive V = High-speed diode CN = Complementary N-ch PS = P-ch + SBD (load switch)
 # = 2.5-V drive N = N-ch CP = Complementary P-ch [] = Under development

V _{oss} (V)	12	20	24	30	40	60	100	150	180	200	250	400	450	500	525	550	600	650	800	900	1000	V _{oss} (V)		
I _b (A)																						I _b (A)		
1	PS + SSM5G02TU (0.16)Ⓢ PD + SSM6E01TU (0.16)Ⓢ					◇ 2SJ360 (0.73)Ⓢ ◇ 2SK2963 (0.7)Ⓢ				◇ 2SK2992 (3.5)Ⓢ	CP + TPC8404(2.55)Ⓢ CN + TPC8404(1.7)Ⓢ										TK1Q90A (9)Ⓢ TK1P90A (9)Ⓢ	1		
1.1				△ SSM3J112TU (0.79)Ⓢ																		1.1		
1.2		△ SSM3K106TU (0.53)Ⓢ ● SSM6P54TU (0.228)Ⓢ NS + SSM5H07TU (0.54)Ⓢ + SSM6K30FE (0.42)Ⓢ																					1.2	
1.3		PS + TPCP8BA1 (0.18)Ⓢ		+ SSM6J207FE (0.491)Ⓢ																		1.3		
1.4				△ SSM3J118TU (0.48)Ⓢ ● SSM6P40TU (0.403)Ⓢ PS + SSM5G11TU (0.403)Ⓢ NS + SSM5H01TU (0.45)Ⓢ + SSM6K210FE (0.371)Ⓢ																			1.4	
1.5	PS + SSM5G09TU (0.13)Ⓢ	● SSM6P39TU (0.213)Ⓢ NS + SSM5H08TU (0.16)Ⓢ		PS + SSM5G10TU (0.213)Ⓢ																		1.5		
1.6		NS + SSM5H10TU (0.119)Ⓢ NS + TPCP8AA1 (0.105)Ⓢ ● SSM6L39TU (0.119)Ⓢ ● SSM6N39TU (0.119)Ⓢ		NS + SSM5H11TU (0.182)Ⓢ ● SSM6L40TU (0.182)Ⓢ ● SSM6N40TU (0.182)Ⓢ																			1.6	
1.7				+ SSM3J305T (0.477)Ⓢ																		1.7		
1.8	PD + SSM6E03TU (0.144)Ⓢ																					1.8		
1.9				NS + SSM5H16TU (0.133)Ⓢ + SSM6K208FE (0.133)Ⓢ																		1.9		
2		△ SSM3K122TU (0.123)Ⓢ ● SSM6K405TU (0.126)Ⓢ + SSM6K204FE (0.126)Ⓢ PS □ SSM6G18NU (0.112)Ⓢ ◇ SSM3J46CTB (0.103)Ⓢ * SSM3J325F (0.15)Ⓢ		△ SSM3J117TU (0.225)Ⓢ △ SSM3K127TU (0.123)Ⓢ ● SSM6J402TU (0.225)Ⓢ ■ SSM3K336R (0.11)Ⓢ ◇ 2SJ511 (0.45)Ⓢ ◇ 2SK2964 (0.18)Ⓢ			◇ 2SK2615 (0.3)Ⓢ ◇ 2SK3658 (0.3)Ⓢ ● SSM6K407TU (0.44)Ⓢ				J 2SJ610 (2.55)Ⓢ											J 2SK2865 (5.0)Ⓢ ◇ 2SK3767 (4.5)Ⓢ □ 2SK4002 (5)Ⓢ □ TK2Q60D (4.3)Ⓢ J TK2P60D (4.3)Ⓢ	TK2A65D (3.26)Ⓢ	2
2.2				△ SSM3K116TU (0.1)Ⓢ																		2.2		
2.3				+ SSM6K202FE (0.085)Ⓢ																		2.3		
2.4				+ SSM3J306T (0.225)Ⓢ △ SSM3K124TU (0.12)Ⓢ																		2.4		
2.5				△ SSM3K119TU (0.074)Ⓢ ● SSM6J401TU (0.145)Ⓢ			+ SSM3K316T (0.145)Ⓢ			J 2SJ567 (2.0)Ⓢ □ 2SJ680 (2.0)Ⓢ											TK3A60DA (2.8)Ⓢ TK3A65DA (2.51)Ⓢ 2SK3566 (6.4)Ⓢ	2.5		
2.6		+ SSM6J213FE (0.097)Ⓢ																				2.6		
2.7		PS + TPCF8B01 (0.11)Ⓢ																				2.7		
2.8		P + TPC6130 (0.106)Ⓢ																				2.8		
3		● SSM6K404TU (0.055)Ⓢ △ SSM3J135TU (0.103)Ⓢ		● SSM6K34TU (0.077)Ⓢ NS + SSM5H14F (0.078)Ⓢ										◆ 2SK2862 (3.2)Ⓢ ▷ TK3P50D (3.0)Ⓢ							TK3A65D (2.25)Ⓢ	□ 2SK2719 (4.3)Ⓢ ◇ 2SK3564 (4.3)Ⓢ	3	
3.2		△ SSM3K121TU (0.048)Ⓢ + SSM6K211FE (0.047)Ⓢ △ SSM3J134TU (0.093)Ⓢ		CP + TPCF8402 (0.077)Ⓢ P + TPCF8304 (0.072)Ⓢ P + TPCF8306 (0.072)Ⓢ																		3.2		
3.4		+ SSM6J215FE (0.059)Ⓢ																				3.4		
3.5		+ SSM3K301T (0.056)Ⓢ		■ SSM3K329R (0.126)Ⓢ																		TK4A55DA (2.45)Ⓢ ▷ TK4P55DA (2.45)Ⓢ TK4A60DA (2.2)Ⓢ ▷ TK4P60DA (2.2)Ⓢ TK4Q60DA (2.2)Ⓢ	3.5	
3.6				+ SSM6J214FE (0.057)Ⓢ																		TK4A60DB (2.0)Ⓢ ▷ TK4P60DB (2.0)Ⓢ	3.6	
3.7																						3.7		
3.8		P + TPCP8303 (0.046)Ⓢ																				3.8		
3.9		■ SSM3J327R (0.093)Ⓢ																				3.9		
4		□ SSM6P47NU (0.095)Ⓢ + SSM6J212FE (0.0407)Ⓢ ● SSM6J412TU (0.0427)Ⓢ □ SSM6P49NU (0.056)Ⓢ P + TPCF8305 (0.058)Ⓢ P + TPCP8306 (0.058)Ⓢ ■ SSM3J331R (0.055)Ⓢ □ SSM6Q01NU (0.059)Ⓢ		■ SSM3J334R (0.071)Ⓢ □ SSM6N55NU (0.043)Ⓢ CN + TPCF8402 (0.05)Ⓢ CN + TPCP8404 (0.05)Ⓢ CP + TPCP8404 (0.05)Ⓢ											TK4A50D (2.0)Ⓢ ▷ TK4P50D (2.0)Ⓢ	TK4A53D (1.7)Ⓢ	TK4A55D (1.88)Ⓢ ▷ TK4P55D (1.88)Ⓢ	TK4A60D (1.7)Ⓢ ▷ TK4P60D (1.7)Ⓢ						4

Legend Product series ①: π-MOSIII ②: π-MOSV ③: π-MOSVI ④: L²-π-MOSV ⑤: L²-π-MOSVI ⑥: U-MOS ⑦: π-MOSVII ⑧: π-MOSIV ⑩: DTMOSII

Package ◇ PW-Mini ↗ VS-8 ♥ VS-6 ♣ PS-8 ▲ TO-92MOD ↘ New PW-Mold ○ TSON Advance □ New PW-Mold2
 ◆ TO-220SM(W) □ TO-3P(N) ○ TO-3P(N)IS ● TO-3P(L) □ Chip LGA * S-Mini + TSM + USM △ UFM ☆ SSM
 △ USV * UFV ☆ ESV ▷ DPAK ■ SOT-23F □ UDFN6 ☆ DPAK+ □ TO-220SM

★ SOP-8 ▶ SOP Advance ◆ TO-220NIS ○ TO-220SIS □ TO-220 ♣ TFP
 +VESM +CST3 ◇ CST3B □ CST4 +SMV / US6 ● UF6 +ES6 *CST6D

Notes:
 () = Reason max * = 1.8-V drive P = P-ch NS = N-ch + SBD PD = P-ch + Driver
 \$ = 10-V drive ♣ = High-speed diode CN = Complementary N-ch PS = P-ch + SBD (load switch)
 # = 2.5-V drive N = N-ch CP = Complementary P-ch [] = Under development

V _{oss} (V) I _b (A)	12	20	24	30	40	50	60	100	150	180	200	250	400	450	500	525	550	600	650	700	800	900	1000	V _{oss} (V) I _b (A)		
4.2		△SSM3K123TU (0.028)Ⓢ ●SSM6K403TU (0.028)Ⓢ		N▲TPCP8204 (0.05)Ⓢ -:SSM3K320T (0.077)Ⓢ																					4.2	
4.4		△SSM3J130TU (0.0258)Ⓢ		●SSM6K406TU (0.0385)Ⓢ																					4.4	
4.5				P♥TPC6110 (0.056)Ⓢ										⊗TK5A45DA (1.75)Ⓢ					⊗TK5A65DA (1.67)Ⓢ						4.5	
4.7		-:SSM3K309T (0.031)Ⓢ																							4.7	
5		-:SSM3K310T (0.028)Ⓢ P♥TPC6113 (0.055)Ⓢ		P★TPC8104-H (0.065)Ⓢ P♥TPC6109-H (0.059)Ⓢ	CP▲TPCP8406 (0.041)Ⓢ P★TPC8134 (0.066)Ⓢ		N▲TPCP8007-H (0.057)Ⓢ								◆2SK3466 (1.5)Ⓢ ⊗TK5A50D (1.5)Ⓢ ▷TK5P50D (1.5)Ⓢ	⊗TK5A53D (1.5)Ⓢ ▷TK5P53D (1.5)Ⓢ	⊗TK5A55D (1.7)Ⓢ	⊗TK5A60D (1.43)Ⓢ	⊗TK5A65D (1.43)Ⓢ	◆2SK2274 (1.7)			⊗2SK3565 (2.5)Ⓢ ⊗2SK3742 (2.5)Ⓢ		5	
5.2		P▲TPC8105 (0.017)Ⓢ																							5.2	
5.3					N♥TPC8009-H (0.081)Ⓢ CP★TPC8408 (0.043)Ⓢ																				5.3	
5.4		△SSM3J132TU (0.017)Ⓢ																							5.4	
5.5	PD▲TPC8401 (0.038)Ⓢ P♥TPC6103 (0.035)Ⓢ	P★TPC6111 (0.04)Ⓢ △SSM3J133TU (0.0298)Ⓢ												⊗TK6A45DA (1.35)Ⓢ				⊗TK6A55DA (1.48)Ⓢ							5.5	
5.6		P#▲TPCP8101 (0.030)Ⓢ		-:SSM3J326T (0.0457)Ⓢ																					5.6	
5.9				N♥TPC8008-H (0.060)Ⓢ																					5.9	
6		■SSM3J326R (0.0298)Ⓢ □SSM6J502NU (0.0231)Ⓢ □SSM6J503NU (0.0324)Ⓢ N#TPCL4201 (0.031)Ⓢ N♥TPC6012 (0.02)Ⓢ P▷TPCF8105 (0.03)Ⓢ P▲TPCP8305 (0.03)Ⓢ ●SSM6J414TU (0.0221)Ⓢ N▲TPCP8206 (0.026)Ⓢ	N#TPCL4203 (0.036)Ⓢ	N♥TPC6011 (0.020)Ⓢ ■SSM3J332R (0.042)Ⓢ ■SSM3K333R (0.028)Ⓢ N#TPCL4202 (0.04)Ⓢ △SSM3K131TU (0.0415)Ⓢ CP▲TPCP8405 (0.031)Ⓢ P▷TPCF8107 (0.028)Ⓢ ■SSM3K335R (0.038)Ⓢ	CN▲TPCP8406 (0.032)Ⓢ											⊗TK6A50D (1.4)Ⓢ	⊗TK6A53D (1.3)Ⓢ ▽TK6P53D (1.3)Ⓢ		⊗TK6A60D (1.25)Ⓢ	⊗TK6A65D (1.11)Ⓢ			⊗2SK4013 (1.7)Ⓢ	⊗2SK4014 (2.0)Ⓢ		6
6.1					CN★TPC8408 (0.032)Ⓢ		N♥TPC8010-H (0.059)Ⓢ																		6.1	
6.5					CN▲TPCP8405 (0.026)Ⓢ N▲TPCP8205-H (0.026)Ⓢ									⊗TK7A50DA (1.22)Ⓢ									⊗2SK3880 (1.7)Ⓢ		6.5	
7		N▷TPCF8003 (0.018)Ⓢ P▷TPCF8108 (0.026)Ⓢ		N▷TPCF8004 (0.03)Ⓢ	P★TPC8132 (0.033)Ⓢ									⊗TK7A50DA (1.22)Ⓢ	⊗TK7A50D (1.22)Ⓢ ▷TK7P50D (1.22)Ⓢ		⊗TK7A55D (1.25)Ⓢ		⊗TK7A65D (0.98)Ⓢ			□2SK3633 (1.7)Ⓢ	□2SK4115 (2.0)Ⓢ		7	
7.2				P▲TPCP8106 (0.033)Ⓢ																					7.2	
7.4				CP★TPC8407 (0.023)Ⓢ																					7.4	
7.5					P▷TPCA8107-H (0.03)Ⓢ									⊗TK8A25DA (0.5)Ⓢ ▷TK8P25DA (0.5)Ⓢ	⊗TK8A45DA (1.1)Ⓢ	⊗TK8A50DA (1.04)Ⓢ		⊗TK8A55DA (1.07)Ⓢ	⊗TK8A60DA (1.0)Ⓢ						7.5	
8				N★TPC8224-H (0.026)Ⓢ			☆TK8S06K3L (0.054)Ⓢ ☆TJ8S06M3L (0.104)Ⓢ	⊗TK8A10K3 (0.12)Ⓢ							⊗TK8A45D (0.9)Ⓢ	⊗TK8A50D (0.85)Ⓢ				⊗TK8A65D (0.84)Ⓢ			⊗2SK2847 (1.4)Ⓢ ⊗2SK3799 (1.3)Ⓢ		8	
8.3					N▲TPCP8004 (0.009)Ⓢ																				8.3	
8.5																			⊗TK9A55DA (0.86)Ⓢ				⊗2SK3017 (1.25)Ⓢ		8.5	
9		N▲TPCP8006 (0.01)Ⓢ P▷TPC8129 (0.0224)Ⓢ		N▷TPC8067-H (0.025)Ⓢ N★TPC8067-H (0.025)Ⓢ N★TPC8223-H (0.017)Ⓢ CN★TPC8407 (0.017)Ⓢ	P★TPC8133 (0.015)Ⓢ		N★TPC8053-H (0.0225)Ⓢ ☆TJ9A10M3 (0.16)Ⓢ								⊗TK9A45D (0.77)Ⓢ				⊗TK9A60D (0.83)Ⓢ				□2SK3878 (1.3)Ⓢ		9	
9.4		P▷TPC8136 (0.016)Ⓢ																							9.4	
9.5		●SSM6J409TU (0.0221)Ⓢ																							9.5	
10	□SSM6J505NU (0.01)Ⓢ	□SSM6J501NU (0.0153)Ⓢ ●SSM6K411TU (0.012)Ⓢ		P★TPC8125 (0.013)Ⓢ N▷TPC8131 (0.0176)Ⓢ	☆TK10S04K3L (0.028)Ⓢ ☆TJ10S04M3L (0.044)Ⓢ									◆TK10X40D (0.55)Ⓢ	⊗TK10A50D (0.72)Ⓢ		⊗TK10A55D (0.72)Ⓢ	⊗TK10A60D (0.75)Ⓢ					□2SK2968 (1.25)Ⓢ		10	

Legend Product series ①: π-MOSIII ②: π-MOSV ③: π-MOSVI ④: L²-π-MOSV ⑤: L²-π-MOSVI ⑥: U-MOS ⑦: π-MOSVII ⑧: π-MOSIV ⑩: DTMOSII

Package ◊PW-Mini ↗VS-8 ♥VS-6 ♣PS-8 ▲TO-92MOD ↓New PW-Mold ○TSON Advance ♪New PW-Mold2

◆TO-220SM(W) □TO-3P(N) ○TO-3P(N)IS ●TO-3P(L) ■Chip LGA *S-Mini +TSM *USM △UFM ☆SSM

△USV *UFV ♣ESV ▷DPAK ■SOT-23F □UDFN6 ☆DPAK+ ☒TO-220SM

★SOP-8 ▶SOP Advance ◆TO-220NIS ⊗TO-220SIS □TO-220 ♣TFP

+VESM +CST3 ◊CST3B ⊗CST4 +SMV /US6 ●UF6 +ES6 *CST6D

Notes:
 () = R_{oss(on)} max
 \$ = 10-V drive
 # = 2.5-V drive
 * = 1.8-V drive
 ♪ = High-speed diode
 N = N-ch
 P = P-ch
 CN = Complementary N-ch
 CP = Complementary P-ch
 NS = N-ch + SBD
 PS = P-ch + SBD
 [] = Under development
 PD = P-ch + Driver (load switch)

V _{DS} (V) I _D (A)	20	30	40	50	60	75	80	100	200	250	300	450	500	525	550	600	650	900/1000	V _{DS} (V) I _D (A)		
11		P ★ TPC8126 (0.010)Ⓢ N ★ TPC8005-H (0.0129)Ⓢ P ★ TPC8123 (0.0090)Ⓢ N ★ TPC8066-H (0.015)Ⓢ N ★ TPC8066-H (0.016)Ⓢ			N ★ TPC8050-H (0.0145)Ⓢ			TJ11A10M3 (0.1)Ⓢ				Ⓢ TK11A45D (0.62)Ⓢ Ⓢ TK11A50D (0.6)Ⓢ		Ⓢ TK11A55D (0.63)Ⓢ Ⓢ TK11A60D (0.65)Ⓢ Ⓢ TK11A65D (0.7)Ⓢ						11	
12		NS ★ TPC8006-H (0.0101)Ⓢ P ★ TPC8124 (0.008)Ⓢ	N ★ TPC8052-H (0.0115)Ⓢ P ★ TPC8124 (0.008)Ⓢ					Ⓢ TK12A10K3 (0.08)Ⓢ				Ⓢ TK12A45D (0.52)Ⓢ Ⓢ TK12A50D (0.52)Ⓢ	Ⓢ TK12A53D (0.58)Ⓢ Ⓢ TK12X53D (0.58)Ⓢ	Ⓢ TK12J55D (0.57)Ⓢ Ⓢ TK12A55D (0.57)Ⓢ	Ⓢ TK12A60U (0.4)Ⓢ Ⓢ TK12E60U (0.4)Ⓢ Ⓢ TK12J60U (0.4)Ⓢ Ⓢ TK12A60D (0.55)Ⓢ Ⓢ TK12X60U (0.42)Ⓢ	Ⓢ TK12A65D (0.54)Ⓢ				12	
12.5												Ⓢ TK13A50DA (0.47)Ⓢ	Ⓢ TK13A55DA (0.48)Ⓢ							12.5	
13	P ★ TPCC8137 (0.010)Ⓢ	P ★ TPC8131 (0.017)Ⓢ P ★ TPC8127 (0.065)Ⓢ N ★ TPC8065-H (0.0114)Ⓢ N ★ TPC8065-H (0.0118)Ⓢ N ★ TPC8068-H (0.0116)Ⓢ			N ★ TPC8049-H (0.0107)Ⓢ		N ★ TPC8051-H (0.0097)Ⓢ			Ⓢ TK13A25D (0.25)Ⓢ Ⓢ TK13P25D (0.25)Ⓢ Ⓢ TK13E25D (0.25)Ⓢ		Ⓢ 2SK3544 (0.4)Ⓢ Ⓢ TK13A45D (0.46)Ⓢ	Ⓢ TK13A50D (0.4)Ⓢ			Ⓢ TK13A60D (0.43)Ⓢ Ⓢ TK13A65U (0.38)Ⓢ Ⓢ TK13A65D (0.47)Ⓢ Ⓢ TK13J65U (0.38)Ⓢ		900V: Ⓢ 2SK4207 (0.95)		13	
13.5												Ⓢ TK14A45DA (0.41)Ⓢ								13.5	
14												Ⓢ TK14A45D (0.34)Ⓢ			Ⓢ TK14A55D (0.37)Ⓢ					14	
15		N ★ TPC8092 (0.009)Ⓢ N ★ TPC8068-H (0.0116)Ⓢ	P ★ TJ15P04M3 (0.036)Ⓢ N ★ TPCC8011-H (0.012)Ⓢ			P ★ TPC8053-H (0.0223)Ⓢ ☆ TJ15S06M3L (0.05)Ⓢ			Ⓢ TK15A20D (0.18)Ⓢ				Ⓢ TK15A50D (0.3)Ⓢ Ⓢ TK15J50D (0.4)Ⓢ			Ⓢ TK15A60U (0.3)Ⓢ Ⓢ TK15E60U (0.3)Ⓢ Ⓢ TK15J60U (0.3)Ⓢ Ⓢ TK15A60D (0.37)Ⓢ Ⓢ TK15X60U (0.31)Ⓢ				15	
16		P ★ TPC8128 (0.005)Ⓢ N ★ TPC8064-H (0.0084)Ⓢ N ★ TPC8065-H (0.0114)Ⓢ	N ★ TPC8047-H (0.0076)Ⓢ			N ★ TPC8048-H (0.0069)Ⓢ						Ⓢ TK16A45D (0.27)Ⓢ			Ⓢ TK16J55D (0.37)Ⓢ Ⓢ TK16A55D (0.33)Ⓢ					16	
17		N ★ TPC8063-H (0.007)Ⓢ N ★ TPC8074 (0.0065)Ⓢ N ★ TPC8086 (0.0064)Ⓢ 33V N ★ TPC8084 (0.0068)Ⓢ																Ⓢ TK17A65U (0.26)Ⓢ Ⓢ TK17J65U (0.26)Ⓢ		17	
18	P ★ TPCC8138 (0.0075)Ⓢ	N ★ TPC8062-H (0.0058)Ⓢ N ★ TPC8059-H (0.004)Ⓢ N ★ TPC8058-H (0.0032)Ⓢ N ★ TPC8057-H (0.0028)Ⓢ N ★ TPC8056-H (0.0024)Ⓢ N ★ TPC8082 (0.0041)Ⓢ N ★ TPC8081 (0.0033)Ⓢ N ★ TPC8080 (0.0028)Ⓢ P ★ TPC8120 (0.0032)Ⓢ P ★ TPCC8103 (0.012)Ⓢ N ★ TPC8055-H (0.0021)Ⓢ N ★ TPC8073 (0.0047)Ⓢ N ★ TPC8085 (0.0047)Ⓢ N ★ TPC8088 (0.0024)Ⓢ N ★ TPC8087 (0.0021)Ⓢ N ★ TPC8076 (0.0049)Ⓢ 33V N ★ TPC8075 (0.0026)Ⓢ 33V N ★ TPC8078 (0.0022)Ⓢ	N ★ TPC8045-H (0.0039)Ⓢ N ★ TPC8046-H (0.0057)Ⓢ					Ⓢ TK18E10K3 (0.042)Ⓢ			Ⓢ TK18A30D (0.139)Ⓢ		Ⓢ 2SK2917 (0.27)Ⓢ Ⓢ TK18A50D (0.27)Ⓢ								18
19		N ★ TPCC8064-H (0.0082)Ⓢ										Ⓢ TK19A45D (0.25)Ⓢ			Ⓢ TK19J55D (0.33)Ⓢ					19	
20	N ★ TPCC8093 (0.0058)Ⓢ	P ★ TPCC8104 (0.0088)Ⓢ N ★ TPCC8074 (0.0063)Ⓢ N ★ TPC8064-H (0.0082)Ⓢ	N ★ TPC8052-H (0.0115)Ⓢ N ★ TK20P04M1 (0.029)Ⓢ ☆ TK20S04K3L (0.014)Ⓢ ☆ TJ20S04M3L (0.0222)Ⓢ		☆ TK20S06K3L (0.029)Ⓢ			Ⓢ TJ20A10M3 (0.090)Ⓢ		Ⓢ TK20A25D (0.1)Ⓢ			Ⓢ TK20J50D (0.27)Ⓢ			Ⓢ TK20A60U (0.19)Ⓢ Ⓢ TK20E60U (0.19)Ⓢ Ⓢ TK20J60U (0.19)Ⓢ Ⓢ TK20X60U (0.20)Ⓢ				20	
21		33V N ★ TPCC8084 (0.0064)Ⓢ																		21	
22		N ★ TPC8063-H (0.0068)Ⓢ										Ⓢ TK22A10N1 (0.0138)Ⓢ Ⓢ TK22E10N1 (0.0138)Ⓢ								22	
23		P ★ TPCC8105 (0.0078)Ⓢ																		23	

Legend Product series ①: π-MOSIII ②: π-MOSV ③: π-MOSVI ④: L²-π-MOSV ⑤: L²-π-MOSVI ⑥: U-MOS ⑦: π-MOSVII ⑧: π-MOSIV ⑩: DTMOSII

Package ◊ PW-Mini ↗ VS-8 ♥ VS-6 ♣ PS-8 ▲ TO-92MOD ↘ New PW-Mold ◊ TSON Advance ↗ New PW-Mold2

✦ TO-220SM(W) ◻ TO-3P(N) ○ TO-3P(N)IS ● TO-3P(L) Ⓢ Chip LGA * S-Mini + TSM + USM △ UFM ☆ SSM

△ USV * UFV ☆ ESV ▷ DPAK ■ SOT-23F ◻ UDFN6 ☆ DPAK+ ☒ TO-220SM

★ SOP-8 ▶ SOP Advance ◆ TO-220NIS ⊗ TO-220SIS ◻ TO-220 ♣ TFP

+VESM +CST3 ◊ CST3B ◊ CST4 +SMV /US6 *UF6 +ES6 *CST6D

Notes:
 () = R_{DS(on)} max * = 1.8-V drive P = P-ch NS = N-ch + SBD PD = P-ch + Driver
 \$ = 10-V drive † = High-speed diode CN = Complementary N-ch PS = P-ch + SBD
 # = 2.5-V drive N = N-ch CP = Complementary P-ch [] = Under development (load switch)

V _{DS} (V) I _D (A)	20	30	40	50	60	75	80	100	120	200	250	300	450	500	525	550	600	900/1000	V _{DS} (V) I _D (A)	
24		P ▶ TPCA8109 (0.009)Ⓢ																	24	
25										⊗ TK25A10K3 (0.040)Ⓢ									25	
27		N ◊ TPCC8073 (0.0045) 33V N ◊ TPCC8076 (0.0047)Ⓢ N ◊ TPCC8062-H (0.0056)Ⓢ																		27
28		N ▶ TPCA8062-H (0.0056)Ⓢ																	28	
30																			30	
32		N ▶ TPCA8059-H (0.0038)Ⓢ N ▶ TPCA8082 (0.0039)Ⓢ	N ▶ TPCA8047-H (0.0073)Ⓢ																32	
34		P ▶ TPCA8128 (0.0048)Ⓢ																	34	
35		NS ▶ TPCA8A11-H (0.0036)Ⓢ	☆ TK35S04K3L (0.0103)Ⓢ																35	
38		N ▶ TPCA8058-H (0.0033)Ⓢ N ▶ TPCA8081 (0.0033)Ⓢ	N ▶ TPCA8046-H (0.0054)Ⓢ																38	
40	N ▶ TPCA8011-H (0.0035)Ⓢ	N ▷ TK40P03M1 (0.0108)Ⓢ P ▶ TPCA8128 (0.0048)Ⓢ NS ▶ TPCA8A10-H (0.0033)Ⓢ	N ▷ TK40P04M1 (0.0111)Ⓢ ☆ TJ40S04M3L (0.0091)Ⓢ				⊗ TK40A08K3 (0.009)Ⓢ												40	
42		N ▶ TPCA8057-H (0.0026)Ⓢ N ▶ TPCA8080 (0.0026)Ⓢ																		42
45		P ▶ TPCA8120 (0.0033)Ⓢ N ▷ TK45P03M1 (0.0097)Ⓢ																		45
46			N ▶ TPCA8045-H (0.0036)Ⓢ																	46
48		N ▶ TPCA8056-H (0.0022)Ⓢ N ▶ TPCA8088 (0.0022)Ⓢ 33V N ▶ TPCA8075 (0.0024)Ⓢ																		48
50		N ▷ TK50P03M1 (0.0075)Ⓢ	N ▷ TK50P04M1 (0.0087)Ⓢ ⊗ TK50A04K3 (0.0035)Ⓢ ☆ TK50S04K3L (0.0054)Ⓢ																	50
51		NS ▶ TPCA8A09-H (0.0023)Ⓢ																		51
54		33V N ▶ TPCA8078 (0.0021)Ⓢ																		54
55																				55
56		N ▶ TPCA8055-H (0.0019)Ⓢ N ▶ TPCA8087 (0.0019)Ⓢ																		56
60		N ▷ TK60P03M1 (0.0064)Ⓢ	☆ TJ60S04M3L (0.0063)Ⓢ																	60
65			☆ TK65S04K3L (0.0045)Ⓢ																	65
70																				70
72																				72
75																				75
80			☆ TK80S04K3L (0.0031)Ⓢ ☆ TJ80S04M3L (0.0052)Ⓢ ☆ TK80F04K3L (0.0045)Ⓢ																	80
100			☆ TK100F04K3 (0.0033)Ⓢ ☆ TK100F04K3L (0.0033)Ⓢ ☆ TJ100F04M3L (0.0036)Ⓢ																	100
130																				130
150			☆ TK150F04K3 (0.0021)Ⓢ ☆ TK150F04K3L (0.0021)Ⓢ ☆ TJ150F04M3L (0.0028)Ⓢ																	150

Legend Product series ① : π-MOSIII ② : π-MOSV ③ : π-MOSVI ④ : L²-π-MOSV ⑤ : L²-π-MOSVI ⑥ : U-MOS ⑦ : π-MOSVII ⑧ : π-MOSIV ⑩ : DTMOSII

Package ◊ PW-Mini ↗ VS-8 ♥ VS-6 ♣ PS-8 ▲ TO-92MOD ↓ New PW-Mold ○ TSON Advance ♪ New PW-Mold2

⊕ TO-220SM(W) □ TO-3P(N) ○ TO-3P(N)IS ● TO-3P(L) ▣ Chip LGA * S-Mini † TSM * USM △ UFM ☆ SSM

★ SOP-8 ▶ SOP Advance ◆ TO-220NIS ⊗ TO-220SIS ◼ TO-220 ⬤ TFP

⊕ VESM † CST3 † CST3B † CST4 † SMV / US6 ● UF6 † ES6 * CST6D

△ USV * UFV ☆ ESV ▷ DPAK ▣ SOT-23F □ UDFN6 ☆ DPAK+ ◻ TO-220SM

Notes:
 () = R_{DS(on)} max * = 1.8-V drive P = P-ch NS = N-ch + SBD PD = P-ch + Driver
 \$ = 10-V drive Y = High-speed diode CN = Complementary N-ch PS = P-ch + SBD (load switch)
 # = 2.5-V drive N = N-ch CP = Complementary P-ch [] = Under development

4-1 Packaging Options

SSM Series

The SSM Series comes in small, thin packages suitable for portable devices. Chip-scale packages (1006 size) help reduce system size.

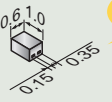
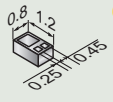
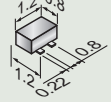
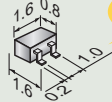
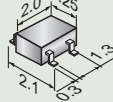
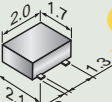
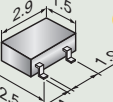
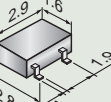
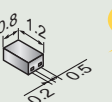
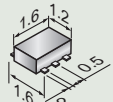
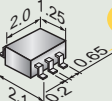
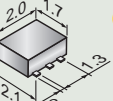
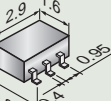
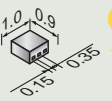
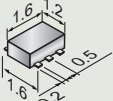
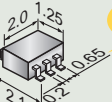
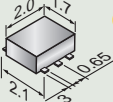
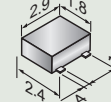
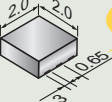
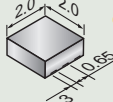
CST3 Chip-Scale Package, Transfer Molded, 3-Pin Typical product: SSM3K35CT  Thickness: 0.38 typ. Unit: mm	CST3B Chip-Scale Package, Transfer Molded, 3-Pin, B-Type Typical product: SSM3J46CTB  Thickness: 0.48 typ. Unit: mm	VESM (SOT-723) Very Extreme Super-Mini Typical product: SSM3K35MFV  Thickness: 0.5 typ. Unit: mm	SSM (SOT-416)(SC-75) Small Super-Mini Typical product: SSM3K35FS  Thickness: 0.7 typ. Unit: mm	USM (SOT-323)(SC-70) Ultra-Super-Mini Typical product: SSM3K15AFU  Thickness: 0.9 typ. Unit: mm
UFM Ultra-super-Mini Flat lead Typical product: SSM3J130TU  Thickness: 0.7 typ. Unit: mm	S-Mini (SOT-346)(SC-59) Super-Mini Typical product: SSM3K15F  Thickness: 1.1 typ. Unit: mm	TSM Thin Super-Mini Typical product: SSM3J326T  Thickness: 0.7 typ. Unit: mm	CST4 Chip-Scale Package, Transfer Molded, 4-Pin Typical product: SSM4K27CT  Thickness: 0.38 typ. Unit: mm	ESV (SOT-553) Extreme Super-mini, 5-pin Typical product: SSM5N15FE  Thickness: 0.55 typ. Unit: mm
USV (SOT-353)(SC-88A) Ultra-Super-mini, 5-pin Typical product: SSM5N15FU  Thickness: 0.9 typ. Unit: mm	UFV Ultra-super-mini, Flat lead, 5-pin Typical product: SSM5H12TU  Thickness: 0.7 typ. Unit: mm	SMV (SOT-25)(SC-74A) Super-Mini, 5-pin Typical product: SSM5H14F  Thickness: 1.1 typ. Unit: mm	CST6D Chip-Scale Package, Transfer Molded, 6-Pin, D-Type Typical product: SSM6N37CTD  Thickness: 0.38 typ. Unit: mm	ES6 (SOT-563) Extreme Super-mini, 6-pin Typical product: SSM6N36FE  Thickness: 0.55 typ. Unit: mm
US6 (SOT-353)(SC-88A) Ultra-Super-mini, 6-pin Typical product: SSM6N15AFU  Thickness: 0.9 typ. Unit: mm	UF6 Ultra Super mini Flat lead 6-pin Typical product: SSM6J409TU  Thickness: 0.7 typ. Unit: mm	SOT-23F SOT-23 Flat lead Typical product: SSM3J327R  Thickness: 0.8 typ. Unit: mm	UDFN6 Ultra Small Dual Flat Non-leaded 6-pin Typical product: SSM6G18NU  Thickness: 0.75 typ. Unit: mm	UDFN6B Ultra Small Dual Flat Non-leaded 6-pin Typical product: SSM6J501NU  Thickness: 0.75 typ. Unit: mm

TPC Series

The TPC Series comes in small, thin packages suitable for portable devices. The latest TSON Advance package allows the maximum permissible power dissipation equivalent to SOP-8, but occupies 64% less board space.

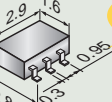
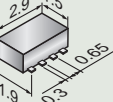
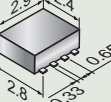
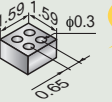
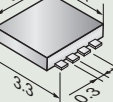
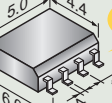
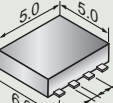
VS-6 Very Thin & Small, 6-pin Typical product: TPC6113  Thickness: 0.75 typ. Unit: mm	VS-8 Very Thin & Small, 8-pin Typical product: TPCF8107  Thickness: 0.8 typ. Unit: mm	PS-8 Progressive & Small 8-pin Series Typical product: TPCP8405  Thickness: 0.8 typ. Unit: mm	Chip LGA Land Grid Array Typical product: TPCL4201  Thickness: 0.25 typ. Unit: mm	TSON Advance Typical product: TPC8062-H  Thickness: 0.85 typ. Unit: mm
SOP-8 Typical product: TPC8074  Thickness: 1.6 typ. Unit: mm	SOP Advance Typical product: TPCA8055-H  Thickness: 0.95 typ. Unit: mm			

4-2 Application Examples and Block Diagrams

Cell Phone (Power Supply Circuit)

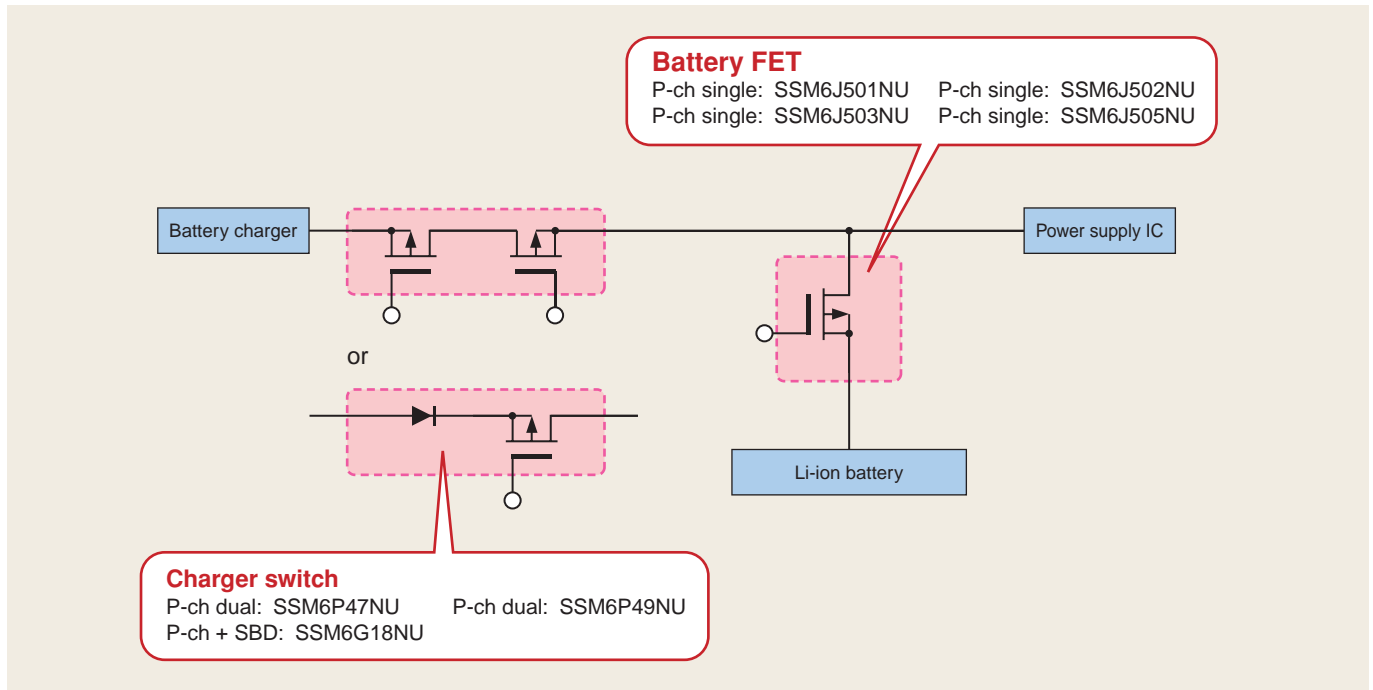

Notebook PC (Power Supply Circuit)

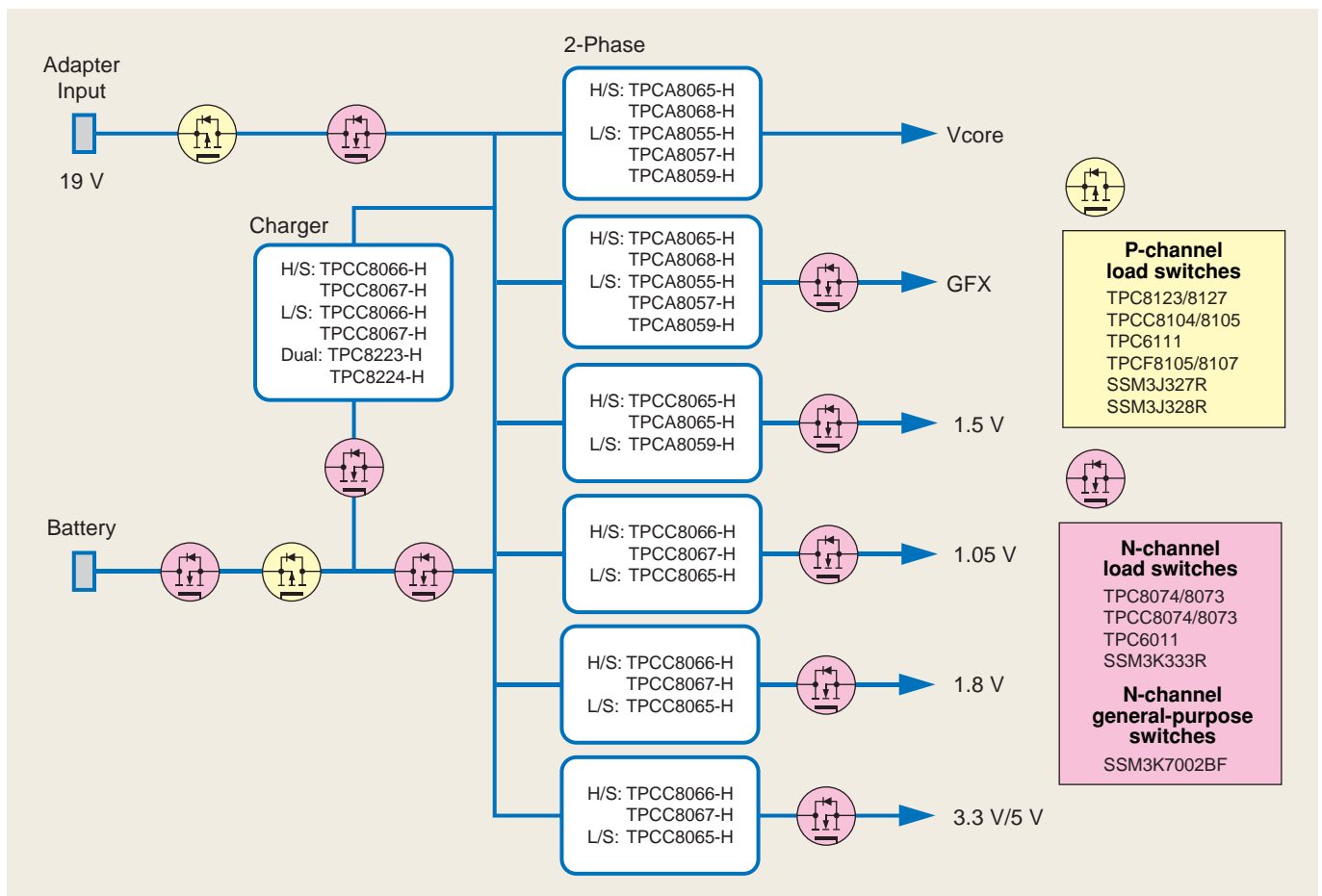

4-2 Application Examples and Block Diagrams

Lithium-Ion Secondary Battery (Battery Protection Circuits)

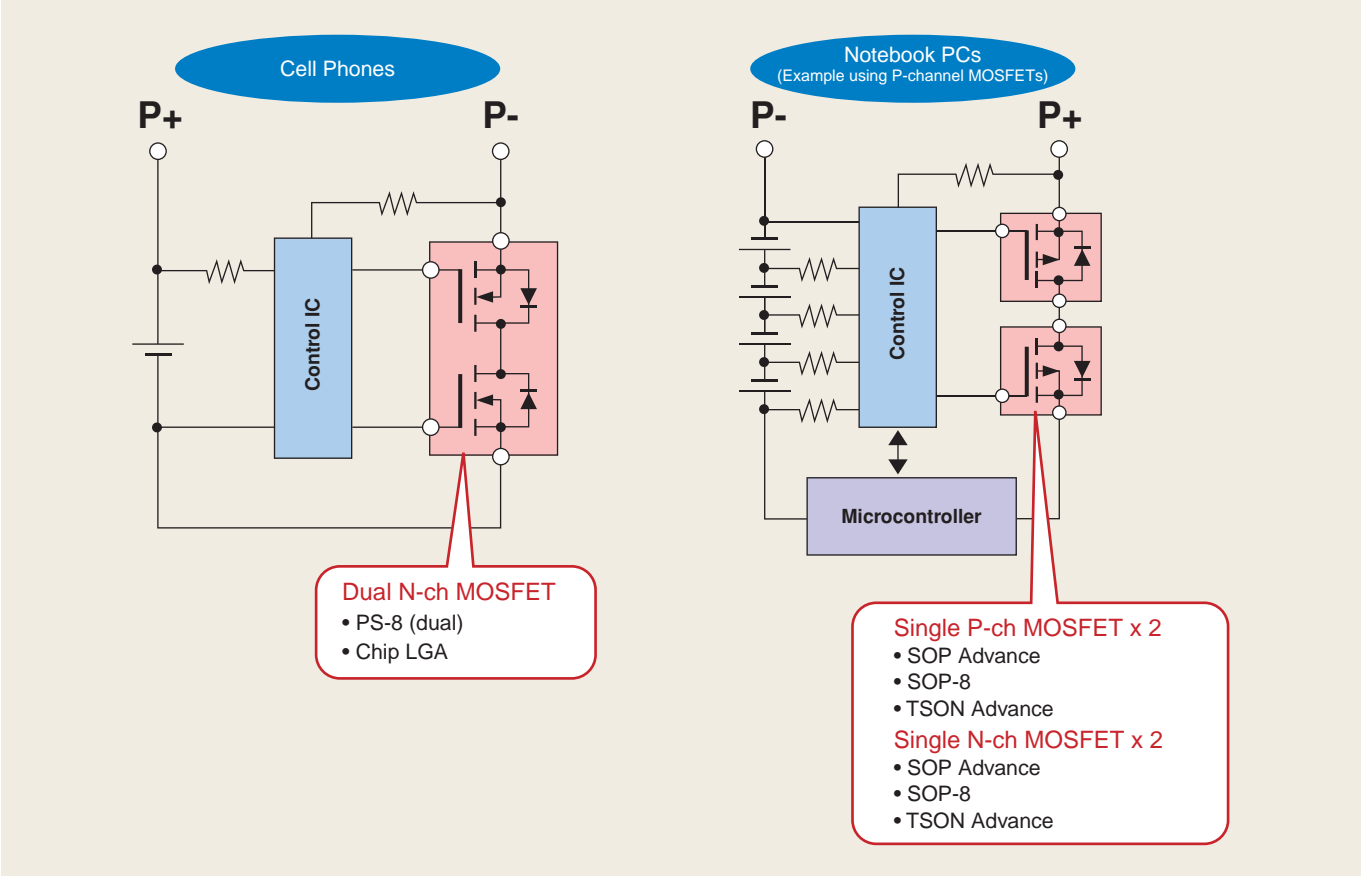

Motor Driver (Power Driver Circuit)

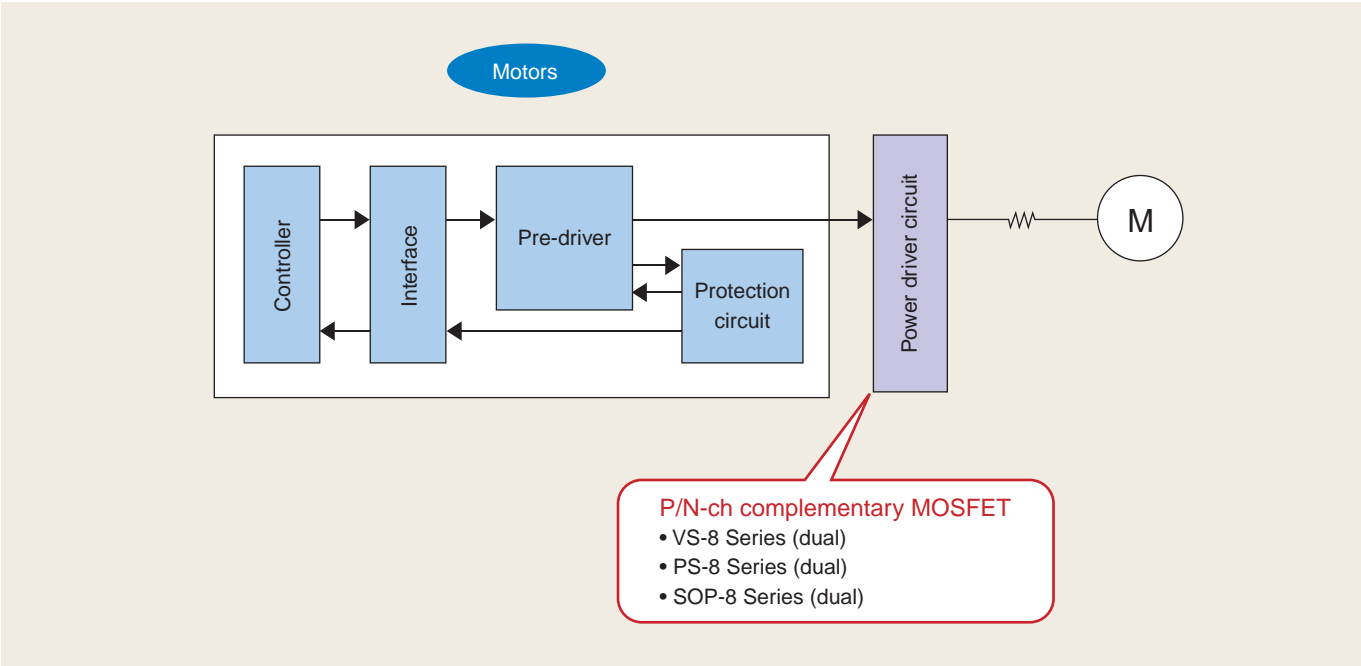

4-3 Low- V_{DSS} MOSFET Roadmaps

Roadmap for Trench MOSFETs

High-Speed, Low- V_{DSS} U-MOS

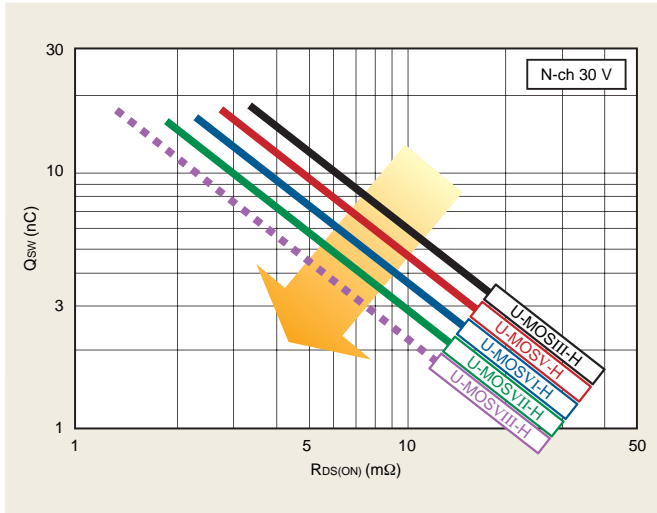

Technology Trend of Low-Voltage U-MOS (Low R_{on})

Continued reduction of on-resistance achieved by employing the latest microfabrication technology

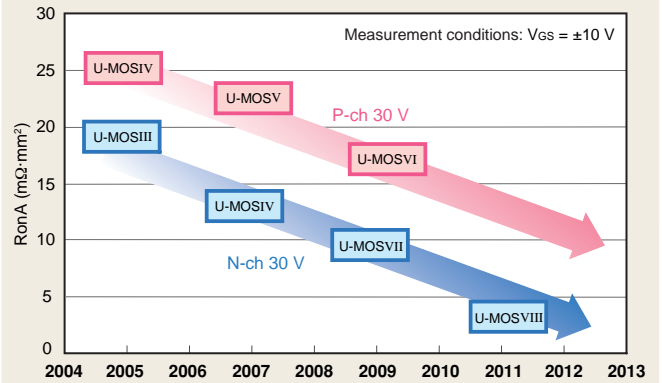

Package Options

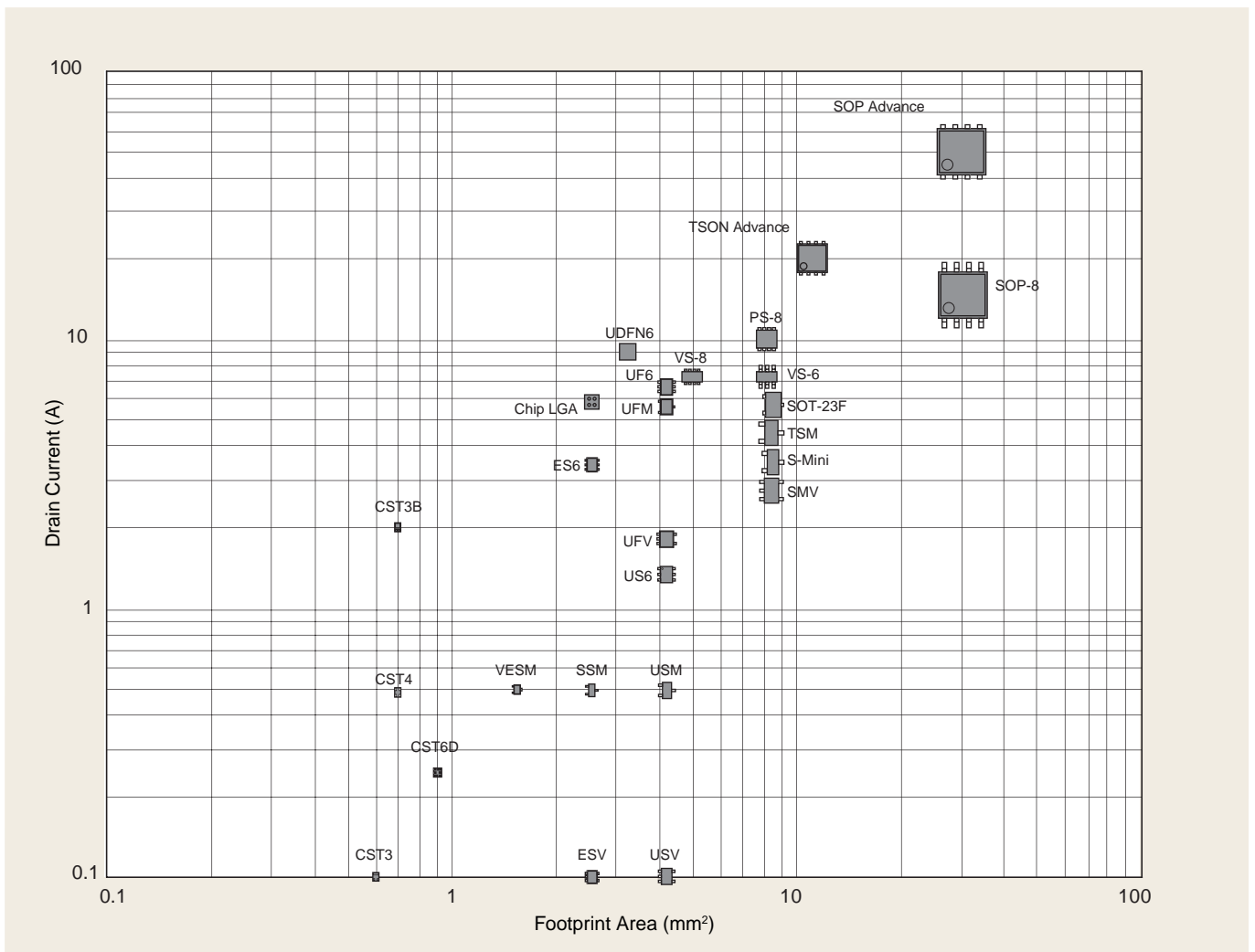

■ Ultra-Small Packages

	S-Mini	USM	SSM	VESM	CST3	US6	USV	ESV	CST6D
Footprint Area	7.3 mm ²	4.2 mm ²	2.6 mm ²	1.4 mm ²	0.6 mm ²	4.2 mm ²	4.2 mm ²	2.6 mm ²	0.9 mm ²
Permissible Power Dissipation (Note)	0.2 W	0.2 W	0.1 W	0.15 W	(Note2) 0.1 W	0.2 W	0.2 W	0.15 W	(Note2) 0.14 W
Height (Max)	1.4 mm	1.1 mm	0.9 mm	0.55 mm	0.4 mm	1.1 mm	1.1 mm	0.6 mm	0.4 mm

Note: Mounted on FR4 Board (25.4 mm x 25.4 mm) Note2: Mounted on FR4 Board (10 mm x 10 mm)

■ Thermally Enhanced Compact Packages

	TSM	UF6	SMV	UFV	UFM	ES6	CST3B	CST4	SOT-23F	UDFN6/ UDFN6B
Footprint Area	8.1 mm ²	4.2 mm ²	8.1 mm ²	4.2 mm ²	4.2 mm ²	2.6 mm ²	1.0 mm ²	1.0 mm ²	7.0 mm ²	4.0 mm ²
Permissible Power Dissipation (Note)	0.7 W	0.5 W	0.75 W	0.5 W	0.5 W	0.5 W	1.0 W	0.4 W	1.0 W	1.0 W
Height (Max)	0.85 mm	0.75 mm	1.4 mm	0.75 mm	0.75 mm	0.6 mm	0.5 mm	0.4 mm	0.88 mm	0.8 mm

Note: Mounted on FR4 Board (25.4 mm x 25.4 mm)

■ Thermally Enhanced Packages

	SOP Adv.	SOP-8	TSON Adv.
Footprint Area	30 mm ²	30 mm ²	10.9 mm ²
Permissible Power Dissipation (Note)	2.8 W	1.9 W	1.9 W
Height	1.0 mm	1.9 mm	0.9 mm

Note: Mounted on FR4 Board (25.4 mm x 25.4 mm)

■ Compact Packages

	VS-8	VS-6	PS-8	Chip LGA
Footprint Area	5.5 mm ²	8.1 mm ²	8.1 mm ²	2.56 mm ²
Permissible Power Dissipation (Note)	2.5 W	2.2 W	—	—
Height	0.85 mm	0.85 mm	0.85 mm	0.25 mm

Note: Mounted on FR4 Board (25.4 mm x 25.4 mm)

4-4 Low- V_{DS} , High-Speed MOSFETs

Synchronous Rectification DC-DC Converters – Block Diagram, Timing Chart and Power Loss Factors

Block Diagram

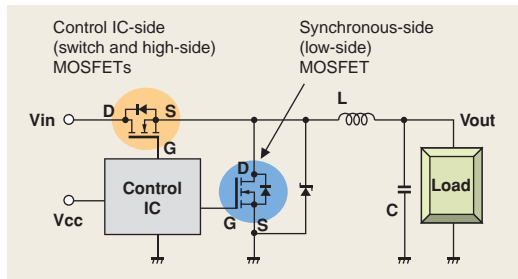

Timing Chart

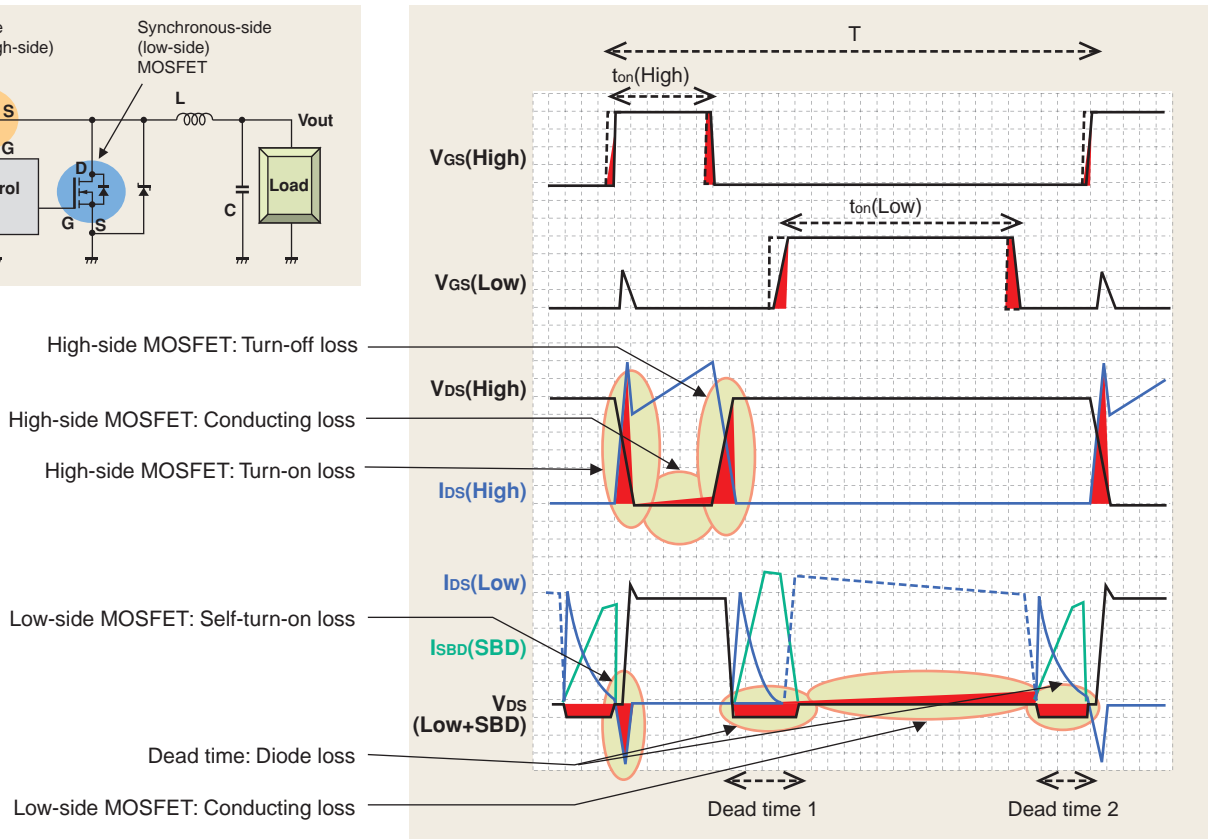

Synchronous Rectification DC-DC Converters

– Summary Results of Power Loss Simulation and Key Parameters for MOSFETs

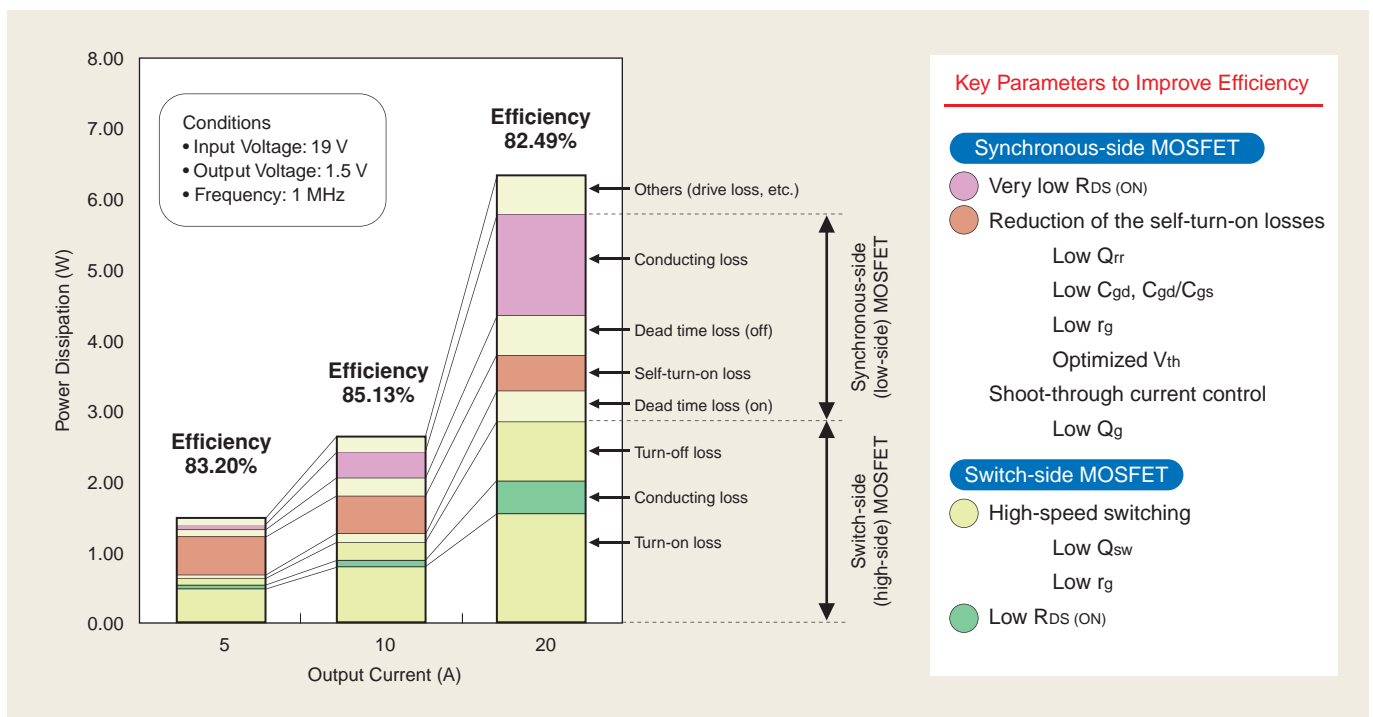

● Synchronous Rectification DC-DC Converters – Efficiency Improvement by Thermally Enhanced Package and New Process Technology

■ Thermally Enhanced Package

In addition to the "SOP Advance", Toshiba has developed "TSON Advance" package which keeps equivalent power dissipation while reducing the footprint area by 64% compared to the industry-standard SOP-8 package.

Toshiba offers a variety of packages that can realize high-power density.

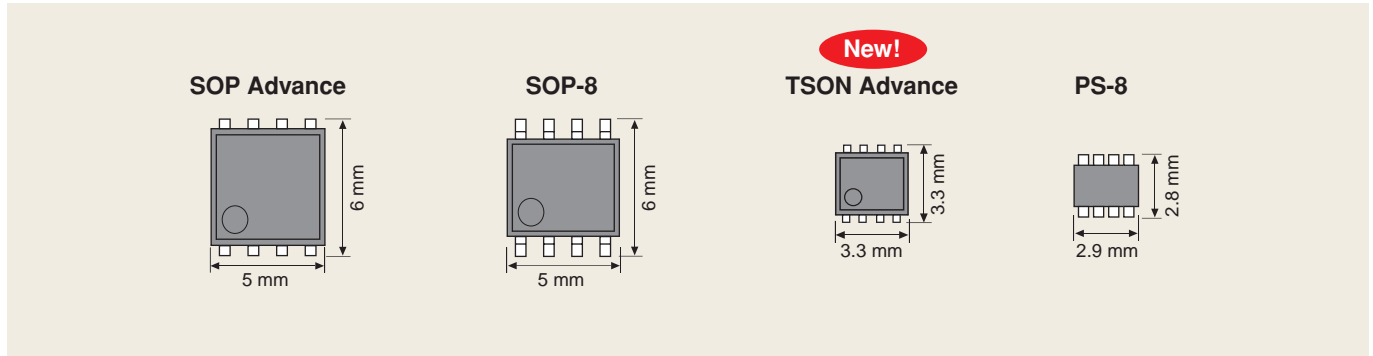

	SOP Advance	SOP-8	TSON Advance	PS-8
Footprint Area	30 mm ²	30 mm ²	10.9 mm ² (-64%)	8.1 mm ² (-73%)
Power Dissipation	2.8 W (+47%)	1.9 W	1.9 W	1.68 W (-12%)
Height	1.0 mm (-47%)	1.9 mm	0.9 mm (-53%)	0.85 mm (-55%)

Percentage relative to SOP-8

■ New Process Technology

Toshiba has developed a new process technology to further reduce an internal gate resistance (r_g) and gate capacitance ratio (C_{gd}/C_{gs}) for minimizing the self-turn-on loss while maintaining both the low on-resistance and low gate charge characteristics.

	$R_{DS(ON)}$ Typ. @4.5 V (m Ω)	r_g Typ. (Ω)	C_{gd}/C_{gs} Typ. (%)
TPCA8055-H (U-MOSVII-H) New Product	1.9	1.4	6.0
TPCA8028-H (U-MOSVI-H)	2.3	1.0	6.8
TPCA8019-H (U-MOSV-H)	3.1	1.0	6.6

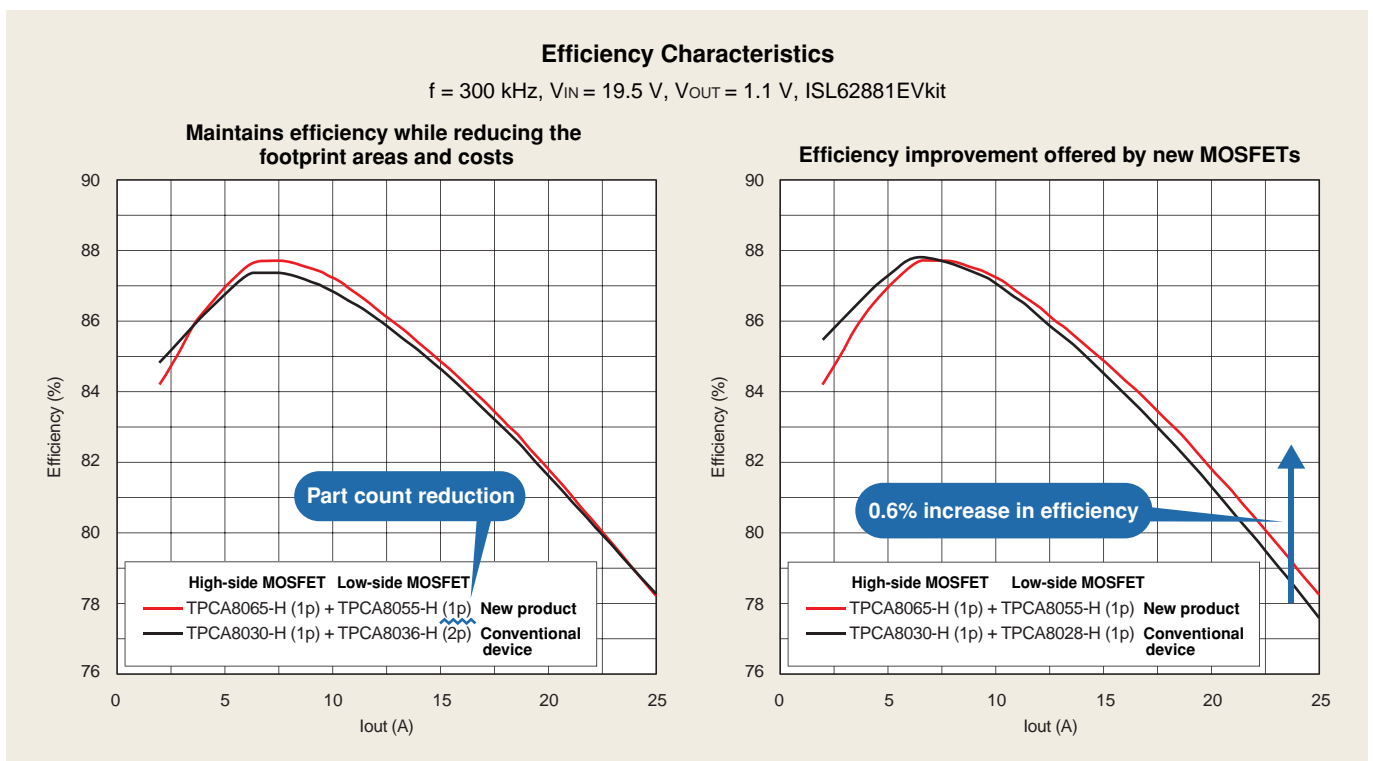

Synchronous Rectification DC-DC Converters – MOSBD (MOSFET with SBD)

External SBD

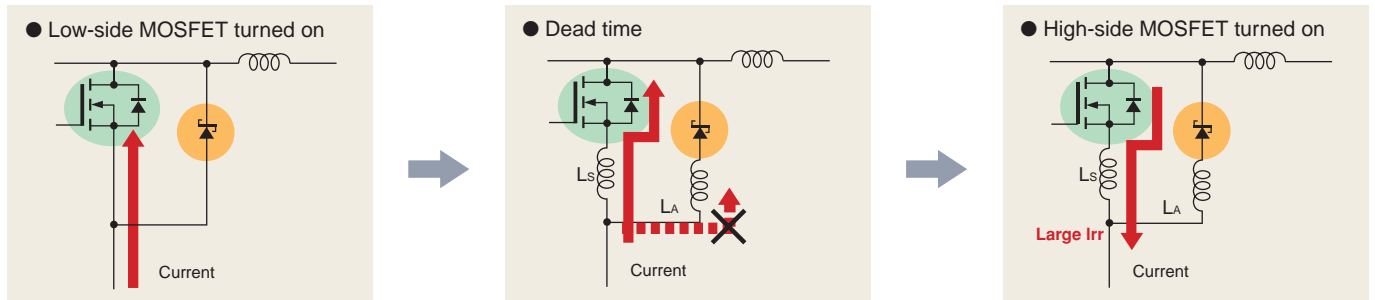

When an SBD is added externally, the SBD can't function fully due to the influence of wire inductances (L_s and L_A); thus a body diode current during the dead time becomes larger and causes the following penalties.

- 1: Increase in the conducting loss of the body diode
- 2: Increase in the reverse recovery loss due to high di/dt
- 3: Induces a self-turn-on phenomenon due to high di/dt

MOSFET with SBD (MOSBD)

A MOSFET with SBD using a monolithic structure reduces a wire inductance (L_A) and a parasitic inductance (L_s). This structure makes it possible for the SBD to function fully and to reduce losses.

Current Waveform Simulation

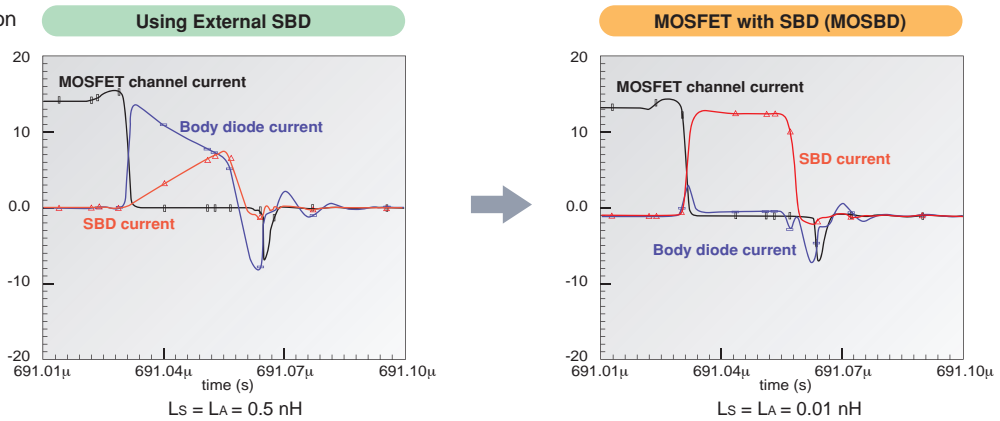

Efficiency Characteristics

$f = 300 \text{ kHz}$, $V_{IN} = 19.5 \text{ V}$, $V_{OUT} = 1.1 \text{ V}$, ISL62881EVkit

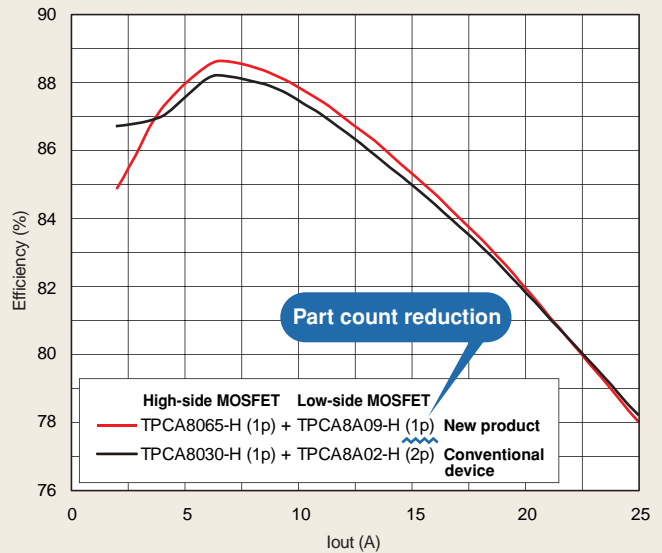
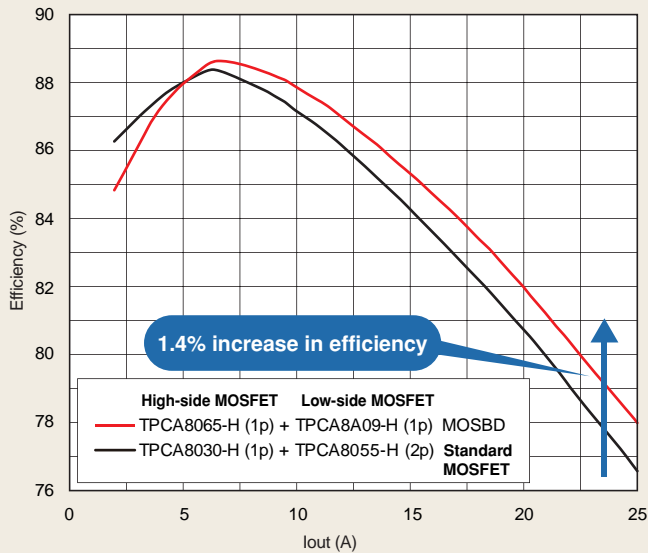

● High-Speed MOSFET Lineup

Circuit Configuration		Absolute Maximum Ratings			Part Number	Package	$R_{DS(ON)}$ Max (m Ω)			Q_{sw} Typ.(nC) @ $V_{DSS} = V_{DSS} \times 0.8$	C_{iss} (pF)	Series		
		V_{DSS} (V)	V_{GSS} (V)	I_D (A)			$I_{VGS1} = 10$ V	$I_{VGS1} = 4.5$ V	$I_{VGS1} = 2.5$ V					
N-ch	Single	20	± 12	40	TPCA8011-H #	SOP Advance	—	3.5	7.5	16	2900	U-MOSIII-H		
			± 20	5.9	TPC6008-H	VS-6	60	74	—	0.9	232	U-MOSVI-H		
		30	± 20	8	TPCC8061-H	TSON Advance	26	29	—	3.5	630	U-MOSVI-H		
			± 20	9	TPCC8067-H		25	33	—	1.9	690	U-MOSVII-H		
			± 20	11	TPCC8066-H		15	19	—	3.2	1100	U-MOSVII-H		
			± 20	13	TPCC8068-H		11.6	16	—	3.3	980	U-MOSVII-H		
			± 20	13	TPCC8065-H		11.4	14.5	—	4.3	1350	U-MOSVII-H		
			± 20	19	TPCC8064-H		8.2	10.6	—	5	1600	U-MOSVII-H		
			± 20	27	TPCC8062-H		5.6	7.1	—	7.4	2400	U-MOSVII-H		
			± 20	9	TPC8067-H		SOP-8	25	33	—	1.9	690	U-MOSVII-H	
			± 20	11	TPC8066-H	16		19	—	3.2	1100	U-MOSVII-H		
			± 20	13	TPC8065-H	11.8		14.9	—	4.3	1350	U-MOSVII-H		
			± 20	16	TPC8064-H	8.4		10.8	—	5	1600	U-MOSVII-H		
			± 20	17	TPC8063-H	7		8.9	—	5.9	1900	U-MOSVII-H		
			± 20	18	TPC8062-H	5.8		7.3	—	7.4	2400	U-MOSVII-H		
			± 20	18	TPC8059-H	4.0		5.0	—	9.1	2900	U-MOSVII-H		
			± 20	18	TPC8058-H	3.2		4.0	—	12	3600	U-MOSVII-H		
			± 20	18	TPC8057-H	2.8		3.4	—	14	4300	U-MOSVII-H		
			± 20	18	TPC8056-H	2.4		2.9	—	17	5200	U-MOSVII-H		
			40	± 20	18	TPC8055-H	SOP Advance	2.1	2.5	—	21	6400	U-MOSVII-H	
		± 20		15	TPCA8068-H	11.6		16	—	3.3	980	U-MOSVII-H		
		± 20		16	TPCA8065-H	11.4		14.5	—	4.3	1350	U-MOSVII-H		
		± 20		20	TPCA8064-H	8.2		10.6	—	5	1600	U-MOSVII-H		
		± 20		22	TPCA8063-H	6.8		8.7	—	5.9	1900	U-MOSVII-H		
		± 20		28	TPCA8062-H	5.6		7.1	—	7.4	2400	U-MOSVII-H		
		± 20		32	TPCA8059-H	3.8		4.8	—	9.1	2900	U-MOSVII-H		
		± 20		38	TPCA8058-H	3		3.8	—	12	3600	U-MOSVII-H		
		± 20		42	TPCA8057-H	2.6		3.2	—	14	4300	U-MOSVII-H		
		± 20		48	TPCA8056-H	2.2		2.7	—	17	5200	U-MOSVII-H		
		± 20		56	TPCA8055-H	1.9	2.3	—	21	6400	U-MOSVII-H			
		40		± 20	40	TK40P03M1	DPAK	10.8	14.4	—	5.7	1150	U-MOSVI-H	
				± 20	45	TK45P03M1		9.7	12	—	8	1500	U-MOSVI-H	
				± 20	50	TK50P03M1		7.5	9.8	—	8.2	1700	U-MOSVI-H	
				± 20	60	TK60P03M1		6.4	7.8	—	13	2700	U-MOSVI-H	
				± 20	5.3	TPC6009-H	VS-6	81	98	—	1.0	225	U-MOSVI-H	
				40	± 20	12	TPC8052-H	SOP-8	11.5	13.3	—	6.6	1620	U-MOSVI-H
					± 20	16	TPC8047-H		7.6	8.8	—	11	2590	U-MOSVI-H
			± 20		18	TPC8046-H	5.7		6.6	—	15	3545	U-MOSVI-H	
			± 20		18	TPC8045-H	3.9		4.4	—	23	5800	U-MOSVI-H	
			± 20		20	TPCA8052-H	SOP Advance	11.3	13.1	—	6.6	1620	U-MOSVI-H	
		± 20	32		TPCA8047-H	7.3		8.5	—	13	2590	U-MOSVI-H		
		± 20	38		TPCA8046-H	5.4		6.3	—	15	3545	U-MOSVI-H		
		± 20	46		TPCA8045-H	3.6		4.1	—	23	5800	U-MOSVI-H		
		± 20	20	TK20P04M1	DPAK	29	34	—	3.7	985	U-MOSVI-H			
		± 20	40	TK40P04M1		11	13.4	—	7.4	1920	U-MOSVI-H			
		± 20	50	TK50P04M1		8.7	10.2	—	9.4	2600	U-MOSVI-H			

#: With protection Zener diode between gate and source

Circuit Configuration		Absolute Maximum Ratings			Part Number	Package	R _{DS(ON)} Max (mΩ)				Q _{sw} Typ. (nC) @ V _{DS} = V _{DSS} x 0.8	C _{iss} (pF)	Series	
		V _{DSS} (V)	V _{GSS} (V)	I _D (A)			I _{VGS1} = 10 V	I _{VGS1} = 6 V	I _{VGS1} = 4.5 V	I _{VGS1} = 2.5 V				
N-ch	Single	60	±20	6.1	TPC6010-H	VS-6	59	—	63	—	2.7	640	U-MOSVI-H	
			±20	5	TPCP8007-H	PS-8	57	—	64	—	2.7	640	U-MOSVI-H	
			±20	9	TPC8053-H	SOP-8	22.5	—	24.2	—	6.7	1620	U-MOSVI-H	
			±20	11	TPC8050-H		14.5	—	15.6	—	9.2	2590	U-MOSVI-H	
			±20	13	TPC8049-H		10.7	—	11.5	—	13	3545	U-MOSVI-H	
			±20	16	TPC8048-H		6.9	—	7.4	—	17	5800	U-MOSVI-H	
			±20	15	TPCA8053-H	SOP Advance	22.3	—	24	—	6.9	1620	U-MOSVI-H	
			±20	(14)	TPH14006NH		(14)	(19)	—	—	(6.3)	(1020)	U-MOSVIII-H	
			±20	(22)	TPH7R506NH		(7.5)	(33)	—	—	(14)	(1785)	U-MOSVIII-H	
			±20	24	TPCA8050-H		14.2	—	15.3	—	10	2590	U-MOSVI-H	
			±20	28	TPCA8049-H		10.4	—	11.2	—	13	3545	U-MOSVI-H	
			±20	(28)	TPH5R906NH		(5.9)	(14)	—	—	(18)	(3100)	U-MOSVIII-H	
			±20	(32)	TPH4R606NH	(4.6)	(11)	—	—	(19)	(3050)	U-MOSVIII-H		
			±20	35	TPCA8048-H	6.6	—	7.1	—	19	5800	U-MOSVI-H		
	Dual	80	±20	13	TPC8051-H	SOP-8	9.7	—	10.1	—	16	5800	U-MOSVI-H	
			±20	28	TPCA8051-H	SOP Advance	9.4	—	9.8	—	18	5800	U-MOSVI-H	
			±20	6.5	TPCP8205-H	PS-8	26	—	29	—	—	830	U-MOSVI-H	
			30	±20	8	TPC8224-H	SOP-8	26	—	34	—	1.9	690	U-MOSVII-H
				±20	9	TPC8223-H		17	—	21	—	3.6	1100	U-MOSVII-H
				±20	TBD	TPC8227-H		(33)	—	(40)	—	TBD	640	U-MOSVI-H
±20	TBD	TPC8228-H		(57)	—	(64)		—	TBD	640	U-MOSVI-H			
±20	TBD	TPC8229-H	(80)	—	(87)	—	TBD	640	U-MOSVI-H					
P-ch	Single	-30	±20	-5	TPC6109-H #	VS-6	59	—	83	—	4.8	471	U-MOSIII-H	
MOSBD	Single	30	±20	35	TPCA8A11-H	SOP Advance	3.6	—	4.6	—	10	3200	U-MOSVII-H	
			±20	40	TPCA8A10-H		3.0	—	3.8	—	12	4000	U-MOSVII-H	
			±20	51	TPCA8A09-H		2.3	—	2.8	—	17	5900	U-MOSVII-H	

#: With protection Zener diode between gate and source

4-5 Low- V_{DSS} , Low- $R_{DS(ON)}$ MOSFETs (for Lithium-Ion Battery Protection)

Roadmap of MOSFETs for Lithium-Ion Battery Applications

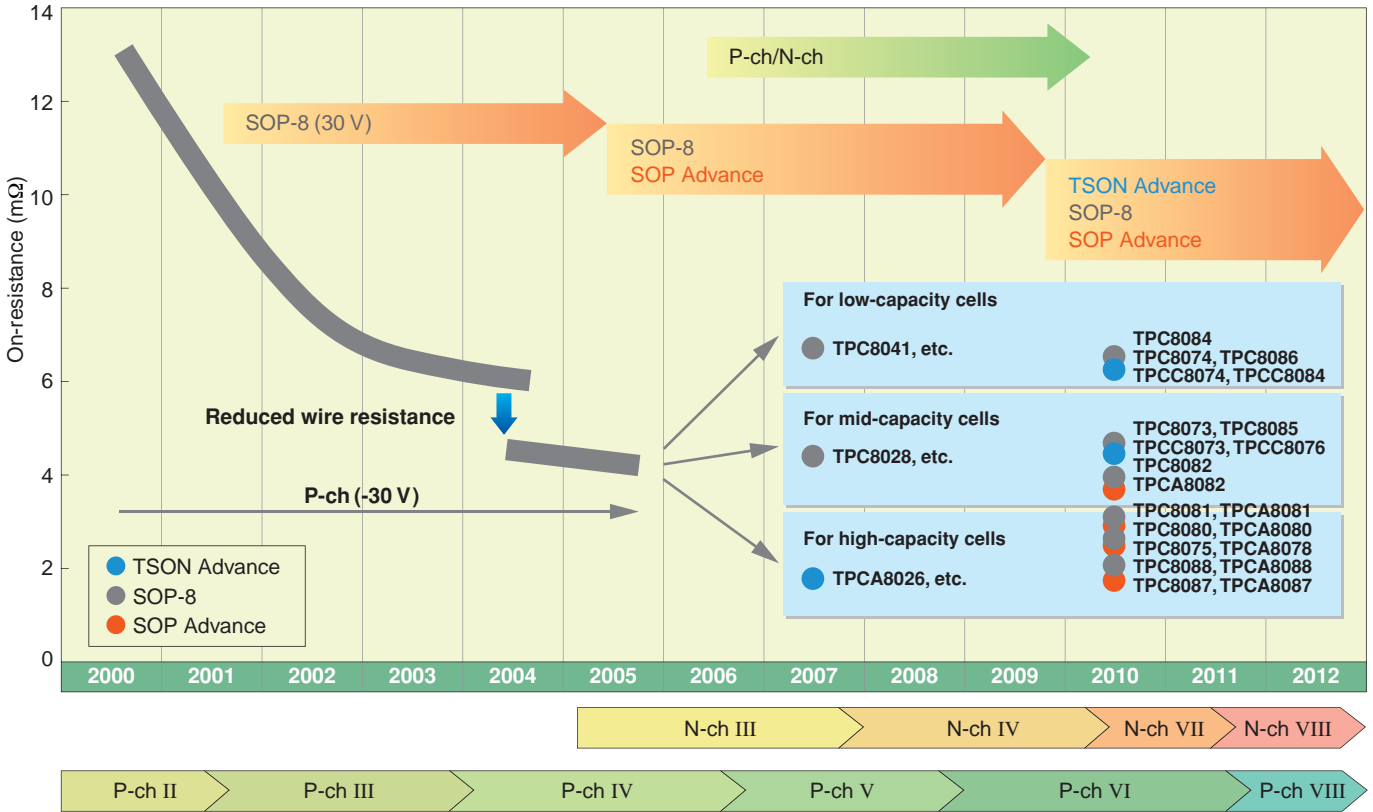

Packaging

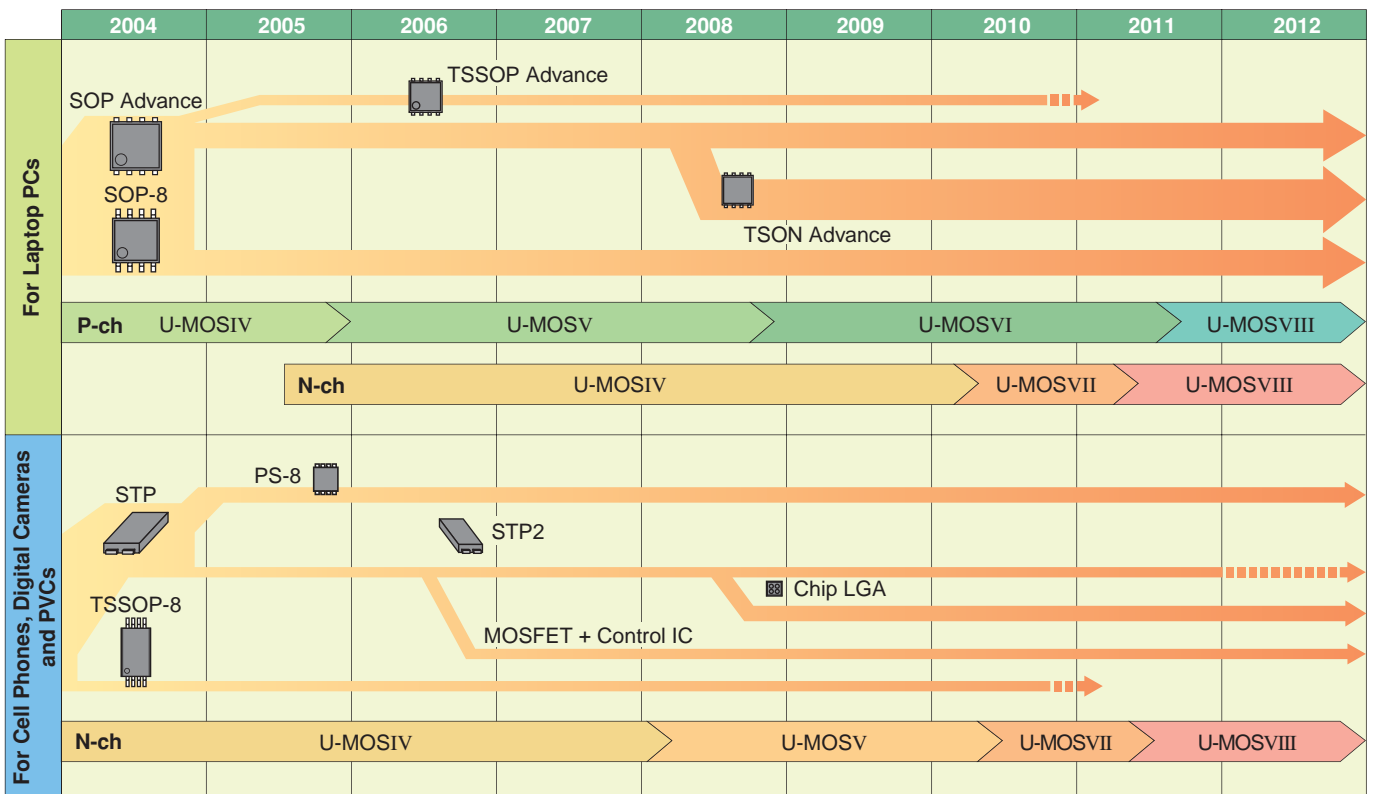

Low-On-Resistance N-Channel Power MOSFETs

Part Number	Absolute Maximum Ratings			Package	Circuit Configuration	R _{DS(ON)} Max (mΩ)				Series
	V _{DSS} (V)	V _{GSS} (V)	I _D (A)			I _{VGS1} = 10 V	I _{VGS1} = 4.5 V	I _{VGS1} = 4.0 V	I _{VGS1} = 2.5 V	
TPCL4201	20	±12	6	Chip LGA	N-ch Dual	—	31	33	52	U-MOSV
TPCL4203	24	±12	6			—	36	38	55	U-MOSV
TPCL4202	30	±12	6			—	40	42	64	U-MOSV
TPCC8093	20	±12	21	TSON Advance	N-ch Single	—	5.8	—	9.5	U-MOSVII
SIDP1	30	±20	TBD			(6.3)	TBD	—	—	U-MOSVIII
SICA7	30	±20	TBD			(4.3)	TBD	—	—	U-MOSVIII
TPCC8068-H	30	±20	13			11.6	16	—	—	U-MOSVII-H
TPCC8065-H	30	±20	13			11.4	14.5	—	—	U-MOSVII-H
TPCC8074	30	±20	20			6.3	8.5	—	—	U-MOSVII
TPCC8073	30	±20	27			4.5	5.9	—	—	U-MOSVII
TPCC8084 #	33	±20	21			6.7	9	—	—	U-MOSVII
TPCC8076 #	33	±20	27			4.6	6.2	—	—	U-MOSVII
TPN2R503NC	30	±20	(40)			(2.5)	(4.1)	—	—	U-MOSVIII
TPC8065-H	30	±20	13			11.6	14.7	—	—	U-MOSVII-H
TPC8092	30	±20	15			9	11.1	—	—	U-MOSVII
TPC8074	30	±20	17			6.5	8.7	—	—	U-MOSVII
TPC8086 #	30	±20	17			6.4	8.5	—	—	U-MOSVII
TPC8076	30	±20	18			4.9	6.5	—	—	U-MOSVII
TPC8073	30	±20	18			4.7	6.1	—	—	U-MOSVII
TPC8085 #	30	±20	18			4.7	6.1	—	—	U-MOSVII
TPC8082	30	±20	18			4	5	—	—	U-MOSVII
TPC8081	30	±20	18			3.2	4	—	—	U-MOSVII
TPC8080	30	±20	18			2.8	3.4	—	—	U-MOSVII
TPC8088	30	±20	18	2.4	2.9	—	—	U-MOSVII		
TPC8087	30	±20	18	2.1	2.5	—	—	U-MOSVII		
TPC8084 #	33	±20	17	6.9	9.2	—	—	U-MOSVII		
TPC8075	33	±20	18	2.6	3.3	—	—	U-MOSVII		
TPC8078	33	±20	18	2.3	2.8	—	—	U-MOSVII		
TPCA8068-H	30	±20	15	11.6	16	—	—	U-MOSVII-H		
TPCA8082	30	±20	32	3.8	4.8	—	—	U-MOSVII		
TPCA8081	30	±20	38	3	3.8	—	—	U-MOSVII		
TPCA8080	30	±20	42	2.6	3.2	—	—	U-MOSVII		
TPCA8088	30	±20	48	2.2	2.7	—	—	U-MOSVII		
TPCA8087	30	±20	56	1.9	2.3	—	—	U-MOSVII		
TPCA8075	33	±20	48	2.4	3.1	—	—	U-MOSVII		
TPCA8078	33	±20	54	2.1	2.6	—	—	U-MOSVII		

#: With protection Zener diode between gate and source

Low-On-Resistance P-Channel Power MOSFETs





Part Number	Absolute Maximum Ratings			Package	Circuit Configuration	R _{DS(ON)} Max (mΩ)				Series
	V _{DSS} (V)	V _{GSS} (V)	I _D (A)			I _{VGS1} = 10 V	I _{VGS1} = 4.5 V	I _{VGS1} = 4 V	I _{VGS1} = 2.5 V	
TPCC8136	-20	±12	-9.4	TSON Advance	P-ch Single	—	16	—	21	U-MOSVI
TPCC8137	-20	±12	-13			—	10	16	30	U-MOSVIII
TPCC8138	-20	±12	-18			—	7.5	11	21	U-MOSVIII
TPCC8131	-30	±20	-10			17.6	23	—	—	U-MOSVI
TPCC8103	-30	±20	-18			12	—	25	—	U-MOSV
TPCC8104	-30	-25/+20	-20			8.8	12.4	—	—	U-MOSVI
TPCC8105	-30	-25/+20	-23			7.8	10.4	—	—	U-MOSVI
TPC8129	-30	-25/+20	-9			22	28	—	—	U-MOSVI
TPC8125	-30	-25/+20	-10			13	17	—	—	U-MOSVI
TPC8126	-30	-25/+20	-11			10	14	—	—	U-MOSVI
TPC8123	-30	-25/+20	-11	SOP-8	P-ch Single	9	12.5	—	—	U-MOSVI
TPC8127	-30	-25/+20	-13			6.5	8.9	—	—	U-MOSVI
TPC8128	-30	-25/+20	-16			5	6.9	—	—	U-MOSVI
TPC8117	-30	±20	-18			3.9	—	7.9	—	U-MOSV
TPC8120	-30	-25/+20	-18			3.2	4.2	—	—	U-MOSVI
TPC8134	-40	-25/+20	-5			52	66	—	—	U-MOSVI
TPC8132	-40	-25/+20	-7			25	33	—	—	U-MOSVI
TPC8133	-40	-25/+20	-9			15	18	—	—	U-MOSVI
TPC8124	-40	-25/+20	-12			8	10	—	—	U-MOSVI
TPCA8131	-30	-25/+20	-13			17	22	—	—	U-MOSVI
TPCA8109	-30	-25/+20	-24	SOP Advance	P-ch Single	9	13	—	—	U-MOSVI
TPCA8128	-30	-25/+20	-40			4.8	6.7	—	—	U-MOSVI
TPCA8106	-30	±20	-40			3.7	—	7.8	—	U-MOSV
TPCA8120	-30	-25/+20	-45			3	4	—	—	U-MOSVI

#: With protection Zener diode between gate and source

4-6 Low- V_{DS} MOSFET Lineup

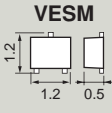
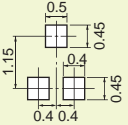
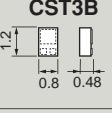
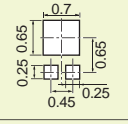
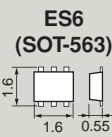
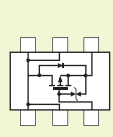
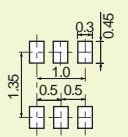
Semi-Power P-Channel Single MOSFETs

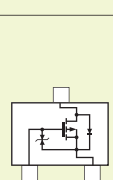
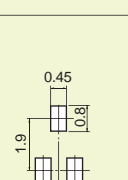
Unit: mm

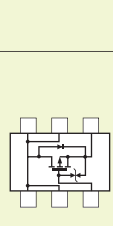
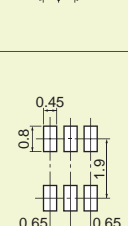
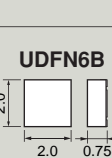
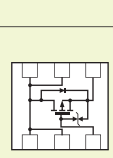
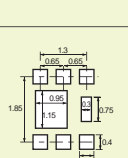
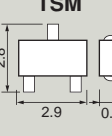
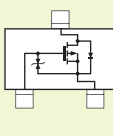
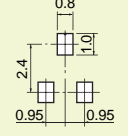
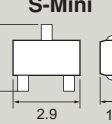
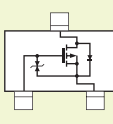
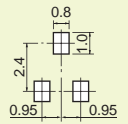



Package	Part Number	V_{BS} (V)	V_{GS} (V)	I_D (A)	$R_{DS(ON)}$ Max (m Ω)					C_{iss} (pF)	Series	*Internal Connections	Land Pattern Example ^(Note)
					$I_{V_{GS1}} = 1.2$ V	$I_{V_{GS1}} = 1.5$ V	$I_{V_{GS1}} = 1.8$ V	$I_{V_{GS1}} = 2.5$ V	$I_{V_{GS1}} = 4.5$ V				
	SSM3J56MFV	-20	± 8	-0.8	4000	900	660	480	390	100	U-MOSVI		
	SSM3J46CTB	-20	± 8	-2.0	—	250	178	133	103	290	U-MOSVI		
	SSM6J212FE	-20	± 8	-4.0	—	94.0	65.4	49.0	40.7	970	U-MOSVI		
	SSM6J215FE	-20	± 8	-3.4	—	154	104	79	59	630	U-MOSVI		
	SSM6J214FE	-30	± 12	-3.6	—	—	149.6	77.6	57	560	U-MOSVI		
	SSM6J213FE	-20	± 8	-2.6	—	250	178	133	103	290	U-MOSVI		
	SSM6J207FE	-30	± 20	-1.4	—	—	—	—	491(@4V)	137	U-MOSII		
	SSM3J132TU	-12	± 6	-5.4	94	39	29	21	17	2700	U-MOSVI		
	SSM3J130TU	-20	± 8	-4.4	—	63.2	41.1	31	25.8	1800	U-MOSVI		
	SSM3J133TU	-20	± 8	-5.5	—	88.4	56	39.7	29.8	840	U-MOSVI		
	SSM3J134TU	-20	± 8	-3.2	—	240	168	123	93	290	U-MOSVI		
	SSM3J135TU	-20	± 8	-3.0	—	260	180	132	103	270	U-MOSVI		
	SSM3J113TU	-20	± 12	-1.7	—	—	—	249	169(@4V)	370	U-MOSIII		
	SSM3J117TU	-30	± 20	-2.0	—	—	—	—	225(@4V)	280	U-MOSII		
	SSM3J118TU	-30	± 20	-1.4	—	—	—	—	480(@4V)	137	U-MOSII		
	SSM3J112TU	-30	± 20	-1.1	—	—	—	—	790(@4V)	86	U-MOSII		
	SSM6J414TU*	-20	± 8	-6	—	54	36	26	22.1	1700	U-MOSVI		
	SSM6J409TU	-20	± 8	-9.5	—	72.3	46.2	30.2	22.1	1100	U-MOSV		
	SSM6J412TU	-20	± 8	-4.0	—	99.6	67.8	51.4	42.7	840	U-MOSVI		
	SSM6J50TU	-20	± 10	-2.5	—	—	205(@2.0V)	100	64	800	U-MOSIV		
	SSM6J401TU	-30	± 20	-2.5	—	—	—	—	145(@4V)	730	U-MOSIII		
	SSM6J402TU	-30	± 20	-2.0	—	—	—	—	225(@4V)	280	U-MOSIII		
	SSM6J505NU*	-12	± 6	-10	70	23	20	15	12	3000	U-MOSVI		
	SSM6J501NU	-20	± 8	-10	—	43	26.5	19	15.3	2600	U-MOSVI		
	SSM6J502NU	-20	± 8	-6.0	—	60.5	38.4	28.3	23.1	1800	U-MOSVI		
	SSM6J503NU	-20	± 8	-6.0	—	89.6	57.9	41.7	32.4	840	U-MOSVI		
	SSM3J328R	-20	± 8	-6.0	—	88.4	56.0	39.7	29.8	840	U-MOSVI		
SSM3J331R	-20	± 8	-4.0	—	150	100	75	55	630	U-MOSVI			
SSM3J327R	-20	± 8	-3.9	—	240	168	123	93	290	U-MOSVI			
SSM3J332R	-30	± 12	-6.0	—	—	144	72	50	560	U-MOSVI			
SSM3J334R	-30	± 20	-4.0	—	—	—	—	105	280	U-MOSVI			
	SSM3J326T	-30	± 12	-5.6	—	—	115	62.5	45.7	650	U-MOSVI		
	SSM3J314T	-30	± 20	-3.5	—	—	—	—	100(@4V)	505	U-MOSIII-H		
	SSM3J306T	-30	± 20	-2.4	—	—	—	—	225(@4V)	280	U-MOSII		
	SSM3J305T	-30	± 20	-1.7	—	—	—	—	477(@4V)	137	U-MOSII		
	SSM3J325F	-20	± 8	-2.0	—	311	231	179	150	270	U-MOSVI		

*: Under development (All specs are preliminary.)

* The internal connection diagrams only show the general configurations of the circuits. Note: For reference only. Land pattern dimensions should be determined empirically.

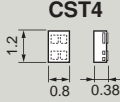
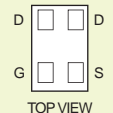
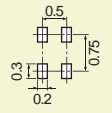
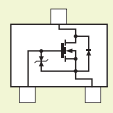
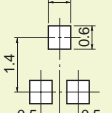
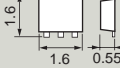
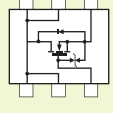
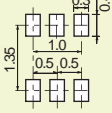
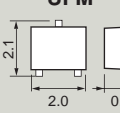
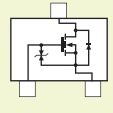
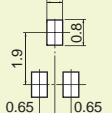
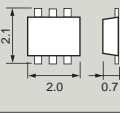
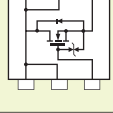
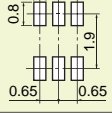
Semi-Power N-Channel Single MOSFETs

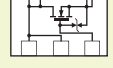
Unit: mm

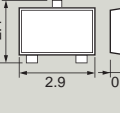
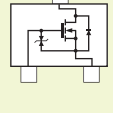
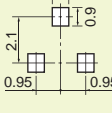
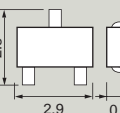
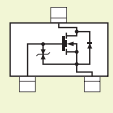
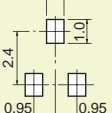
Package	Part Number	V _{DSS} (V)	V _{GSS} (V)	I _b (A)	R _{DS(ON)} Max (mΩ)				C _{iss} (pF)	Series	*Internal Connections	(Note) Land Pattern Example
					I _{VGS1} = 1.5 V	I _{VGS1} = 1.8 V	I _{VGS1} = 2.5 V	I _{VGS1} = 4.0 V				
CST4 	SSM4K27CT	20	±12	0.5	—	390	260	205	174	U-MOSIII		
		20	±8	0.8	790	420	330	260 (@4.5 V)	63	U-MOSVII-H		
ES6 (SOT-563) 	SSM6K211FE	20	±10	3.2	118	82	59	47(@4.5 V)	510	U-MOSIII		
	SSM6K202FE	30	±12	2.3	—	145	101	85	270	U-MOSIII		
	SSM6K204FE	20	±10	2.0	307	214	164	126	195	U-MOSIII		
	SSM6K208FE	30	±12	1.9	—	296	177	133	123	U-MOSIII		
	SSM6K210FE	30	±20	1.4	—	—	—	371	57	U-MOSIII		
	SSM6K30FE	20	±20	1.2	—	—	—	420	60	π-MOSVII		
UFM 	SSM3K123TU	20	±10	4.2	66	43	32	28	1010	U-MOSIII		
	SSM3K121TU	20	±10	3.2	140	93	63	48	400	U-MOSIII		
	SSM3K119TU	30	±12	2.5	—	134	90	74	270	U-MOSIII		
	SSM3K122TU	20	±10	2.0	304	211	161	123	195	U-MOSIII		
	SSM3K127TU	30	±12	2.0	—	286	167	123	123	U-MOSIII		
	SSM3K116TU	30	±12	2.2	—	—	135	100(@4.5 V)	245	U-MOSIV		
	SSM3K131TU	30	±20	6.0	—	—	—	41.5(@4.5 V)	450	U-MOSIV		
	SSM3K124TU	30	±20	2.4	—	—	—	120	180	π-MOSVII		
UF6 	SSM6K403TU	20	±10	4.2	66	43	32	28	1050	U-MOSIII		
	SSM6K404TU	20	±10	3.0	147	100	70	55	400	U-MOSIII		
	SSM6K411TU	20	±12	10	—	—	23.8	12(@4.5 V)	710	U-MOSIV		
	SSM6K406TU	30	±20	4.4	—	—	—	38.5(@4.5 V)	490	U-MOSIV		
	SSM6K407TU	60	±20	2.0	—	—	—	440	150	π-MOSV		
UDFN6B 	SSM6K504NU*	30	±20	9	—	—	—	30(@4.5 V)	650	U-MOSVII-H		
SOT-23F 	SSM3K329R	30	±12	3.5	—	289	170	126	123	U-MOSIII		
	SSM3K333R	30	±20	6.0	—	—	—	42(@4.5 V)	436	U-MOSVII-H		
	SSM3K335R*	30	±20	6.0	—	—	—	56(@4.5 V)	340	U-MOSVII-H		
	SSM3K336R*	30	±20	3.0	—	—	—	140(@4.5 V)	126	U-MOSVII-H		
TSM 	SSM3K310T	20	±10	5.0	66	43	32	28	1120	U-MOSIII		
	SSM3K309T	20	±12	4.7	—	47	35	31	1020	U-MOSIII		
	SSM3K301T	20	±12	3.5	—	110	74	56	320	U-MOSIII		
	SSM3K316T	30	±12	4.0	—	131	87	65(@4.5 V)	270	U-MOSIII		
	SSM3K320T	30	±20	4.2	—	—	—	77(@4.5 V)	190	U-MOSIV		
	SSM3K318T	60	±20	2.5	—	—	—	145(@4.5 V)	235	U-MOSIV		

*: Under development (All specs are preliminary.)

* The internal connection diagrams only show the general configurations of the circuits.
Note: For reference only. Land pattern dimensions should be determined empirically.

Semi-Power Dual MOSFETs

Unit: mm

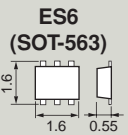
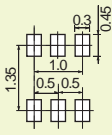
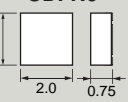
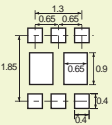
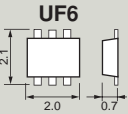
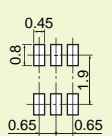
Package	Polarity	Part Number	V_{BSS} (V)	V_{GSS} (V)	I_b (A)	$R_{DS(ON)}$ Max (m Ω)				C_{iss} (pF)	Series	*Internal Connections	(Note) Land Pattern Example
						$I_{V_{GS1}} = 1.5V$	$I_{V_{GS1}} = 1.8V$	$I_{V_{GS1}} = 2.5V$	$I_{V_{GS1}} = 4.0V$				
ES6 (SOT-563) 	N-ch x 2	SSM6N42FE	20	± 10	0.8	600	450	330	240 (@4.5V)	90	U-MOSIII		
	P-ch x 2	SSM6P41FE	-20	± 8	-0.72	1040	670	440	300 (@4.5V)	110	U-MOSV		
	N-ch + P-ch	SSM6L14FE	20	± 10	0.8	600	450	330	240 (@4.5V)	90	U-MOSIII		
-20			± 8	-0.72	1040	670	440	300 (@4.5V)	110	U-MOSV			
UDFN6 	P-ch x 2	SSM6P47NU	-20	± 8	-4	242	170	125	95 (@4.5V)	290	U-MOSVI		
		SSM6P49NU	-20	± 12	-4	—	157	76	56 (@4.5V)	480	U-MOSVI		
	N-ch x 2	SSM6N55NU	30	± 20	4	—	—	—	64 (@4.5V)	280	U-MOSVII-H		
UF6 	N-ch x 2	SSM6N39TU	20	± 10	1.6	247	190	139	119	260	U-MOSIII		
		SSM6N24TU	30	± 12	0.5	—	—	180	145	245	U-MOSIII		
		SSM6N40TU	30	± 20	1.6	—	—	—	182	180	U-MOSIII		
	P-ch x 2	SSM6P54TU	-20	± 8	-1.2	555	350	228	—	331	U-MOSIV		
		SSM6P39TU	-20	± 8	-1.5	—	430	294	213	250	U-MOSIII		
		SSM6P25TU	-20	± 12	-0.5	—	—	430	260	218	U-MOSIII		
		SSM6P40TU	-30	± 20	-1.4	—	—	—	403	120	U-MOSIII		
	N-ch + P-ch	SSM6L39TU	20	± 10	1.6	247	190	139	119	260	U-MOSIII		
			-20	± 8	-1.5	—	430	294	213	250	U-MOSIII		
		SSM6L12TU	30	± 12	0.5	—	—	180	145	245	U-MOSIII		
			-20	± 12	-0.5	—	—	430	260	218	U-MOSIII		
			30	± 20	1.6	—	—	—	182	180	U-MOSIII		
	SSM6L40TU	-30	± 20	-1.4	—	—	—	403	120	U-MOSIII			
SSM6E01TU		-12	± 12	-1.0	—	—	240	160	310	U-MOSIII			
		20	10	0.05	—	—	10 Ω	—	11	π -MOSVI			
P-ch + N-ch (Load Switch)	SSM6E03TU	-20	± 8	-1.8	—	335	180	144	335	U-MOSIII			
		20	± 10	0.1	15 Ω	—	4 Ω	3 Ω	9.3	π -MOSVI			

* The internal connection diagrams only show the general configurations of the circuits.
Note: For reference only. Land pattern dimensions should be determined empirically.

MOSFET with a Schottky Barrier Diode

Unit: mm

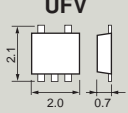
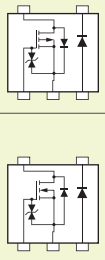
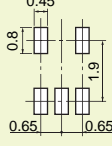
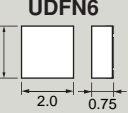
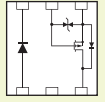
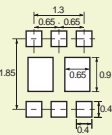
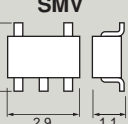
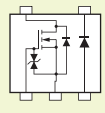
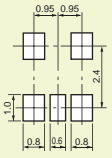
Package	Polarity	Part Number	MOSFET							SBD				*Internal Connections	(Note) Land Pattern Example			
			V _{DSS} (V)	V _{GSS} (V)	I _D (A)	R _{DS(ON)} Max (mΩ)				C _{iss} (pF)	Series	V _R (V)	I _O (A)			V _F Max (V) @ I _F (A)		
						V _{GSL} = 1.5 V	V _{GSL} = 1.8 V	V _{GSL} = 2.5 V	V _{GSL} = 4.0 V									
	P-ch+ SBD	SSM5G09TU	-12	±8	-1.5	—	—	200	130	550	U-MOSII	12	0.5	0.43	0.5			
		SSM5G02TU	-12	±12	-1.0	—	—	240	160	310	U-MOSII	12	0.5	0.43	0.5			
		SSM5G10TU	-20	±8	-1.5	—	—	430	294	213	250	U-MOSIII	20	0.7	0.39			0.5
		SSM5G11TU	-30	±20	-1.4	—	—	—	403	120	U-MOSIII-H	30	0.7	0.41	0.5			
	N-ch+ SBD	SSM5H10TU	20	±10	1.6	247	190	139	119	260	U-MOSIII	20	0.7	0.39	0.5			
		SSM5H16TU	30	±12	1.9	—	—	296	177	133	123	U-MOSIII	30	0.8	0.45			0.5
		SSM5H08TU	20	±12	1.5	—	—	—	220	160	125	U-MOSIII	20	0.5	0.45			0.3
		SSM5H11TU	30	±20	1.6	—	—	—	182	180	U-MOSIII	30	0.7	0.41	0.5			
SSM5H01TU	30	±20	1.4	—	—	—	—	450	106	U-MOSII	20	0.5	0.45	0.3				
SSM5H07TU	20	±20	1.2	—	—	—	—	540	36	π-MOSVII	12	0.5	0.43	0.5				
	P-ch+ SBD	SSM6G18NU	-20	±8	-2.0	261	185	143	112 (@4.5 V)	270	U-MOSVI	30	1.0	0.45	0.5			
	N-ch+ Di	SSM5H14F	30	±12	3.0	—	138	94	78	270	U-MOSIII	45	0.1	0.6	0.1			

* The internal connection diagrams only show the general configurations of the circuits.
Note: For reference only. Land pattern dimensions should be determined empirically.

MOSFET + Tr

Unit: mm

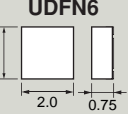
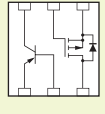
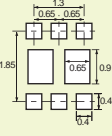
Package	Polarity	Part Number	MOSFET							Tr						*Internal Connections	(Note) Land Pattern Example					
			V _{DSS} (V)	V _{GSS} (V)	I _D (A)	R _{DS(ON)} Max (mΩ)				C _{iss} (pF)	Series	V _{CEO} (V)	I _C (A)	hFE				V _{CE} (sat) (V)				
						V _{GSL} = 1.5 V	V _{GSL} = 1.8 V	V _{GSL} = 2.5 V	V _{GSL} = 4.5 V					Min	Max			V _{CE} (V)	I _C (A)	I _C (A)	I _B (mA)	
	P-ch+ Tr	SSM6Q01NU*	-20	±12	4.0	—	157	76	56	480	U-MOSVI	-20	2	200	500	-2	0.2	0.19	-0.6	-0.02		

*: Under development (All specs are preliminary.)

* The internal connection diagrams only show the general configurations of the circuits.
Note: For reference only. Land pattern dimensions should be determined empirically.

VS-6 Series ... [Part Number: TPC6xxx]

Features

- Low R_{DS(ON)} due to the use of an advanced UMOS process
- Thin package, with a board mounting height as low as 0.85 mm (max)

Product Lineup



Circuit Configuration	Part Number	Absolute Maximum Ratings			R _{DS(ON)} Max (mΩ)						Q _g Typ. (nC)	C _{iss} Typ. (pF)	Marking	Series
		V _{DSS} (V)	V _{GSS} (V)	I _D (A)	V _{GSL} = 10 V	V _{GSL} = 4.5 V	V _{GSL} = 4 V	V _{GSL} = 2.5 V	V _{GSL} = 2.0 V	V _{GSL} = 1.8 V				
N-ch Single	TPC6012	20	±12	6	—	20	—	38	—	—	9	630	S2M	U-MOSIV
	TPC6008-H	30	±20	5.9	60	74	—	—	—	—	4.8	232	S2H	U-MOSVI-H
	TPC6067	30	±20	(6)	(23)	(29)	—	—	—	—	TBD	TBD	S2N	U-MOSVII
	TPC6011	30	±20	6	20	32	—	—	—	—	14	640	S2L	U-MOSIV
	TPC6009-H	40	±20	5.3	81	98	—	—	—	—	4.7	225	S2J	U-MOSVI-H
	TPC6010-H	60	±20	6.1	59	63	—	—	—	—	12	640	S2K	U-MOSVI-H
P-ch Single	TPC6130	-20	±12	-2.8	—	106	—	164	—	—	5.1	360	S3P	U-MOSVI
	TPC6113	-20	±12	-5	—	55	—	85	—	—	10	690	S3N	U-MOSVI
	TPC6111 #	-20	±8	-5.5	—	40	—	57	—	80	10	700	S3L	U-MOSV
	TPC6110	-30	-25/+20	-4.5	56	77	—	—	—	—	14	510	S3K	U-MOSVI
	TPC6109-H #	-30	±20	-5	59	83	—	—	—	—	7.2	471	S3J	U-MOSIII-H

#: With protection Zener diode between gate and source

● VS-8 Series ... [Part Number: TPCF8xxx]

■ Features

- Low on-resistance achieved by employing the U-MOS process
- Thin package, with a board mounting height as low as 0.85 mm (max)
- 32% reduction in mounting area compared with the VS-6 (TSOP-6) Series, due to the use of a high-density flat package
- $P_D = 2.5 \text{ W @ } t = 5 \text{ s}$ when the device is mounted on a glass epoxy board



■ Product Lineup

Circuit Configuration	Part Number	Absolute Maximum Ratings			$R_{DS(ON)}$ Max ($m\Omega$)						Q_g Typ. (nC)	C_{iss} Typ. (pF)	Marking	Series	
		V_{DSS} (V)	V_{GSS} (V)	I_D (A)	$I_{VGS1} = 10 \text{ V}$	$I_{VGS1} = 4.5 \text{ V}$	$I_{VGS1} = 4 \text{ V}$	$I_{VGS1} = 2.5 \text{ V}$	$I_{VGS1} = 2.0 \text{ V}$	$I_{VGS1} = 1.8 \text{ V}$					
N-ch	Single	TPCF8004	30	± 20	7	24	30	—	—	—	—	9	610	F2D	U-MOSVII
	Dual	TPCF8201 #	20	± 12	3	—	49	—	66	100	—	7.5	590	F4A	U-MOSIII
P-ch	Single	TPCF8105	-20	± 12	-6	—	30	—	41	—	100	17	1100	F3E	U-MOSVI
		TPCF8108	-20	± 12	-7	—	26	—	37	—	95	19	1320	F3H	U-MOSVI
		TPCF8107	-30	-25/+20	-6	28	38	—	—	—	—	22	970	F3G	U-MOSVI
	Dual	TPCF8305	-20	± 12	-4	—	58	—	83	160	265	9.2	680	F5E	U-MOSVI
		TPCF8306	-30	-25/+20	-3.2	72	120	—	—	—	—	10	370	F5E	U-MOSVI
		TPCF8304 #	-30	± 20	-3.2	72	105	—	—	—	—	14	600	F5D	U-MOSIV
N-ch + P-ch Complementary	TPCF8402 #	30	± 20	4	50	77	—	—	—	—	10	470	F6B	U-MOSIII	
		-30	± 20	-3.2	72	105	—	—	—	—	14	600	F6B	U-MOSIV	
P-ch + SBD	TPCF8B01 #	-20	± 8	-2.7	—	110	—	160	—	300	6	470	F8A	U-MOSIII	

With protection Zener diode between gate and source

● PS-8 Series ... [Part Number: TPCP8xxx]

■ Features

- Same mounting area as for the VS-6 (TSOP-6) Series
- Flat-leaded package and state-of-the-art process



■ Product Lineup

Circuit Configuration	Part Number	Absolute Maximum Ratings			$R_{DS(ON)}$ Max ($m\Omega$)						Q_g Typ. (nC)	C_{iss} Typ. (pF)	Series	
		V_{DSS} (V)	V_{GSS} (V)	I_D (A)	$I_{VGS1} = 10 \text{ V}$	$I_{VGS1} = 4.5 \text{ V}$	$I_{VGS1} = 4 \text{ V}$	$I_{VGS1} = 2.5 \text{ V}$	$I_{VGS1} = 2.0 \text{ V}$	$I_{VGS1} = 1.8 \text{ V}$				
N-ch	Single	TPCP8006	20	± 12	9.1	—	10	—	13.7	—	—	22	1480	U-MOSIV
		TPCP8004	30	± 20	8.3	8.5	14	—	—	—	—	26	1270	U-MOSIV
		TPCP8007-H	60	± 20	5	57	64	—	—	—	—	5.8	640	U-MOSVI-H
	Dual	TPCP8206	20	± 12	6	—	26	—	35	—	—	5.8	630	U-MOSVII
		TPCP8204	30	± 20	4.2	50	77	—	—	—	—	4.6	190	U-MOSIV
		TPCP8205-H	30	± 20	6.5	26	29	—	—	—	—	14	830	U-MOSVI
P-ch	Single	TPCP8203 #	40	± 20	4.7	40	60	—	—	—	—	16	770	U-MOSIII
		TPCP8105	-20	± 12	-5.2	—	17	—	23	45	60	28	2280	U-MOSVI
	Dual	TPCP8106	-30	-25/+20	-7.2	33	44	—	—	—	—	11.3	870	U-MOSVI
		TPCP8303 #	-20	± 8	-3.8	—	46	—	60	—	90	10	640	U-MOSV
N-ch + P-ch Complementary	Dual	TPCP8306	-20	± 12	-4	—	58	—	83	160	265	9.2	680	U-MOSVI
		TPCP8305	-20	± 12	-6	—	30	—	42	—	—	21.5	1500	U-MOSVI
	Single	TPCP8404	30	± 20	4	50	100	—	—	—	—	4.6	190	U-MOSIV
		TPCP8405	-30	± 20	-4	50	100	—	—	—	—	13	510	U-MOSV
		TPCP8405	30	± 20	6.5	26	29	—	—	—	—	13.8	830	U-MOSVI-H
		TPCP8406	-30	± 20	-6	31.3	42	—	—	—	—	24.1	1075	U-MOSVI
Dual	TPCP8406	40	± 20	6	32	36	—	—	—	—	13.7	850	U-MOSVI-H	
	TPCP8406	-40	± 20	-5	43.2	53.4	—	—	—	—	24.2	1105	U-MOSVI	

With protection Zener diode between gate and source

Product Lineup

Circuit Configuration	Part Number	Absolute Maximum Ratings			R _{DS(ON)} Max (mΩ)						Q _g Typ. (nC)	C _{iss} Typ. (pF)	Series
		V _{DSS} (V)	V _{GSS} (V)	I _D (A)	I _{VGS1} = 10 V	I _{VGS1} = 4.5 V	I _{VGS1} = 4 V	I _{VGS1} = 2.5 V	I _{VGS1} = 2.0 V	I _{VGS1} = 1.8 V			
MOSBD Single	TPCP8BA1 #	-20	±12	-1.3	—	—	180	260	—	—	—	—	U-MOSII
	TPCP8AA1 #	20	±12	1.6	—	—	105	140	—	—	—	—	U-MOSII

#: With protection Zener diode between gate and source

Chip LGA Series ... [Part Number: TPCL4xxx]

Features

- Chip-scale package for high-density board assembly (58% reduction in mounting area compared with the STP2 package)

Product Lineup

Circuit Configuration	Part Number	Absolute Maximum Ratings			R _{DS(ON)} Max (mΩ)						Q _g Typ. (nC)	C _{iss} Typ. (pF)	Series
		V _{DSS} (V)	V _{GSS} (V)	I _D (A)	I _{VGS1} = 10 V	I _{VGS1} = 4.5 V	I _{VGS1} = 4 V	I _{VGS1} = 3.1 V	I _{VGS1} = 2.5 V	I _{VGS1} = 1.8 V			
N-ch Dual	TPCL4201	20	±12	6	—	31	33	44	52	—	11.5	720	U-MOSV
	TPCL4203	24	±12	6	—	36	38	46	55	—	10	685	U-MOSV
	TPCL4202	30	±12	6	—	40	42	50	64	—	10	780	U-MOSV

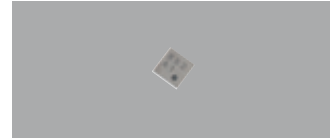

TSON Advance Series ... [Part Number: TPCC8xxx]

Features

- The small thermally enhanced package gives a 64% reduction in mounting area compared with SOP-8, yet an equivalent maximum permissible power dissipation.

Product Lineup

Circuit Configuration	Part Number	Absolute Maximum Ratings			R _{DS(ON)} Max (mΩ)						Q _g Typ. (nC)	C _{iss} Typ. (pF)	Series
		V _{DSS} (V)	V _{GSS} (V)	I _D (A)	I _{VGS1} = 10 V	I _{VGS1} = 4.5 V	I _{VGS1} = 4 V	I _{VGS1} = 2.5 V	I _{VGS1} = 2.0 V	I _{VGS1} = 1.8 V			
N-ch Single	TPCC8093	20	±12	21	—	5.8	—	9.5	—	—	16	1860	U-MOSVII
	TPCC8061-H	30	±20	8	26	29	—	—	—	—	6.2	630	U-MOSVII-H
	TPCC8067-H	30	±20	9	25	33	—	—	—	—	4.7	690	U-MOSVII-H
	TPCC8066-H	30	±20	11	11	19	—	—	—	—	7.6	1100	U-MOSVII-H
	TPCC8068-H	30	±20	13	11.6	16	—	—	—	—	14	980	U-MOSVII-H
	TPCC8065-H	30	±20	13	11.4	14.5	—	—	—	—	9.9	1350	U-MOSVII-H
	TPCC8064-H	30	±20	19	8.2	10.6	—	—	—	—	11	1600	U-MOSVII-H
	TPCC8062-H	30	±20	27	5.6	7.1	—	—	—	—	17	2400	U-MOSVII-H
	TPCC8074	30	±20	20	6.3	8.5	—	—	—	—	25	1800	U-MOSVII
	TPCC8073	30	±20	27	4.5	5.9	—	—	—	—	37	2600	U-MOSVII
	TPN2R503NC	30	±20	(40)	(2.5)	(4.1)	—	—	—	—	(40)	(2230)	U-MOSVIII
	SIDP1	30	±20	TBD	(6.3)	TBD	—	—	—	—	TBD	TBD	U-MOSVIII
	SICA7	30	±20	TBD	(4.3)	TBD	—	—	—	—	TBD	TBD	U-MOSVIII
	P-ch Single	TPCC8084 #	33	±20	21	6.7	9.0	—	—	—	—	27	1900
TPCC8076 #		33	±20	27	4.6	6.2	—	—	—	—	34	2500	U-MOSVII
TPCC8136		-20	±12	-9.4	—	16	—	21	27	60	36	2350	U-MOSVI
TPCC8137		-20	±12	-13	—	10	16	30	52	—	43	2990	U-MOSVIII
TPCC8138		-20	±12	-18	—	7.5	11	21	42	—	63	4165	U-MOSVIII
TPCC8131		-30	±20	-10	17.6	23	—	—	—	—	40	1700	U-MOSVI
TPCC8103		-30	±20	-18	12	—	25	—	—	—	38	1600	U-MOSV
TPCC8104		-30	-25/+20	-20	8.8	12.4	—	—	—	—	58	2260	U-MOSVI
TPCC8105		-30	-25/+20	-23	7.8	10.4	—	—	—	—	76	3240	U-MOSVI

#: With protection Zener diode between gate and source

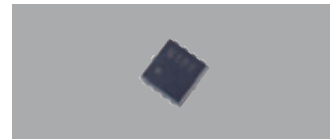

● SOP-8 Series ... [Part Number: TPC8xxx]

■ Features

- Low on-resistance and high-speed-switching series are available.
- On-resistance reduction through the use of an Al strap structure

■ Product Lineup



Circuit Configuration	Part Number	Absolute Maximum Ratings			$R_{DS(ON)}$ Max (m Ω)						Q_g Typ. (nC)	C_{iss} Typ. (pF)	Series	
		V_{DSS} (V)	V_{GSS} (V)	I_D (A)	$I_{VGS1} = 10$ V	$I_{VGS1} = 4.5$ V	$I_{VGS1} = 4$ V	$I_{VGS1} = 2.5$ V	$I_{VGS1} = 2.0$ V	$I_{VGS1} = 1.8$ V				
N-ch	Single	TPC8067-H	30	± 20	9	25	33	—	—	—	—	4.7	690	U-MOSVII-H
		TPC8066-H	30	± 20	11	16	19	—	—	—	—	7.6	1100	U-MOSVII-H
		TPC8065-H	30	± 20	13	11.6	14.7	—	—	—	—	9.9	1350	U-MOSVII-H
		TPC8064-H	30	± 20	16	8.4	10.8	—	—	—	—	11	1600	U-MOSVII-H
		TPC8063-H	30	± 20	17	7.0	8.9	—	—	—	—	13	1900	U-MOSVII-H
		TPC8062-H	30	± 20	18	5.8	7.3	—	—	—	—	17	2400	U-MOSVII-H
		TPC8059-H	30	± 20	18	4.0	5.0	—	—	—	—	21	2900	U-MOSVII-H
		TPC8058-H	30	± 20	18	3.2	4.0	—	—	—	—	26	3600	U-MOSVII-H
		TPC8057-H	30	± 20	18	2.8	3.4	—	—	—	—	31	4300	U-MOSVII-H
		TPC8056-H	30	± 20	18	2.4	2.9	—	—	—	—	38	5200	U-MOSVII-H
		TPC8055-H	30	± 20	18	2.1	2.5	—	—	—	—	47	6400	U-MOSVII-H
		TPC8092	30	± 20	15	9.0	11.1	—	—	—	—	25	1800	U-MOSVII
		TPC8074	30	± 20	17	6.5	8.7	—	—	—	—	25	1800	U-MOSVII
		TPC8086 #	30	± 20	17	6.4	8.5	—	—	—	—	26	1900	U-MOSVII
		TPC8073	30	± 20	18	4.7	6.1	—	—	—	—	37	2600	U-MOSVII
		TPC8085 #	30	± 20	18	4.7	6.1	—	—	—	—	37	2600	U-MOSVII
		TPC8082	30	± 20	18	4	5	—	—	—	—	41	2900	U-MOSVII
		TPC8081	30	± 20	18	3.2	4	—	—	—	—	51	3600	U-MOSVII
		TPC8080	30	± 20	18	2.8	3.4	—	—	—	—	61	4300	U-MOSVII
		TPC8088	30	± 20	18	2.4	2.9	—	—	—	—	74	5200	U-MOSVII
	TPC8087	30	± 20	18	2.1	2.5	—	—	—	—	91	6400	U-MOSVII	
	TPC8084 #	33	± 20	17	6.9	9.2	—	—	—	—	27	1900	U-MOSVII	
	TPC8076 #	33	± 20	18	4.9	6.5	—	—	—	—	34	2500	U-MOSVII	
	TPC8075	33	± 20	18	2.6	3.3	—	—	—	—	70	5200	U-MOSVII	
	TPC8078	33	± 20	18	2.2	2.8	—	—	—	—	90	6400	U-MOSVII	
	TPC8052-H	40	± 20	12	11.5	13.3	—	—	—	—	13	1620	U-MOSVI-H	
	TPC8047-H	40	± 20	16	7.6	8.8	—	—	—	—	23	2590	U-MOSVI-H	
	TPC8046-H	40	± 20	18	5.7	6.6	—	—	—	—	31	3545	U-MOSVI-H	
	TPC8045-H	40	± 20	18	3.9	4.4	—	—	—	—	48	5800	U-MOSVI-H	
	TPC8053-H	60	± 20	9	22.5	24.2	—	—	—	—	13	1620	U-MOSVI-H	
	TPC8050-H	60	± 20	11	14.5	15.6	—	—	—	—	21	2590	U-MOSVI-H	
	TPC8049-H	60	± 20	13	10.7	11.5	—	—	—	—	29	3545	U-MOSVI-H	
	TPC8048-H	60	± 20	16	6.9	7.4	—	—	—	—	46	5800	U-MOSVI-H	
TPC8051-H	80	± 20	13	9.7	10.1	—	—	—	—	43	5800	U-MOSVI-H		
Dual	TPC8224-H	30	± 20	8	26	34	—	—	—	—	4.7	690	U-MOSVII-H	
	TPC8223-H	30	± 20	9	17	21	—	—	—	—	8.3	1100	U-MOSVII-H	
	TPC8227-H	40	± 20	TBD	(33)	(40)	—	—	—	—	TBD	640	U-MOSVI-H	
	TPC8228-H	60	± 20	TBD	(57)	(64)	—	—	—	—	TBD	640	U-MOSVI-H	
TPC8229-H	80	± 20	TBD	(80)	(87)	—	—	—	—	TBD	640	U-MOSVI-H		
P-ch	Single	TPC8129	-30	-25/+20	-9	22	28	—	—	—	—	39	1650	U-MOSVI
		TPC8125	-30	-25/+20	-10	13	17	—	—	—	—	64	2580	U-MOSVI
		TPC8126	-30	-25/+20	-11	10	14	—	—	—	—	56	2400	U-MOSVI
		TPC8123	-30	-25/+20	-11	9	12.5	—	—	—	—	68	2940	U-MOSVI
		TPC8127	-30	-25/+20	-13	6.5	8.9	—	—	—	—	92	3800	U-MOSVI
		TPC8128	-30	-25/+20	-16	5	6.9	—	—	—	—	115	4800	U-MOSVI
		TPC8120	-30	-25/+20	-18	3.2	4.2	—	—	—	—	180	7420	U-MOSVI
		TPC8134	-40	-25/+20	-5	52	66	—	—	—	—	20	890	U-MOSVI
		TPC8132	-40	-25/+20	-7	25	33	—	—	—	—	34	1580	U-MOSVI
		TPC8133	-40	-25/+20	-9	15	18	—	—	—	—	64	2900	U-MOSVI
TPC8124	-40	-25/+20	-12	8	10	—	—	—	—	104	4750	U-MOSVI		
N-ch + P-ch Complementary		TPC8407	30	± 20	9	17	21	—	—	—	—	17	1190	U-MOSVII-H
			-30	± 20	-7.4	23	29	—	—	—	—	39	1650	U-MOSVI
		TPC8408	40	± 20	6.1	32	36	—	—	—	—	14	850	U-MOSVI-H
			-40	± 20	-5.3	43	53	—	—	—	—	24	1105	U-MOSVI

With protection Zener diode between gate and source

● SOP Advance Series ... [Part Number: TPCA8xxx, TPHxxx]

■ Features

- Low on-resistance and high-speed-switching series are available.
- High-current, thin and thermally enhanced package

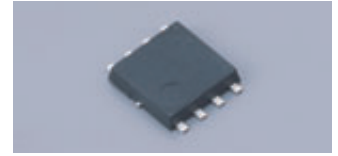

■ Product Lineup

Circuit Configuration	Part Number	Absolute Maximum Ratings			R _{DS(ON)} Max (mΩ)							Q _g Typ. (nC)	C _{iss} Typ. (pF)	Series	
		V _{DSS} (V)	V _{GSS} (V)	I _D (A)	I _{VGS1} = 10 V	I _{VGS1} = 6 V	I _{VGS1} = 4.5 V	I _{VGS1} = 4 V	I _{VGS1} = 2.5 V	I _{VGS1} = 2.0 V	I _{VGS1} = 1.8 V				
N-ch	Single	TPCA8011-H #	20	±12	40	—	—	3.5	—	7.5	—	—	32	290	U-MOSIII-H
		TPCA8082	30	±20	32	3.8	—	4.8	—	—	—	—	41	2900	U-MOSVII
		TPCA8081	30	±20	38	3	—	3.8	—	—	—	—	51	3600	U-MOSVII
		TPCA8080	30	±20	42	2.6	—	3.2	—	—	—	—	61	4300	U-MOSVII
		TPCA8088	30	±20	48	2.2	—	2.7	—	—	—	—	74	5200	U-MOSVII
		TPCA8087	30	±20	56	1.9	—	2.3	—	—	—	—	91	6400	U-MOSVII
		TPCA8068-H	30	±20	15	11.6	—	16	—	—	—	—	7.2	980	U-MOSVII-H
		TPCA8065-H	30	±20	16	11.4	—	14.5	—	—	—	—	9.9	1350	U-MOSVII-H
		TPCA8064-H	30	±20	20	8.2	—	10.6	—	—	—	—	11	1600	U-MOSVII-H
		TPCA8063-H	30	±20	22	6.8	—	8.7	—	—	—	—	13	1900	U-MOSVII-H
		TPCA8062-H	30	±20	28	5.6	—	7.1	—	—	—	—	17	2400	U-MOSVII-H
		TPCA8059-H	30	±20	32	3.8	—	4.8	—	—	—	—	21	2900	U-MOSVII-H
		TPCA8058-H	30	±20	38	3.0	—	3.8	—	—	—	—	26	3600	U-MOSVII-H
		TPCA8057-H	30	±20	42	2.6	—	3.2	—	—	—	—	31	4300	U-MOSVII-H
		TPCA8056-H	30	±20	48	2.2	—	2.7	—	—	—	—	38	5200	U-MOSVII-H
		TPCA8055-H	30	±20	56	1.9	—	2.3	—	—	—	—	47	6400	U-MOSVII-H
		TPCA8075	33	±20	48	2.4	—	3.1	—	—	—	—	70	5200	U-MOSVII
		TPCA8078	33	±20	54	2.1	—	2.6	—	—	—	—	90	6400	U-MOSVII
		TPCA8052-H	40	±20	20	11.3	—	13.1	—	—	—	—	13	1620	U-MOSVI-H
		TPCA8047-H	40	±20	32	7.3	—	8.5	—	—	—	—	23	2590	U-MOSVI-H
		TPCA8046-H	40	±20	38	5.4	—	6.3	—	—	—	—	29	3545	U-MOSVI-H
		TPCA8045-H	40	±20	46	3.6	—	4.1	—	—	—	—	47	5800	U-MOSVI-H
		TPH14006NH	60	±20	(14)	(14)	(19)	—	—	—	—	—	(16)	(1020)	U-MOSVIII-H
		TPCA8053-H	60	±20	15	22.3	—	24	—	—	—	—	13	1620	U-MOSVI-H
		TPH7R506NH	60	±20	(22)	(7.5)	(3.3)	—	—	—	—	—	(31)	(1785)	U-MOSVIII-H
		TPCA8050-H	60	±20	24	14.2	—	15.3	—	—	—	—	21	2590	U-MOSVI-H
		TPCA8049-H	60	±20	28	10.4	—	11.2	—	—	—	—	29	3545	U-MOSVI-H
		TPH5R906NH	60	±20	(28)	(5.9)	(14)	—	—	—	—	—	(38)	(3100)	U-MOSVIII-H
TPH4R606NH	60	±20	(32)	(4.6)	(11)	—	—	—	—	—	(49)	(3050)	U-MOSVIII-H		
TPCA8048-H	60	±20	35	6.6	—	7.1	—	—	—	—	46	5800	U-MOSVI-H		
TPCA8051-H	80	±20	28	9.4	—	9.8	—	—	—	—	47	5800	U-MOSVI-H		
P-ch	Single	TPCA8131	-30	-25/+20	-13	17	—	22	—	—	—	40	1700	U-MOSVII	
		TPCA8109	-30	-25/+20	-24	9	—	13	—	—	—	56	2400	U-MOSVI	
		TPCA8128	-30	-25/+20	-40	4.8	—	6.7	—	—	—	115	4800	U-MOSVI	
		TPCA8106	-30	±20	-40	3.7	—	—	—	—	—	130	4600	U-MOSV	
		TPCA8120	-30	-25/+20	-45	3	—	4	—	—	—	190	7420	U-MOSVI	
MOSBD	Single	TPCA8A11-H	30	±20	35	3.6	—	4.6	—	—	—	23	3200	U-MOSVII-H	
		TPCA8A10-H	30	±20	40	3.0	—	3.8	—	—	—	29	4000	U-MOSVII-H	
		TPCA8A09-H	30	±20	51	2.3	—	2.8	—	—	—	41	5960	U-MOSVII-H	

#. With protection Zener diode between gate and source

● DPAK Series ... [Part Number: TxxxPxxxM1]

■ Features

- High-current, thermally enhanced package

■ Product Lineup

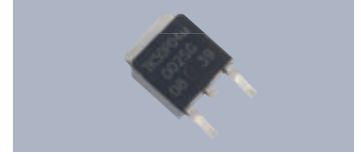

Circuit Configuration	Part Number	Absolute Maximum Ratings			$R_{DS(ON)}$ Max ($m\Omega$)						Q_g Typ. (nC)	C_{iss} Typ. (pF)	Series	
		V_{DSS} (V)	V_{GSS} (V)	I_D (A)	$I_{VGS1} = 10\text{ V}$	$I_{VGS1} = 4.5\text{ V}$	$I_{VGS1} = 4\text{ V}$	$I_{VGS1} = 2.5\text{ V}$	$I_{VGS1} = 2.0\text{ V}$	$I_{VGS1} = 1.8\text{ V}$				
N-ch	Single	TK40P03M1	30	± 20	40	10.8	14.4	—	—	—	—	9.4	1150	U-MOSVI-H
		TK45P03M1	30	± 20	45	9.7	12	—	—	—	—	13	1500	U-MOSVI-H
		TK50P03M1	30	± 20	50	7.5	9.8	—	—	—	—	13.3	1700	U-MOSVI-H
		TK60P03M1	30	± 20	60	6.4	7.8	—	—	—	—	21	2700	U-MOSVI-H
		TK20P04M1	40	± 20	20	29	34	—	—	—	—	7.6	985	U-MOSVI-H
		TK40P04M1	40	± 20	40	11	13.4	—	—	—	—	15	1920	U-MOSVI-H
		TK50P04M1	40	± 20	50	8.7	10.2	—	—	—	—	20	2600	U-MOSVI-H
P-ch	Single	TJ15P04M3	-40	± 20	-15	36	48	—	—	—	—	26	1100	U-MOSVI

4-7 Standard MOSFET Series ($I_D < 500 \text{ mA}$)

Single MOSFETs

Polarity	Absolute Maximum Ratings			$R_{DS(ON)}$ Typ. (Max) (Ω)	V_{GS} (V)	Package					
	V_{DSS} (V)	V_{GSS} (V)	I_D (mA)			S-Mini (SOT-346) 2925 size, 3-pin	USM (SOT-323) 2021 size, 3-pin	UFM 2021 size, 3-pin	SSM (SOT-416) 1616 size, 3-pin	VESM (SOT-723) 1212 size, 3-pin	CST3 1006 size, 3-pin
N-ch	20	± 10	180	5 (20)	1.2	—	—	—	SSM3K35FS	SSM3K35MFV	SSM3K35CT
	20	± 10	200	3.07(5.6)	1.5	—	—	—	SSM3K37FS	—	SSM3K37CT
	20	± 10	250	3.07(5.6)	1.5	—	—	—	—	SSM3K37MFV	—
	20	± 10	500	0.95 (1.52)	1.5	—	—	SSM3K36TU	SSM3K36FS	SSM3K36MFV	—
	30	± 20	100	4.0 (7.0)	2.5	SSM3K15F	—	—	—	—	—
	30	± 20	100	3.5 (6.0)	2.5	—	SSM3K15AFU	—	SSM3K15AFS	SSM3K15AMFV	SSM3K15ACT
	30	± 20	100	4.0 (7.0)	2.5	—	—	—	SSM3K44FS#	SSM3K44MFV#	—
	30	± 20	400	0.8 (1.2)	4.0	—	SSM3K09FU	—	—	—	—
	50	± 7	100	22 (40)	2.5	—	SSM3K17FU	—	—	—	—
P-ch	60	± 20	200	2.1 (3.3)	4.5	SSM3K7002BF	SSM3K7002BFU	—	SSM3K7002BFS	—	—
	-20	± 10	-100	11 (44)	-1.2	—	—	—	SSM3J35FS	SSM3J35MFV	SSM3J35CT
	-20	± 8	-330	2.23 (3.6)	-1.5	—	—	SSM3J36TU	SSM3J36FS	SSM3J36MFV	—
	-30	± 20	-100	14 (32)	-2.5	SSM3J15F	SSM3J15FU	—	SSM3J15FS	SSM3J15FV	SSM3J15CT
	-30	± 20	-200	3.3 (4.2)	-4.0	—	SSM3J09FU	—	—	—	—
	-60	± 20	-200	1.3 (2.0)	-10	2SJ168	—	—	—	—	—

#: High ESD protection

Dual MOSFETs

Polarity	Absolute Maximum Ratings			$R_{DS(ON)}$ Typ. (Max) (Ω)	V_{GS} (V)	Package						Constituent Devices
	V_{DSS} (V)	V_{GSS} (V)	I_D (mA)			US6 (SOT-363) 2021 size, 6-pin	UF6 2021 size, 6-pin	USV (SOT-353) 2021 size, 5-pin	ES6 (SOT-563) 1616 size, 6-pin	ESV (SOT-553) 1616 size, 5-pin	CST6D 1009 size, 6-pin	
N-chx2	20	± 10	180	5 (20)	1.2	SSM6N35FU	—	—	SSM6N35FE	—	—	SSM3K35FSx2
	20	± 10	100	5.2 (15)	1.5	—	—	SSM5N16FU	—	SSM5N16FE	—	SSM3K16FUx2
	20	± 10	250	3.07 (5.6)	1.5	—	SSM6N37FU	—	SSM6N37FE	—	SSM6N37CTD	SSM3K37MFVx2
	20	± 10	500	0.95 (1.52)	1.5	—	SSM6N36TU	—	SSM6N36FE	—	—	SSM3K36FSx2
	30	± 20	100	3.5 (6.0)	2.5	SSM6N15AFU	—	—	SSM6N15AFE	—	—	SSM3K15AFUx2
	30	± 20	100	4.0 (7.0)	2.5	SSM6N44FU#	—	—	SSM6N44FE#	—	—	SSM3K44FSx2
	30	± 20	100	4.0 (7.0)	2.5	—	—	SSM5N15FU	—	SSM5N15FE	—	SSM3K15FUx2
	30	± 20	400	0.8 (1.2)	4.0	SSM6N09FU	—	—	—	—	—	SSM3K09FUx2
	50	± 7	100	22 (40)	2.5	SSM6N17FU	—	—	—	—	—	SSM3K17FUx2
P-chx2	60	± 20	200	2.1 (3.3)	4.5	SSM6N7002BFU	—	—	SSM6N7002BFE	—	—	SSM3K7002BFUx2
	-20	± 10	-100	11 (44)	-1.2	SSM6P35FU	—	—	SSM6P35FE	—	—	SSM3J35FSx2
	-20	± 10	-100	18 (45)	-1.5	SSM6P16FU	—	SSM5P16FU	SSM6P16FE	SSM5P16FE	—	SSM3J16FUx2
	-20	± 8	-330	2.23 (3.6)	-1.5	—	SSM6P36TU	—	SSM6P36FE	—	—	SSM3J36FSx2
	-30	± 20	-100	14 (32)	-2.5	SSM6P15FU	—	SSM5P15FU	SSM6P15FE	SSM5P15FE	—	SSM3J15FUx2
N-ch+ P-ch	-30	± 20	-200	3.3 (4.2)	-4.0	SSM6P09FU	—	—	—	—	—	SSM3J09FUx2
	20	± 10	180	5 (20)	1.2	SSM6L35FU	—	—	SSM6L35FE	—	—	SSM3K35FS
	-20	± 10	-100	11 (44)	-1.2	—	—	—	—	—	—	+SSM3J35FS
	20	± 10	500	0.95 (1.52)	1.5	—	SSM6L36TU	—	SSM6L36FE	—	—	SSM3K36FS
	-20	± 8	-330	2.23 (3.6)	-1.5	—	—	—	—	—	—	+SSM3J36FS
	30	± 20	400	0.8 (1.2)	4.0	—	—	—	—	—	—	SSM3K09FU
	-30	± 20	-200	3.3 (4.2)	-4.0	SSM6L09FU	—	—	—	—	—	+SSM3J09FU

#: High ESD protection

5-1 DPAK+ Series for Automotive Applications

The DPAK+ Series, which uses Cu connectors, realizes high current-carrying capability and low on-resistance equivalent to the conventional D2PAK.

■ Features

- Achieves low on-resistance, low package inductance and low thermal resistance due to the use of Cu connectors.
- AEC-Q-101-qualified at a channel temperature (T_{ch}) of 175°C

$I_D = 10$ to 80 A class

[Low on-resistance] (TK80S04K3L)

$R_{DS(ON)} = 2.4 \text{ m}\Omega$ (typ.) $C_{iss} = 4340 \text{ pF}$ (typ.)

[High current and high power dissipation]

$I_{D(DC)} = 80 \text{ A}$, $P_D = 100 \text{ W}$ (TK80S04K3L)

[Temperature cycling test]

-55°C to 150°C , 1000 cycles



■ Product Lineup

Part Number	Absolute Maximum Ratings			$R_{DS(ON)}$ Max (m Ω)		C_{iss} Typ. (pF)	Q_g Typ. (nC)	T_{ch} ($^\circ\text{C}$)	Series
	V_{DS} (V)	V_{GS} (V)	I_D (A)	$I_{VGS1} = 10 \text{ V}$	$I_{VGS1} = 6 \text{ V}$				
TK80S04K3L	40	± 20	80	3.1	4.8	4340	87	175	U-MOSIV
TK65S04K3L		± 20	65	4.5	7.9	2800	63	175	U-MOSIV
TK50S04K3L		± 20	50	5.4	10	2010	42	175	U-MOSIV
TK35S04K3L		± 20	35	10.3	15	1370	28	175	U-MOSIV
TK20S04K3L		± 20	20	14	26	820	18	175	U-MOSIV
TK10S04K3L		± 20	10	28	54	410	10	175	U-MOSIV
TK80S06K3L	60	± 20	80	5.5	7.8	4200	85	175	U-MOSIV
TK60S06K3L		± 20	60	8	12.3	2900	60	175	U-MOSIV
TK45S06K3L		± 20	45	10.5	16.4	1950	41	175	U-MOSIV
TK30S06K3L		± 20	30	18	30	1350	28	175	U-MOSIV
TK20S06K3L		± 20	20	29	40	780	18	175	U-MOSIV
TK8S06K3L		± 20	8	54	80	400	10	175	U-MOSIV
TK40S10K3Z	100	± 20	40	18	—	3110	61	175	U-MOSIV
TJ80S04M3L	-40	-20/10	-80	5.2	7.9	7770	158	175	U-MOSVI
TJ60S04M3L		-20/10	-60	6.3	9.4	6510	125	175	U-MOSVI
TJ40S04M3L		-20/10	-40	9.1	13	4140	83	175	U-MOSVI
TJ20S04M3L		-20/10	-20	22.2	32	1850	37	175	U-MOSVI
TJ10S04M3L		-20/10	-10	44	62	930	19	175	U-MOSVI
TJ60S06M3L		-20/10	-60	11.2	14.5	7760	156	175	U-MOSVI
TJ50S06M3L	-60	-20/10	-50	13.8	17.4	6290	124	175	U-MOSVI
TJ30S06M3L		-20/10	-30	21.8	28	3950	80	175	U-MOSVI
TJ15S06M3L		-20/10	-15	50	63	1770	36	175	U-MOSVI
TJ8S06M3L		-20/10	-8	104	130	890	19	175	U-MOSVI

5-2 U-MOS (Trench Type) Series for Automotive Applications

Fabricated using a trench structure, the U-MOS Series realizes ultra-high integration density and thus ultra-low on-resistance.

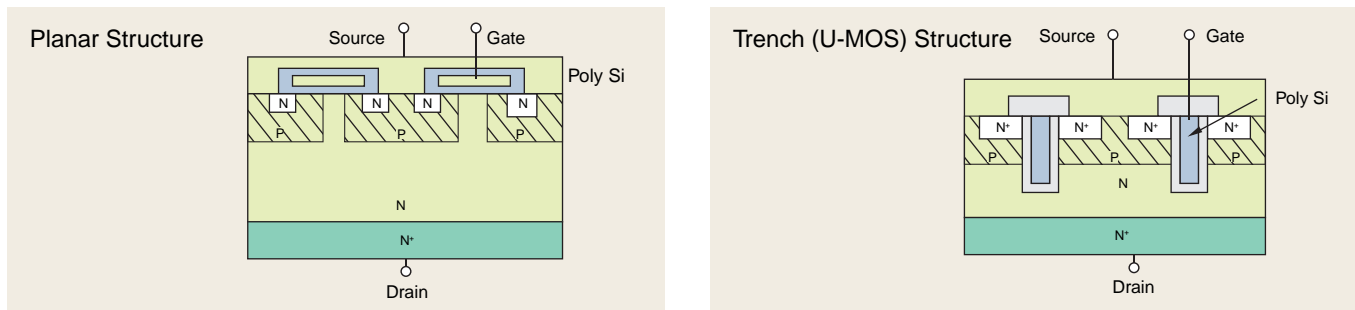

■ Features

- High density through the use of submicron technology
- 60% reduction in $R_{DS(ON)}$ by per unit area (as compared with the maximum $R_{DS(ON)}$ of L^2 - π -MOSV)
- Guaranteed avalanche capability and improved di/dt rate
- AEC-Q101-qualified at a channel temperature (T_{ch}) of 175°C, except some devices (See the "Tch" column in the following table.)

■ Product Lineup

Applications	Part Number	Absolute Maximum Ratings				Package	$R_{DS(ON)}$ Max (m Ω)				Q_9 Typ. (nC)	T_{ch} (°C)	Series
		V_{DSS} (V)	V_{GSS} (V)	I_b (A)	P_b (W)		$I_{VGS1} = 10$ V	$I_{VGS1} = 6$ V	$I_{VGS1} = 4.5$ V	$I_{VGS1} = 4$ V			
Motor drive Solenoids Lamp drivers DC-DC converters	TJ100F04M3L #	-40	-20/+10	-100	250	TO-220SM(W)	3.6	5.4	—	—	250	175	U-MOSVI
	TJ150F04M3L #	-40	-20/+10	-150	300	TO-220SM(W)	2.8	4.2	—	—	370	175	
	TJ70A06J3 #	-60	± 20	-70	54	TO-220SIS	8.0	—	10	—	246	175	U-MOSIII
	TJ100F06M3L	-60	-20/+10	-100	250	TO-220SM(W)	7.1	10.7	—	—	250	175	
	TJ150F06M3L #	-60	-20/+10	-150	300	TO-220SM(W)	5.6	6.1	—	—	420	175	
LCD backlight inverter	TJ9A10M3	-100	± 20	-9	19	TO-220SIS	170	—	—	—	47	150	U-MOSVI
	TJ11A10M3	-100	± 20	-11	24	TO-220SIS	130	—	—	—	76	150	
	TJ20A10M3	-100	± 20	-20	35	TO-220SIS	90	—	—	—	120	150	
Motor drive Solenoids Lamp drivers DC-DC converters	TK50A04K3 #	40	± 20	50	42	TO-220SIS	3.5	—	—	—	102	175	
	TK80F04K3L	40	± 20	80	125	TO-220SM(W)	4.5	5.7	—	—	75	175	
	TK100F04K3	40	± 20	100	200	TO-220SM(W)	3.0	—	—	—	102	175	
	TK100F04K3L #	40	± 20	100	200	TO-220SM(W)	3.0	4.5	—	—	105	175	
	TK150F04K3	40	± 20	150	300	TO-220SM(W)	2.1	—	—	—	166	175	
	TK150F04K3L #	40	± 20	150	300	TO-220SM(W)	2.1	3.2	—	—	190	175	
	TK80F06K3L	60	± 20	80	125	TO-220SM(W)	7.8	9.3	—	—	74	175	
	TK100F06K3	60	± 20	100	180	TO-220SM(W)	5.0	—	—	—	98	175	U-MOSIV
	TK130F06K3	60	± 20	130	300	TO-220SM(W)	3.4	—	—	—	170	175	
	TK55F08K3L	75	± 20	55	125	TO-220SM(W)	10.2	12	—	—	67	175	
	TK60F08K3	75	± 20	60	150	TO-220SM(W)	8.5	—	—	—	75	175	
TK80F08K3	75	± 20	80	300	TO-220SM(W)	4.3	—	—	—	175	175		
LCD backlight inverter	TK8A10K3	100	± 20	8	18	TO-220SIS	120	—	—	—	12.9	150	
	TK12A10K3	100	± 20	12	20	TO-220SIS	80	—	—	—	18	150	
	TK25A10K3	100	± 20	25	25	TO-220SIS	40	—	—	—	34	150	

#: With protection Zener diode between gate and source

Note: If you want to use any devices listed above for "Unintended Use" including automotive applications, contact your local Toshiba sales representative.

5-3 U-MOS Series for Synchronous Rectification ($V_{DS} = 60\text{ V to }150\text{ V}$)

■ Features

- Low on-resistance achieved by high density through the use of submicron technology
- Guaranteed avalanche capability

■ Comparisons Between Synchronous Rectification MOSFETs

Characteristic	Symbol	Test Conditions	TK65E10N1 U-MOSVIII-H			TK40E10K3 U-MOSIV			Unit
			Min	Typ.	Max	Min	Typ.	Max	
Gate Leakage Current	+I _{GSS}	V _{GS} = 20 V, V _{DS} = 0 V	—	—	0.1	—	—	1	μA
	-I _{GSS}	V _{GS} = -20 V, V _{DS} = 0 V	—	—	-0.1	—	—	-1	μA
Drain Cut-off Current	I _{DSS}	V _{DS} = 100 V, V _{GS} = 0 V	—	—	10	—	—	10	μA
Drain-source Breakdown Voltage	V _{(BR) DSS}	I _D = 10 mA, V _{GS} = 0 V	100	—	—	100	—	—	V
Gate Threshold Voltage	V _{th}	V _{DS} = 10 V, I _D = 1 mA	2.0	—	4.0	2.0	—	4.0	V
		V _{GS} = 10 V, I _D = 32.5 A	—	4.0	4.8	—	—	—	mΩ
Drain-source On-resistance	R _{DS(on)}	V _{GS} = 10 V, I _D = 20 A	—	—	—	—	12	15	mΩ
		V _{GS} = 10 V, V _{DS} = 0 V	—	5900	—	—	4000	—	pF
Input Capacitance	C _{iss}	V _{DS} = 10 V, V _{GS} = 0 V f = 1 MHz	—	430	—	—	330	—	pF
Reverse Transfer Capacitance	C _{rss}		—	2900	—	—	460	—	pF
Output Capacitance	C _{oss}		—	—	—	—	—	—	V
Forward Voltage	V _{DSF}	I _{DR} = 65 A, V _{GS} = 0 V	—	—	-1.2	—	—	—	V
		I _{DR} = 40 A, V _{GS} = 0 V	—	—	—	—	—	-1.2	V

■ Efficiency Test Circuit

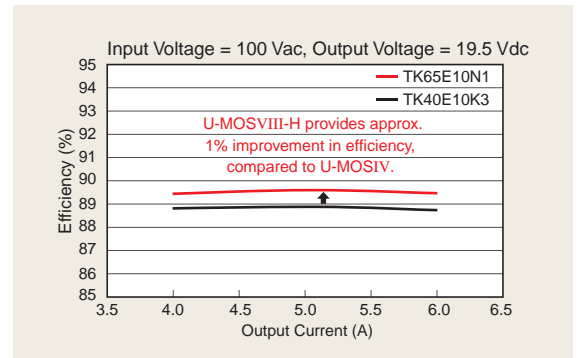
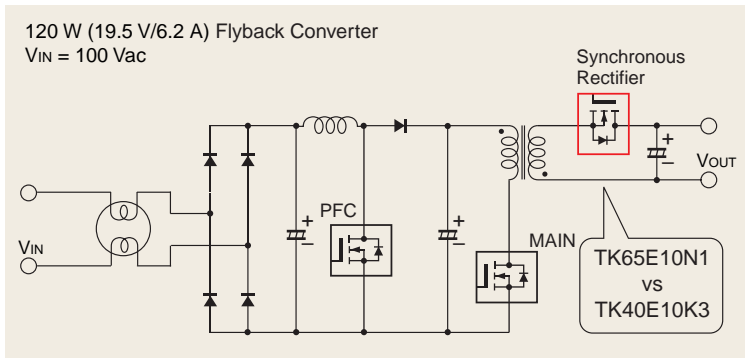

■ Product Lineup

Part Number	Absolute Maximum Ratings				R _{DS(on)} (mΩ) @ V _{GS} = 10 V		Q _g (nC) Typ. V _{DD} = V _{DS} x 0.8, I _D = I _{D(FC)}	Q _{sw} (nC) Typ.	Package	Series
	V _{DS} (V)	V _{GSS} (V)	I _D (A)	P _D (W)	Typ.	Max				
TK25E06K3	60	±20	25	60	14	18	29	—	TO-220	U-MOSIV
TK50E06K3A	60	±20	50	104	6.8	8.5	54	—	TO-220	U-MOSIV
TK75A06K3	60	±20	75	35	4.5	5.5	85	—	TO-220SIS	U-MOSIV
TK80E06K3A	60	±20	80	125	4.8	5.8	90	—	TO-220	U-MOSIV
TK40A08K3	75	±20	40	42	7	9	80	—	TO-220SIS	U-MOSIV
TK50E08K3	75	±20	50	104	9.5	12	55	—	TO-220	U-MOSIV
TK60E08K3	75	±20	60	128	7.5	9	75	—	TO-220	U-MOSIV
TK80A08K3	75	±20	80	40	3.6	4.5	175	80	TO-220SIS	U-MOSIV
TK46E08N1 *	80	±20	46	103	(7)	(8.6)	TBD	TBD	TO-220	U-MOSVIII-H
TK46A08N1 *	80	±20	46	35	(7)	(8.6)	TBD	TBD	TO-220SIS	U-MOSVIII-H
TK72E08N1 *	80	±20	72	192	(3.6)	(4.4)	TBD	TBD	TO-220	U-MOSVIII-H
TK72A08N1 *	80	±20	72	45	(3.8)	(4.7)	TBD	TBD	TO-220SIS	U-MOSVIII-H
TK100E08N1	80	±20	100	255	2.6	3.2	130	53	TO-220	U-MOSVIII-H
TK100A08N1	80	±20	100	45	2.6	3.2	130	53	TO-220SIS	U-MOSVIII-H
TK100G08N1 *	80	±20	100	TBD	(2.4)	(3)	TBD	TBD	TO-220SM	U-MOSVIII-H
TK18E10K3	100	±20	18	71	33	42	33	—	TO-220	U-MOSIV
TK22E10N1	100	±20	22	72	11.5	13.8	28	12	TO-220	U-MOSVIII-H
TK22A10N1	100	±20	22	30	11.5	13.8	28	12	TO-220SIS	U-MOSVIII-H
TK34E10N1	100	±20	34	103	7.9	9.5	38	15	TO-220	U-MOSVIII-H
TK34A10N1	100	±20	34	35	7.9	9.5	38	15	TO-220SIS	U-MOSVIII-H
TK40E10K3	100	±20	40	147	12	15	84	—	TO-220	U-MOSIV
TK40A10K3	100	±20	40	40	11.5	15	85	40	TO-220SIS	U-MOSIV
TK40E10N1	100	±20	40	126	6.8	8.2	49	21	TO-220	U-MOSVIII-H
TK40A10N1	100	±20	40	35	6.8	8.2	49	21	TO-220SIS	U-MOSVIII-H
TK65E10N1	100	±20	65	192	4	4.8	81	32	TO-220	U-MOSVIII-H
TK65A10N1	100	±20	65	45	4	4.8	81	32	TO-220SIS	U-MOSVIII-H
TK65G10N1 *	100	±20	65	192	3.8	4.6	81	32	TO-220SM	U-MOSVIII-H
TK100E10N1	100	±20	100	255	2.8	3.4	140	55	TO-220	U-MOSVIII-H
TK100A10N1	100	±20	100	45	3.2	3.8	140	55	TO-220SIS	U-MOSVIII-H
TK100G10N1 *	100	±20	100	TBD	(2.6)	(3.2)	TBD	TBD	TO-220SM	U-MOSVIII-H
TK(50)E12N1 *	120	±20	(50)	TBD	(6.6)	(8)	TBD	TBD	TO-220	U-MOSVIII-H
TK(50)A12N1 *	120	±20	(50)	40	(6.7)	(8.1)	TBD	TBD	TO-220SIS	U-MOSVIII-H

*: Under development(All specs are preliminary.)

6-1 Super-Junction DTMOS Series ($V_{DSS} = 600\text{ V}, 650\text{ V}$)

The DTMOS devices employ a super-junction structure that enables an ultra-low on-resistance with the maximum V_{DSS} rating of 600 V or 650 V. The DTMOS Series helps improve the efficiency and reduce the size of electronic equipment. Additionally, the latest DTMOSIV (under development) Series further reduces on-resistance thanks to the reduced R_{on-A} and thus helps optimize product design.

Product Lineup

Part Number	Absolute Maximum Ratings					Series				
	V_{DSS} (V)	I_D (A)	$R_{DS(ON)}$ Max (Ω) $V_{GS} = 10\text{ V}$	Q_g Typ. (nC)	Package					
TK6A60W *	600	6.2	0.75	12	TO-220SIS	DTMOSIV				
TK10A60W *		9.7	0.38	20	TO-220SIS					
TK12A60U		12	0.4	14	TO-220SIS	DTMOSII				
TK12E60U					TO-220					
TK12J60U					TO-3P(N)					
TK12X60U					TFP					
TK12A60W *		11.5	0.3	25	TO-220SIS	DTMOSIV				
TK15A60U					TO-220SIS					
TK15E60U		15	0.3	17	TO-220	DTMOSII				
TK15J60U					TO-3P(N)					
TK15X60U		600	15.8	0.31	40	TFP	DTMOSIV			
TK16A60W *						15.8		0.19	27	TO-220SIS
TK20A60U										TO-220
TK20E60U						20		0.19	27	TO-3P(N)
TK20J60U	TO-3P(N)									
TK20X60U	40					0.08		55	TFP	
TK31A60W *									TO-220SIS	
TK31J60W *	30.8					0.088		87	TO-3P(N)	DTMOSIV
TK39J60W *									TO-3P(N)	
TK40J60U	38.8					0.065		110	TO-3P(N)	DTMOSII
TK40M60U									TO-3P(N)IS	
TK50J60U	50					0.065		67	TO-3P(N)	DTMOSIV
TK62J60W *									TO-3P(N)	
TK13A65U	650					13		0.38	17	TO-220SIS
TK13J65U		TO-3P(N)								
TK17A65U		TO-220SIS								
TK17J65U		TO-3P(N)								

*: Under development

Reduced $R_{DS(ON)}$ due to the Use of Super-Junction Technology

Compared to the π -MOS Series, the DTMOS Series is characterized by the use of a super-junction structure to greatly reduce R_{on-A} . Additionally, the latest DTMOSIV provides an approximately 40% reduction in R_{on-A} over DTMOSI, making it possible to house a MOSFET with $R_{DS(ON)}$ of less than 100 m Ω in the TO-220SIS package. This leads to increases in power efficiency and power density.

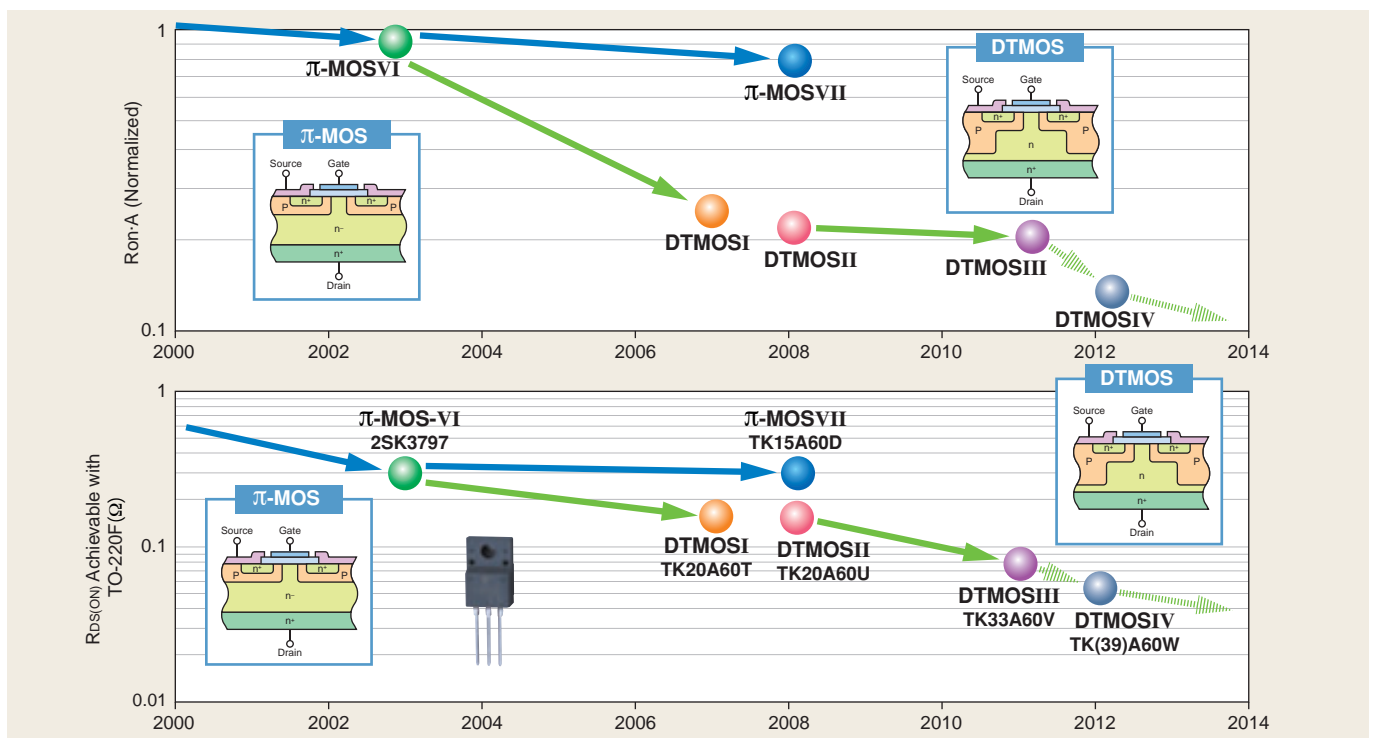

6-2 π -MOSVII Series ($V_{DSS} = 400\text{ V to }650\text{ V}$)

The latest addition to the π -MOS portfolio, the π -MOSVII Series offers reduced capacitances due to optimized chip design and is available with a greatly wider range of electrical characteristics.

■ Features

- 40% reduction in Q_g from π -MOSVI due to optimized chip design
- Available in 50-V steps of V_{DSS} and in finer steps of $R_{DS(ON)}$.
- Rated avalanche and reverse recovery current capabilities

■ Performance Comparisons Between π -MOSVII and π -MOSVI Devices (600 V/10 A)

Characteristic	Symbol	Test Conditions	π -MOSVII			π -MOSVI			Unit
			Min	Typ.	Max	Min	Typ.	Max	
Gate leakage current	$\pm I_{GSS}$	V_{GS} condition*, $V_{DS} = 0\text{ V}$	—	—	± 1	—	—	± 10	μA
Drain cut-off current	I_{DSS}	$V_{DS} = 600\text{ V}, V_{GS} = 0\text{ V}$	—	—	10	—	—	100	μA
Drain-source breakdown voltage	$V_{(BR)DSS}$	$I_D = +10\text{ mA}, V_{GS} = 0\text{ V}$	600	—	—	600	—	—	V
Gate threshold voltage	V_{th}	$V_{DS} = 10\text{ V}, I_D = 1\text{ mA}$	2.0	—	4.0	2.0	—	4.0	V
Drain-source on-resistance	$R_{DS(ON)}$	$V_{GS} = 10\text{ V}, I_D = 5\text{ A}$	—	—	0.75	—	—	0.75	Ω
Total gate charge	Q_g	$V_{DD} = 400\text{ V}, V_{GS} = 10\text{ V}, I_D = 10\text{ A}$	—	25	—	—	42	—	nC
Diode forward voltage	V_{DSF}	$I_{DR} = 10\text{ A}, V_{GS} = 0\text{ V}$	—	—	-1.7	—	—	-1.7	V

*: Test conditions: TK10A60D: $V_{GS} = \pm 30\text{ V}$, 2SK3569: $V_{GS} = \pm 25\text{ V}$

■ Efficiency Test Circuit

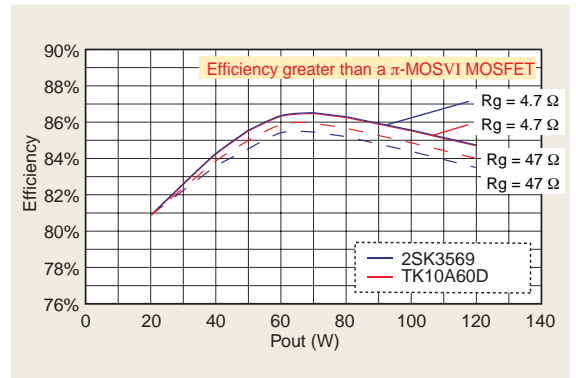
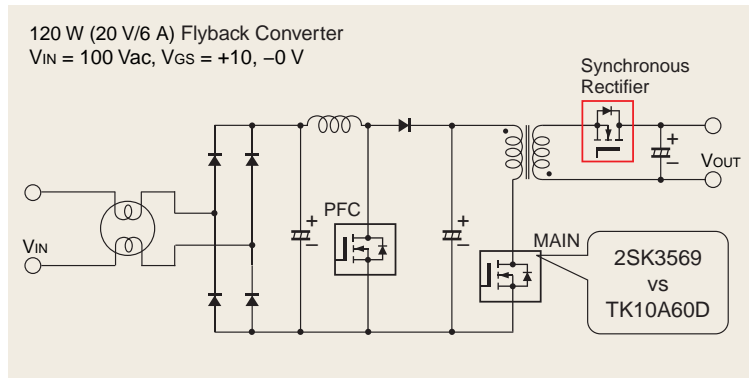

■ Product Lineup

Part Number	Absolute Maximum Ratings		R _{DS(ON)} (Ω) V _{GS} = 10 V	Equivalent Predecessor Part	Package	Part Number	Absolute Maximum Ratings		R _{DS(ON)} (Ω) V _{GS} = 10 V	Equivalent Predecessor Part	Package	
	V _{DSS} (V)	I _D (A)					V _{DSS} (V)	I _D (A)				
TK10X40D	400	10	0.55	2SK3499	TFP	TK6A55DA	550	5.5	1.48	—	TO-220SIS	
TK5A45DA	450	4.5	1.75	—	TO-220SIS	TK7A55D		7	1.25	—	TO-220SIS	
TK6A45DA		5.5	1.35	—	TO-220SIS	TK8A55DA		7.5	1.07	—	TO-220SIS	
TK7A45DA		6.5	1.2	—	TO-220SIS	TK9A55DA		8.5	0.86	—	TO-220SIS	
TK8A45DA		7.5	1.1	—	TO-220SIS	TK10A55D		10	0.72	—	TO-220SIS	
TK8A45D		8	0.9	—	TO-220SIS	TK11A55D		11	0.63	—	TO-220SIS	
TK9A45D		9	0.77	—	TO-220SIS	TK12A55D		12	0.57	—	TO-220SIS	
TK11A45D		11	0.62	2SK3869	TO-220SIS	TK12J55D		12	0.57	—	TO-3P(N)	
TK12A45D		12	0.52	—	TO-220SIS	TK13A55DA		12.5	0.48	—	TO-220SIS	
TK13A45D		13	0.46	2SK3743	TO-220SIS	TK14A55D		14	0.37	—	TO-220SIS	
TK14A45DA		13.5	0.41	—	TO-220SIS	TK16A55D		16	0.33	—	TO-220SIS	
TK16A45D		16	0.27	2SK3935	TO-220SIS	TK16J55D		16	0.37	—	TO-3P(N)	
TK19A45D		19	0.25	—	TO-220SIS	TK19J55D		19	0.33	—	TO-3P(N)	
TK3P50D		500	3	3	—	DPAK	TK2P60D	600	2	4.3	2SK2865	New PW-Mold
TK4A50D	4		2	—	TO-220SIS	TK2Q60D	2		5	2SK4002	New PW-Mold 2	
TK4P50D	4		2	—	DPAK	TK3A60DA	2.5		2.8	—	TO-220SIS	
TK5A50D	5		1.5	2SK3563	TO-220SIS	TK4A60DA	3.5		2.2	2SK3567	TO-220SIS	
TK5P50D	5		1.5	2SK3863/2SK4103	DPAK	TK4P60DA	3.5		2.2	2SK3975	DPAK	
TK6A50D	6		1.4	—	TO-220SIS	TK4Q60DA	3.5		2.2	2SK4003	New PW-Mold 2	
TK7A50D	7		1.2	—	TO-220SIS	TK4A60DB	3.7		2	—	TO-220SIS	
TK7P50D	7		1.22	—	DPAK	TK4P60DB	3.7		2	—	DPAK	
TK8A50DA	7.5		1.04	—	TO-220SIS	TK4A60D	4		1.7	—	TO-220SIS	
TK8A50D	8		0.85	2SK3561	TO-220SIS	TK4P60D	4		1.7	—	DPAK	
TK10A50D	10		0.72	—	TO-220SIS	TK5A60D	5		1.43	—	TO-220SIS	
TK11A50D	11		0.6	—	TO-220SIS	TK6A60D	6		1.25	2SK3562	TO-220SIS	
TK12A50D	12		0.52	2SK3568	TO-220SIS	TK8A60DA	7.5		1	2SK3667	TO-220SIS	
TK13A50DA	12.5	0.47	—	TO-220SIS	TK9A60D	9	0.83	—	TO-220SIS			
TK13A50D	13	0.4	2SK4012	TO-220SIS	TK10A60D	10	0.75	2SK3569	TO-220SIS			
TK15J50D	15	0.4	2SK4107	TO-3P(N)	TK11A60D	11	0.65	—	TO-220SIS			
TK15A50D	15	0.3	2SK3934	TO-220SIS	TK12A60D	12	0.55	—	TO-220SIS			
TK18A50D	18	0.27	—	TO-220SIS	TK13A60D	13	0.43	2SK3797	TO-220SIS			
TK20J50D	20	0.27	2SK4108	TO-3P(N)	TK15A60D	15	0.37	—	TO-220SIS			
TK4A53D	525	4	1.7	—	TO-220SIS	TK2A65D	650	2	3.26	—	TO-220SIS	
TK5A53D		5	1.5	2SK3563	TO-220SIS	TK3A65DA		2.5	2.51	—	TO-220SIS	
TK5P53D		5	1.5	—	DPAK	TK3A65D		3	2.25	—	TO-220SIS	
TK6A53D		6	1.3	—	TO-220SIS	TK4A65DA		3.5	2	—	TO-220SIS	
TK6P53D		6	1.3	—	DPAK	TK5A65DA		4.5	1.67	—	TO-220SIS	
TK12A53D		12	0.58	—	TO-220SIS	TK5A65D		5	1.43	—	TO-220SIS	
TK12X53D		12	0.58	2SK3398	TFP	TK6A65D		6	1.11	—	TO-220SIS	
TK4A55DA		550	3.5	2.45	—	TO-220SIS		TK7A65D	7	0.98	—	TO-220SIS
TK4P55DA			3.5	2.45	—	DPAK		TK8A65D	8	0.84	—	TO-220SIS
TK4A55D			4	1.9	—	TO-220SIS		TK11A65D	11	0.7	—	TO-220SIS
TK4P55D			4	1.88	—	DPAK		TK12A65D	12	0.54	—	TO-220SIS
TK5A55D			5	1.7	—	TO-220SIS		TK13A65D	13	0.47	—	TO-220SIS

6-3 New π -MOSVII Series (V_{DSS} = 200 V to 300 V)

In addition to the π -MOSVII devices with a V_{DSS} of 400 to 650 V, Toshiba has launched those with a V_{DSS} of 200 to 300 V.

■ Product Lineup

Part Number	Absolute Maximum Ratings			Package	Equivalent Predecessor Part
	V _{DSS} (V)	I _D (A)	R _{DS(ON)} Max (Ω) V _{GS} = 10 V		
TK9A20DA	200	8.5	0.4	TO-220SIS	2SK2350,2SK2381
TK15A20D		15	0.18	TO-220SIS	2SK2382,2SK2965
TK20A20D		20	0.109	TO-220SIS	—
TK25A20D		25	0.07	TO-220SIS	—
TK40J20D		40	0.044	TO-3P(N)	2SK3176
TK70J20D		70	0.027	TO-3P(N)	—
TK8A25DA		250	7.5	0.5	TO-220SIS
TK8P25DA	DPAK				—
TK13A25D	13		0.25	TO-220SIS	2SK2508
TK13P25D				DPAK	—
TK13E25D				TO-220	—
TK17A25D	300	17	0.15	TO-220SIS	—
TK20A25D		20	0.1	TO-220SIS	2SK3994
TK30J25D		30	0.06	TO-3P(N)	2SK2967
TK18A30D		18	0.139	TO-220SIS	—
TK50J30D	50	0.052	TO-3P(N)	—	

6-4 π -MOS Series■ π -MOSVI Series ($V_{DSS} = 450\text{ V to }600\text{ V}$)

Series	Part Number	Absolute Maximum Ratings		$R_{DS(ON)}$ Max (Ω)	Q_g Typ. (nC)	C_{iss} Typ. (pF)	Equivalent Predecessor Part	Package
		V_{DSS} (V)	I_D (A)	$V_{GS} = 10\text{ V}$				
π -MOSVI	2SK3766	450	2	2.45	8	270	2SK3543	TO-220SIS
	2SK3767	600	2	4.5	9	320	2SK3067	TO-220SIS

■ π -MOSIV Series ($V_{DSS} = 800\text{ V to }900\text{ V}$)

Series	Part Number	Absolute Maximum Ratings		$R_{DS(ON)}$ Max (Ω)	Q_g Typ. (nC)	C_{iss} Typ. (pF)	Equivalent Predecessor Part	Package
		V_{DSS} (V)	I_D (A)	$V_{GS} = 10\text{ V}$				
π -MOSIV	2SK3633	800	7	1.7	35	1500	2SK2746	TO-3P(N)
	2SK3879		6.5	1.7	35	1500	—	TO-220FL/SM
	2SK3880		6.5	1.7	35	1500	—	TO-3P(N)IS
	2SK4013		6	1.7	45	1400	—	TO-220SIS
	TK1P90A	900	1	9	13	320	2SK3301	New PW-Mold
	TK1Q90A		1	9	13	320	—	New PW-Mold2
	2SK3566		2.5	6.4	12	470	2SK2718	TO-220SIS
	2SK3564		3	4.3	17	700	2SK2700	TO-220SIS
	2SK3565		5	2.5	28	1150	2SK2717	TO-220SIS
	2SK3742		5	2.5	25	1150	2SK2717	TO-220SIS
	2SK3700		5	2.5	28	1150	2SK2610	TO-3P(N)
	2SK4014		6	2.0	45	1400	—	TO-220SIS
	2SK4115		7	2.0	45	1650	2SK2749	TO-3P(N)
	2SK3799		8	1.3	60	2200	—	TO-220SIS
	2SK3473	9	1.6	38	1450	—	TO-3P(N)	
	2SK3878	9	1.3	60	2200	2SK2611	TO-3P(N)	
	2SK4207	13	0.95	45	2790	—	TO-3P(N)	

■ L^2 - π -MOSV and VI Series ($V_{DSS} = 30\text{ V to }100\text{ V}$)

Part Number	V_{DSS} (V)	I_D (A)	P_D (W)	Package	$R_{DS(ON)}$ (Ω)				$R_{DS(ON)}$ (Ω)				Q_g Typ. (nC)
					Typ.	Max	V_{GS} (V)	I_D (A)	Typ.	Max	V_{GS} (V)	I_D (A)	
2SJ511	-30	-2	0.5	PW-Mini	0.32	0.45	-10	-1	0.55	0.76	-4	-1	5.5
2SJ360	-60	-1	0.5	PW-Mini	0.55	0.73	-10	-0.5	0.86	1.2	-4	-0.5	6.5
2SK2964	30	2	0.5	PW-Mini	0.13	0.18	10	1	0.18	0.25	4	1	5.8
2SK2615	60	2	0.5	PW-Mini	0.23	0.3	10	1	0.33	0.44	4	1	6
2SK3658	60	2	0.5	PW-Mini	0.23	0.3	10	1	0.33	0.44	4	1	5
2SK2963	100	1	0.5	PW-Mini	0.5	0.7	10	0.5	0.65	0.95	4	0.5	6.3

■ π -MOSV Series ($V_{DSS} = 150\text{ V to }250\text{ V}$)

Applications	Part Number	Absolute Maximum Ratings			Package	$R_{DS(ON)}$ (Ω)				Q_g Typ. (nC)
		V_{DSS} (V)	I_D (A)	P_D (W)		Typ.	Max	V_{GS} (V)	I_D (A)	
DC-DC converters Monitors	2SJ567	-200	-2.5	20	New PW-Mold	1.6	2.0	-10	-1.5	10
	2SJ680	-200	-2.5	20	New PW-Mold2	1.6	2.0	-10	-1.5	10
Motor controllers	2SJ610	-250	-2	20	New PW-Mold	1.85	2.55	-10	-1.0	24
	2SK2992	200	1	1.5	PW-Mini	2.2	3.5	10	0.5	3

■ π -MOSV Series ($V_{DSS} = 400\text{ V to }700\text{ V}$)

Applications	Part Number	Absolute Maximum Ratings			Package	$R_{DS(ON)}$ (Ω)				Q_g Typ. (nC)
		V_{DSS} (V)	I_D (A)	P_D (W)		Typ.	Max	V_{GS} (V)	I_D (A)	
115-V AC Switching power supplies Ballast inverters Motor controllers	2SK3499	400	10	80	TFP	0.4	0.55	10	5	34
	2SK2862	500	3	25	TO-220NIS	2.9	3.2	10	1	9
	2SK3466	500	5	50	TO-220FL/SM	1.35	1.5	10	5	17
	2SK2917	500	18	90	TO-3P(N)IS	0.21	0.27	10	10	80
	2SK3132	500	50	250	TO-3P(L)	0.07	0.095	10	25	280
	2SK2865	600	2	20	New PW-Mold	4.2	5.0	10	1	9
	2SK4002	600	2	20	New PW-Mold2	4.2	5	10	1	9
	2SK3975	600	3	20	New PW-Mold	1.7	2.2	10	1.5	20
	2SK3130	600	6	40	TO-220NIS	1.26	1.55	10	3	30

■ π -MOSIII Series ($V_{DSS} = 800\text{ V to }1000\text{ V}$)

Part Number	Absolute Maximum Ratings			Package	$R_{DS(ON)}$ (Ω)				Q_g Typ. (nC)
	V_{DSS} (V)	I_D (A)	P_D (W)		Typ.	Max	V_{GS} (V)	I_D (A)	
2SK3301	900	1	20	PW-Mold	15	20	10	0.5	6
2SK2719	900	3	125	TO-3P(N)	3.7	4.3	10	1.5	25
2SK2847	900	8	85	TO-3P(N)IS	1.05	1.25	10	4.0	58
2SK3017	900	8.5	90	TO-3P(N)IS	1.2	1.4	10	4.0	70
2SK2968	900	10	150	TO-3P(N)	1.05	1.25	10	4	70

7-1 Alphanumeric Index of Part Numbers

Part Number	Series	Package	Main Characteristics			Page
			V _{DSS} (V)	I _D (A)	R _{DS(ON)} Max (Ω)	
2SJ168	π-MOSIII	S-MINI	-60	-0.2	2	6,37
2SJ360	L ² -π-MOSV	PW-Mini	-60	-1	0.73	8,44
2SJ511	L ² -π-MOSV	PW-Mini	-30	-2	0.45	8,44
2SJ567	π-MOSV	New PW-Mold	-200	-2.5	2	8,44
2SJ610	π-MOSV	New PW-Mold	-250	-2	2.55	9,44
2SJ680	π-MOSV	New PW-Mold2	-200	-2.5	2	8,44
2SK1486	π-MOSIII.5	TO-3P (L)	300	32	0.095	15
2SK2274	π-MOSII.5	TO-220NIS	700	5	1.7	11
2SK2608	π-MOSIII	TO-220AB	900	3	4.3	-
2SK2615	L ² -π-MOSV	PW-Mini	60	2	0.3	8,44
2SK2719	π-MOSIII	TO-3P (N)	900	3	4.3	9,44
2SK2847	π-MOSIII	TO-3P (N)IS	900	8	1.4	11,44
2SK2862	π-MOSV	TO-220NIS	500	3	3.2	9,44
2SK2865	π-MOSV	New PW-Mold	600	2	5	9,44
2SK2917	π-MOSV	TO-3P (N)IS	500	18	0.27	13,44
2SK2963	L ² -π-MOSV	PW-Mini	100	1	0.7	8,44
2SK2964	L ² -π-MOSV	PW-Mini	30	2	0.18	8,44
2SK2968	π-MOSIII	TO-3P (N)	900	10	1.25	11,44
2SK2992	π-MOSV	PW-Mini	200	1	3.5	8,44
2SK3017	π-MOSIII	TO-3P (N)IS	900	8.5	1.25	11,44
2SK3130	π-MOSV	TO-220NIS	600	6	1.55	44
2SK3132	π-MOSV	TO-3P (L)	500	50	0.095	15,44
2SK3466	π-MOSV	TFP	500	5	1.5	11,44
2SK3499	π-MOSV	TFP	400	10	0.55	44
2SK3564	π-MOSIV	TO-220SIS	900	3	4.3	9,44
2SK3565	π-MOSIV	TO-220SIS	900	5	2.5	11,44
2SK3566	π-MOSIV	TO-220SIS	900	2.5	6.4	9,44
2SK3633	π-MOSIV	TO-3P (N)	800	7	1.7	11,44
2SK3658	L ² -π-MOSV	PW-Mini	60	2	0.3	8,44
2SK3742	π-MOSIV	TO-220SIS	900	5	2.5	11,44
2SK3767	π-MOSVI	TO-220SIS	600	2	4.5	9,44
2SK3799	π-MOSIV	TO-220SIS	900	8	1.3	11,44
2SK3878	π-MOSIV	TO-3P (N)	900	9	1.3	11,44
2SK3880	π-MOSIV	TO-3P (N)IS	800	6.5	1.7	11,44
2SK3975	π-MOSV	New PW-Mold	600	3	2.2	9,44
2SK4002	π-MOSV	New PW-Mold2	600	2	5	9,44
2SK4013	π-MOSIV	TO-220SIS	800	6	1.7	11,44
2SK4014	π-MOSIV	TO-220SIS	900	6	2	11,44
2SK4115	π-MOSIV	TO-3P (N)	900	7	2	11,44
2SK4207	π-MOSIV	TO-3P (N)	900	13	0.95	13,44
SSM3J09FU	π-MOSVI	USM	-30	-0.2	4.2	6,37
SSM3J112TU	U-MOSII	UFM	-30	-1.1	0.79	8,28
SSM3J113TU	U-MOSIII	UFM	-20	-1.7	0.169	28
SSM3J117TU	U-MOSII	UFM	-30	-2	0.225	8,28
SSM3J118TU	U-MOSII	UFM	-30	-1.4	0.48	8,28
SSM3J130TU	U-MOSVI	UFM	-20	-4.4	0.0258	10,28
SSM3J132TU	U-MOSVI	UFM	-12	-5.4	0.017	10,28
SSM3J133TU	U-MOSVI	UFM	-20	-5.5	0.0298	10,28
SSM3J134TU	U-MOSVI	UFM	-20	-3.2	0.093	8,28
SSM3J135TU	U-MOSVI	UFM	-20	-3.0	0.103	8,28
SSM3J15CT	π-MOSVI	CST3	-30	-0.1	32	6,37
SSM3J15F	π-MOSVI	S-MINI	-30	-0.1	32	6,37
SSM3J15FU	π-MOSVI	USM	-30	-0.1	32	6,37
SSM3J15FV	π-MOSVI	VESM	-30	-0.1	32	37
SSM3J305T	U-MOSII	TSM	-30	-1.7	0.477	8,28
SSM3J306T	U-MOSII	TSM	-30	-2.4	0.225	8,28
SSM3J325F	U-MOSVI	S-MINI	-20	-2	0.155	8,28
SSM3J326T	U-MOSVI	TSM	-30	-5.6	0.0457	10,28

Part Number	Series	Package	Main Characteristics			Page
			V _{DSS} (V)	I _D (A)	R _{DS(ON)} Max (Ω)	
SSM3J327R	U-MOSVI	SOT-23F	-20	-3.9	0.093	8,28
SSM3J328R	U-MOSVI	SOT-23F	-20	-6	0.0298	10,28
SSM3J331R	U-MOSVI	SOT-23F	-20	-4	0.055	8,28
SSM3J332R	U-MOSVI	SOT-23F	-30	-6	0.042	10,28
SSM3J334R	U-MOSVI	SOT-23F	-30	-4	0.071	8,28
SSM3J35CT	π-MOSVI	CST3	-20	-0.1	44	6,37
SSM3J35FS	π-MOSVI	SSM	-20	-0.1	44	6,37
SSM3J35MFV	π-MOSVI	VESM	-20	-0.1	44	6,37
SSM3J36FS	U-MOSIII	SSM	-20	-0.33	3.6	6,37
SSM3J36MFV	U-MOSIII	VESM	-20	-0.33	3.6	6,37
SSM3J36TU	U-MOSIII	UFM	-20	-0.33	3.6	6,37
SSM3J46CTB	U-MOSVI	CST3B	-20	-2	0.103	8,28
SSM3J56MFV	U-MOSVI	VESM	-20	-0.8	0.39	6,28
SSM3K09FU	π-MOSVI	USM	30	0.4	1.2	6,37
SSM3K106TU	π-MOSVII	UFM	20	1.2	0.53	8,29
SSM3K116TU	U-MOSIII	UFM	30	2.2	0.1	8,29
SSM3K119TU	U-MOSIII	UFM	30	2.5	0.074	8,29
SSM3K121TU	U-MOSIII	UFM	20	3.2	0.048	8,29
SSM3K122TU	U-MOSIII	UFM	20	2	0.123	8,29
SSM3K123TU	U-MOSIII	UFM	20	4.2	0.028	10,29
SSM3K124TU	π-MOSVII	UFM	30	2.4	0.12	8,29
SSM3K127TU	U-MOSIII	UFM	30	2	0.123	8,29
SSM3K131TU	U-MOSIV	UFM	30	6.0	0.0415	10,29
SSM3K15ACT	U-MOSIII	CST3	30	0.1	3.6	6,37
SSM3K15AFS	U-MOSIII	SSM	30	0.1	3.6	6,37
SSM3K15AFU	U-MOSIII	USM	30	0.1	3.6	6,37
SSM3K15AMFV	U-MOSIII	VESM	30	0.1	3.6	6,37
SSM3K17FU	π-MOSV	USM	50	0.1	40	6,37
SSM3K301T	U-MOSIII	TSM	20	3.5	0.056	8,29
SSM3K309T	U-MOSIII	TSM	20	4.7	0.031	10,29
SSM3K310T	U-MOSIII	TSM	20	5	0.028	10,29
SSM3K316T	U-MOSIII	TSM	30	4	0.065	29
SSM3K318T	U-MOSIV	TSM	60	2.5	0.145	8,29
SSM3K320T	U-MOSIV	TSM	30	4.2	0.077	10,29
SSM3K329R	U-MOSIII	SOT-23F	30	3.5	0.126	8,29
SSM3K333R	U-MOSVII-H	SOT-23F	30	6	0.042	10,29
SSM3K335R	U-MOSVII-H	SOT-23F	30	6	0.038	10,29
SSM3K336R	U-MOSVII-H	SOT-23F	30	4	0.11	8,29
SSM3K35CT	π-MOSVI	CST3	20	0.18	20	6,37
SSM3K35FS	π-MOSVI	SSM	20	0.18	20	6,37
SSM3K35MFV	π-MOSVI	VESM	20	0.18	20	6,37
SSM3K36MFV	U-MOSIII	VESM	20	0.5	1.52	6,37
SSM3K36TU	U-MOSIII	UFM	20	0.5	1.52	6,37
SSM3K37CT	U-MOSIII	CST3	20	0.2	3.1	6,37
SSM3K37FS	U-MOSIII	SSM	20	0.2	3.1	6,37
SSM3K37MFV	U-MOSIII	VESM	20	0.25	5.6	6,37
SSM3K43FS	U-MOSIII	SSM	20	0.5	1.52	6
SSM3K44FS	π-MOSVI	SSM	30	0.1	7	6,37
SSM3K44MFV	π-MOSVI	VESM	30	0.1	7	6,37
SSM3K56FS	U-MOSVII-H	SSM	20	0.8	0.26	6,29
SSM3K7002BF	U-MOSIV	S-MINI	60	0.2	3.3	6,37
SSM3K7002BFS	U-MOSIV	SSM	60	0.2	3.3	6,37
SSM3K7002BFU	U-MOSIV	USM	60	0.2	3.3	37
SSM4K27CT	U-MOSIII	CST4	20	0.5	0.205	6,29
SSM5G02TU	U-MOSII	UFV	-12	-1	0.16	8,31
SSM5G09TU	U-MOSII	UFV	-12	-1.5	0.13	8,31
SSM5G10TU	U-MOSIII	UFV	-20	-1.5	0.213	8,31

Part Number	Series	Package	Main Characteristics			Page
			V _{bss} (V)	I _b (A)	R _{DS(ON)} Max (Ω)	
SSM5G11TU	U-MOSIII-H	UFV	-30	-1.4	0.403	8,31
SSM5H01TU	U-MOSII	UFV	30	1.4	0.45	8,31
SSM5H07TU	π -MOSVII	UFV	20	1.2	0.54	8,31
SSM5H08TU	U-MOSIII	UFV	20	1.5	0.16	8,31
SSM5H10TU	U-MOSIII	UFV	20	1.6	0.119	8,31
SSM5H11TU	U-MOSIII	UFV	30	1.6	0.182	8,31
SSM5H16TU	U-MOSIII	UFV	30	1.9	0.133	8,31
SSM5H14F	U-MOSIII	SMV	30	3	0.078	8,31
SSM5N15FE	π -MOSVI	ES6	30	0.1	7	6,37
SSM5N15FU	π -MOSVI	US6	30	0.1	7	37
SSM5N16FE	π -MOSVI	ES6	20	0.1	15	6,37
SSM5N16FU	π -MOSVI	US6	20	0.1	15	37
SSM5P15FE	π -MOSVI	ES6	-30	-0.1	32	6,37
SSM5P15FU	π -MOSVI	US6	-30	-0.1	32	6,37
SSM5P16FE	π -MOSVI	ES6	-20	-0.1	45	6,37
SSM5P16FU	π -MOSVI	US6	-20	-0.1	45	37
SSM6E01TU	U-MOSIII	UF6	-12	-1	0.16	8,30
SSM6E03TU	U-MOSIII	UF6	-20	-1.8	0.144	8,30
SSM6G18NU	U-MOSVI	UDFN6	-20	-2.0	0.112	8,31
SSM6J207FE	U-MOSII	ES6	-30	-1.3	0.491	8,28
SSM6J212FE	U-MOSVI	ES6	-20	-4.0	0.0407	8,28
SSM6J213FE	U-MOSVI	ES6	-20	-2.6	0.103	8,28
SSM6J214FE	U-MOSVI	ES6	-30	-3.6	0.057	8,28
SSM6J215FE	U-MOSVI	ES6	-20	-3.4	0.059	8,28
SSM6J401TU	U-MOSIII	UF6	-30	-2.5	0.145	8,28
SSM6J402TU	U-MOSIII	UF6	-30	-2	0.225	8,28
SSM6J409TU	U-MOSV	UF6	-20	-9.5	0.0221	10,28
SSM6J412TU	U-MOSVI	UF6	-20	-4.0	0.0427	8,28
SSM6J414TU	U-MOSVI	UF6	-20	-6	0.0221	10,28
SSM6J501NU	U-MOSVI	UDFN6B	-20	-10	0.0153	10,28
SSM6J502NU	U-MOSVI	UDFN6B	-20	-6.0	0.0231	10,28
SSM6J503NU	U-MOSVI	UDFN6B	-20	-6.0	0.0324	10,28
SSM6J505NU	U-MOSVI	UDFN6B	-12	-10	0.01	10,28
SSM6K202FE	U-MOSIII	ES6	30	2.3	0.085	8,29
SSM6K204FE	U-MOSIII	ES6	20	2	0.126	8,29
SSM6K208FE	U-MOSIII	ES6	30	1.9	0.133	8,29
SSM6K210FE	U-MOSIII	ES6	30	1.4	0.371	8,29
SSM6K211FE	U-MOSIII	ES6	20	3.2	0.047	8,29
SSM6K30FE	π -MOSVII	ES6	20	1.2	0.42	8,29
SSM6K34TU	U-MOSIII	UF6	30	3	0.077	8,29
SSM6K403TU	U-MOSIII	UF6	20	4.2	0.028	10,29
SSM6K404TU	U-MOSIII	UF6	20	3	0.055	8,29
SSM6K405TU	U-MOSIII	UF6	20	2	0.126	8,29
SSM6K406TU	U-MOSIV	UF6	30	4.4	0.0385	10,29
SSM6K407TU	π -MOSV	UF6	60	2	0.44	8,29
SSM6K411TU	U-MOSIV	UF6	20	10	0.012	10,29
SSM6K504NU	U-MOSVII-H	UDFN6	30	9	0.03	29
SSM6L12TU	U-MOSIII	UF6	-20	-0.5	0.26	6,30
SSM6L14FE	U-MOSIII	ES6	-20	-0.72	0.3	6,30
SSM6L35FE	U-MOSIII	ES6	-20	-0.1	44	6,37
SSM6L35FU	U-MOSIII	US6	-20	-0.1	44	6,37
SSM6L36FE	U-MOSIII	ES6	-20	-0.33	3.6	6,37
SSM6L36TU	U-MOSIII	UF6	-20	-0.33	3.6	6,37
SSM6L39TU	U-MOSIII	UF6	-20	-1.5	0.213	8,30
SSM6L40TU	U-MOSIII	UF6	-30	-1.4	0.403	8,30
SSM6N15AFE	U-MOSIII	ES6	30	0.1	3.6	6,37
SSM6N15AFU	U-MOSIII	US5	30	0.1	3.6	6,37
SSM6N17FU	π -MOSV	US6	50	0.1	40	6,37
SSM6N24TU	U-MOSIII	UF6	30	0.5	0.145	6,30
SSM6N35FE	π -MOSVI	ES6	20	0.18	20	6,37
SSM6N35FU	π -MOSVI	US6	20	0.18	20	6,37

Part Number	Series	Package	Main Characteristics			Page
			V _{bss} (V)	I _b (A)	R _{DS(ON)} Max (Ω)	
SSM6N36FE	U-MOSIII	ES6	20	0.5	1.52	6,37
SSM6N37CTD	U-MOSIII	CST6D	20	0.25	5.6	6,37
SSM6N37FE	U-MOSIII	ES6	20	0.25	5.6	6,37
SSM6N37FU	U-MOSIII	US6	20	0.25	3.1	6,37
SSM6N39TU	U-MOSIII	UF6	20	1.6	0.119	8,30
SSM6N40TU	U-MOSIII	UF6	30	1.6	0.182	8,30
SSM6N42FE	U-MOSIII	ES6	20	0.8	0.24	6,30
SSM6N43FU	U-MOSIII	US6	20	0.5	1.52	6
SSM6N44FE	π -MOSVI	ES6	30	0.1	7	6,37
SSM6N44FU	π -MOSVI	US6	30	0.1	7	6,37
SSM6N55NU	U-MOSVII-H	UDFN6	30	4	0.043	8,30
SSM6N7002BFE	U-MOSIV	ES6	60	0.2	3.3	6,37
SSM6N7002BFU	U-MOSIV	US6	60	0.2	3.3	6,37
SSM6P09FU	π -MOSVI	US6	-30	-0.2	4.2	6,37
SSM6P15FE	π -MOSVI	ES6	-30	-0.1	32	6,37
SSM6P15FU	π -MOSVI	US6	-30	-0.1	32	6,37
SSM6P16FE	π -MOSVI	ES6	-20	-0.1	45	37
SSM6P16FU	π -MOSVI	US6	-20	-0.1	45	37
SSM6P25TU	U-MOSIII	UF6	-20	-0.5	0.26	30
SSM6P35FE	π -MOSVI	ES6	-20	-0.1	44	6,37
SSM6P35FU	π -MOSVI	US6	-20	-0.1	44	6,37
SSM6P36FE	U-MOSIII	ES6	-20	-0.33	3.6	6,37
SSM6P36TU	U-MOSIII	UF6	-20	-0.33	3.6	6,37
SSM6P39TU	U-MOSIII	UF6	-20	-1.5	0.213	8,30
SSM6P40TU	U-MOSIII	UF6	-30	-1.4	0.403	8,30
SSM6P41FE	U-MOSV	ES6	-20	-0.72	0.3	6,30
SSM6P47NU	U-MOSVI	UDFN6	-20	-4	0.095	8,30
SSM6P49NU	U-MOSVI	UDFN6	-20	-4	0.056	8,30
SSM6P54TU	U-MOSIV	UF6	-20	-1.2	0.228	8,30
SSM6Q01NU	U-MOSVI	UDFN6	-20	4	0.059	8,31
TJ100F04M3L	U-MOSVI	TO-220SM(W)	-40	-100	0.036	14,39
TJ10S04M3L	U-MOSVI	DPAK+	-40	-10	0.044	10,38
TJ11A10M3	U-MOSVI	TO-220SIS	-100	-11	0.13	12,39
TJ150F04M3L	U-MOSVI	TO-220SM(W)	-40	-150	0.0028	14,39
TJ150F06M3L	U-MOSVI	TO-220SM(W)	-60	-150	0.0056	14,39
TJ15P04M3	U-MOSVI	DPAK	-40	-15	0.036	12,36
TJ15S06M3L	U-MOSVI	DPAK+	-60	-15	0.05	12,38
TJ20A10M3	U-MOSVI	TO-220SIS	-100	-20	0.09	12,39
TJ20S04M3L	U-MOSVI	DPAK+	-40	-20	0.0222	12,38
TJ30S06M3L	U-MOSVI	DPAK+	-60	-30	0.0218	14,38
TJ40S04M3L	U-MOSVI	DPAK+	-40	-40	0.0091	14,38
TJ50S06M3L	U-MOSVI	DPAK+	-60	-50	0.0138	14,38
TJ60S04M3L	U-MOSVI	DPAK+	-40	-60	0.0063	14,38
TJ60S06M3L	U-MOSVI	DPAK+	-60	-60	0.0112	14,38
TJ70A06J3	U-MOSIII	TO-220SIS	-60	-70	0.008	14,39
TJ80S04M3L	U-MOSVI	DPAK+	-40	-80	0.0052	14,38
TJ8S06M3L	U-MOSVI	DPAK+	-60	-8	0.104	10,38
TJ9A10M3	U-MOSVI	TO-220SIS	-100	-9	0.17	10,39
TK100A08N1	U-MOSVIII-H	TO-220SIS	80	100	0.0032	14,40
TK100A10N1	U-MOSVIII-H	TO-220SIS	100	100	0.0038	14,40
TK100E08N1	U-MOSVIII-H	TO-220	80	100	0.0032	14,40
TK100E10N1	U-MOSVIII-H	TO-220	100	100	0.0034	14,40
TK100F04K3	U-MOSIV	TO-220SM(W)	40	100	0.003	14,39
TK100F04K3L	U-MOSIV	TO-220SM(W)	40	100	0.003	14,39
TK100F06K3	U-MOSIV	TO-220SM(W)	60	100	0.005	14,39
TK100G08N1	U-MOSVIII-H	TO-220SM	80	100	(0.003)	14,40
TK100G10N1	U-MOSVIII-H	TO-220SM	100	100	(0.0032)	14,40
TK10A50D	π -MOSVII	TO-220SIS	500	10	0.72	11,43
TK10A55D	π -MOSVII	TO-220SIS	550	10	0.72	11,43
TK10A60D	π -MOSVII	TO-220SIS	600	10	0.75	11,43
TK10S04K3L	U-MOSIV	DPAK+	40	10	0.028	10,38

Part Number	Series	Package	Main Characteristics			Page
			V _{DS} (V)	I _D (A)	R _{DS(ON) Max} (Ω)	
TK10X40D	π-MOSVII	TFP	400	10	0.55	11,43
TK11A45D	π-MOSVII	TO-220SIS	450	11	0.62	13,43
TK11A50D	π-MOSVII	TO-220SIS	500	11	0.6	13,43
TK11A55D	π-MOSVII	TO-220SIS	550	11	0.63	13,43
TK11A60D	π-MOSVII	TO-220SIS	600	11	0.65	13,43
TK11A65D	π-MOSVII	TO-220SIS	650	11	0.7	13,43
TK12A10K3	U-MOSIV	TO-220SIS	100	12	0.08	12,39
TK12A45D	π-MOSVII	TO-220SIS	450	12	0.52	13,43
TK12A50D	π-MOSVII	TO-220SIS	500	12	0.52	13,43
TK12A53D	π-MOSVII	TO-220SIS	525	12	0.58	13,43
TK12A55D	π-MOSVII	TO-220SIS	550	12	0.57	13,43
TK12A60D	π-MOSVII	TO-220SIS	600	12	0.55	13,43
TK12A60U	DTMOSII	TO-220SIS	600	12	0.4	13,41
TK12A65D	π-MOSVII	TO-220SIS	650	12	0.54	13,43
TK12E60U	DTMOSII	TO-220	600	12	0.4	13,41
TK12J55D	π-MOSVII	TO-3P(N)	550	12	0.57	13,43
TK12J60U	DTMOSII	TO-3P(N)	600	12	0.4	13,41
TK12X53D	π-MOSVII	TFP	550	12	0.58	13,43
TK12X60U	DTMOSII	TFP	600	12	0.42	13,41
TK130F06K3	U-MOSIV	TO-220SM(W)	60	130	0.0034	14,39
TK13A25D	π-MOSVII	TO-220SIS	250	13	0.25	13,43
TK13E25D	π-MOSVII	TO-220	250	13	0.25	13,43
TK13P25D	π-MOSVII	DPAK	250	13	0.25	13,43
TK13A45D	π-MOSVII	TO-220SIS	450	13	0.46	13,43
TK13A50D	π-MOSVII	TO-220SIS	500	13	0.4	13,43
TK13A50DA	π-MOSVII	TO-220SIS	500	12.5	0.47	13,43
TK13A55DA	π-MOSVII	TO-220SIS	550	12.5	0.48	13,43
TK13A60D	π-MOSVII	TO-220SIS	600	13	0.43	13,43
TK13A65U	DTMOSII	TO-220SIS	650	13	0.38	13,41
TK13A65D	π-MOSVII	TO-220SIS	650	13	0.47	13,43
TK13J65U	DTMOSII	TO-3P(N)	650	13	0.38	13,41
TK14A45D	π-MOSVII	TO-220SIS	450	14	0.34	13
TK14A45DA	π-MOSVII	TO-220SIS	450	13.5	0.41	13,43
TK14A55D	π-MOSVII	TO-220SIS	550	14	0.37	13,43
TK150F04K3	U-MOSIV	TO-220SM(W)	40	150	0.0021	14,39
TK150F04K3L	U-MOSIV	TO-220SM(W)	40	150	0.0021	14,39
TK15A20D	π-MOSVII	TO-220SIS	200	15	0.4	12,43
TK15A50D	π-MOSVII	TO-220SIS	500	15	0.3	13,43
TK15A60D	π-MOSVII	TO-220SIS	600	15	0.37	13,43
TK15A60U	DTMOSII	TO-220SIS	600	15	0.3	13,41
TK15E60U	DTMOSII	TO-220	600	15	0.3	13,41
TK15J50D	π-MOSVII	TO-3P(N)	500	15	0.4	13,43
TK15J60T	DTMOSI	TO-3P(N)	600	15	0.28	-
TK15J60U	DTMOSII	TO-3P(N)	600	15	0.3	13,41
TK15X60U	DTMOSII	TFP	600	15	0.31	13,41
TK16A45D	π-MOSVII	TO-220SIS	450	16	0.27	13,43
TK16A55D	π-MOSVII	TO-220SIS	550	16	0.33	13,43
TK16J55D	π-MOSVII	TO-3P(N)	550	16	0.37	13,43
TK17A65U	DTMOSII	TO-220SIS	650	17	0.26	13,41
TK17J65U	DTMOSII	TO-3P(N)	650	17	0.26	13,41
TK18A30D	π-MOSVII	TO-220SIS	300	18	0.139	13,43
TK18A50D	π-MOSVII	TO-220SIS	500	18	0.27	13,43
TK18E10K3	U-MOSIV	TO-220	100	18	0.042	12,40
TK19A45D	π-MOSVII	TO-220SIS	450	19	0.25	13,43
TK19J55D	π-MOSVII	TO-220SIS	600	5	1.43	13,43
TK1P90A	π-MOSIV	New PW-Mold	900	1	9	9,44
TK1Q90A	π-MOSIV	New PW-Mold2	900	1	9	9,44
TK20A25D	π-MOSVII	TO-220SIS	250	20	0.1	13,43
TK20A60T	DTMOSI	TO-220SIS	600	20	0.19	-
TK20A60U	DTMOSII	TO-220SIS	600	20	0.19	13,41
TK20E60U	DTMOSII	TO-220	600	20	0.19	13,41

Part Number	Series	Package	Main Characteristics			Page
			V _{DS} (V)	I _D (A)	R _{DS(ON) Max} (Ω)	
TK20J50D	π-MOSVII	TO-3P(N)	500	20	0.27	13,43
TK20J60T	DTMOSI	TO-3P(N)	600	20	0.19	-
TK20J60U	DTMOSII	TO-3P(N)	600	20	0.19	13,41
TK20P04M1	U-MOSVI-H	DPAK	40	20	0.029	12,24,36
TK20S04K3L	U-MOSIV	DPAK+	40	20	0.014	12,38
TK20S06K3L	U-MOSIV	DPAK+	60	20	0.029	12,38
TK20X60U	DTMOSII	TFP	600	20	0.20	13,41
TK22A10N1	U-MOSVIII-H	TO-220SIS	100	22	0.0138	12,40
TK22E10N1	U-MOSVIII-H	TO-220	100	22	0.0138	12,40
TK22J60V	DTMOSIII	TO-3P(N)	600	22	0.15	-
TK25A10K3	U-MOSIV	TO-220SIS	100	25	0.04	14,39
TK25A20D	π-MOSVII	TO-220SIS	200	25	0.07	15,43
TK25E06K3	U-MOSIV	TO-220	60	25	0.018	14,40
TK2A65D	π-MOSVII	TO-220SIS	650	2	3.26	9,43
TK2P60D	π-MOSVII	New PW-Mold	600	2	4.3	9,43
TK2Q60D	π-MOSVII	New PW-Mold2	600	2	4.3	9,43
TK30S06K3L	U-MOSIV	DPAK+	60	30	0.018	14,38
TK34A10N1	U-MOSVIII-H	TO-220SIS	100	34	0.0095	14,40
TK34E10N1	U-MOSVIII-H	TO-220	100	34	0.0095	14,40
TK35S04K3L	U-MOSIV	DPAK+	40	35	0.0103	14,38
TK3A60DA	π-MOSVII	TO-220SIS	600	2.5	2.8	9,43
TK3A65D	π-MOSVII	TO-220SIS	650	3	2.25	9,43
TK3A65DA	π-MOSVII	TO-220SIS	650	2.5	2.51	9,43
TK3P50D	π-MOSVII	DPAK	500	3	3	9,43
TK40A08K3	U-MOSIV	TO-220SIS	75	40	0.009	14,40
TK40A10K3	U-MOSIV	TO-220SIS	100	40	0.015	14,40
TK40A10N1	U-MOSVIII-H	TO-220SIS	100	40	0.0082	14,40
TK40E10K3	U-MOSIV	TO-220	100	40	0.015	14,40
TK40E10N1	U-MOSVIII-H	TO-220	100	40	0.0082	14,40
TK40J60T	DTMOSI	TO-3P(N)	600	40	0.08	-
TK40J60U	DTMOSII	TO-3P(N)	600	40	0.08	15,41
TK40M60U	DTMOSII	TO-3P(N)IS	600	40	0.08	15,41
TK40P03M1	U-MOSVI-H	DPAK	30	40	0.0108	14,24,36
TK40P04M1	U-MOSVI-H	DPAK	40	40	0.011	14,24,36
TK40S10K3Z	U-MOSIV	DPAK+	100	40	0.018	14,38
TK45P03M1	U-MOSVI-H	DPAK	30	45	0.0097	14,24,36
TK45S06K3L	U-MOSIV	DPAK+	60	45	0.0105	14,38
TK46A08N1	U-MOSVIII-H	TO-220SIS	80	46	(0.0086)	14,40
TK46E08N1	U-MOSVIII-H	TO-220	80	46	(0.0086)	14,40
TK4A50D	π-MOSVII	TO-220SIS	500	4	2	9,43
TK4A53D	π-MOSVII	TO-220SIS	525	4	1.7	9,43
TK4A55D	π-MOSVII	TO-220SIS	550	4	1.9	9,43
TK4A55DA	π-MOSVII	TO-220SIS	550	3.5	2.45	9,43
TK4A60D	π-MOSVII	TO-220SIS	600	4	1.7	9,43
TK4A60DA	π-MOSVII	TO-220SIS	600	3.5	2.2	9,43
TK4A60DB	π-MOSVII	TO-220SIS	600	3.7	2	9,43
TK4A65DA	π-MOSVII	TO-220SIS	650	3.5	2	9,43
TK4P50D	π-MOSVII	DPAK	500	4	2	9,43
TK4P55D	π-MOSVII	DPAK	550	4	1.88	9,43
TK4P55DA	π-MOSVII	DPAK	550	3.5	2.45	9,43
TK4P60D	π-MOSVII	DPAK	600	4	1.7	43
TK4P60DA	π-MOSVII	DPAK	600	3.5	2.2	9,43
TK4P60DB	π-MOSVII	DPAK	600	3.7	2	9,43
TK4Q60DA	π-MOSVII	New PW-Mold2	600	3.5	2.2	43
TK50A04K3	U-MOSIV	TO-220SIS	40	50	0.0035	14,39
TK(50)A12N1	U-MOSVIII-H	TO-220SIS	120	50	(0.0081)	14,40
TK50E06K3A	U-MOSIV	TO-220	60	50	0.0085	14,40
TK50E08K3	U-MOSIV	TO-220	75	50	0.012	14,40
TK(50)E12N1	U-MOSVIII-H	TO-220	120	50	(0.008)	14,40
TK50J60U	DTMOSII	TO-3P(N)	600	50	0.65	15,41
TK50P03M1	U-MOSVI-H	DPAK	30	50	0.0075	14,24,36

Part Number	Series	Package	Main Characteristics			Page
			V _{DS} (V)	I _D (A)	R _{DS(ON)} Max (Ω)	
TK50P04M1	U-MOSVI-H	DPAK	40	50	0.0087	14,24,36
TK50S04K3L	U-MOSIV	DPAK+	40	50	0.0054	14,38
TK55F08K3L	U-MOSIV	TO-220SM(W)	75	55	0.0102	14,39
TK5A45DA	π-MOSVII	TO-220SIS	450	4.5	1.75	11,43
TK5A50D	π-MOSVII	TO-220SIS	500	5	1.5	11,43
TK5A53D	π-MOSVII	TO-220SIS	525	5	1.5	11,43
TK5A55D	π-MOSVII	TO-220SIS	550	5	1.7	11,43
TK5A60D	π-MOSVII	TO-220SIS	600	5	1.43	11,43
TK5A65D	π-MOSVII	TO-220SIS	650	5	1.3	11,43
TK5A65DA	π-MOSVII	TO-220SIS	650	4.5	1.67	11,43
TK5P50D	π-MOSVII	DPAK	500	5	1.5	11,43
TK5P53D	π-MOSVII	DPAK	525	5	1.5	11,43
TK60E08K3	U-MOSIV	TO-220	75	60	0.009	14,40
TK60F08K3	U-MOSIV	TO-220SM(W)	75	60	0.0085	14,39
TK60P03M1	U-MOSVI-H	DPAK	30	60	0.0064	14,24,36
TK60S06K3L	U-MOSIV	DPAK+	60	60	0.008	14,38
TK65A10N1	U-MOSVIII-H	TO-220SIS	100	65	0.0048	14,40
TK65E10N1	U-MOSVIII-H	TO-220	100	65	0.0048	14,40
TK65G10N1	U-MOSVIII-H	TO-220SM	100	65	0.0046	14,40
TK65S04K3L	U-MOSIV	DPAK+	40	65	0.0045	14,38
TK6A45DA	π-MOSVII	TO-220SIS	450	5.5	1.35	11,43
TK6A50D	π-MOSVII	TO-220(W)	500	6	1.4	11,43
TK6A53D	π-MOSVII	TO-220SIS	525	6	1.3	11,43
TK6A55DA	π-MOSVII	TO-220SIS	550	5.5	1.48	11,43
TK6A60D	π-MOSVII	TO-220SIS	600	6	1.25	11,43
TK6A65D	π-MOSVII	TO-220SIS	650	6	1.11	11,43
TK6P53D	π-MOSVII	DPAK	525	6	1.3	11,43
TK72A08N1	U-MOSVIII-H	TO-220SIS	80	72	(0.0047)	14,40
TK72E08N1	U-MOSVIII-H	TO-220	80	72	(0.0044)	14,40
TK75A06K3	U-MOSIV	TO-220SIS	60	75	0.0055	14,40
TK7A45DA	π-MOSVII	TO-220SIS	450	6.5	1.2	11,43
TK7A50D	π-MOSVII	TO-220SIS	500	7	1.22	11,43
TK7A55D	π-MOSVII	TO-220SIS	550	7	1.25	11,43
TK7A65D	π-MOSVII	TO-220SIS	650	7	0.98	11,43
TK7P50D	π-MOSVII	DPAK	500	7	1.22	11,43
TK80A08K3	U-MOSIV	TO-220SIS	75	80	0.0045	14,40
TK80E06K3A	U-MOSIV	TO-220	60	80	0.0058	14,40
TK80F04K3L	U-MOSIV	TO-220SM(W)	40	80	0.0045	14,39
TK80F06K3L	U-MOSIV	TO-220SM(W)	60	80	0.0078	14,39
TK80F08K3	U-MOSIV	TO-220SM(W)	75	80	0.0043	14,39
TK80S04K3L	U-MOSIV	DPAK+	40	80	0.0031	14,38
TK80S06K3L	U-MOSIV	DPAK+	60	80	0.0055	14,38
TK8A10K3	U-MOSIV	TO-220SIS	100	8	0.12	10,39
TK8A25DA	π-MOSVII	TO-220SIS	250	7.5	0.5	11,43
TK8A45D	π-MOSVII	TO-220SIS	450	8	0.9	11,43
TK8A45DA	π-MOSVII	TO-220SIS	450	7.5	1.1	11,43
TK8A50D	π-MOSVII	TO-220SIS	500	8	0.85	11,43
TK8A50DA	π-MOSVII	TO-220SIS	500	7.5	1.04	11,43
TK8A55DA	π-MOSVII	TO-220SIS	550	7.5	1.07	11,43
TK8A60DA	π-MOSVII	TO-220SIS	600	7.5	1.04	11,43
TK8A65D	π-MOSVII	TO-220SIS	650	8	0.84	11,43
TK8P25DA	π-MOSVII	DPAK	250	7.5	0.5	11,43
TK8S06K3L	U-MOSIV	DPAK+	600	8	0.054	10,38
TK9A45D	π-MOSVII	TO-220SIS	450	9	0.77	11,43
TK9A55DA	π-MOSVII	TO-220SIS	550	8.5	0.86	11,43
TK9A60D	π-MOSVII	TO-220SIS	600	9	0.83	11,43
TPC6008-H	U-MOSVI-H	VS-6	30	5.9	0.06	10,24,31
TPC6009-H	U-MOSVI-H	VS-6	40	5.3	0.081	10,24,31
TPC6010-H	U-MOSVI-H	VS-6	60	6.1	0.059	10,25,31
TPC6011	U-MOSIV	VS-6	30	6	0.02	10,31
TPC6012	U-MOSIV	VS-6	20	6	0.032	10,31

Part Number	Series	Package	Main Characteristics			Page
			V _{DS} (V)	I _D (A)	R _{DS(ON)} Max (Ω)	
TPC6067	U-MOSVII	VS-6	30	(6)	(0.023)	31
TPC6109-H	U-MOSIII-H	VS-6	-30	-5	0.059	10,25,31
TPC6110	U-MOSVI	VS-6	-30	-4.5	0.056	10,31
TPC6111	U-MOSV	VS-6	-20	-5.5	0.04	10,31
TPC6113	U-MOSVI	VS-6	-20	-5	0.056	10,31
TPC6130	U-MOSVI	VS-6	-20	-2.8	0.106	8,31
TPC8045-H	U-MOSVI-H	SOP-8	40	18	0.0039	12,24,34
TPC8046-H	U-MOSVI-H	SOP-8	40	18	0.0057	12,24,34
TPC8047-H	U-MOSVI-H	SOP-8	40	16	0.0076	12,24,34
TPC8048-H	U-MOSVI-H	SOP-8	60	16	0.0069	12,25,34
TPC8049-H	U-MOSVI-H	SOP-8	60	13	0.0107	12,25,34
TPC8050-H	U-MOSVI-H	SOP-8	60	11	0.0145	12,25,34
TPC8051-H	U-MOSVI-H	SOP-8	80	13	0.0097	12,25,34
TPC8052-H	U-MOSVI-H	SOP-8	40	12	0.0115	12,24,34
TPC8053-H	U-MOSVI-H	SOP-8	60	9	0.0225	10,25,34
TPC8055-H	U-MOSVII-H	SOP-8	30	18	0.0021	12,24,34
TPC8056-H	U-MOSVII-H	SOP-8	30	18	0.0024	12,24,34
TPC8057-H	U-MOSVII-H	SOP-8	30	18	0.0028	12,24,34
TPC8058-H	U-MOSVII-H	SOP-8	30	18	0.0032	12,24,34
TPC8059-H	U-MOSVII-H	SOP-8	30	18	0.004	12,24,34
TPC8062-H	U-MOSVII-H	SOP-8	30	18	0.0058	12,24,34
TPC8063-H	U-MOSVII-H	SOP-8	30	17	0.007	12,24,34
TPC8064-H	U-MOSVII-H	SOP-8	30	16	0.0084	12,24,34
TPC8065-H	U-MOSVII-H	SOP-8	30	13	0.0116	12,24,27,34
TPC8066-H	U-MOSVII-H	SOP-8	30	11	0.016	12,24,34
TPC8067-H	U-MOSVII-H	SOP-8	30	9	0.025	10,24,34
TPC8073	U-MOSVII	SOP-8	30	18	0.0047	12,27,34
TPC8074	U-MOSVII	SOP-8	30	17	0.0065	12,27,34
TPC8075	U-MOSVII	SOP-8	33	18	0.0026	12,27,34
TPC8076	U-MOSVII	SOP-8	30	18	0.0049	12,27,34
TPC8078	U-MOSVII	SOP-8	33	18	0.0022	12,27,34
TPC8080	U-MOSVII	SOP-8	30	18	0.0028	12,27,34
TPC8081	U-MOSVII	SOP-8	30	18	0.0033	12,27,34
TPC8082	U-MOSVII	SOP-8	30	18	0.0041	12,27,34
TPC8084	U-MOSVII	SOP-8	33	17	0.0069	12,27,34
TPC8085	U-MOSVII	SOP-8	30	18	0.0047	12,27,34
TPC8086	U-MOSVII	SOP-8	30	17	0.0064	12,27,34
TPC8087	U-MOSVII	SOP-8	30	18	0.0024	12,27,34
TPC8088	U-MOSVII	SOP-8	30	18	0.0024	12,27,34
TPC8092	U-MOSVII	SOP-8	30	15	0.009	12,27,34
TPC8120	U-MOSVI	SOP-8	-30	-18	0.0032	12,27,34
TPC8123	U-MOSVI	SOP-8	-30	-11	0.009	12,27,34
TPC8124	U-MOSVI	SOP-8	-30	-12	0.008	12,27,34
TPC8125	U-MOSVI	SOP-8	-30	-10	0.013	10,27,34
TPC8126	U-MOSVI	SOP-8	-30	-11	0.01	12,27,34
TPC8127	U-MOSVI	SOP-8	-30	-13	0.0065	12,27,34
TPC8128	U-MOSVI	SOP-8	-30	-16	0.005	12,27,34
TPC8129	U-MOSVI	SOP-8	-30	-9	0.022	10,27,34
TPC8132	U-MOSVI	SOP-8	-40	-7	0.025	10,27,34
TPC8133	U-MOSVI	SOP-8	-40	-9	0.015	10,27,34
TPC8134	U-MOSVI	SOP-8	-40	-5	0.052	10,27,34
TPC8223-H	U-MOSVII-H	SOP-8	30	9	0.017	10,25,34
TPC8224-H	U-MOSVII-H	SOP-8	30	8	0.026	10,25,34
TPC8227-H	U-MOSVI-H	SOP-8	40	TBD	(0.033)	25,34
TPC8228-H	U-MOSVI-H	SOP-8	60	TBD	(0.057)	25,34
TPC8229-H	U-MOSVI-H	SOP-8	80	TBD	(0.080)	25,34
TPC8407	U-MOSVI-U-MOSVII-H	SOP-8	-30/30	-7.4/9	0.023/0.017	10,34
TPC8408	U-MOSVI-U-MOSVII-H	SOP-8	-40/40	-5.3/6.1	0.043/0.032	10,34
TPCA8011-H	U-MOSIII-H	SOP Advance	20	40	0.0035	14,24,35
TPCA8045-H	U-MOSVI-H	SOP Advance	40	46	0.0036	14,24,35
TPCA8046-H	U-MOSVI-H	SOP Advance	40	38	0.0054	14,24,35

Part Number	Series	Package	Main Characteristics			Page
			V _{bss} (V)	I _b (A)	R _{DS(ON)} Max (Ω)	
TPCA8047-H	U-MOSVI-H	SOP Advance	40	32	0.0073	14,24,35
TPCA8048-H	U-MOSVI-H	SOP Advance	60	35	0.0066	14,25,35
TPCA8049-H	U-MOSVI-H	SOP Advance	60	28	0.0104	14,25,35
TPCA8050-H	U-MOSVI-H	SOP Advance	60	24	0.0142	14,25,35
TPCA8051-H	U-MOSVI-H	SOP Advance	80	28	0.0094	14,25,35
TPCA8052-H	U-MOSVI-H	SOP Advance	40	20	0.0113	12,24,35
TPCA8053-H	U-MOSVI-H	SOP Advance	60	15	0.0223	12,25,35
TPCA8055-H	U-MOSVII-H	SOP Advance	30	56	0.0019	14,24,35
TPCA8056-H	U-MOSVII-H	SOP Advance	30	48	0.0022	14,24,35
TPCA8057-H	U-MOSVII-H	SOP Advance	30	42	0.0026	14,24,35
TPCA8058-H	U-MOSVII-H	SOP Advance	30	38	0.003	14,24,35
TPCA8059-H	U-MOSVII-H	SOP Advance	30	32	0.0038	14,24,35
TPCA8062-H	U-MOSVII-H	SOP Advance	30	28	0.0056	14,24,35
TPCA8063-H	U-MOSVII-H	SOP Advance	30	22	0.0068	12,24,35
TPCA8064-H	U-MOSVII-H	SOP Advance	30	20	0.0082	12,24,35
TPCA8065-H	U-MOSVII-H	SOP Advance	30	16	0.0114	12,24,35
TPCA8068-H	U-MOSVII-H	SOP Advance	30	15	0.0116	12,24,27,35
TPCA8075	U-MOSVII	SOP Advance	33	48	0.0024	14,27,35
TPCA8078	U-MOSVII	SOP Advance	33	54	0.0021	14,27,35
TPCA8080	U-MOSVII	SOP Advance	30	42	0.0026	14,27,35
TPCA8081	U-MOSVII	SOP Advance	30	38	0.0031	14,27,35
TPCA8082	U-MOSVII	SOP Advance	30	32	0.0039	14,27,35
TPCA8087	U-MOSVII	SOP Advance	30	56	0.0019	14,27,35
TPCA8088	U-MOSVII	SOP Advance	30	48	0.0022	14,27,35
TPCA8109	U-MOSVI	SOP Advance	-30	-24	0.009	14,27,35
TPCA8120	U-MOSVI	SOP Advance	-30	-45	0.003	14,27,35
TPCA8128	U-MOSVI	SOP Advance	-30	-34	0.0048	14,27,35
TPCA8131	U-MOSVI	SOP Advance	30	-13	0.017	12,27,35
TPCA8A08-H	U-MOSV-H	SOP Advance	30	38	0.0042	-
TPCA8A09-H	U-MOSVII-H	SOP Advance	30	51	0.0023	14,25,35
TPCA8A10-H	U-MOSVII-H	SOP Advance	30	40	0.003	14,25,35
TPCA8A11-H	U-MOSVII-H	SOP Advance	30	35	0.0036	14,25,35
TPCC8007	U-MOSIV	TSON Advance	20	27	0.0046	14,27,33
TPCC8008	U-MOSIV	TSON Advance	30	25	0.0068	14,27,33
TPCC8009	U-MOSIV	TSON Advance	30	24	0.007	14,27,33
TPCC8061-H	U-MOSVI-H	TSON Advance	30	8	0.026	10,24,33
TPCC8062-H	U-MOSVII-H	TSON Advance	30	27	0.0056	14,24,33
TPCC8064-H	U-MOSVII-H	TSON Advance	30	19	0.0082	12,24,33
TPCC8065-H	U-MOSVII-H	TSON Advance	30	13	0.0114	12,24,27,33
TPCC8066-H	U-MOSVII-H	TSON Advance	30	11	0.015	12,24,33
TPCC8067-H	U-MOSVII-H	TSON Advance	30	9	0.025	10,24,33
TPCC8068-H	U-MOSVII-H	TSON Advance	30	13	0.0116	12,24,27,33
TPCC8073	U-MOSVII	TSON Advance	30	27	0.0045	14,27,33
TPCC8074	U-MOSVII	TSON Advance	30	20	0.0063	12,27,33
TPCC8076	U-MOSVII	TSON Advance	33	27	0.0046	14,27,33
TPCC8084	U-MOSVII	TSON Advance	33	21	0.0067	12,27,33
TPCC8093	U-MOSVI	TSON Advance	20	(21)	(0.0058)	12,27,33
TPCC8103	U-MOSV	TSON Advance	-30	-18	0.012	12,27,33
TPCC8104	U-MOSVI	TSON Advance	-30	-20	0.0088	12,27,33
TPCC8105	U-MOSVI	TSON Advance	-30	-23	0.0078	12,27,33
TPCC8131	U-MOSVI	TSON Advance	-30	-10	0.0176	10,27,33
TPCC8136	U-MOSVI	TSON Advance	-20	(-9.4)	(0.016)	10,27,33
TPCC8137	U-MOSVIII	TSON Advance	-20	-13	0.01	12,27,33
TPCC8138	U-MOSVIII	TSON Advance	-20	-18	0.0075	12,27,33
TPCF8003	U-MOSIV	VS-8	20	7	0.018	10,32
TPCF8004	U-MOSVII	VS-8	30	7	0.024	10,32
TPCF8105	U-MOSVI	VS-8	-20	-6	0.03	10,32
TPCF8107	U-MOSVI	VS-8	-30	-6	0.028	10,32
TPCF8108	U-MOSVI	VS-8	-20	-7	0.026	10,32
TPCF8201	U-MOSIII	VS-8	20	3	0.049	8,32
TPCF8304	U-MOSIV	VS-8	-30	-3.2	0.072	8,32

Part Number	Series	Package	Main Characteristics			Page
			V _{bss} (V)	I _b (A)	R _{DS(ON)} Max (Ω)	
TPCF8305	U-MOSVI	VS-8	-20	-4	0.058	8,32
TPCF8306	U-MOSVII	VS-8	-30	-3.2	0.072	8,32
TPCF8402	U-MOSIV/U-MOSIII	VS-8	-30/30	-3.2/4	0.072/0.05	8,32
TPCF8B01	U-MOSIII	VS-8	-20	-2.7	0.11	8,32
TPCL4201	U-MOSV	Chip LGA	20	6	0.031	10,27,33
TPCL4202	U-MOSV	Chip LGA	30	6	0.04	10,27,33
TPCL4203	U-MOSV	Chip LGA	24	6	0.036	10,27,33
TPCP8004	U-MOSIV	PS-8	30	8.3	0.0085	10,32
TPCP8006	U-MOSIV	PS-8	20	9.1	0.01	10,32
TPCP8007-H	U-MOSVI-H	PS-8	60	5	0.057	10,25,32
TPCP8105	U-MOSVI	PS-8	-20	-5.2	0.017	32
TPCP8106	U-MOSVI	PS-8	-30	-7.2	0.033	10,32
TPCP8203	U-MOSIII	PS-8	40	4.7	0.04	32
TPCP8204	U-MOSIV	PS-8	30	4.2	0.05	10,32
TPCP8205-H	U-MOSVI-H	PS-8	30	6.5	0.026	10,25,32
TPCP8206	U-MOSVII	PS-8	20	(6)	0.026	10,32
TPCP8303	U-MOSV	PS-8	-20	-3.8	0.046	8,32
TPCP8305	U-MOSVI	PS-8	-20	-6	0.03	10,32
TPCP8306	U-MOSVI	PS-8	-20	-4	0.058	8,32
TPCP8404	U-MOSV/U-MOSIV	PS-8	-30/30	-4/4	0.05/0.05	8,32
TPCP8405	U-MOSVI/U-MOSVI-H	PS-8	-30/30	-6/6.5	0.031/0.026	10,32
TPCP8406	U-MOSVII/U-MOSVI-H	PS-8	-40/40	-5/6	0.0432/0.032	10,32
TPCP8AA1	U-MOSII	PS-8	20	1.6	0.105	8,33
TPCP8BA1	U-MOSII	PS-8	-20	-1.3	0.18	8,33
TPH14006NH	U-MOSVIII-H	SOP Advance	60	(14)	(0.014)	25,35
TPH4R606NH	U-MOSVIII-H	SOP Advance	60	(32)	(0.0046)	25,35
TPH5R906NH	U-MOSVIII-H	SOP Advance	60	(28)	(0.0059)	25,35
TPH7R506NH	U-MOSVIII-H	SOP Advance	60	(22)	(0.0075)	25,35
TPN2R503NC	U-MOSVIII	TSON Advance	30	(40)	(0.0025)	27,33

8-1 Products To Be Discontinued

The products to be discontinued are listed in the left-hand column below.
When ordering, please choose from the replacement products in the right-hand column.

To Be Discontinued					Replacement Products				
Part Number	Electrical Characteristics			Package	Part Number	Electrical Characteristics			Package
	V _{DSS} (V)	I _D (A)	R _{DS(ON)} Max(Ω)			V _{DSS} (V)	I _D (A)	R _{DS(ON)} Max(Ω)	
2SJ148	-60	-0.2	2	TO-92	2SJ168	-60	-0.2	2	S-MINI
2SJ167	-60	-0.2	2	N-MINI	2SJ168	-60	-0.2	2	S-MINI
2SJ200	-180	-10	0.83	TO-3P(N)	-	-	-	-	-
2SJ201	-200	-12	0.63	TO-3P(L)	-	-	-	-	-
2SJ304	-60	-14	0.12	TO-220NIS2	TJ8S06M3L	-60	-8	0.104	DPAK+
2SJ312	-60	-14	0.12	TO-220FL/SM	TJ8S06M3L	-60	-8	0.104	DPAK+
2SJ313	-180	-1	5	TO-220NIS	2SJ680	-200	-2.5	2	New PW-Mold2
2SJ334	-60	-30	0.038	TO-220NIS2	TJ30S06M3L	-60	-30	0.0218	DPAK+
2SJ338	-180	-1	5	New PW-Mold	-	-	-	-	-
2SJ342	-50	-0.05	50	N-MINI	2SJ343	-50	-0.05	50	S-MINI
2SJ345	-20	-0.05	40	S-MINI	SSM3J16FU	-20	-0.1	45	USM
2SJ346	-20	-0.05	40	USM	SSM3J16FU	-20	-0.1	45	USM
2SJ347	-20	-0.05	40	SSM	SSM3J35FS	-20	-0.1	8	SSM
2SJ349	-60	-20	0.045	TO-220NIS2	TJ15S06M3L	-60	-15	0.05	DPAK+
2SJ377	-60	-5	0.19	New PW-Mold	TJ8S06M3L	-60	-8	0.104	DPAK+
2SJ380	-100	-12	0.21	TO-220NIS2	TJ9A10M3	-100	-9	0.17	TO-220SIS
2SJ401	-60	-20	0.045	TO-220FL/SM	TJ15S06M3L	-60	-15	0.05	DPAK+
2SJ402	-60	-30	0.038	TO-220FL/SM	TJ30S06M3L	-60	-30	0.0218	DPAK+
2SJ407	-200	-5	1	TO-220NIS	2SJ680	-200	-5	0.17	New PW-Mold2
2SJ412	-100	-16	0.21	TO-220FL/SM	TJ9A10M3	-100	-9	0.17	TO-220SIS
2SJ438	-60	-5	0.19	TO-220NIS	TJ8S06M3L	-60	-8	0.104	DPAK+
2SJ439	-16	-5	0.19	New PW-Mold	TPC6113	-20	-5	0.055	VS-6
2SJ440	-180	-9	0.8	TO-3P(N)IS	-	-	-	-	-
2SJ507	-60	-1	0.7	LSTM	-	-	-	-	-
2SJ508	-100	-1	1.9	PW-Mini	-	-	-	-	-
2SJ509	-100	-1	1.9	LSSTM	-	-	-	-	-
2SJ512	-250	-5	1.25	TO-220NIS	2SJ680	-200	-5	0.17	New PW-Mold2
2SJ516	-250	-6.5	0.8	TO-220NIS	2SJ680	-200	-5	0.17	New PW-Mold2
2SJ537	-50	-5	0.19	LSTM	-	-	-	-	-
2SJ618	-180	-10	0.37	TO-3P(N)	-	-	-	-	-
2SJ619	-100	-16	0.21	TFP	TJ9A10M3	-100	-9	0.17	TO-220SIS
2SK1061	60	0.2	1	N-MINI	SSM3K7002BF	60	0.2	2.1	S-MINI
2SK1381	100	50	0.032	TO-3P(N)	TK40E10K3	100	40	0.015	TO-220
2SK1382	100	60	0.02	TO-3P(L)	TK40E10K3	100	40	0.015	TO-220
2SK1529	-200	-12	0.63	TO-3P(N)	-	-	-	-	-
2SK1530	200	12	0.63	TO-3P(L)	-	-	-	-	-
2SK1825	50	0.05	50	N-MINI	SSM3K7002BF	60	0.2	2.1	S-MINI
2SK1826	50	0.05	50	S-MINI	SSM3K7002BF	60	0.2	2.1	S-MINI
2SK1827	50	0.05	50	USM	SSM3K7002BFU	60	0.2	2.1	USM
2SK1828	20	0.05	40	S-MINI	SSM3K15F	30	0.1	7	S-MINI
2SK1829	20	0.05	40	USM	SSM3K15AFU	30	0.1	3.6	USM
2SK1830	20	0.05	40	SSM	SSM3K15AFS	30	0.1	3.6	SSM
2SK2013	180	1	5	TO-220NIS	TK8A25DA	250	7.5	0.5	TO-220SIS
2SK2033	20	0.1	12	S-MINI	SSM3K15F	30	0.1	7	S-MINI
2SK2034	20	0.1	12	USM	SSM3K15AFU	30	0.1	3.6	USM
2SK2035	20	0.1	12	SSM	SSM3K15AFS	30	0.1	3.6	SSM
2SK2036	20	0.1	6	S-MINI	SSM3K15F	30	0.1	7	S-MINI
2SK2037	20	0.1	6	USM	SSM3K15AFU	30	0.1	3.6	USM
2SK2162	180	1	5	New PW-Mold	TK8P25DA	250	7.5	0.5	TO-220SIS
2SK2173	60	50	0.017	TO-3P(N)	TK25E06K3	60	25	0.018	TO-220
2SK2201	100	3	0.35	New PW-Mold	TK8A10K3	100	8	0.12	TO-220SIS
2SK2231	60	5	0.16	New PW-Mold	TPC8053-H	60	9	0.0225	SOP-8
2SK2232	60	25	0.046	TO-220NIS2	TK25E06K3	60	25	0.018	TO-220
2SK2233	60	45	0.03	TO-3P(N)	TK25E06K3	60	25	0.018	TO-220

To Be Discontinued					Replacement Products				
Part Number	Electrical Characteristics			Package	Part Number	Electrical Characteristics			Package
	V _{DSS} (V)	I _D (A)	R _{DS(ON)} Max(Ω)			V _{DSS} (V)	I _D (A)	R _{DS(ON)} Max(Ω)	
2SK2266	60	45	0.03	TO-220FL/SM	TK50E06K3A	60	50	0.0085	TO-220
2SK2267	60	60	0.011	TO-3P(L)	TK50E06K3A	60	50	0.0085	TO-220
2SK2311	60	25	0.046	TO-220FL/SM	TK25E06K3	60	25	0.018	TO-220
2SK2312	60	45	0.017	TO-220NIS2	TK25E06K3	60	25	0.018	TO-220
2SK2313	60	60	0.011	TO-3P(N)	TK50E06K3A	60	50	0.0085	TO-220
2SK2376	60	45	0.017	TO-220FL/SM	TK50E06K3A	60	50	0.0085	TO-220
2SK2385	60	36	0.03	TO-220NIS2	TK25E06K3	60	25	0.018	TO-220
2SK2391	100	20	0.085	TO-220NIS2	TK12A10K3	100	12	0.08	TO-220SIS
2SK2398	60	45	0.03	TO-3P(N)	TK50E06K3A	60	50	0.0085	TO-220
2SK2399	100	5	0.23	New PW-Mold	TK8A10K3	100	8	0.12	TO-220SIS
2SK2466	100	30	0.046	TO-220NIS2	TK25A10K3	100	25	0.04	TO-220SIS
2SK2493	16	5	0.1	New PW-Mold	TPCC8066-H	30	11	0.019	TSON Advance
2SK2507	50	25	0.046	TO-220NIS2	TK25E06K3	60	25	0.018	TO-220
2SK2549	16	2	0.29	PW-Mini	-	-	-	-	-
2SK2744	50	45	0.02	TO-3P(N)	TK50E06K3A	60	50	0.0085	TO-220
2SK2789	100	27	0.085	TO-220FL/SM	TK25A10K3	100	25	0.04	TO-220SIS
2SK2823	20	0.1	40	S-MINI	SSM3K35FS	20	0.18	20	SSM
2SK2824	20	0.1	40	USM	SSM3K35FS	20	0.18	20	SSM
2SK2825	20	0.1	40	SSM	SSM3K35FS	20	0.18	20	SSM
2SK2886	50	45	0.02	TO-220NIS2	TK25E06K3	60	25	0.018	TO-220
2SK2920	200	5	0.8	New PW-Mold	TK8P25DA	250	8	0.5	DPAK
2SK2962	100	1	0.7	LSTM	-	-	-	-	-
2SK2967	250	30	0.068	TO-3P(N)	TK30J25D	250	30	0.06	TO-3P(N)
2SK2989	50	5	0.15	LSTM	-	-	-	-	-
2SK2995	250	30	0.068	TO-3P(N)IS	TK30J25D	250	30	0.06	TO-3P(N)
2SK3051	50	45	0.03	TO-220FL/SM	TK25E06K3	60	25	0.018	TO-220
2SK3084	100	30	0.046	TO-220FL/SM	TK40E10K3	100	40	0.015	TO-220
2SK3089	30	40	0.03	TO-220FL/SM	TK40P03M1	30	40	0.0108	DPAK
2SK3090	30	45	0.02	TO-220FL/SM	TK45P03M1	30	45	0.0097	DPAK
2SK3127	30	45	0.012	TO-220FL/SM	TK45P03M1	30	45	0.0097	DPAK
2SK3128	30	60	0.012	TO-3P(N)	TPCA8065-H	30	16	0.0114	SOP Advance
2SK3176	200	30	0.052	TO-3P(N)	TK40J20D	200	40	0.044	TO-3P(N)
2SK3205	150	5	0.5	New PW-Mold	-	-	-	-	-
2SK3236	60	35	0.02	TO-220NIS2	TK25E06K3	60	25	0.018	TO-220
2SK3342	250	4.5	1	New PW-Mold	TK8P25DA	250	8	0.5	DPAK
2SK3387	150	18	0.12	TFP	-	-	-	-	-
2SK3388	250	20	0.105	TFP	TK20A25D	250	20	0.1	TO-220SIS
2SK3439	30	75	0.005	TFP	TPC8059-H	30	32	0.0038	SOP Advance
2SK3440	60	50	0.008	TFP	TK80F06K3L	60	80	0.0078	TO-220SM(W)
2SK3442	100	45	0.02	TFP	TK40E10K3	100	40	0.015	TO-220
2SK3443	150	30	0.055	TFP	-	-	-	-	-
2SK3444	200	25	0.082	TFP	TK25A20D	200	25	0.07	TO-220SIS
2SK3445	250	20	0.105	TFP	TK20A25D	250	20	0.1	TO-220SIS
2SK3462	250	3	1.7	New PW-Mold	TK8P25DA	250	8	0.5	DPAK
2SK3497	180	10	0.15	TO-3P(N)	TK40J20D	200	40	0.044	TO-3P(N)
2SK3625	200	25	0.082	TO-220SM	TK25A20D	200	25	0.07	TO-220SIS
2SK3662	60	35	0.0125	TO-220NIS2	TK50E06K3A	60	50	0.0085	TO-220
2SK3669	100	10	0.125	New PW-Mold	-	-	-	-	-
2SK3670	150	0.67	1.7	LSTM	-	-	-	-	-
2SK3842	60	75	0.0058	TFP	-	-	-	-	-
2SK3843	40	75	0.0035	TFP	-	-	-	-	-
2SK3844	60	45	0.0058	TO-220NIS2	TK75A06K3	60	75	0.0055	TO-220SIS
2SK3845	60	70	0.0058	TO-3P(N)	TK80E06K3A	60	80	0.0058	TO-220
2SK3846	40	26	0.018	TO-220NIS2	TK25E06K3	60	25	0.018	TO-220
2SK3847	40	32	0.018	TO-220FL/SM	TK40P04M1	40	40	0.011	DPAK
2SK3940	75	70	0.007	TO-3P(N)	-	-	-	-	-
2SK4018	100	3	0.35	New PW-Mold2	-	-	-	-	-
2SK4019	100	5	0.23	New PW-Mold2	-	-	-	-	-
2SK4020	200	5	0.8	New PW-Mold2	TK8P25DA	250	8	0.5	DPAK
2SK4021	250	4.5	1	New PW-Mold2	TK8P25DA	250	8	0.5	DPAK
2SK4022	250	3	1.7	New PW-Mold2	TK8P25DA	250	8	0.5	DPAK

To Be Discontinued				Replacement Products					
Part Number	Electrical Characteristics			Package	Part Number	Electrical Characteristics			Package
	V _{DSS} (V)	I _D (A)	R _{DS(ON)} Max(Ω)			V _{DSS} (V)	I _D (A)	R _{DS(ON)} Max(Ω)	
2SK4034	60	75	0.0058	TFP	—	—	—	—	
2SK982	60	0.2	1	TO-92	SSM3K7002BF	60	0.2	2.1	S-MINI
HN1J02FU	-20	-0.05	40	US6	SSM6P16FU	-20	-0.1	45	US6
HN1K02FU	20	0.05	40	US6	SSM6N37FU	20	0.25	2.2	US6
HN1K03FU	20	0.1	12	US6	SSM6N37FU	20	0.25	2.2	US6
HN1K04FU	50	0.05	50	US6	SSM6N7002BFU	60	0.2	2.1	US6
HN1K05FU	20	0.1	40	US6	SSM6N35FU	20	0.18	20	US6
HN1K06FU	20	0.1	6	US6	SSM6N15AFU	30	0.1	3.6	US6
HN1L02FU	20	0.05	40	US6	SSM6L35FU	20	0.18	20	US6
HN1L03FU	50	0.05	50	US6	—	—	—	—	
HN4K03JU	20	0.1	12	UFV	SSM5N15FU	30	0.1	7	USV
SSM3J01F	-30	-0.7	0.6	S-MINI	SSM3J332R	-30	-6	0.042	SOT-23F
SSM3J01T	-30	-1.7	0.6	TSM	SSM3J332R	-30	-6	0.042	SOT-23F
SSM3J02F	-30	-0.6	0.7	S-MINI	SSM3J332R	-30	-6	0.042	SOT-23F
SSM3J02T	-30	-1.5	0.7	TSM	SSM3J332R	-30	-6	0.042	SOT-23F
SSM3J05FU	-20	-0.2	4	USM	SSM3J36TU	-20	-0.33	3.6	UFM
SSM3J108TU	-20	-1.8	0.158	UFM	SSM3J135TU	-20	-3.0	0.103	UFM
SSM3J109TU	-20	-2	0.13	UFM	SSM3J135TU	-20	-3.0	0.103	UFM
SSM3J110TU	-20	-2.3	0.098	UFM	SSM3J134TU	-20	-3.2	0.093	UFM
SSM3J111TU	-20	-1	0.48	UFM	SSM3J113TU	-20	-1.7	0.169	UFM
SSM3J114TU	-20	-1.8	0.149	UFM	SSM3J135TU	-20	-3.0	0.103	UFM
SSM3J115TU	-20	-2.2	0.098	UFM	SSM3J134TU	-20	-3.2	0.093	UFM
SSM3J120TU	-20	-4	0.038	UFM	SSM3J133TU	-20	-5.5	0.0298	UFM
SSM3J13T	-12	-3	0.07	TSM	SSM3J328R	-20	-6	0.0298	SOT-23F
SSM3J14T	-30	-2.7	0.085	TSM	SSM3J334R	-30	-4	0.105	SOT-23F
SSM3J15TE	-30	-0.1	32	TESM	SSM3J15FV	-30	-0.1	32	VESM
SSM3J16CT	-20	-0.1	8	CST3	SSM3J35CT	-20	-0.1	8	CST3
SSM3J16FS	-20	-0.1	8	SSM	SSM3J35FS	-20	-0.1	8	SSM
SSM3J16FV	-20	-0.1	8	VESM	SSM3J35MFV	-20	-0.1	8	VESM
SSM3J16TE	-20	-0.1	45	TESM	SSM3J35MFV	-20	-0.1	8	VESM
SSM3J304T	-20	-2.3	0.127	TSM	SSM3J325F	-20	-2	0.15	S-MINI
SSM3J307T	-20	-5	0.031	TSM	SSM3J328R	-20	-6	0.03	SOT-23F
SSM3J312T	-12	-2.7	0.091	TSM	SSM3J327R	-20	-3.9	0.093	SOT-23F
SSM3J313T	-20	-1.6	0.268	TSM	SSM3J325F	-20	-2	0.15	S-MINI
SSM3J317T	-20	-3.6	0.107	TSM	SSM3J327R	-20	-3.9	0.093	SOT-23F
SSM3J321T	-20	-5.2	0.046	TSM	SSM3J328R	-20	-6	0.03	SOT-23F
SSM3J327F	-20	-3.5	0.095	S-MINI	SSM3J327R	-20	-3.9	0.093	SOT-23F
SSM3K01F	30	1.3	0.15	S-MINI	SSM3K329R	30	3.5	0.126	SOT-23F
SSM3K01T	30	3.2	0.12	TSM	SSM3K329R	30	3.5	0.126	SOT-23F
SSM3K02F	30	1	0.25	S-MINI	SSM3K329R	30	3.5	0.126	SOT-23F
SSM3K02T	30	2.5	0.1	TSM	SSM3K329R	30	3.5	0.126	SOT-23F
SSM3K03C	20	0.1	12	SS-CSP	SSM3K37CT	20	0.2	2.2	CST3
SSM3K03FE	20	0.1	12	ESM	SSM3J36FS	20	0.1	15	SSM
SSM3K03FV	20	0.1	12	VESM	SSM3K37MFV	20	0.25	3.02	VESM
SSM3K03TE	20	0.1	12	TESM	SSM3K37MFV	20	0.25	5.6	VESM
SSM3K04FE	20	0.1	12	ESM	SSM3K04FS	20	0.1	12	SSM
SSM3K05FU	20	0.4	0.8	USM	SSM3K36TU	20	0.5	0.66	UFM
SSM3K101TU	20	2.2	0.103	UFM	SSM3K122TU	20	2	0.123	UFM
SSM3K102TU	20	2.6	0.071	UFM	SSM3K119TU	30	2.5	0.074	UFM
SSM3K104TU	20	3	0.056	UFM	SSM3K121TU	20	3.2	0.048	UFM
SSM3K105TU	30	2.1	0.20	UFM	SSM3K119TU	30	2.5	0.074	UFM
SSM3K107TU	20	1.5	0.410	UFM	SSM3K122TU	20	2	0.123	UFM
SSM3K126TU	30	3.9	0.043	UFM	SSM3K131TU	30	6	0.0415	UFM
SSM3K128TU	30	1.5	0.360	UFM	SSM3K116TU	30	2.2	0.100	UFM
SSM3K12T	30	3	0.175	TSM	SSM3K320T	30	4.2	0.077	TSM
SSM3K14T	30	4	0.039	TSM	SSM3K320T	30	4.2	0.05	TSM
SSM3K15FS	30	0.1	4	SSM	SSM3K15AFS	30	0.1	3.6	SSM
SSM3K15FV	30	0.1	4	VESM	SSM3K15AMFV	30	0.1	3.6	VESM
SSM3K15TE	30	0.1	7	TESM	SSM3K15AMFV	30	0.1	3.6	VESM
SSM3K16CT	20	0.1	15	CST3	SSM3K37CT	20	0.2	5.6	CST3
SSM3K16FS	20	0.1	15	SSM	SSM3K37FS	20	0.2	5.6	SSM

To Be Discontinued					Replacement Products				
Part Number	Electrical Characteristics			Package	Part Number	Electrical Characteristics			Package
	V _{DSS} (V)	I _D (A)	R _{DS(ON)} Max(Ω)			V _{DSS} (V)	I _D (A)	R _{DS(ON)} Max(Ω)	
SSM3K16FV	20	0.1	15	VESM	SSM3K37MFV	20	0.25	5.6	VESM
SSM3K16TE	20	0.1	15	TESM	SSM3K37MFV	20	0.25	5.6	VESM
SSM3K302T	30	3	0.071	TSM	SSM3K316T	30	4	0.065	TSM
SSM3K303T	30	2	0.12	TSM	SSM3K320T	30	4.2	0.077	TSM
SSM3K311T	30	4.6	0.043	TSM	SSM3K333R	30	6	0.042	SOT-23F
SSM3K315T	30	6	0.0415	TSM	SSM3K333R	30	6	0.042	SOT-23F
SSM3K320T	30	4.2	0.077	TSM	SSM3K335R	30	6	0.056	SOT-23F
SSM3K36FS	20	0.5	0.66	SSM	SSM3K43FS	20	0.5	0.66	SSM
SSM3K7002F	60	0.2	3.3	S-MINI	SSM3K7002BF	60	0.2	3.3	S-MINI
SSM3K7002FU	60	0.2	3.3	USM	SSM3K7002BFU	60	0.2	3.3	USM
SSM5G01TU	-30	-1	0.8	UFV	SSM5G11TU	-30	-1.4	0.403	UFV
SSM5G04TU	-12	-1	0.24	UFV	SSM5G02TU	-12	-1	0.16	UFV
SSM5H03TU	12	1.4	0.3	UFV	SSM5H08TU	20	1.5	0.16	UFV
SSM5H05TU	20	1.5	0.16	UFV	SSM5H08TU	20	1.5	0.16	UFV
SSM5H12TU	30	1.9	0.133	UFV	SSM5H16TU	30	1.9	0.133	UFV
SSM6E02TU	20	1.8	0.204	UF6	SSM6E03TU	20	1.8	0.335	UF6
SSM6G06FE	-20	-0.1	45	ES6	-	-	-	-	-
SSM6H06FE	20	0.1	15	ES6	-	-	-	-	-
SSM6J06FU	-20	-0.65	0.5	US6	SSM6J50TU	-20	-2.5	0.064	UF6
SSM6J07FU	-30	-0.8	0.8	US6	SSM6J50TU	-20	-2.5	0.064	UF6
SSM6J08FU	-20	-1.3	0.18	US6	SSM6J50TU	-20	-2.5	0.064	UF6
SSM6J205FE	-20	-0.8	0.234	ES6	SSM6J213FE	-20	-2.6	0.103	ES6
SSM6J206FE	-20	-2	0.13	ES6	SSM6J213FE	-20	-2.6	0.103	ES6
SSM6J21TU	-12	-3	0.05	UF6	SSM6J412TU	-20	-4	0.043	UF6
SSM6J23FE	-12	-1.2	0.16	ES6	SSM6J213FE	-20	-2.6	0.103	ES6
SSM6J25FE	-20	-0.5	0.26	ES6	SSM6J213FE	-20	-2.6	0.103	ES6
SSM6J26FE	-20	-0.5	0.23	ES6	SSM6J213FE	-20	-2.6	0.103	ES6
SSM6J51TU	-12	-4	0.054	UF6	SSM6J412TU	-20	-4	0.043	UF6
SSM6J53FE	-20	-1.8	0.136	ES6	SSM6J213FE	-20	-2.6	0.103	ES6
SSM6K06FU	20	1.1	0.16	US6	SSM6K405TU	20	2	0.126	UF6
SSM6K07FU	30	1.5	0.13	US6	SSM6K34TU	30	3	0.05	UF6
SSM6K08FU	20	1.6	0.105	US6	SSM6K405TU	20	2	0.126	UF6
SSM6K18TU	20	4	0.04	UF6	SSM6K403TU	20	4.2	0.028	UF6
SSM6K203FE	20	2.8	0.0610	ES6	SSM6K211FE	20	3.2	0.0470	ES6
SSM6K22FE	20	1.4	0.17	ES6	SSM6K24FE	30	0.5	0.145	ES6
SSM6K25FE	20	0.5	0.145	ES6	SSM6K204FE	20	2	0.126	ES6
SSM6K31FE	20	1.2	0.54	ES6	SSM6K30FE	20	1.2	0.42	ES6
SSM6K32TU	60	2	0.3	UF6	SSM6K407TU	60	2	0.3	UF6
SSM6K34TU	30	3	0.077	UF6	SSM6K406TU	30	4.4	0.039	UF6
SSM6L05FU	-20	-0.2	3.3	US6	SSM6L36TU	-20	-0.33	1.31	UF6
SSM6L10TU	-20	-0.5	0.23	UF6	SSM6L39TU	-20	-1.5	0.294	UF6
SSM6L11TU	-20	-0.5	0.26	UF6	SSM6L39TU	-20	-1.5	0.294	UF6
SSM6L13TU	-20	-0.8	0.234	UF6	SSM6L39TU	-20	-1.5	0.294	UF6
SSM6L16FE	-20	-0.1	8	ES6	SSM6L35FE	-20	-0.1	8	ES6
SSM6N05FU	20	0.4	0.8	US6	SSM6N43FU	20	0.5	0.66	US6
SSM6N15FE	30	0.1	4	ES6	SSM6N15AFE	30	0.1	3.6	ES6
SSM6N15FU	30	0.1	4	US6	SSM6N15AFU	30	0.1	3.6	US6
SSM6N16FE	20	0.1	15	ES6	SSM6N37FE	20	0.25	5.6	ES6
SSM6N16FU	20	0.1	15	US6	SSM6N37FU	20	0.25	5.6	US6
SSM6N25TU	20	0.5	0.145	UF6	SSM6N39TU	20	1.6	0.119	UF6
SSM6N29TU	20	0.8	0.143	UF6	SSM6N39TU	20	1.6	0.119	UF6
SSM6N36TU	20	0.5	0.66	UF6	SSM6N43FU	20	0.5	0.66	US6
SSM6N7002FU	60	0.2	3.3	US6	SSM6N7002BFU	60	0.2	3.3	US6
SSM6P05FU	-20	-0.2	3.3	US6	SSM6P36TU	-20	-0.33	1.31	UF6
SSM6P16FE	-20	-0.1	8	ES6	SSM6P35FE	-20	-0.1	8	ES6
SSM6P16FU	-20	-0.1	8	US6	SSM6P35FU	-20	-0.1	8	US6
SSM6P25TU	-20	-0.5	0.26	UF6	SSM6P39TU	-20	-1.5	0.213	UF6
SSM6P26TU	-20	-0.5	0.23	UF6	SSM6P39TU	-20	-1.5	0.213	UF6
SSM6P28TU	-20	-0.8	0.234	UF6	SSM6P39TU	-20	-1.5	0.213	UF6
TK12D60U	600	12	0.4	TO-220(W)	TK12E60U	600	12	0.4	TO-220
TK15D60U	600	15	0.3	TO-220(W)	TK15E60U	600	15	0.3	TO-220

To Be Discontinued					Replacement Products				
Part Number	Electrical Characteristics			Package	Part Number	Electrical Characteristics			Package
	V _{DSS} (V)	I _D (A)	R _{DS(ON)} Max(Ω)			V _{DSS} (V)	I _D (A)	R _{DS(ON)} Max(Ω)	
TK20D60T	600	20	0.19	TO-220(W)	TK20E60U	600	20	0.19	TO-220
TK20D60U	600	20	0.19	TO-220(W)	TK20E60U	600	20	0.19	TO-220
TK40A10J1	100	40	0.015	TO-220SIS	TK40A10K3	100	40	0.015	TO-220SIS
TPC6103	-12	-6	0.035	VS-6	TPC6111	-12	-5.5	0.04	VS-6
TPC8027	30	18	0.0027	SOP-8	TPC8080	30	18	0.0028	SOP-8
TPC8028	30	18	0.0043	SOP-8	TPC8073	30	18	0.0047	SOP-8
TPC8029	30	18	0.0038	SOP-8	TPC8082	30	18	0.004	SOP-8
TPC8035-H	30	18	0.0032	SOP-8	TPC8057-H	30	18	0.0028	SOP-8
TPC8036-H	30	18	0.0045	SOP-8	TPC8059-H	30	18	0.004	SOP-8
TPC8037-H	30	12	0.0114	SOP-8	TPC8065-H	30	13	0.0121	SOP-8
TPC8038-H	30	12	0.0114	SOP-8	TPC8065-H	30	13	0.0118	SOP-8
TPC8039-H	30	17	0.006	SOP-8	TPC8062-H	30	18	0.0058	SOP-8
TPC8040-H	30	13	0.0097	SOP-8	TPC8064-H	30	16	0.0084	SOP-8
TPC8041	30	13	0.007	SOP-8	TPC8074	30	17	0.0065	SOP-8
TPC8042	30	13	0.0034	SOP-8	TPC8081	30	13	0.0031	SOP-8
TPC8060-H	30	18	0.0037	SOP-8	TPC8058-H	30	18	0.0032	SOP-8
TPC8061-H	30	8	0.026	SOP-8	TPC8067-H	30	9	0.025	SOP-8
TPC8117	-30	-18	0.0039	SOP-8	TPC8120	-30	-18	0.0032	SOP-8
TPC8118	-30	-13	0.007	SOP-8	TPC8127	-30	-13	0.0065	SOP-8
TPC8119	-30	-10	0.013	SOP-8	TPC8125	-30	-10	0.013	SOP-8
TPC8121	-30	-11	0.012	SOP-8	TPC8125	-30	-10	0.013	SOP-8
TPC8122	-30	-11	0.008	SOP-8	TPC8127	-30	-13	0.0065	SOP-8
TPC8221-H	30	6	0.025	SOP-8	TPC8224-H	30	9	0.026	SOP-8
TPC8A03-H	30	17	0.0056	SOP-8	-	-	-	-	-
TPC8A04-H	30	18	0.0036	SOP-8	-	-	-	-	-
TPC8A05-H	30	10	0.0133	SOP-8	-	-	-	-	-
TPC8A06-H	30	12	0.0101	SOP-8	-	-	-	-	-
TPCA8020-H	40	7.5	0.027	SOP Advance	TPCA8052-H	40	7.5	0.0113	SOP Advance
TPCA8024	30	35	0.0043	SOP Advance	TPCA8082	30	32	0.0038	SOP Advance
TPCA8025	30	40	0.0035	SOP Advance	TPCA8082	30	32	0.0038	SOP Advance
TPCA8026	30	45	0.0022	SOP Advance	TPCA8088	30	48	0.0022	SOP Advance
TPCA8027-H	40	30	0.01	SOP Advance	TPCA8047-H	40	32	0.0073	SOP Advance
TPCA8028-H	30	50	0.0028	SOP Advance	TPCA8057-H	30	42	0.0026	SOP Advance
TPCA8030-H	30	24	0.011	SOP Advance	TPCA8065-H	30	13	0.012	SOP Advance
TPCA8031-H	30	24	0.011	SOP Advance	TPCA8065-H	30	13	0.012	SOP Advance
TPCA8036-H	30	38	0.0042	SOP Advance	TPCA8059-H	30	32	0.0032	SOP Advance
TPCA8039-H	30	34	0.0057	SOP Advance	TPCA8062-H	30	28	0.0056	SOP Advance
TPCA8040-H	30	23	0.0094	SOP Advance	TPCA8064-H	30	20	0.0082	SOP Advance
TPCA8042	30	45	0.0033	SOP Advance	TPCA8081	30	38	0.003	SOP Advance
TPCA8060-H	30	45	0.0034	SOP Advance	TPCA8058-H	30	45	0.003	SOP Advance
TPCA8104	-60	-40	0.016	SOP Advance	TJ50S06M3L	-60	-50	0.0138	DPAK+
TPCA8105	-12	-6	0.033	SOP Advance	TPCC8136	-20	-9.4	0.016	TSON Advance
TPCA8106	-30	-40	0.0037	SOP Advance	TPCA8128	-30	-40	0.0048	SOP Advance
TPCA8107-H	-40	-7.5	0.03	SOP Advance	-	-	-	-	-
TPCA8108	-40	-40	0.0095	SOP Advance	TPC8124	-40	-12	0.008	SOP-8
TPCA8A02-H	30	34	0.0053	SOP Advance	TPCA8A11-H	30	35	0.0036	SOP Advance
TPCA8A04-H	30	44	0.0032	SOP Advance	TPCA8A10-H	30	44	0.0033	SOP Advance
TPCA8A05-H	30	20	0.0129	SOP Advance	-	-	-	-	-
TPCA8A08-H	30	38	0.0042	SOP Advance	TPCA8A11-H	30	35	0.0036	SOP Advance
TPCC8001-H	30	22	0.0083	TSON Advance	TPCC8064-H	30	19	0.0082	TSON Advance
TPCC8002-H	30	22	0.0083	TSON Advance	TPCC8064-H	30	19	0.0082	TSON Advance
TPCC8003-H	30	13	0.0169	TSON Advance	TPCC8062-H	30	27	0.0056	TSON Advance
TPCC8005-H	30	26	0.0064	TSON Advance	TPCC8062-H	30	27	0.0056	TSON Advance
TPCC8006-H	30	22	0.008	TSON Advance	TPCC8062-H	30	27	0.0056	TSON Advance
TPCC8008	30	25	0.0068	TSON Advance	TPCC8073	30	27	0.0045	TSON Advance
TPCC8009	30	24	0.007	TSON Advance	TPCC8084	33	21	0.0067	TSON Advance
TPCC8061-H	30	8	0.026	TSON Advance	TPCC8067-H	30	9	0.025	TSON Advance
TPCC8102	-30	-15	0.0189	TSON Advance	TPCC8131	-30	-10	0.0176	TSON Advance
TPCC8A01-H	30	21	0.0099	TSON Advance	-	-	-	-	-
TPCF8002	30	7	0.0021	VS-8	TPCF8004	30	7	0.024	VS-8
TPCF8101	-12	-6	0.028	VS-8	TPCF8105	-20	-6	0.03	VS-8

To Be Discontinued				Replacement Products					
Part Number	Electrical Characteristics			Package	Part Number	Electrical Characteristics			Package
	V _{DSS} (V)	I _D (A)	R _{DS(ON)} Max(Ω)			V _{DSS} (V)	I _D (A)	R _{DS(ON)} Max(Ω)	
TPCF8104	-30	-6	0.028	VS-8	TPCF8107	-30	-6	0.028	VS-8
TPCF8302	-20	-3	0.059	VS-8	TPCF8305	-20	-4	0.058	VS-8
TPCP8003-H	100	2.2	0.18	PS-8	-	-	-	-	-
TPCP8005-H	30	11	0.0129	PS-8	TPCC8065-H	30	13	0.0114	TSON Advance
TPCP8008-H	30	8	0.02	PS-8	TPCC8066-H	30	11	0.015	TSON Advance
TPCP8102	-20	-7.2	0.018	PS-8	TPCP8105	-20	-5.2	0.017	VS-8
TPCP8103-H	-40	-4.8	0.04	PS-8	-	-	-	-	-
TPCP8403	-40/40	-3.4/4.7	0.07/0.04	PS-8	TPCP8406	-40/40	-5/6	0.0432/0.032	PS-8
TPCP8A05-H	30	8	0.0175	PS-8	-	-	-	-	-

9-1 Compact Surface-Mount Packages

Toshiba offers a broad range of packaging options suitable for various mobile applications, including ultra-small, thin packages; those specifically designed for lithium-ion battery protection circuits; high-current packages with a thermal fin on the bottom.

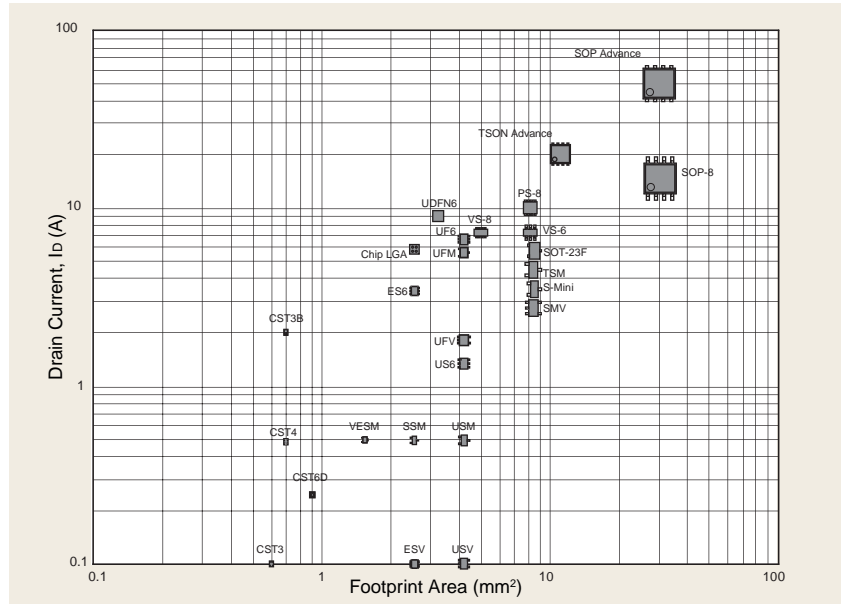

■ CST3

Unit: mm

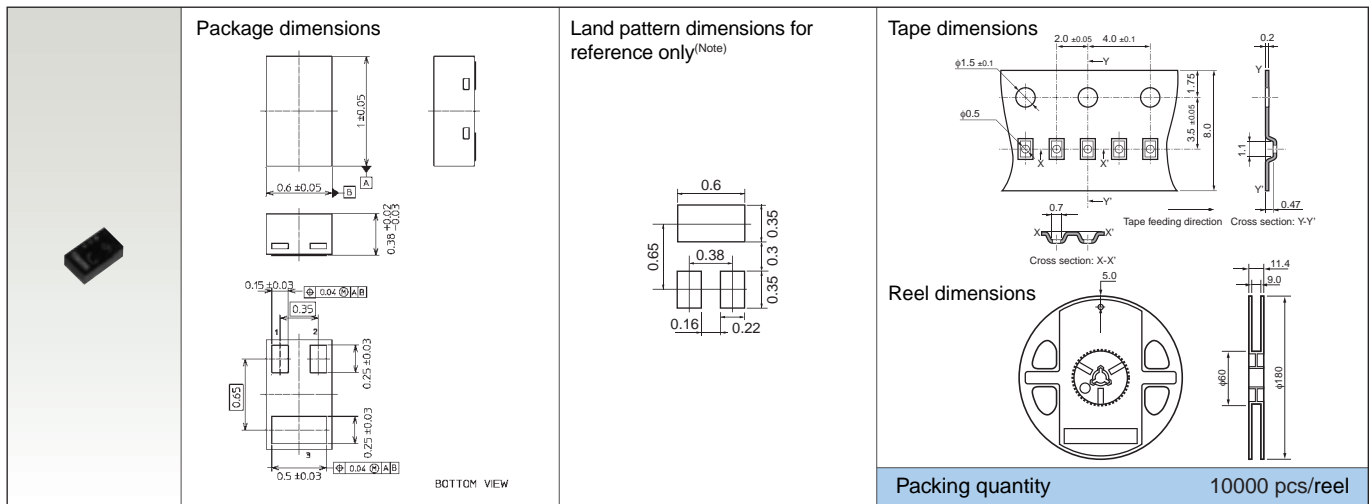

■ CST3B

Unit: mm

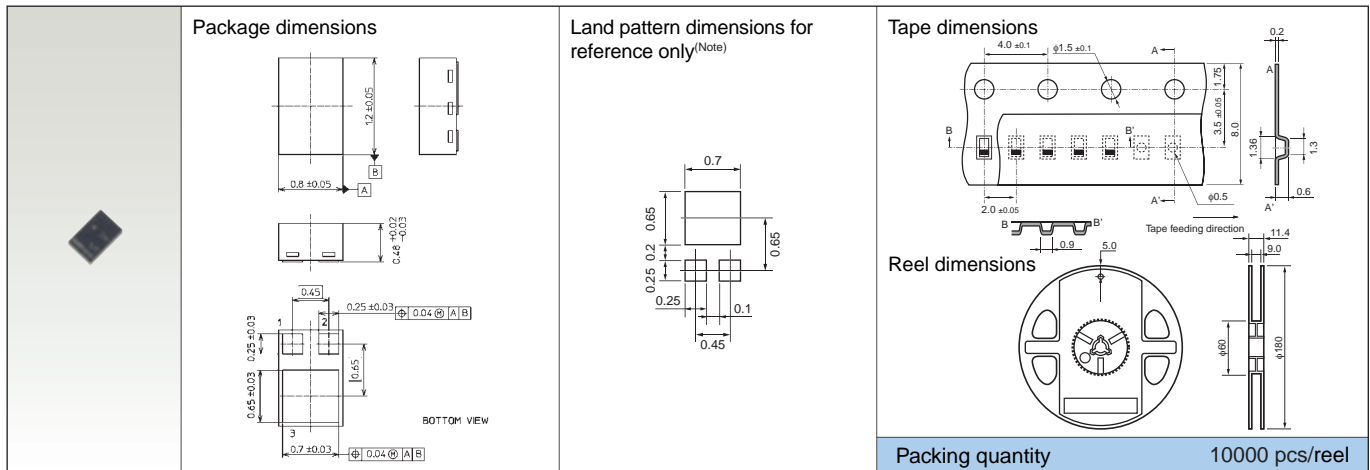

Note: For reference only. Land pattern dimensions should be determined empirically.

■ VESM (SOT-723)

Unit: mm

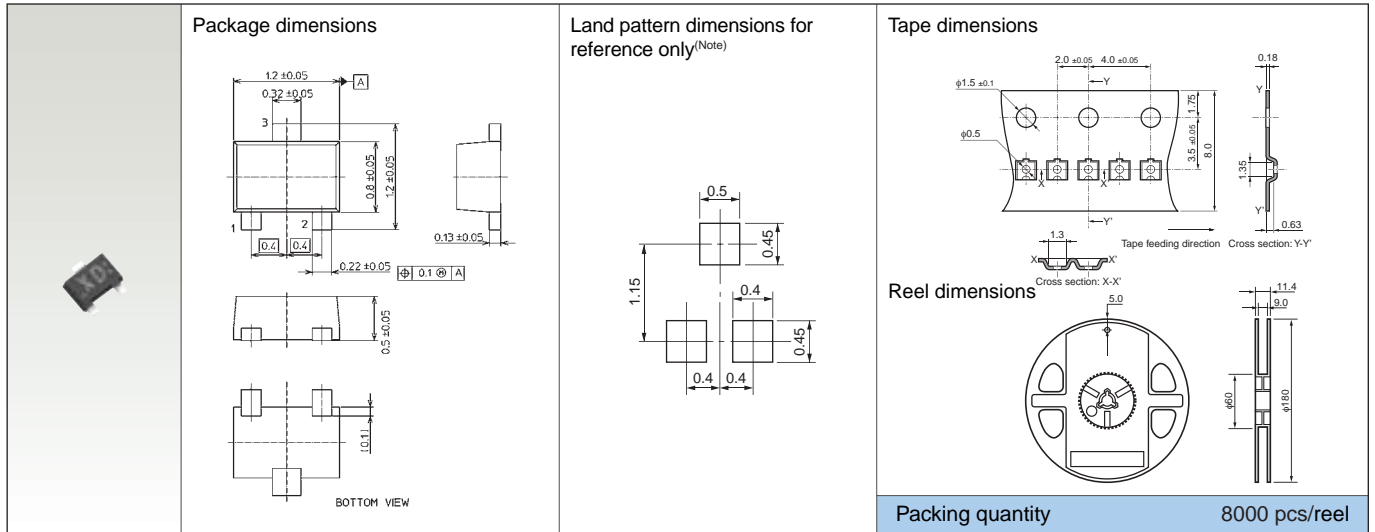

■ SSM (SOT-416)(SC-75)

Unit: mm

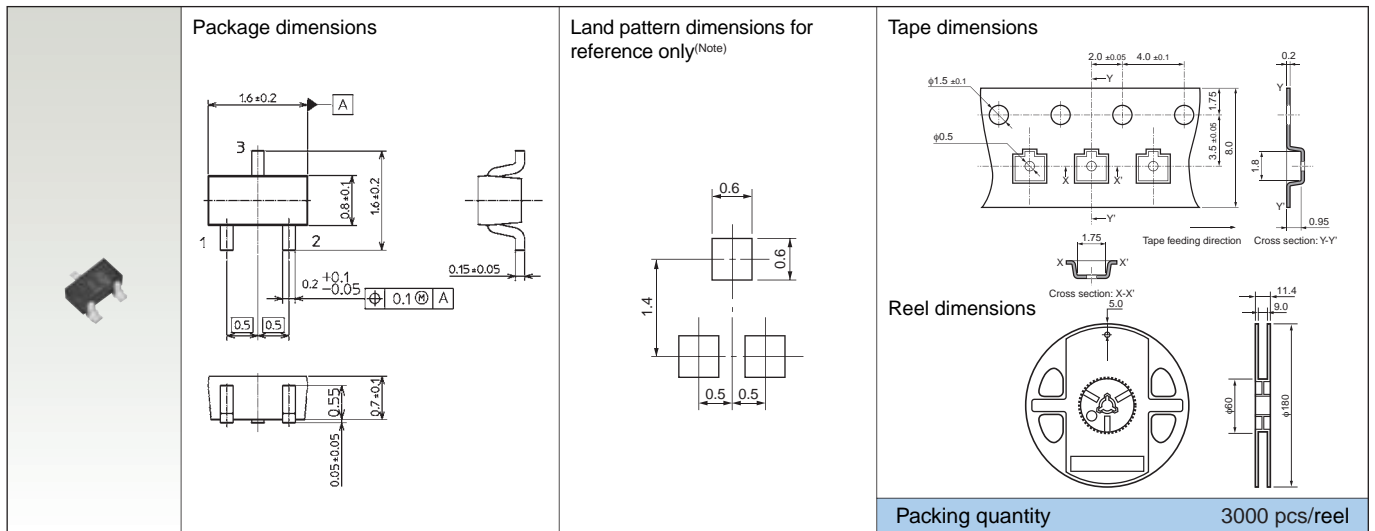

■ USM (SOT-323)(SC-70)

Unit: mm

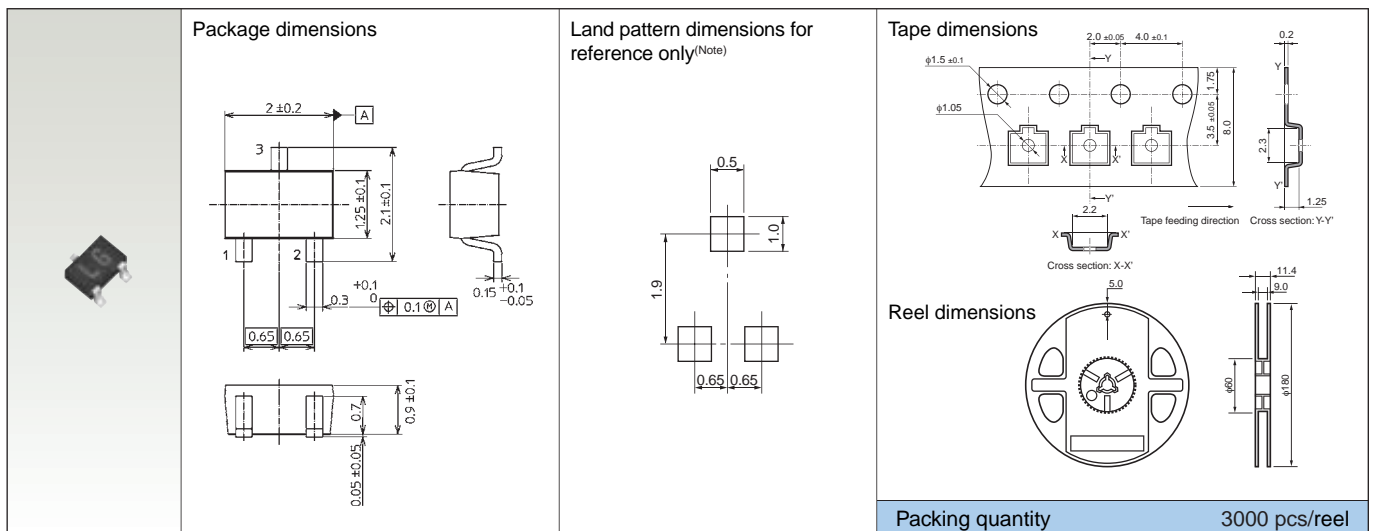

Note: For reference only. Land pattern dimensions should be determined empirically.

■ UFM

Unit: mm

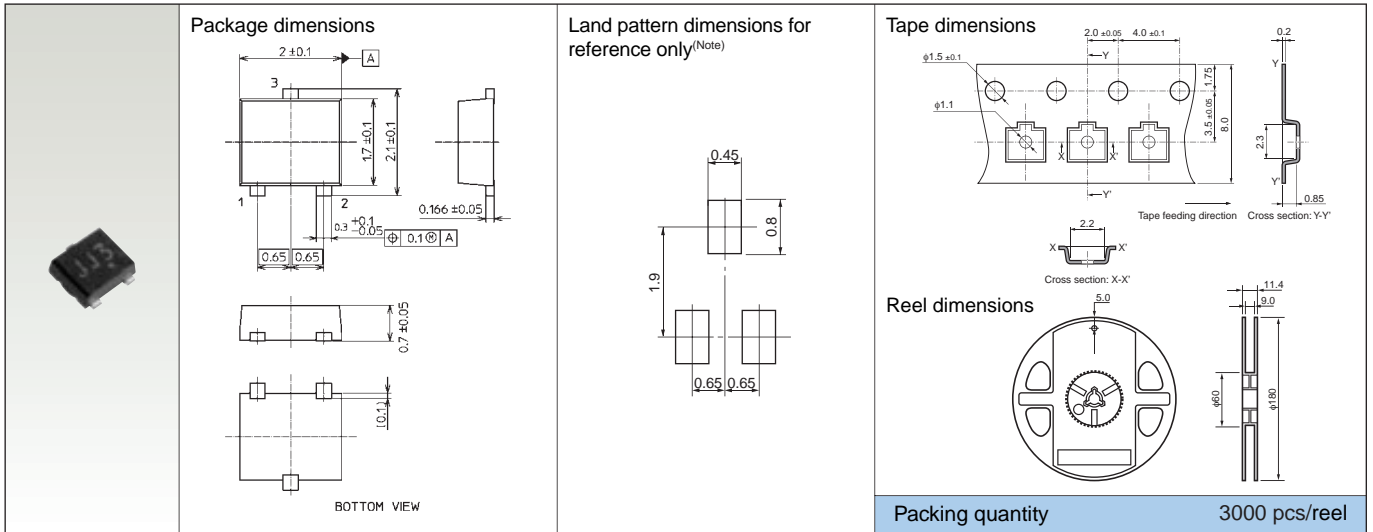

■ SOT-23F

Unit: mm

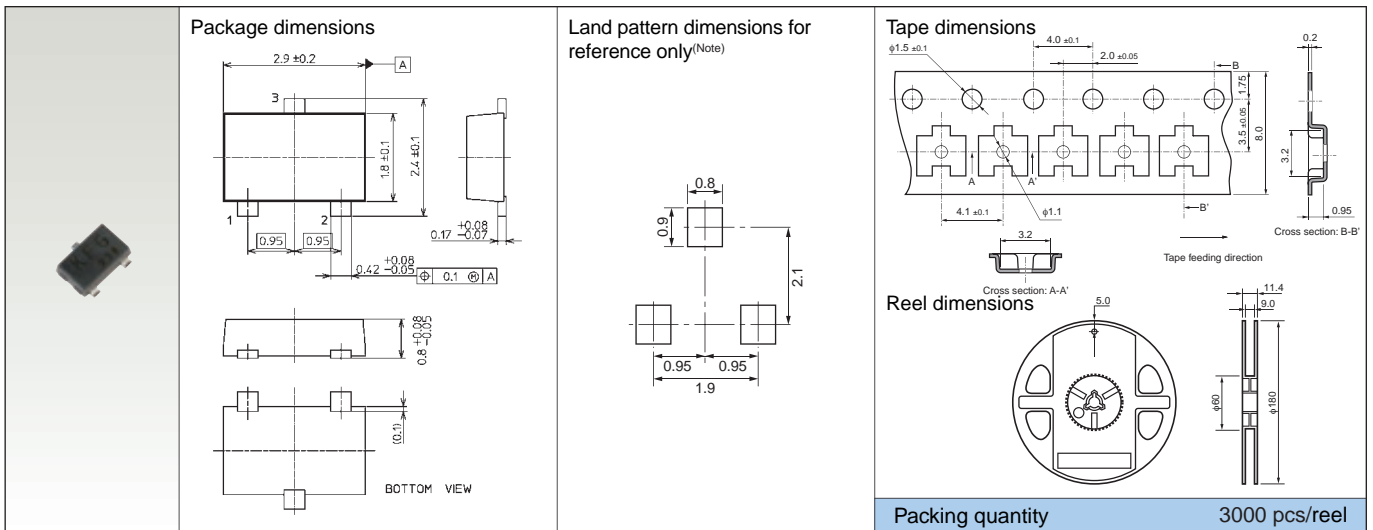

■ S-Mini (SOT-346)(SC-59)

Unit: mm

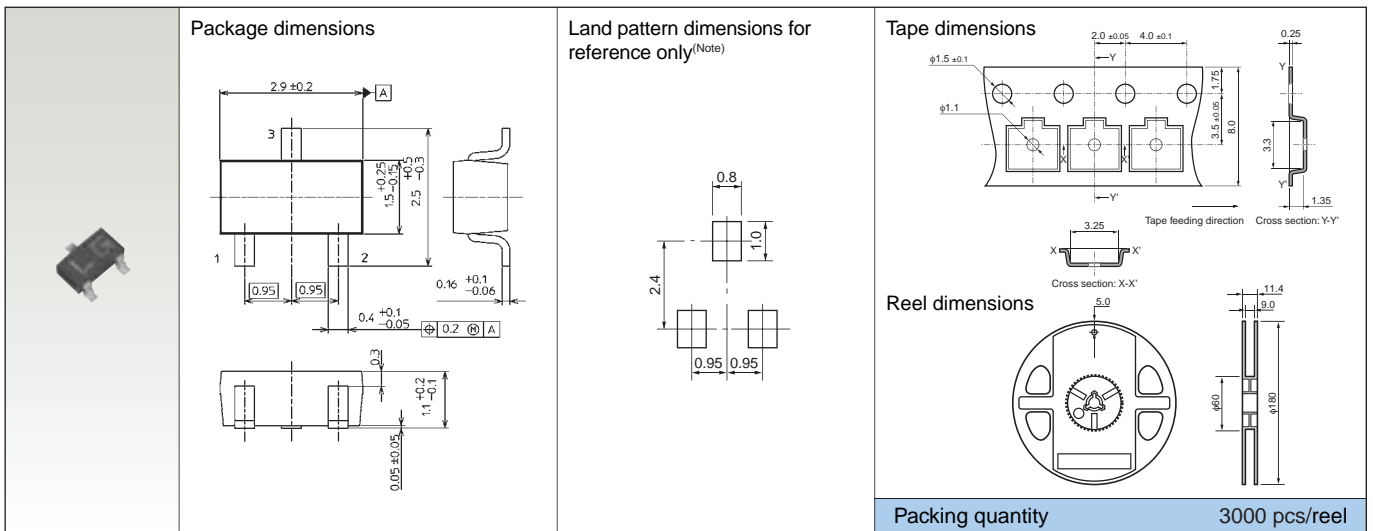

Note: For reference only. Land pattern dimensions should be determined empirically.

■ TSM

Unit: mm

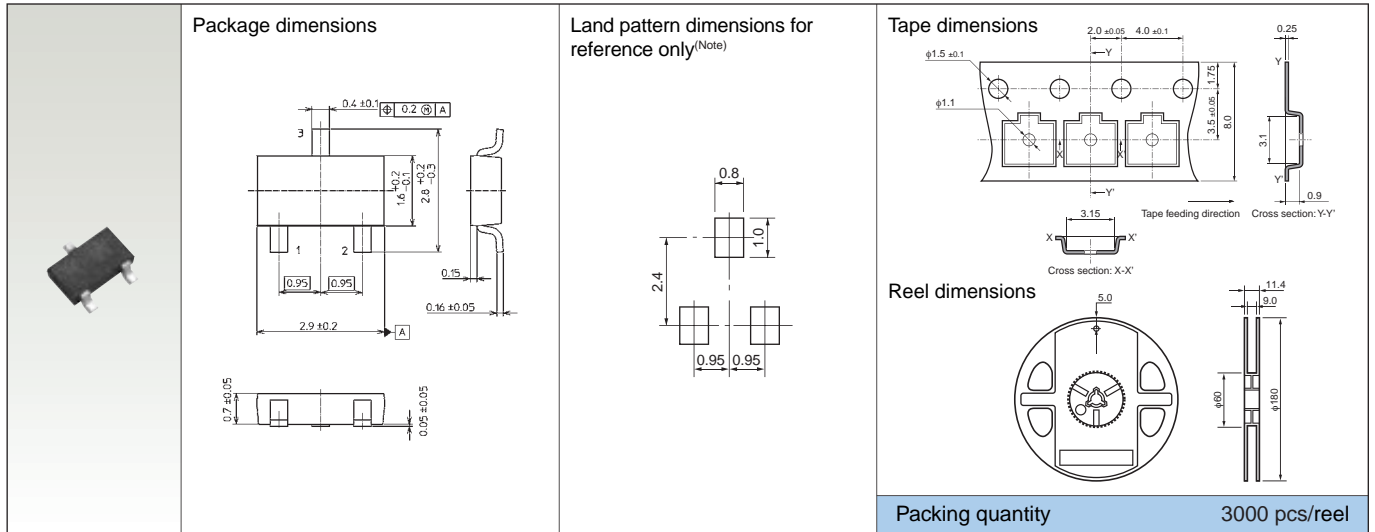

■ CST4

Unit: mm

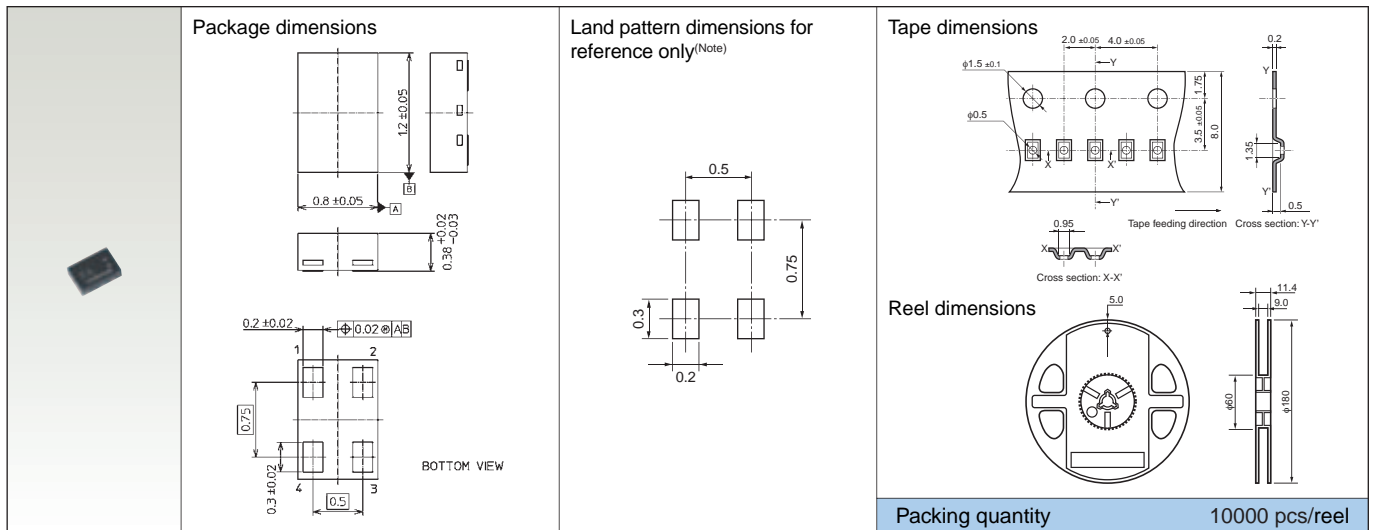

■ ESV (SOT-553)

Unit: mm

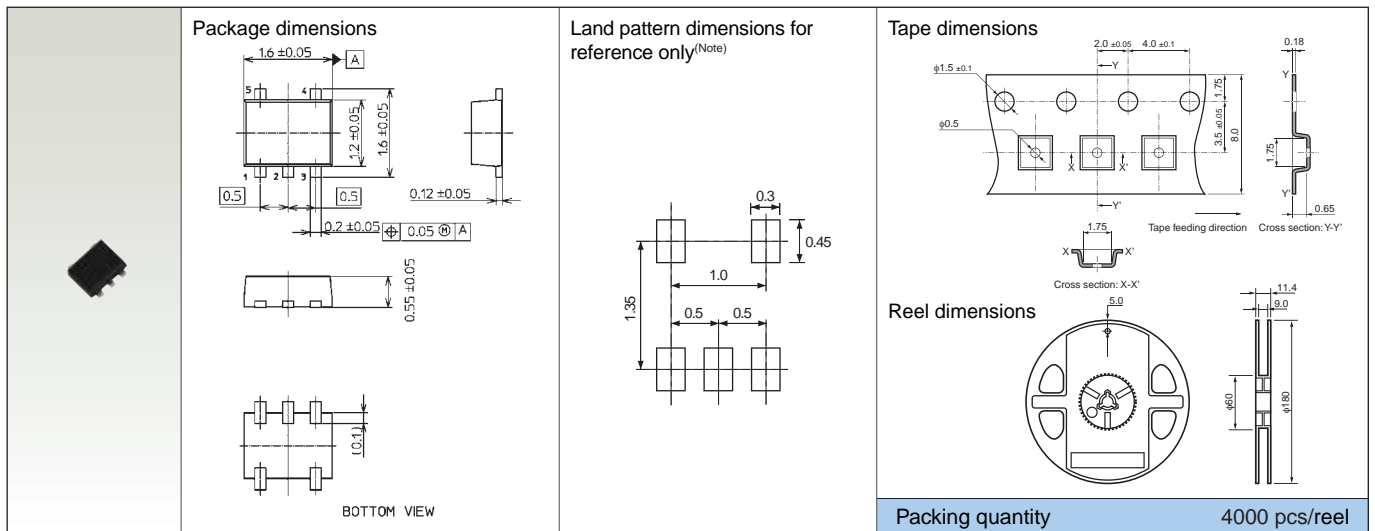

Note: For reference only. Land pattern dimensions should be determined empirically.

■ USV (SOT-353)(SC-88A)

Unit: mm

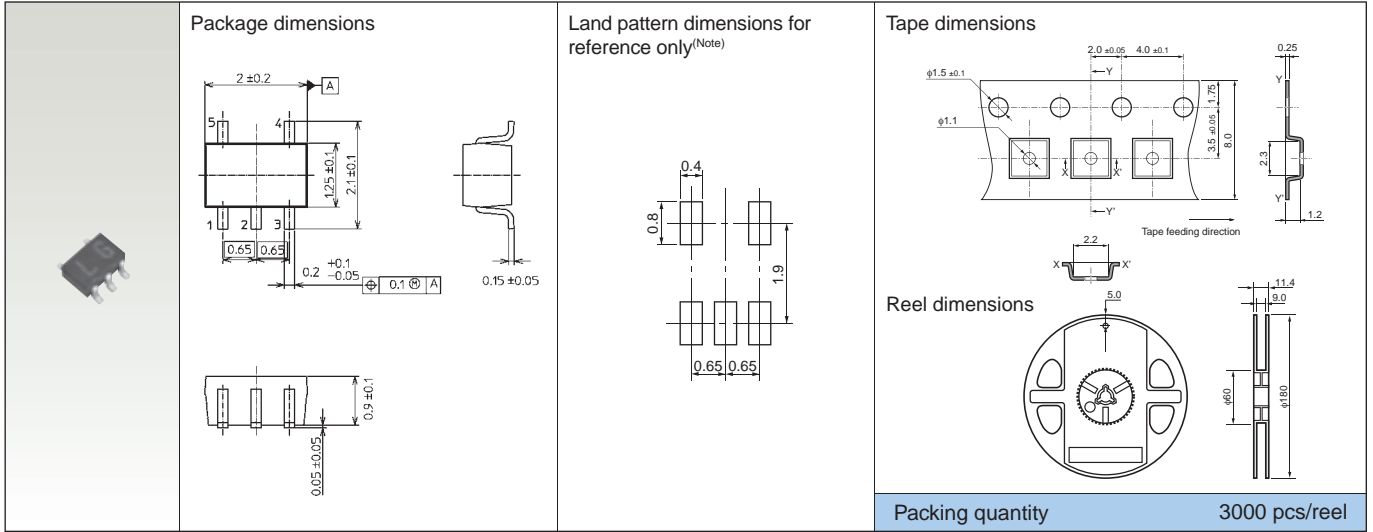

■ UFV

Unit: mm

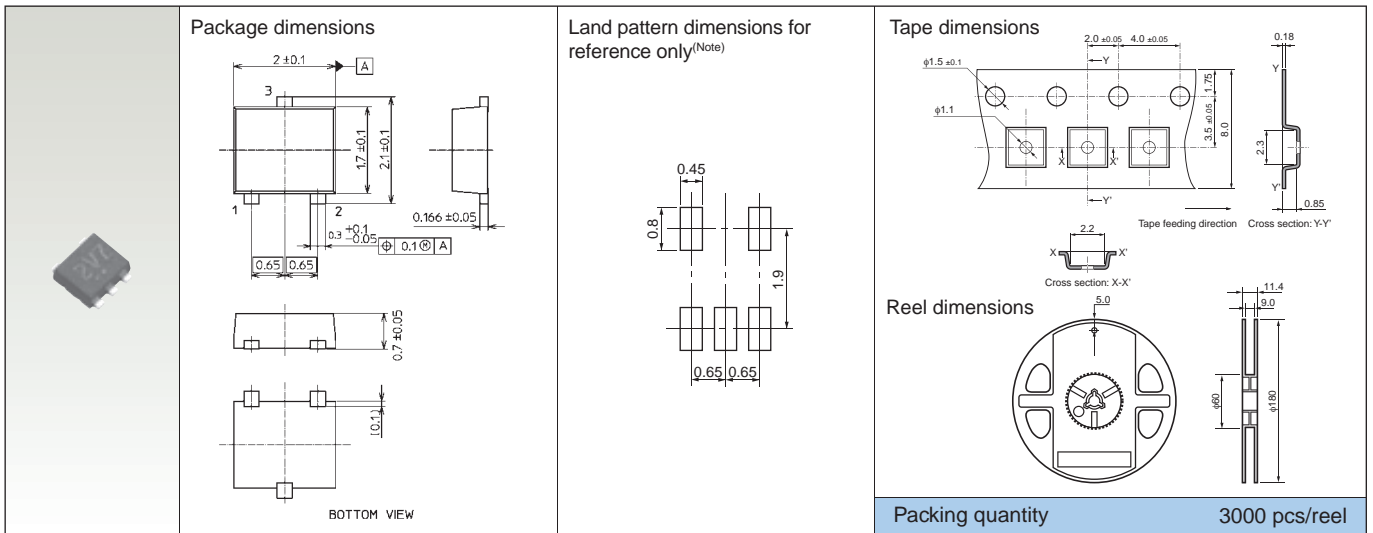

■ SMV (SOT-25)(SC-74A)

Unit: mm

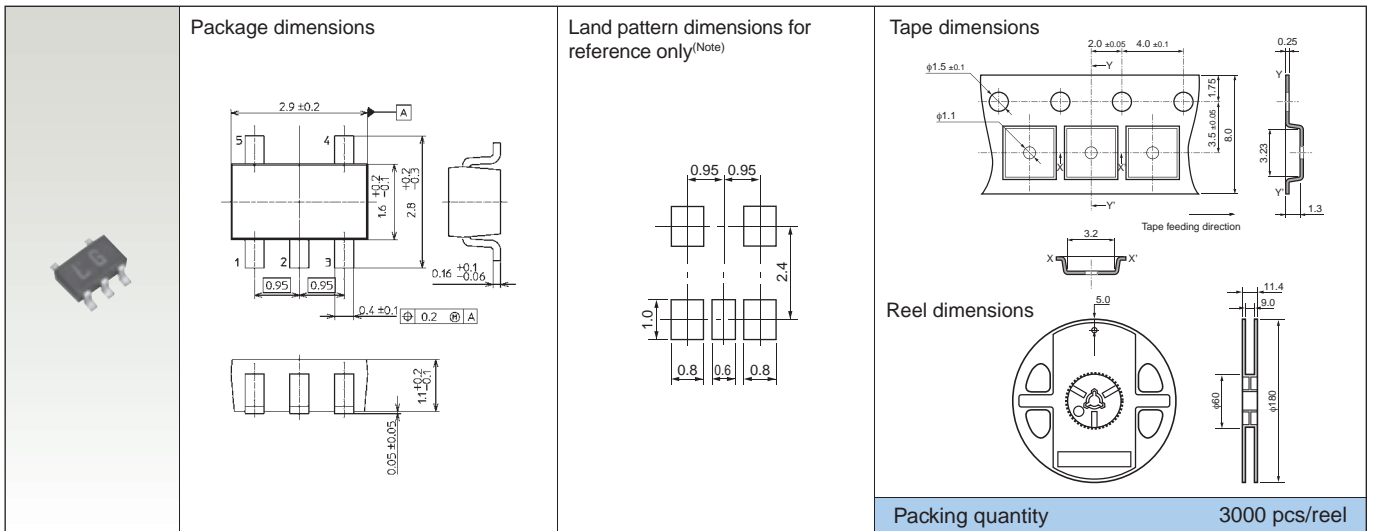

Note: For reference only. Land pattern dimensions should be determined empirically.

■ CST6D

Unit: mm

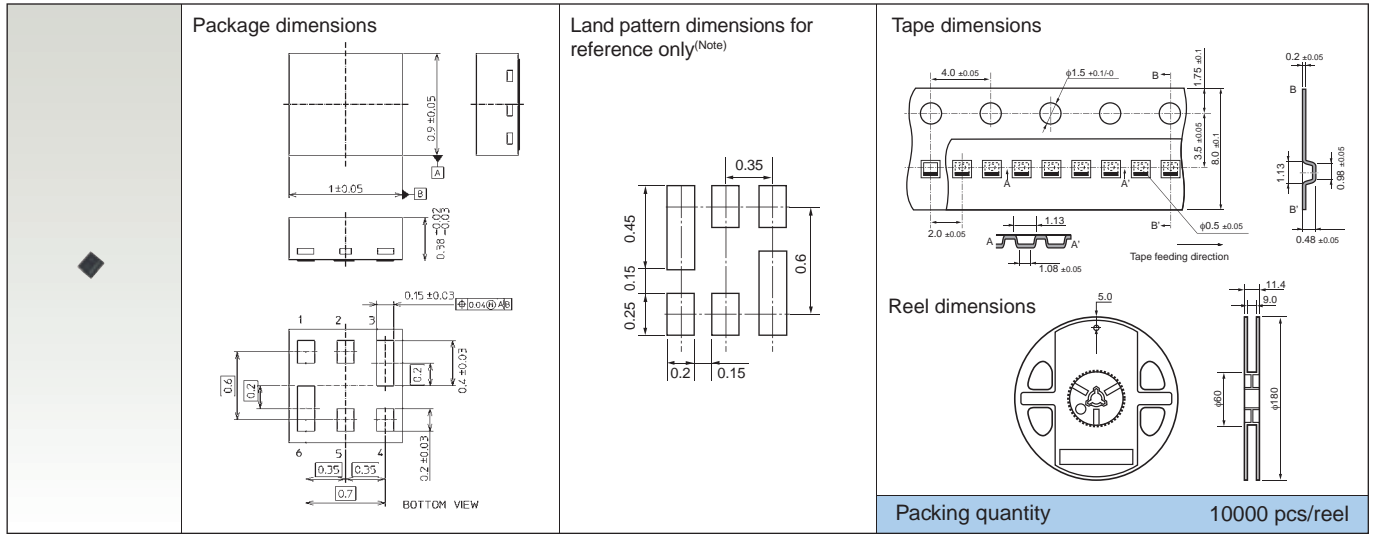

■ ES6 (SOT-563)

Unit: mm

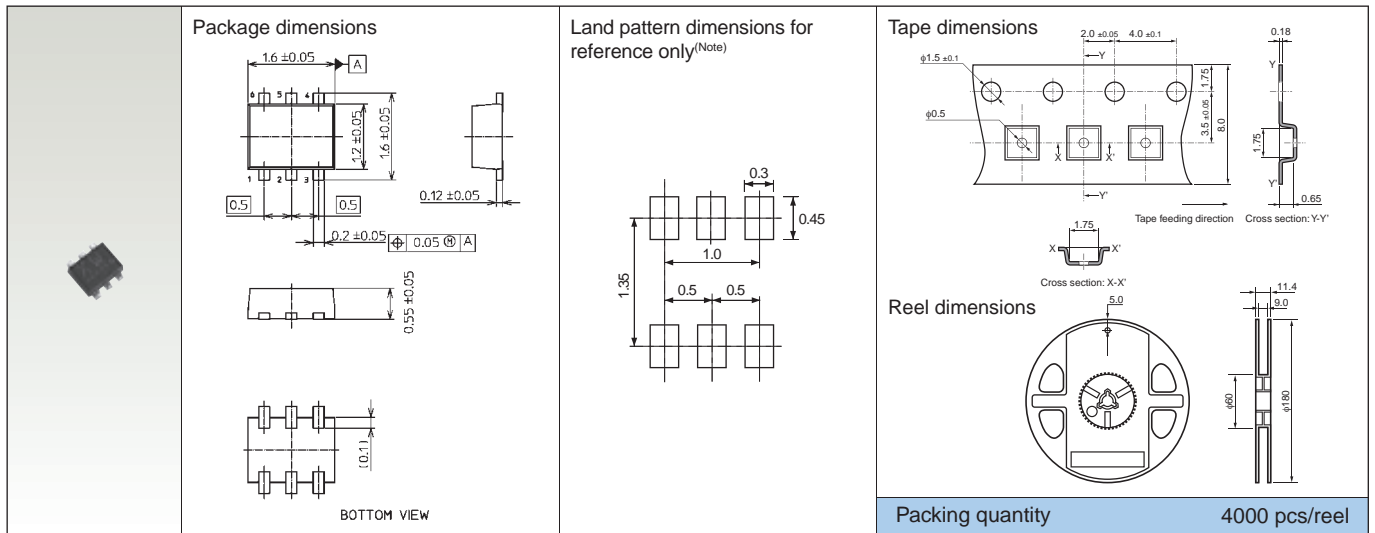

■ UDFN6B (1in1)

Unit: mm

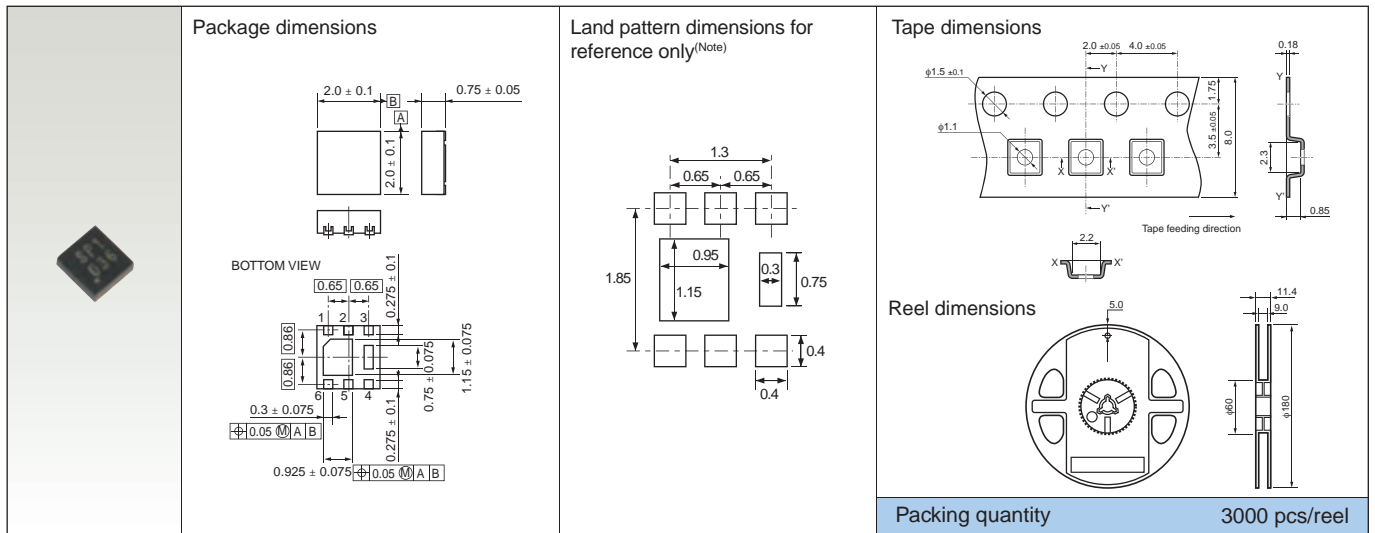

Note: For reference only. Land pattern dimensions should be determined empirically.

UDFN6 (2in1)

Unit: mm

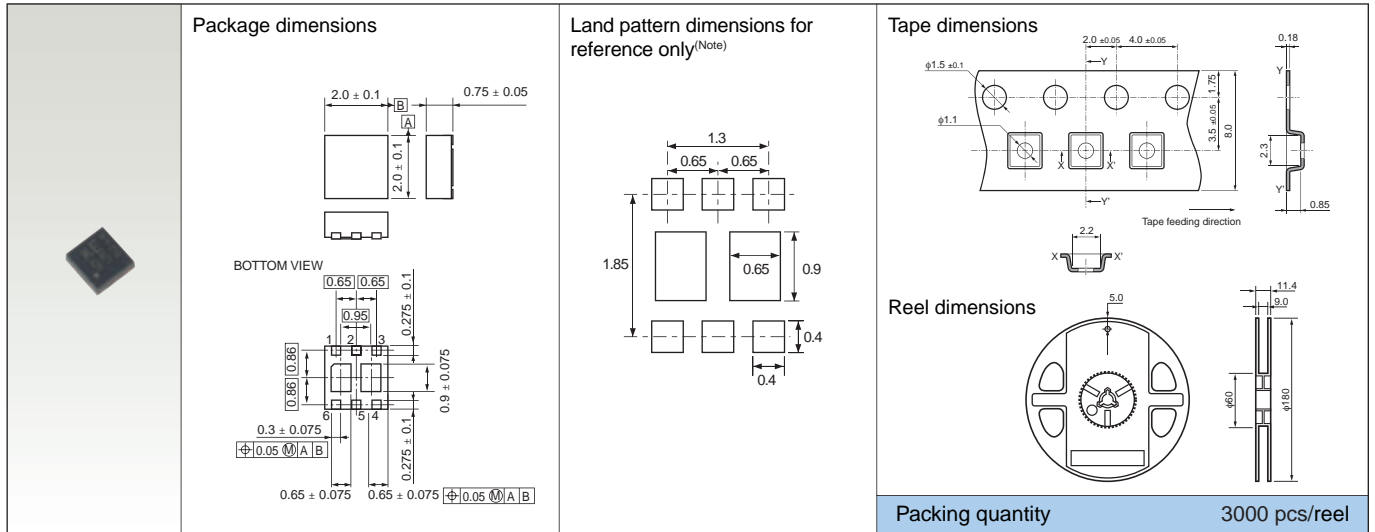

US6 (SOT-363)(SC-88)

Unit: mm

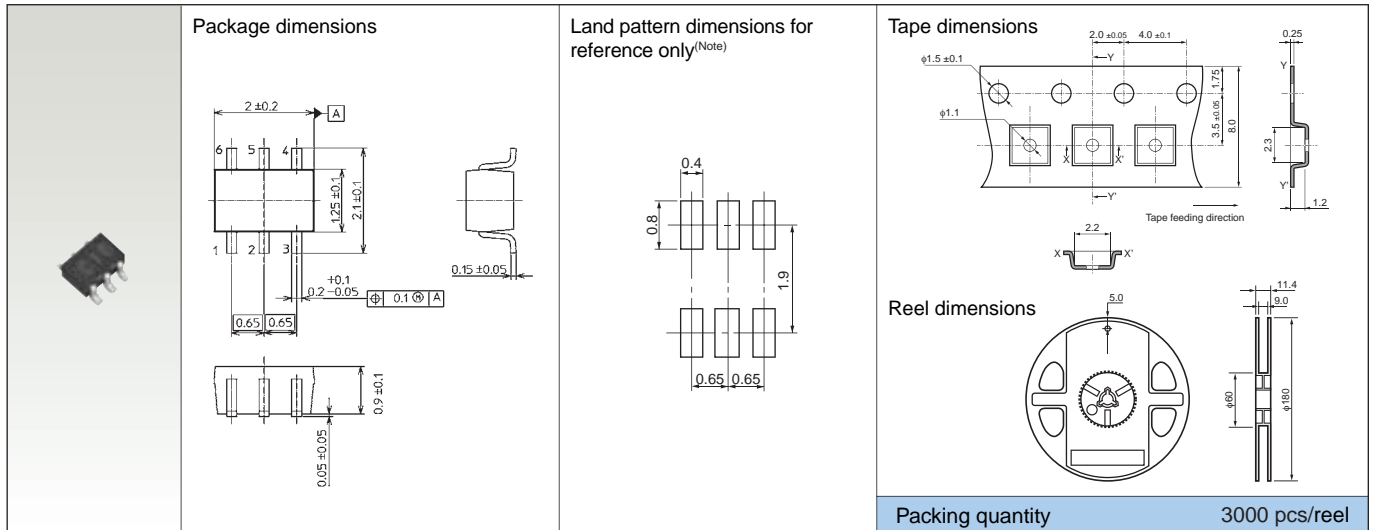

UF6

Unit: mm

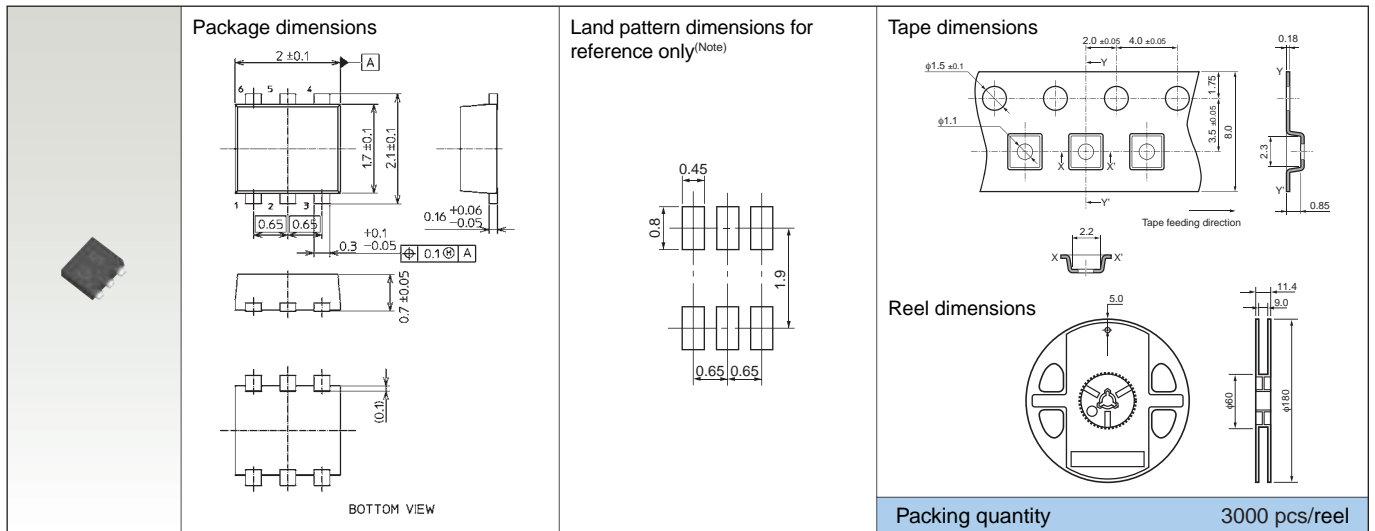

Note: For reference only. Land pattern dimensions should be determined empirically.

■ VS-6

Unit: mm

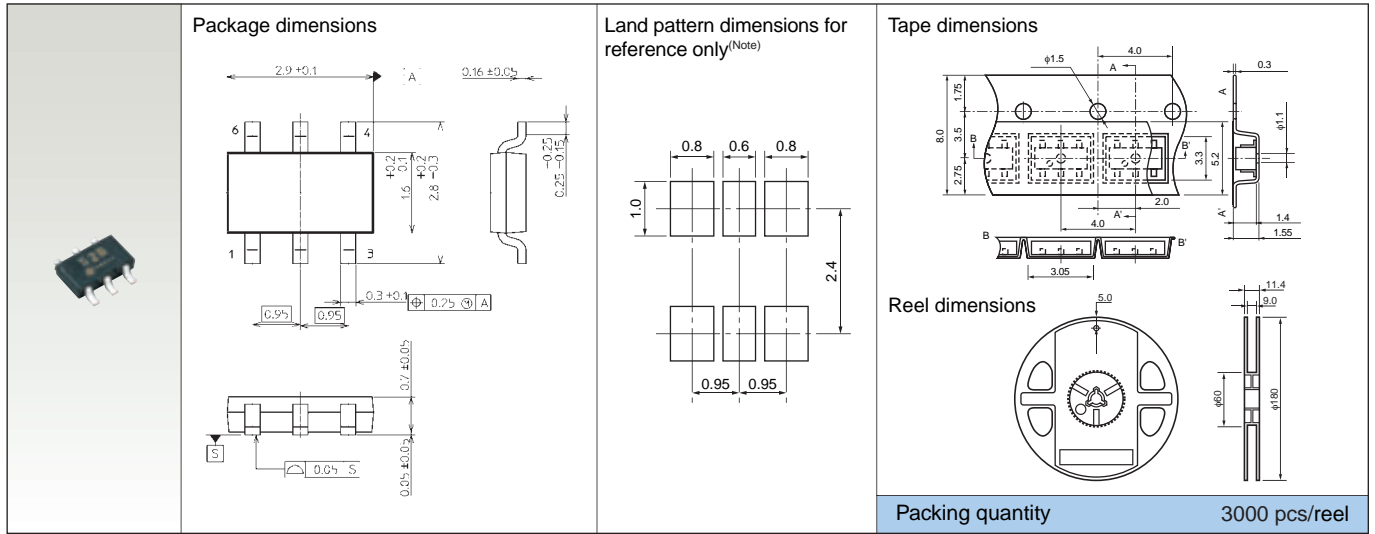

■ VS-8

Unit: mm

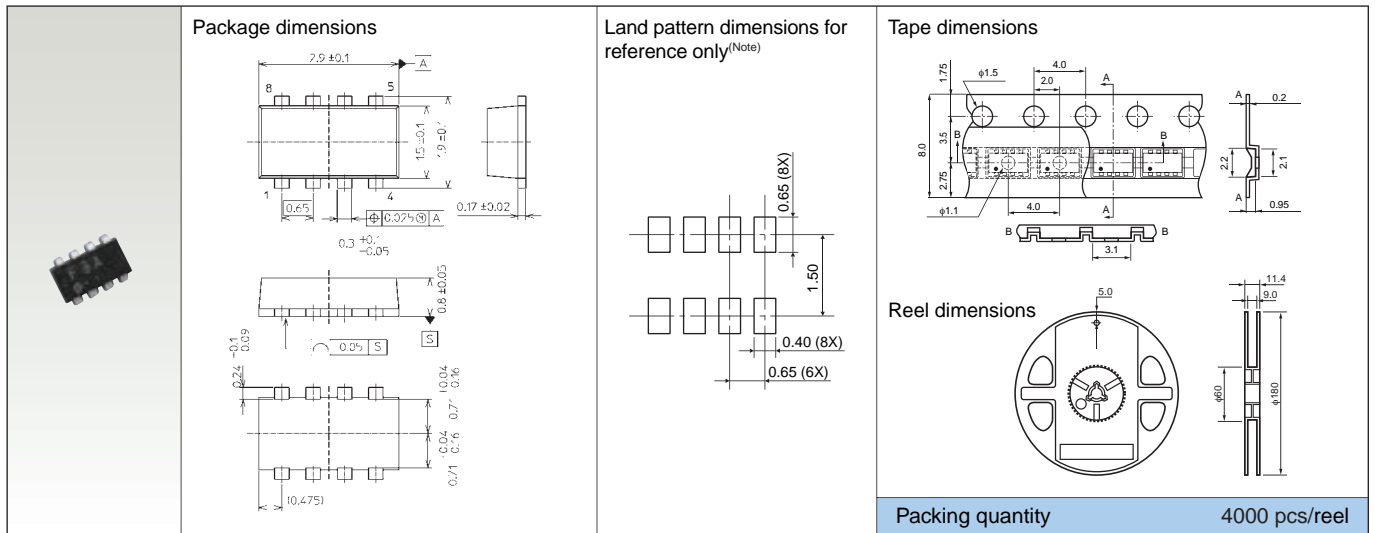

■ PS-8

Unit: mm

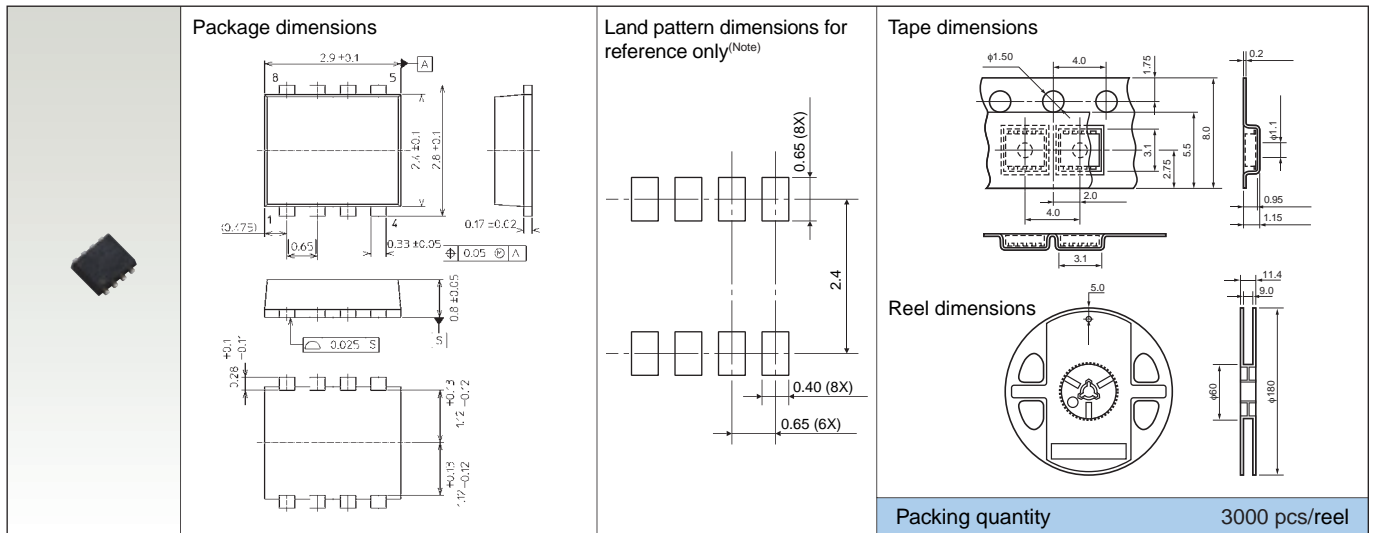

Note: For reference only. Land pattern dimensions should be determined empirically.

■ TSON Advance

Unit: mm

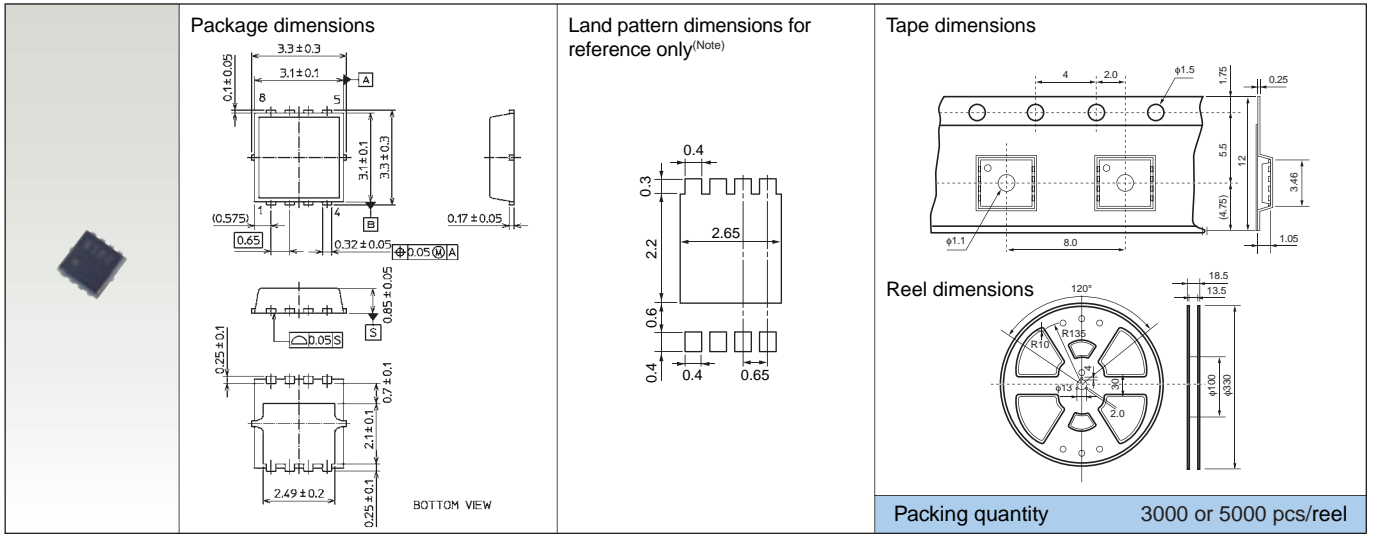

■ Chip LGA

Unit: mm

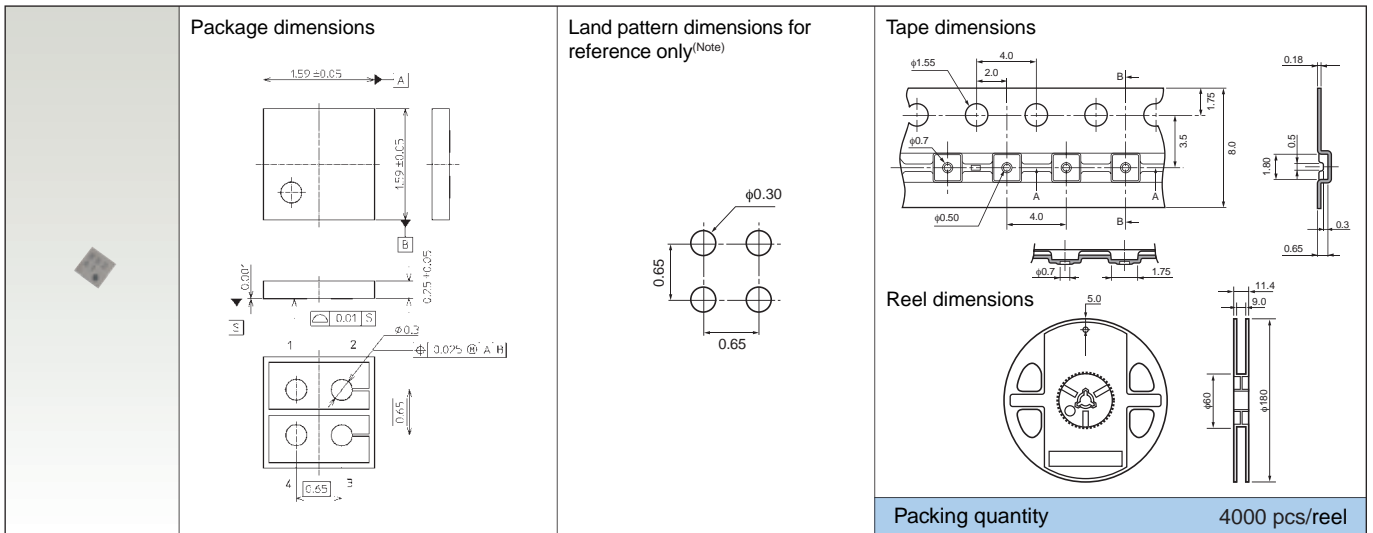

■ SOP-8

Unit: mm

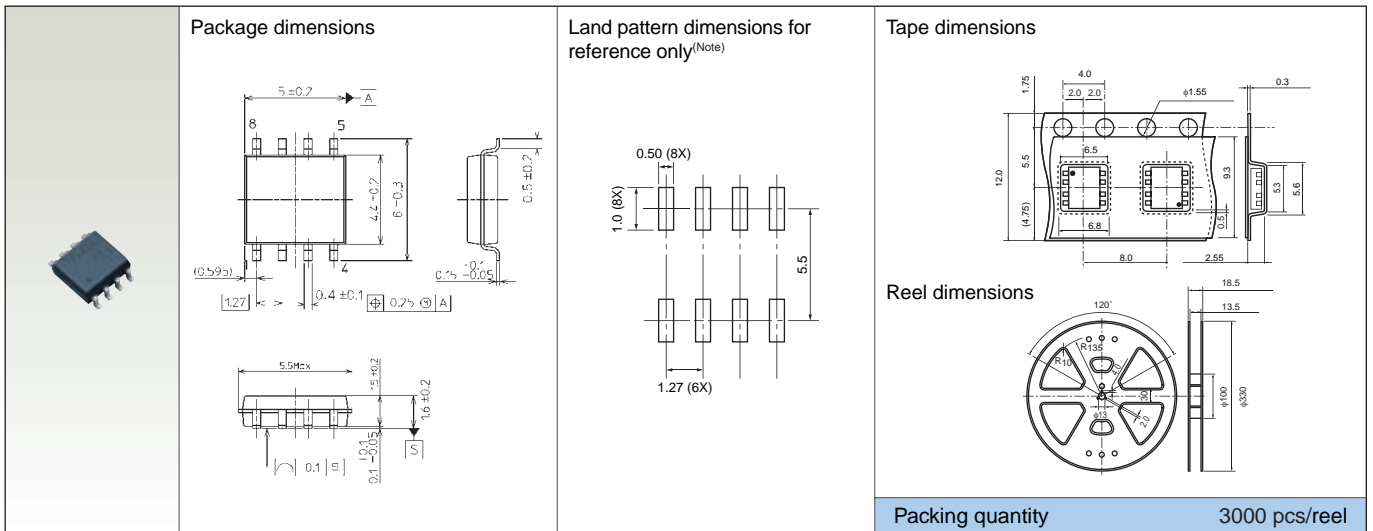

Note: For reference only. Land pattern dimensions should be determined empirically.

■ SOP Advance

Unit: mm

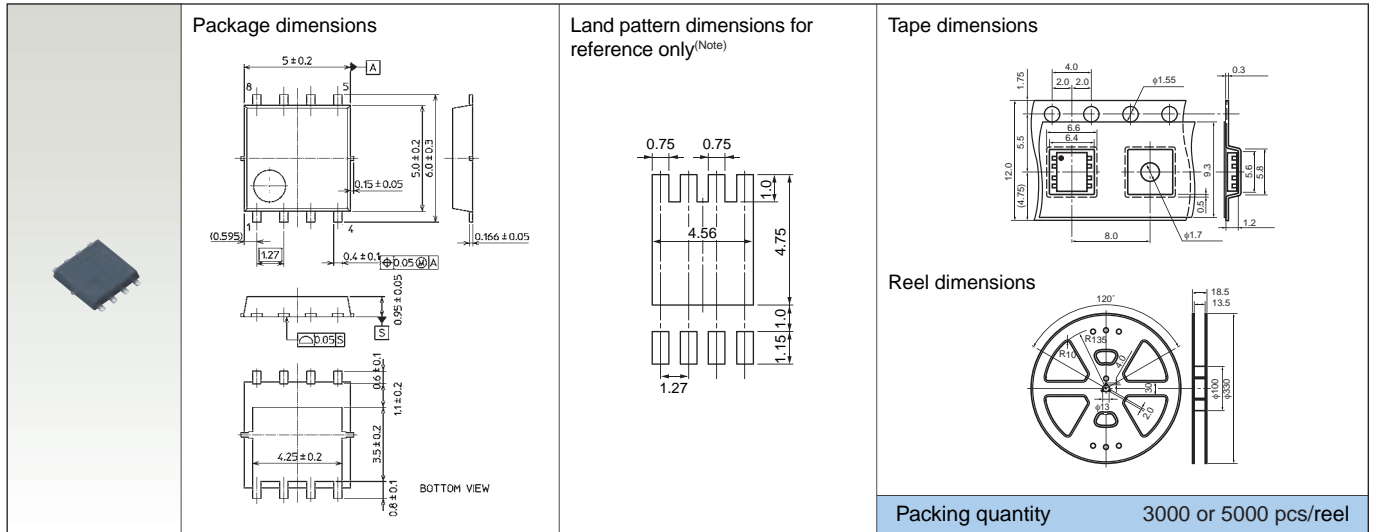

■ PW-Mini

Unit: mm

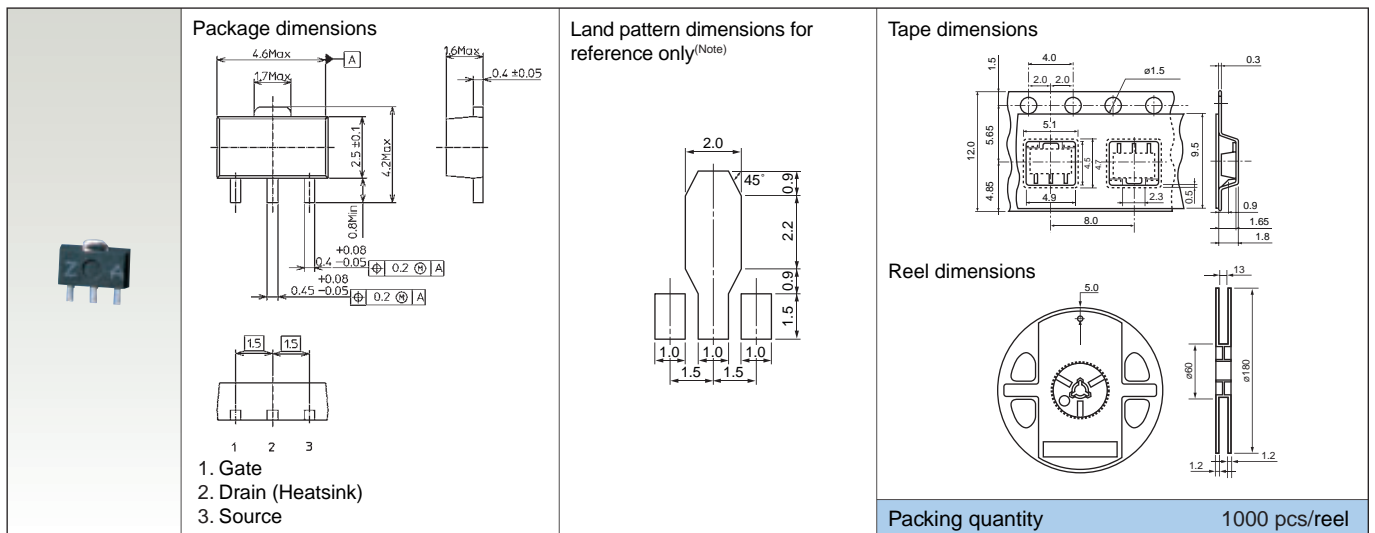

■ New PW-Mold/DPAK+

Unit: mm

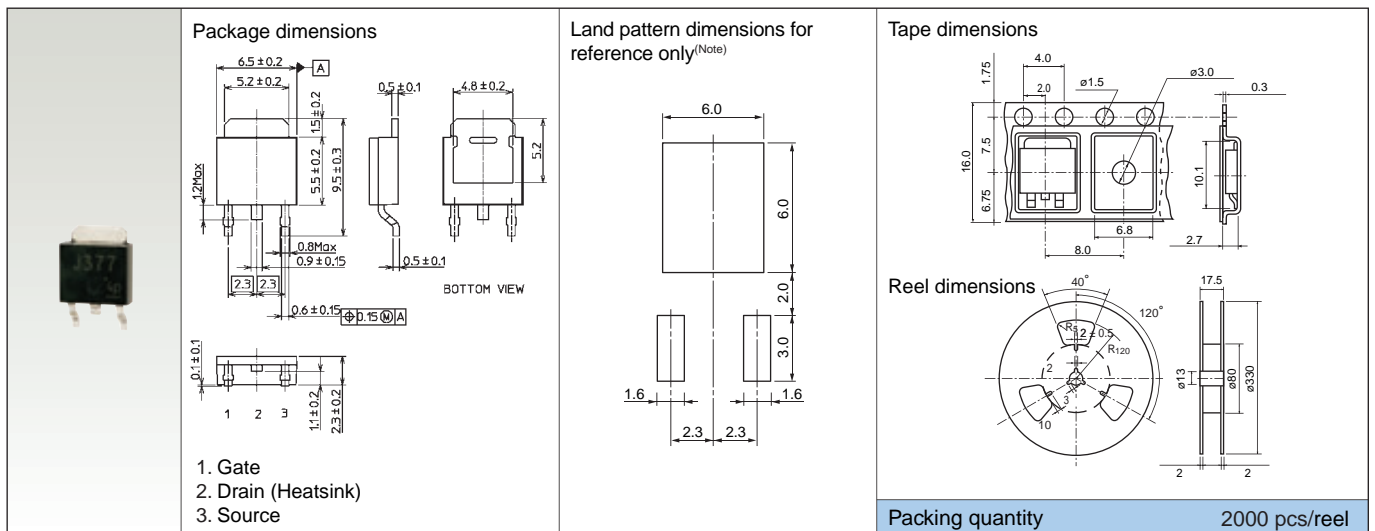

Note: For reference only. Land pattern dimensions should be determined empirically.

■ DPAK

Unit: mm

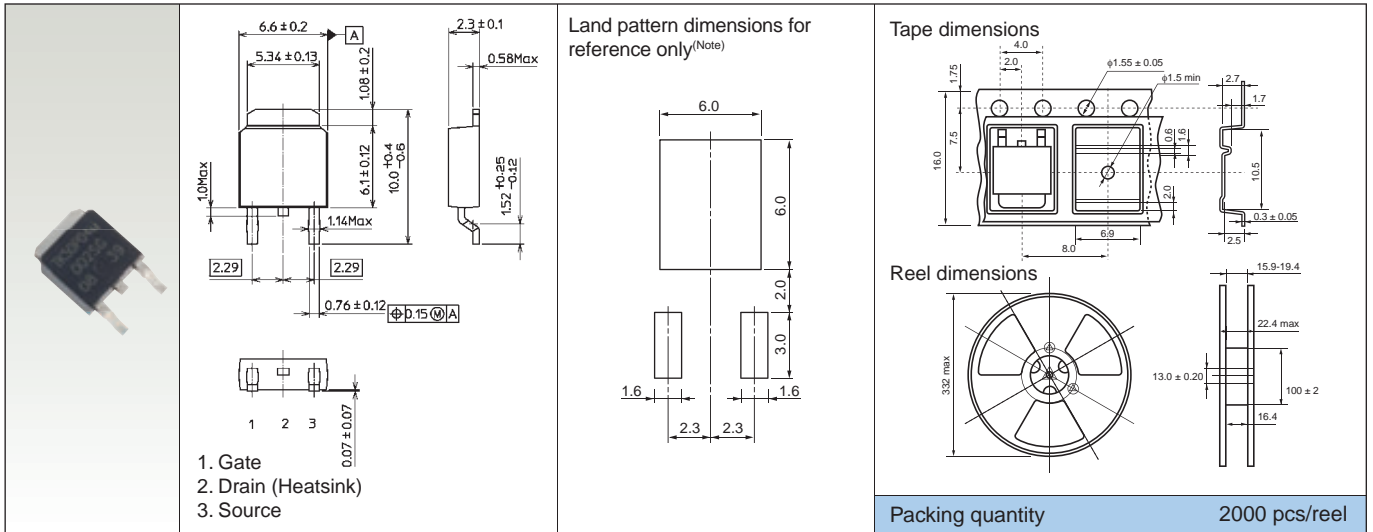

■ TO-220SM(W)

Unit: mm

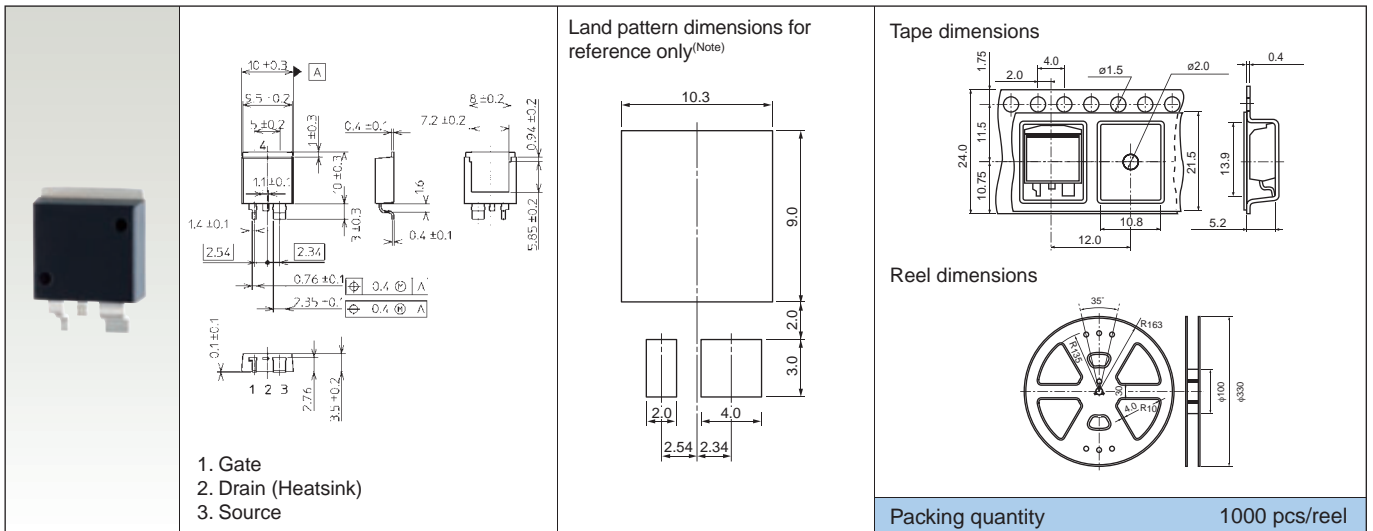

■ TFP

Unit: mm

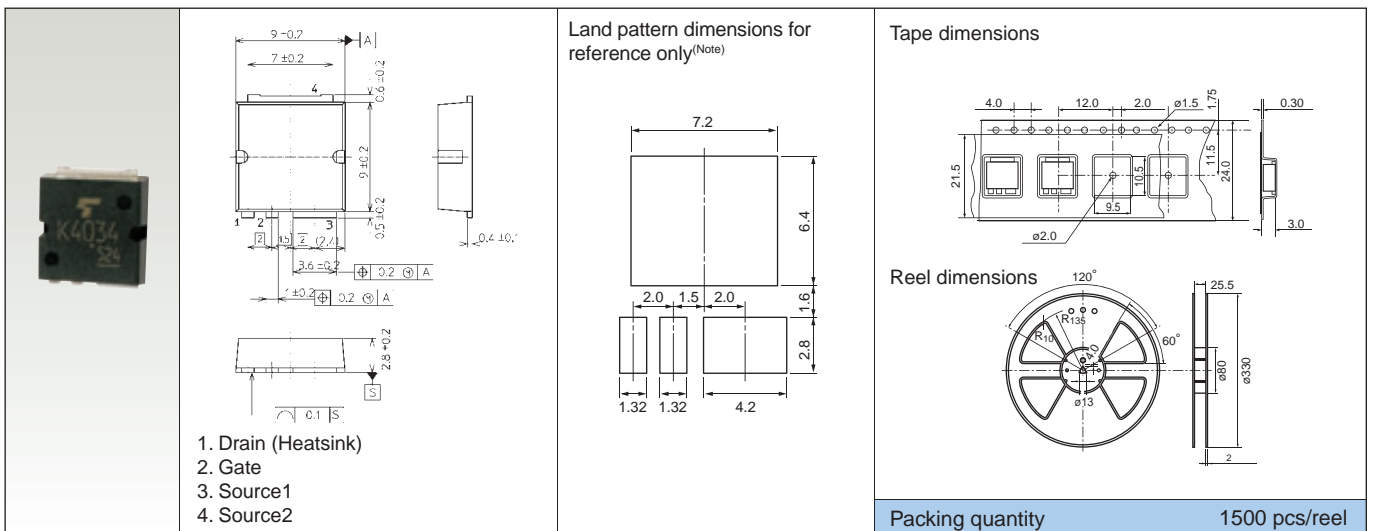

Note: For reference only. Land pattern dimensions should be determined empirically.

9-2 Through-Hole Packages

■ LSTM

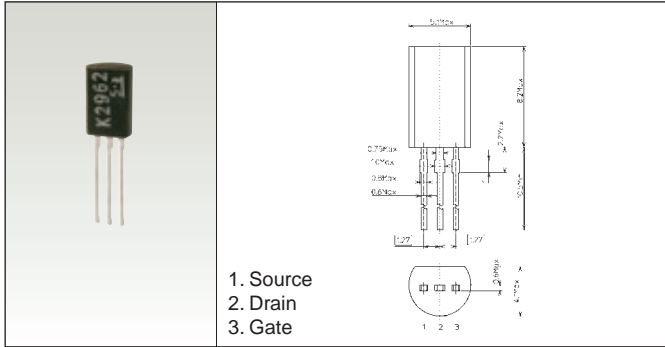

■ New PW-Mold2

Unit: mm

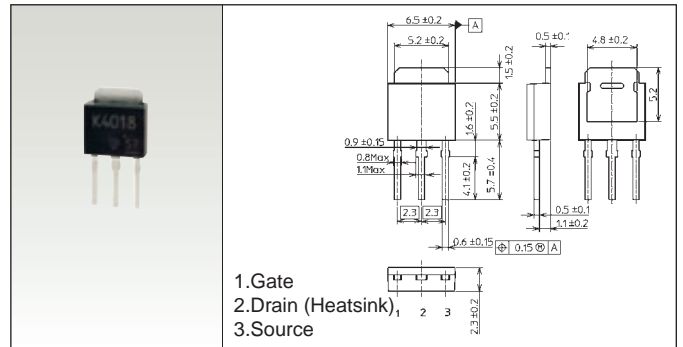

■ TO-220NIS

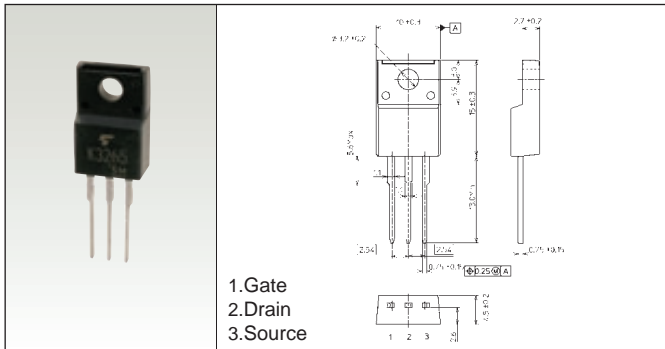

■ TO-220SIS

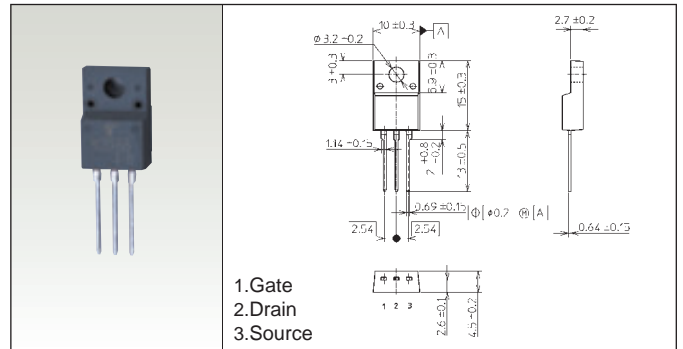

■ TO-220

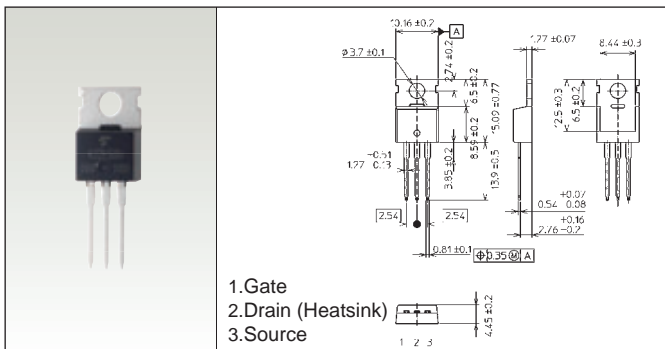

■ TO-3P(N)

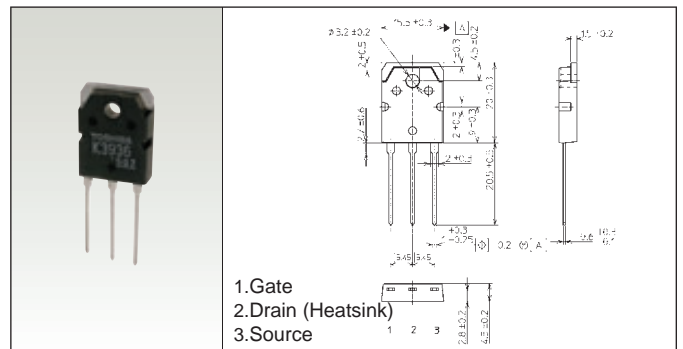

■ TO-3P(N)IS

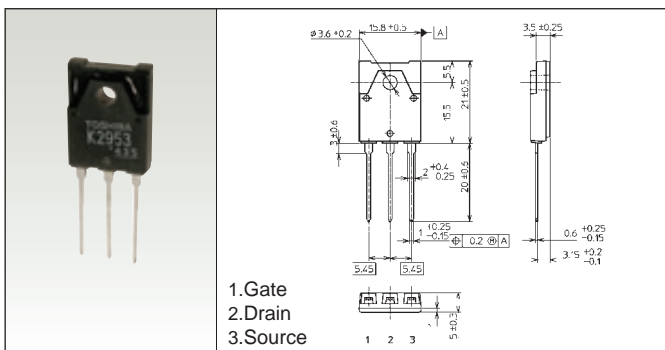

■ TO-3P(L)

