

1 Form A Solid State Relay

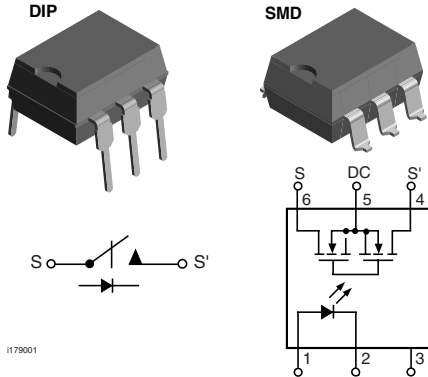

FEATURES

- Current limit protection
- Isolation test voltage 5300 V_{RMS}
- Typical R_{ON} 20 Ω
- Load voltage 350 V
- Load current 150 mA
- High surge capability
- Clean bounce free switching
- Low power consumption
- High reliability monolithic output die
- SMD lead available on tape and reel
- Lead (Pb)-free component
- Component in accordance to RoHS 2002/95/EC and WEEE 2002/96/EC



RoHS
COMPLIANT

DESCRIPTION

The LH1500 is robust, ideal for telecom and ground fault applications. It is an SPST normally open switch (1 form A) that replaces electromechanical relays in many applications. It is constructed using a GaAlAs LED for actuation control and an integrated monolithic die for the switch output. The die, fabricated in a high-voltage dielectrically isolated technology, is comprised of a photodiode array, switch control circuitry and MOSFET switches. In addition, it employs current-limiting circuitry which meets FCC 68.302 and other regulatory voltage surge requirements when overvoltage protection is provided.

APPLICATIONS

- General telecom switching
 - On/off hook control
 - Ring delay
 - Dial pulse
 - Ground start
 - Ground fault protection
- Instrumentation
- Industrial controls

AGENCY APPROVALS

- UL1577: file no. E52744 system code H or J, double protection
- CSA: certification 093751
- BSI/BABT: no. 7980
- FIMKO: approval

ORDER INFORMATION		
PART	REMARKS	PACKAGE
LH1500AT	Thru hole	DIP-6
LH1500AAB		SMD-6
LH1500AABTR	Tape and reel	SMD-6

ABSOLUTE MAXIMUM RATINGS (1)				
PARAMETER	TEST CONDITION	SYMBOL	VALUE	UNIT
SSR				
SSR output power dissipation (continuous)		P_{diss}	550	mW
LED reverse voltage	$I_R \leq 10 \text{ mA}$	V_R	8.0	V
LED continuous forward current		I_F	50	mA
DC or peak AC load voltage	$I_L \leq 50 \text{ mA}$	V_L	350	V
Continuous DC load current - bidirectional	$T_{amb} = 25 \text{ }^\circ\text{C}$	I_L	150	mA
Continuous DC load current - unidirectional	$T_{amb} = 25 \text{ }^\circ\text{C}$	I_L	250	mA
Ambient temperature range		T_{amb}	- 40 to + 85	$^\circ\text{C}$
Storage temperature range		T_{stg}	- 40 to + 150	$^\circ\text{C}$
Soldering temperature (2)	t = 10 s maximum	T_{sld}	260	$^\circ\text{C}$
Isolation test voltage (for 1.0 s)		V_{ISO}	5300	V_{RMS}
Isolation resistance	$V_{IO} = 500 \text{ V}, T_{amb} = 25 \text{ }^\circ\text{C}$	R_{IO}	$\geq 10^{12}$	Ω
	$V_{IO} = 500 \text{ V}, T_{amb} = 100 \text{ }^\circ\text{C}$	R_{IO}	$\geq 10^{11}$	Ω

Note

(1) $T_{amb} = 25 \text{ }^\circ\text{C}$, unless otherwise specified.

Stresses in excess of the absolute maximum ratings can cause permanent damage to the device. Functional operation of the device is not implied at these or any other conditions in excess of those given in the operational sections of this document. Exposure to absolute maximum ratings for extended periods of the time can adversely affect reliability.

(2) Refer to reflow profile for soldering conditions for surface mounted devices (SMD). Refer to wave profile for soldering conditions for through hole devices (DIP).

ELECTRICAL CHARACTERISTICS						
PARAMETER	TEST CONDITION	SYMBOL	MIN.	TYP.	MAX.	UNIT
INPUT						
LED forward current, switch turn-on	$I_L = 100 \text{ mA}, t = 10 \text{ ms}$	I_{Fon}		0.9	2.0	mA
LED forward current, switch turn-off	$V_L = \pm 300 \text{ V}$	I_{Foff}	0.2	0.8		mA
LED forward voltage	$I_F = 10 \text{ mA}$	V_F	1.15	1.25	1.45	V
OUTPUT						
On-resistance, AC/DC: pin 4 (\pm) to 6 (\pm)	$I_F = 5.0 \text{ mA}, I_L = 50 \text{ mA}$	R_{ON}		20	25	Ω
On-resistance, DC: pin 4, 6 (+) to 5 (-)	$I_F = 5.0 \text{ mA}, I_L = 100 \text{ mA}$	R_{ON}	3.0	4.6	6.25	Ω
Off-resistance	$I_F = 0 \text{ mA}, V_L = \pm 100 \text{ V}$	R_{OFF}	0.5	300		$G\Omega$
Current limit AC/DC: pin 4 (\pm) to 6 (\pm)	$I_F = 5.0 \text{ mA}, t = 5.0 \text{ ms}, V_L = \pm 6.0 \text{ V}$	I_{LMT}	230	255	370	mA
Off-state leakage current	$I_F = 0 \text{ mA}, V_L = \pm 100 \text{ V}$	I_O		0.32	200	nA
	$I_F = 0 \text{ mA}, V_L = \pm 350 \text{ V}$	I_O			1.0	μA
Output capacitance, pin 4 to 6	$I_F = 0 \text{ mA}, V_L = 1.0 \text{ V}$	C_O		33		pF
	$I_F = 0 \text{ mA}, V_L = 50 \text{ V}$	C_O		10		pF
Switch offset	$I_F = 5.0 \text{ mA}$	V_{OS}		0.2		μV
TRANSFER						
Capacitance (input to output)	$V_{ISO} = 1.0 \text{ V}$	C_{IO}		0.71		pF
Turn-on time	$I_F = 5.0 \text{ mA}, I_L = 50 \text{ mA}$	t_{on}		0.3	2.0	ms
Turn-off time	$I_F = 5.0 \text{ mA}, I_L = 50 \text{ mA}$	t_{off}		0.6	2.0	ms

Note

$T_{amb} = 25 \text{ }^\circ\text{C}$, unless otherwise specified.

Minimum and maximum values are testing requirements. Typical values are characteristics of the device and are the result of engineering evaluation. Typical values are for information only and are not part of the testing requirements.

TYPICAL CHARACTERISTICS

$T_{amb} = 25\text{ }^{\circ}\text{C}$, unless otherwise specified

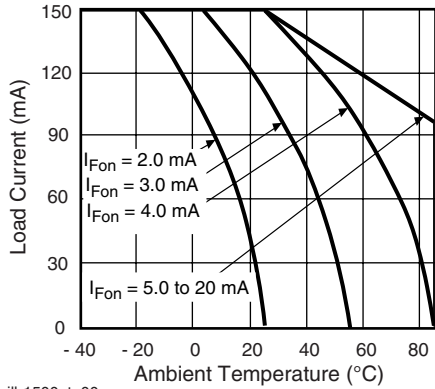

ilh1500at_00

Fig. 1 - Recommended Operating Conditions

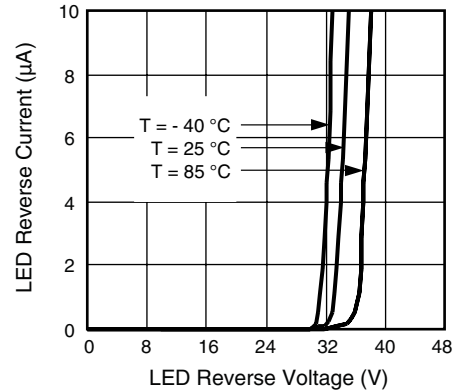

ilh1500at_03

Fig. 4 - LED Reverse Current vs. LED Reverse Voltage

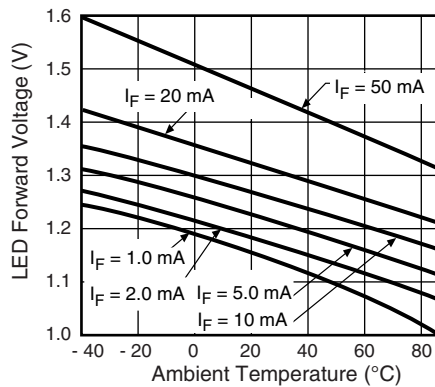

ilh1500at_01

Fig. 2 - LED Voltage vs. Temperature

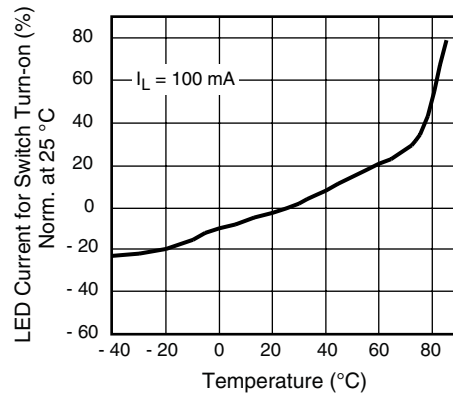

ilh1500at_04

Fig. 5 - LED Current for Switch Turn-on vs. Temperature

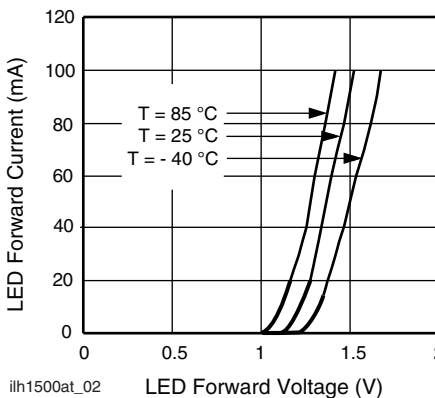

ilh1500at_02

Fig. 3 - LED Forward Current vs. Forward Voltage

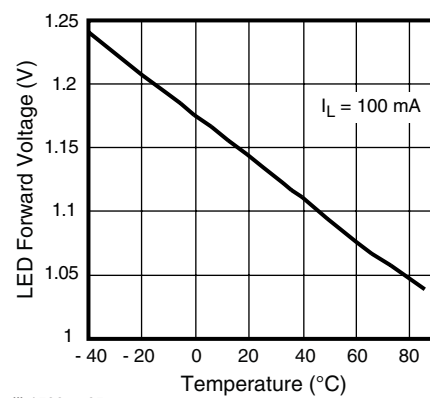

ilh1500at_05

Fig. 6 - LED Dropout Voltage vs. Temperature

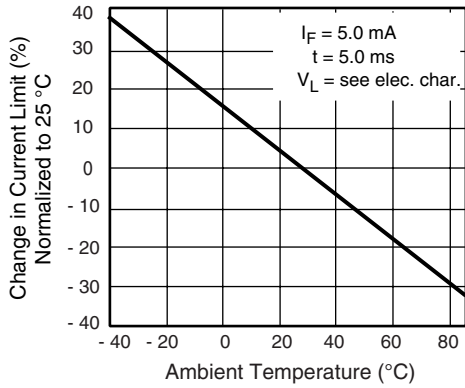

ilh1500at_06

Fig. 7 - Current Limit vs. Temperature

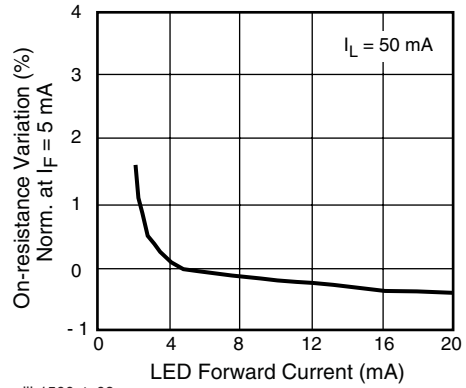

ilh1500at_09

Fig. 10 - Variation in On-Resistance vs. LED Current

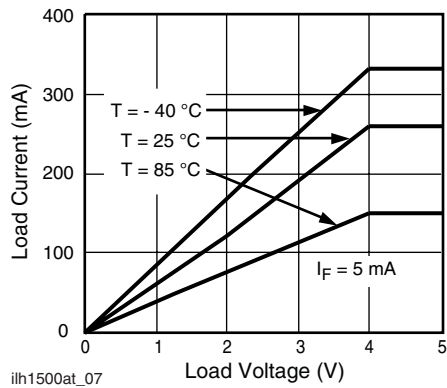

ilh1500at_07

Fig. 8 - Load Current vs. Load Voltage

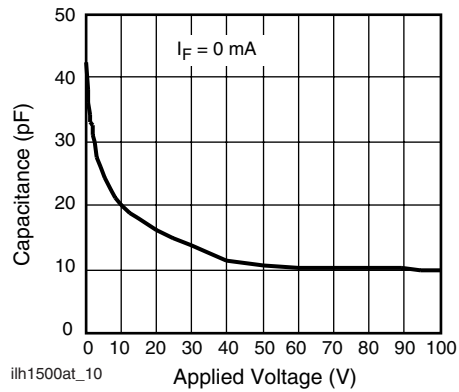

ilh1500at_10

Fig. 11 - Switch Capacitance vs. Applied Voltage

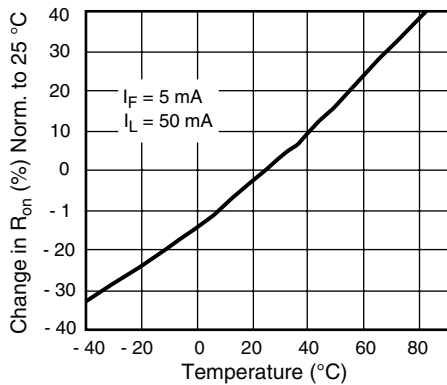

ilh1500at_08

Fig. 9 - On-Resistance vs. Temperature

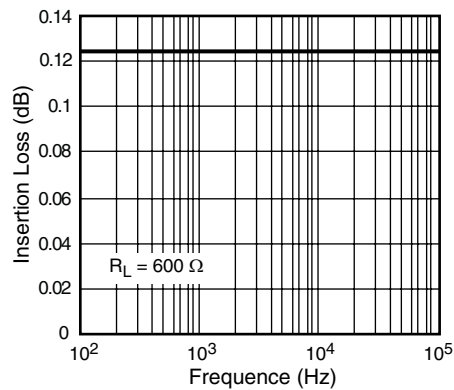

ilh1500at_11

Fig. 12 - Insertion Loss vs. Frequency

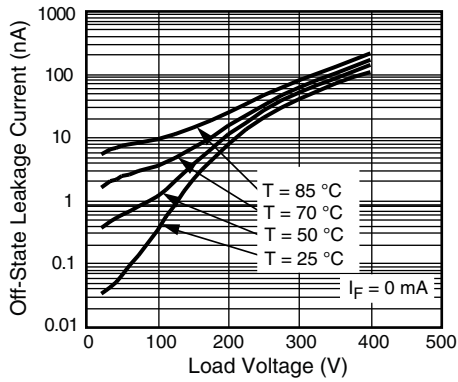

ilh1500at_12

Fig. 13 - Leakage Current vs. Applied Voltage

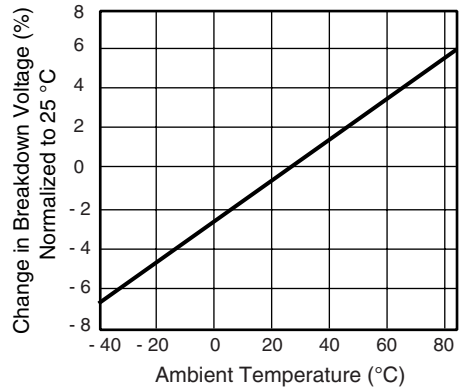

ilh1500at_15

Fig. 16 - Switch Breakdown Voltage vs. Temperature

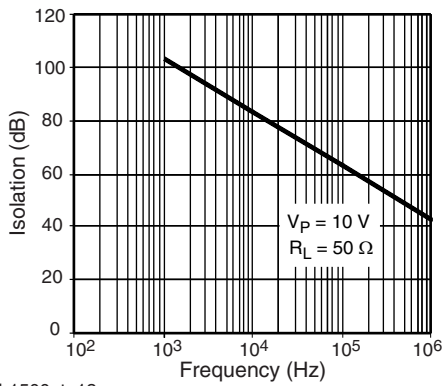

ilh1500at_13

Fig. 14 - Output Isolation

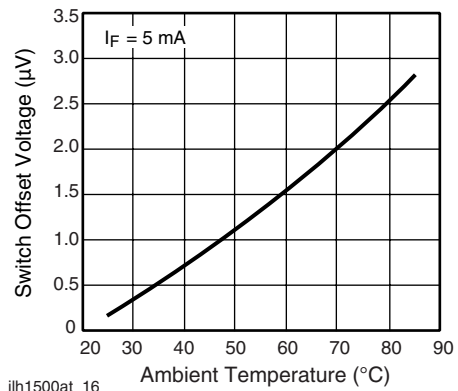

ilh1500at_16

Fig. 17 - Switch Offset Voltage vs. Temperature

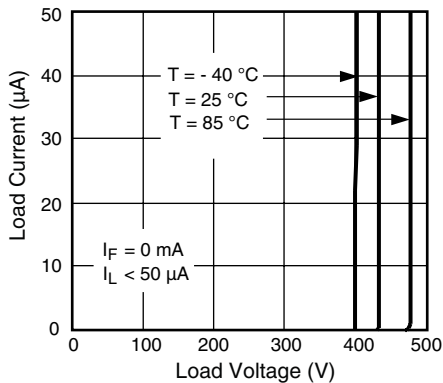

ilh1500at_14

Fig. 15 - Switch Breakdown Voltage vs. Load Current

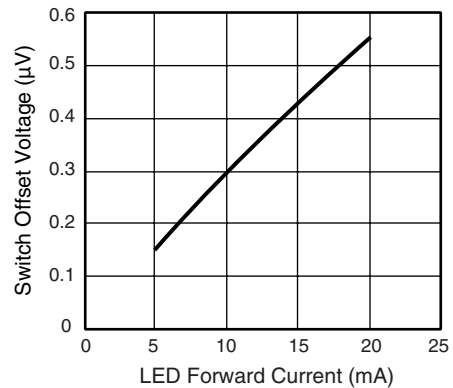

ilh1500at_17

Fig. 18 - Switch Offset Voltage vs. LED Current

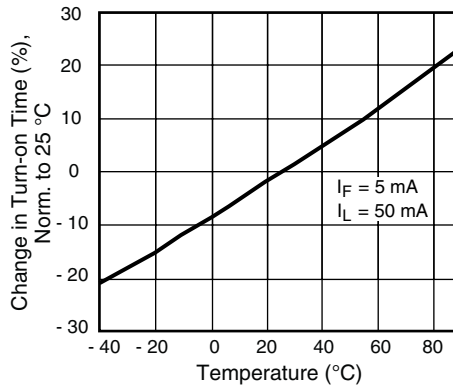

ilh1500at_18

Fig. 19 - Turn-on Time vs. Temperature

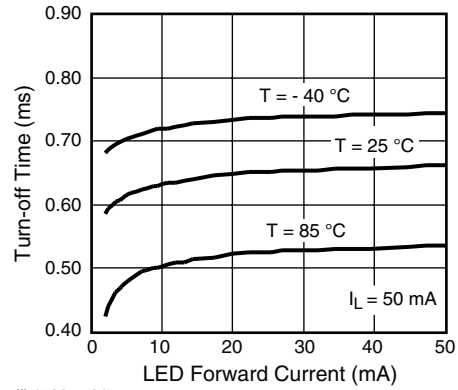

ilh1500at_21

Fig. 22 - Turn-off Time vs. LED Current

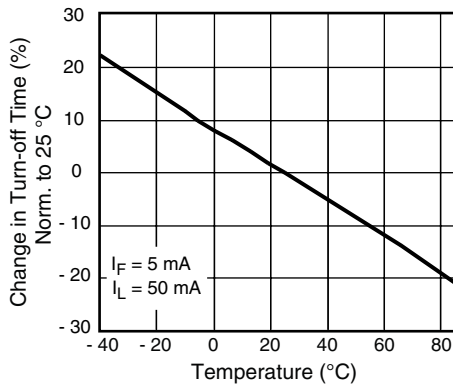

ilh1500at_19

Fig. 20 - Turn-off Time vs. Temperature

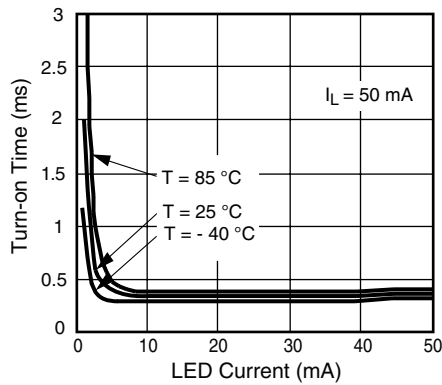

ilh1500at_20

Fig. 21 - Turn-on Time vs. LED Current



LH1500AAB, LH1500AABTR, LH1500AT

1 Form A Solid State Relay

Vishay Semiconductors

PACKAGE DIMENSIONS in inches (millimeters)

DIP

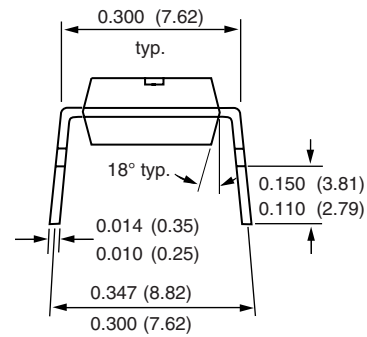
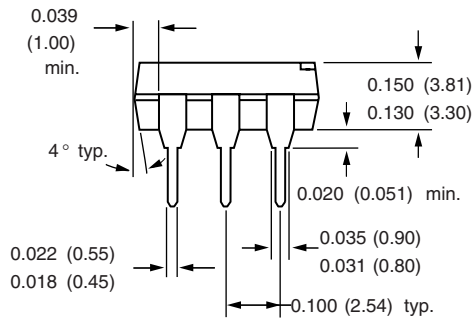
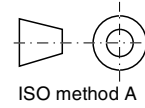
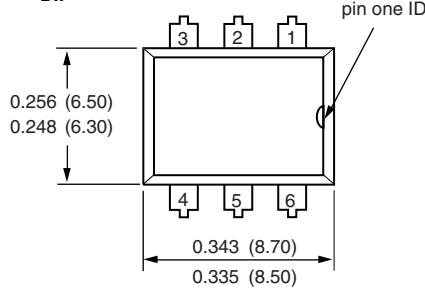

i178001

SMD

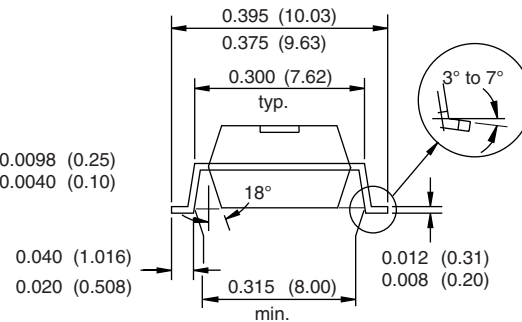
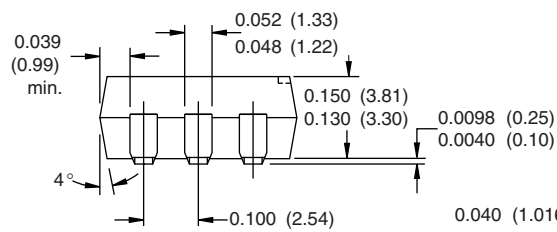
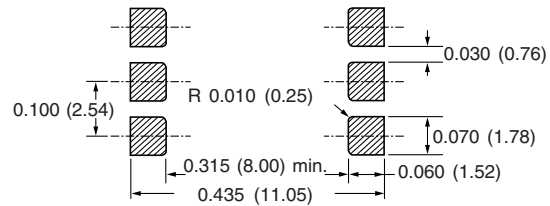
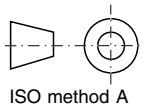
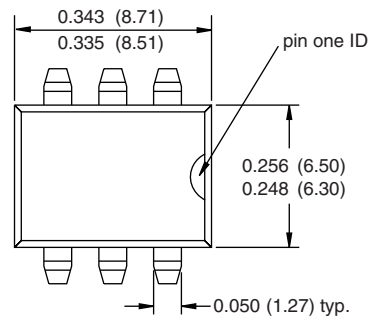

i178002



OZONE DEPLETING SUBSTANCES POLICY STATEMENT

It is the policy of Vishay Semiconductor GmbH to

1. Meet all present and future national and international statutory requirements.
2. Regularly and continuously improve the performance of our products, processes, distribution and operating systems with respect to their impact on the health and safety of our employees and the public, as well as their impact on the environment.

It is particular concern to control or eliminate releases of those substances into the atmosphere which are known as ozone depleting substances (ODSs).

The Montreal Protocol (1987) and its London Amendments (1990) intend to severely restrict the use of ODSs and forbid their use within the next ten years. Various national and international initiatives are pressing for an earlier ban on these substances.

Vishay Semiconductor GmbH has been able to use its policy of continuous improvements to eliminate the use of ODSs listed in the following documents.

1. Annex A, B and list of transitional substances of the Montreal Protocol and the London Amendments respectively.
2. Class I and II ozone depleting substances in the Clean Air Act Amendments of 1990 by the Environmental Protection Agency (EPA) in the USA
3. Council Decision 88/540/EEC and 91/690/EEC Annex A, B and C (transitional substances) respectively.

Vishay Semiconductor GmbH can certify that our semiconductors are not manufactured with ozone depleting substances and do not contain such substances.

We reserve the right to make changes to improve technical design
and may do so without further notice.

Parameters can vary in different applications. All operating parameters must be validated for each customer application by the customer. Should the buyer use Vishay Semiconductors products for any unintended or unauthorized application, the buyer shall indemnify Vishay Semiconductors against all claims, costs, damages, and expenses, arising out of, directly or indirectly, any claim of personal damage, injury or death associated with such unintended or unauthorized use.

Vishay Semiconductor GmbH, P.O.B. 3535, D-74025 Heilbronn, Germany



Disclaimer

All product specifications and data are subject to change without notice.

Vishay Intertechnology, Inc., its affiliates, agents, and employees, and all persons acting on its or their behalf (collectively, "Vishay"), disclaim any and all liability for any errors, inaccuracies or incompleteness contained herein or in any other disclosure relating to any product.

Vishay disclaims any and all liability arising out of the use or application of any product described herein or of any information provided herein to the maximum extent permitted by law. The product specifications do not expand or otherwise modify Vishay's terms and conditions of purchase, including but not limited to the warranty expressed therein, which apply to these products.

No license, express or implied, by estoppel or otherwise, to any intellectual property rights is granted by this document or by any conduct of Vishay.

The products shown herein are not designed for use in medical, life-saving, or life-sustaining applications unless otherwise expressly indicated. Customers using or selling Vishay products not expressly indicated for use in such applications do so entirely at their own risk and agree to fully indemnify Vishay for any damages arising or resulting from such use or sale. Please contact authorized Vishay personnel to obtain written terms and conditions regarding products designed for such applications.

Product names and markings noted herein may be trademarks of their respective owners.