

Panasonic

ideas for life

**Normally closed
SOP4-pin type
of 60V/350V/400V
load voltage**

**PhotoMOS[®]
GU SOP 1 Form B
(AQY410S)**

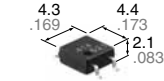

mm inch

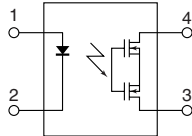

RoHS compliant

FEATURES

1. Small SOP4-pin package

The device comes in a super-miniature SO package 4-pin type measuring (W) 4.3×(L) 4.4×(H) 2.1 mm (W) .169×(L) .173×(H) .083 inch

2. Low on-resistance

The AQO4 series (normally closed type) has a low on-resistance.

This has been achieved thanks to the built-in MOSFET processed by our proprietary method, DSD (Double-diffused and Selective Doping) method.

3. Controls low-level analog signals

PhotoMOS feature extremely low closed-circuit offset voltage to enable control of low-level analog signals without distortion.

4. Low-level off-state leakage current of max. 1 μA

TYPICAL APPLICATIONS

- Power supply
- Measuring instruments
- Security equipment
- Telephone equipment
- Sensing equipment

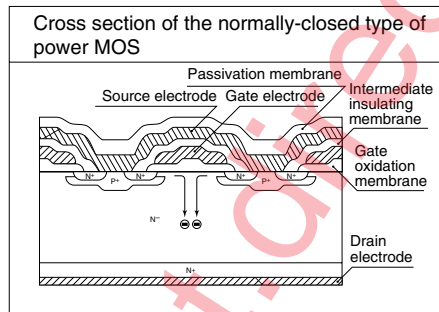

TYPES

	Output rating*		Package	Part No.			Packing quantity	
	Load voltage	Load current		Tube packing style	Tape and reel packing style		Tube	Tape and reel
					Picked from the 1/2-pin side	Picked from the 3/4-pin side		
AC/DC dual use	60V	500mA	SOP4-pin	AQY412S	AQY412SX	AQY412SZ	1 tube contains: 100 pcs. 1 batch contains: 2,000 pcs.	1,000 pcs.
	350V	120mA		AQY410S	AQY410SX	AQY410SZ		
	400V	100mA		AQY414S	AQY414SX	AQY414SZ		

* Indicate the peak AC and DC values.

Note: For space reasons, the three initial letters of the part number "AQY", the surface mount terminal shape indicator "S" and the packing style indicator "X" or "Z" are not marked on the device. (Ex. the label for product number AQY412SX is 412)

RATING

1. Absolute maximum ratings (Ambient temperature: 25°C 77°F)

Item		Symbol	AQY412S	AQY410S	AQY414S	Remarks
Input	LED forward current	I _F	50 mA			
	LED reverse voltage	V _R	5 V			
	Peak forward current	I _{FP}	1 A			f = 100 Hz, Duty factor = 0.1%
	Power dissipation	P _{in}	75 mW			
Output	Load voltage (peak AC)	V _L	60 V	350 V	400 V	
	Continuous load current	I _L	0.5 A	0.12 A	0.1 A	Peak AC, DC
	Peak load current	I _{peak}	1.5 A	0.3 A	0.24 A	100ms (1 shot), V _L = DC
	Power dissipation	P _{out}	300 mW			
Total power dissipation		P _T	350 mW			
I/O isolation voltage		V _{iso}	1,500 V AC			
Temperature limits	Operating	T _{opr}	-40°C to +85°C -40°F to +185°F			Non-condensing at low temperatures
	Storage	T _{stg}	-40°C to +100°C -40°F to +212°F			

GU SOP 1 Form B (AQY41OS)

2. Electrical characteristics (Ambient temperature: 25°C 77°F)

Item		Symbol	AQY412S	AQY410S	AQY414S	Remarks
Input	LED operate (OFF) current	Typical	0.9 mA			I _L = Max.
		Maximum	3 mA			
	LED reverse (ON) current	Minimum	0.4 mA			I _L = Max.
		Typical	0.85 mA			
LED dropout voltage	Typical	1.25 V (1.14 V at I _F = 5 mA)			I _F = 50 mA	
	Maximum	1.5 V				
Output	On resistance	Typical	1 Ω	18 Ω	26 Ω	I _F = 0 mA I _L = Max. Within 1 s on time
		Maximum	2.5 Ω	25 Ω	35 Ω	
	Off state leakage current	Maximum	1 μA			I _F = 5 mA V _L = Max.
Transfer characteristics	Operate (OFF) time*	Typical	0.9 ms	0.52 ms	0.47 ms	I _F = 0 mA → 5 mA I _L = Max.
		Maximum	3 ms	1 ms		
	Reverse (ON) time*	Typical	0.21 ms	0.23 ms	0.28 ms	I _F = 5 mA → 0 mA I _L = Max.
		Maximum	1 ms			
	I/O capacitance	Typical	0.8 pF			f = 1 MHz V _B = 0 V
		Maximum	1.5 pF			
Initial I/O isolation resistance	Minimum	R _{iso}	1,000 MΩ			500 V DC

*Operate/Reverse time

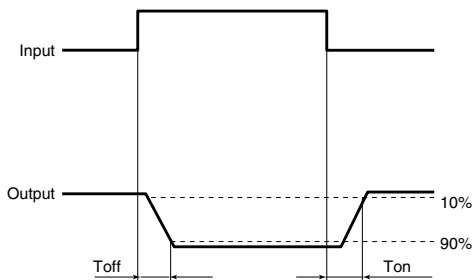

RECOMMENDED OPERATING CONDITIONS

Please obey the following conditions to ensure proper device operation and resetting.

Item	Symbol	Recommended value	Unit
Input LED current	I _F	5	mA

- For Dimensions.
- For Schematic and Wiring Diagrams.
- For Cautions for Use.

■ These products are not designed for automotive use.

If you are considering to use these products for automotive applications, please contact your local Panasonic Corporation technical representative.
For more information.

REFERENCE DATA

1. Load current vs. ambient temperature characteristics

Allowable ambient temperature:

-40°C to +85°C

-40°F to +185°F

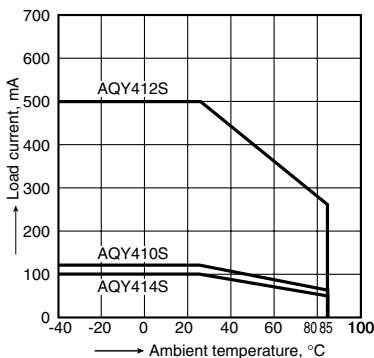

2. On resistance vs. ambient temperature characteristics

Measured portion: between terminals 3 and 4;

LED current: 0 mA;

Continuous load current: Max.(DC)

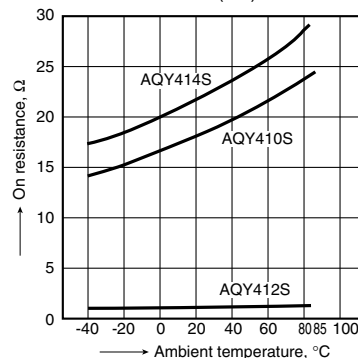

3. Operate (OFF) time vs. ambient temperature characteristics

LED current: 5 mA; Load voltage: Max.(DC);

Continuous load current: Max.(DC)

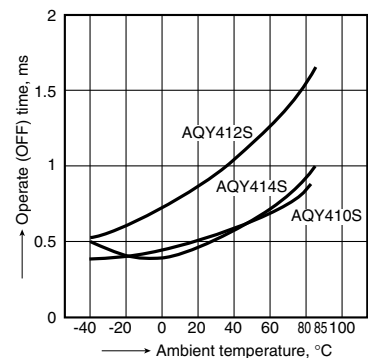

4. Reverse (ON) time vs. ambient temperature characteristics

LED current: 5 mA; Load voltage: Max.(DC);
Continuous load current: Max.(DC)

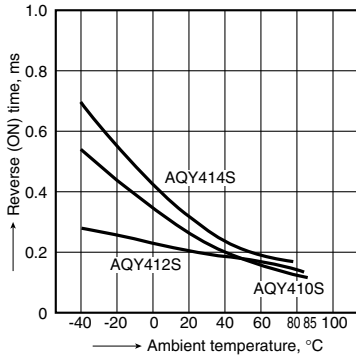

5. LED operate (OFF) current vs. ambient temperature characteristics

Sample: All types;
Load voltage: Max.(DC);
Continuous load current: Max.(DC)

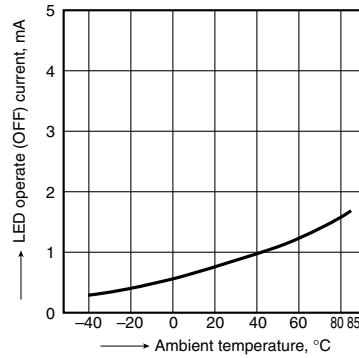

6. LED reverse (ON) current vs. ambient temperature characteristics

Sample: All types;
Load voltage: Max.(DC);
Continuous load current: Max.(DC)

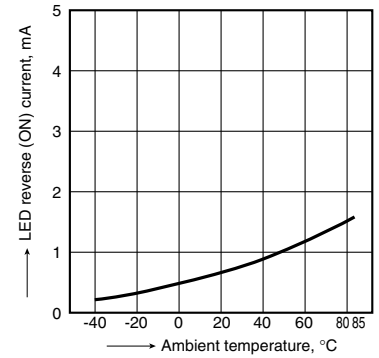

7. LED dropout voltage vs. ambient temperature characteristics

Sample: All types;
LED current: 5 to 50 mA

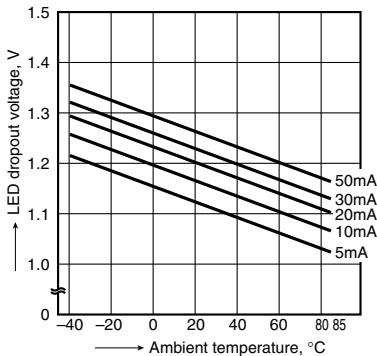

8-(1). Current vs. voltage characteristics of output at MOS portion

Measured portion: between terminals 3 and 4;
Ambient temperature: 25°C 77°F

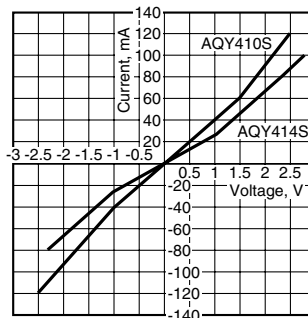

8-(2). Current vs. voltage characteristics of output at MOS portion

Measured portion: between terminals 3 and 4;
Ambient temperature: 25°C 77°F

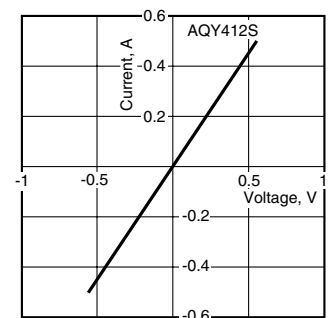

9-(1). Off state leakage current vs. load voltage characteristics

Measured portion: between terminals 3 and 4;
LED current: 5 mA; Ambient temperature: 25°C 77°F

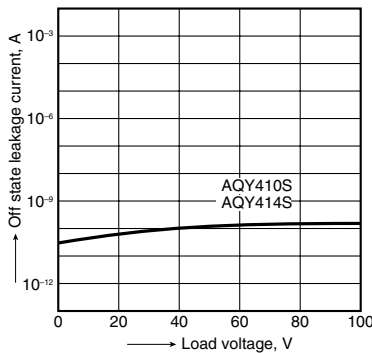

9-(2). Off state leakage current vs. load voltage characteristics

Measured portion: between terminals 3 and 4;
LED current: 5 mA; Ambient temperature: 25°C 77°F

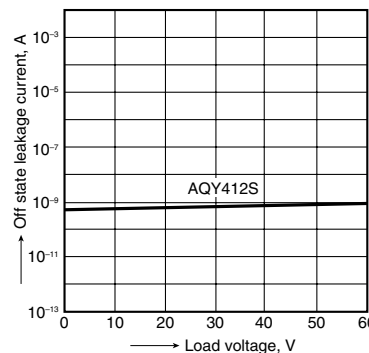

10. Operate (OFF) time vs. LED forward current characteristics

Measured portion: between terminals 3 and 4;
Load voltage: Max.(DC); Continuous load current: Max.(DC); Ambient temperature: 25°C 77°F

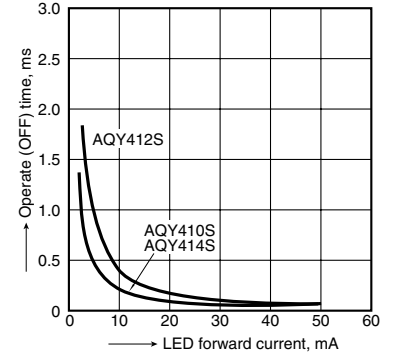

11. Reverse (ON) time vs. LED forward current characteristics

Measured portion: between terminals 3 and 4;
Load voltage: Max.(DC); Continuous load current: Max.(DC); Ambient temperature: 25°C 77°F

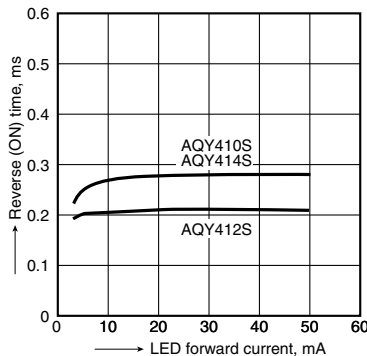

12-(1). Output capacitance vs. applied voltage characteristics

Measured portion: between terminals 3 and 4;
Frequency: 1 MHz;
LED current: 5 mA; Ambient temperature: 25°C 77°F

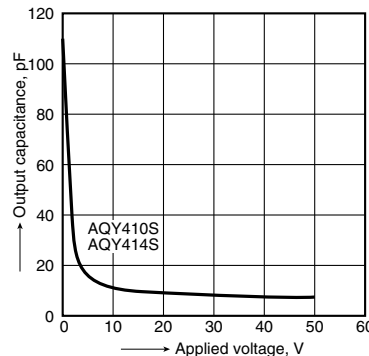

12-(2). Output capacitance vs. applied voltage characteristics

Measured portion: between terminals 3 and 4;
Frequency: 1 MHz;
LED current: 5 mA; Ambient temperature: 25°C 77°F

