

# Chip Monolithic Ceramic Capacitors for Automotive

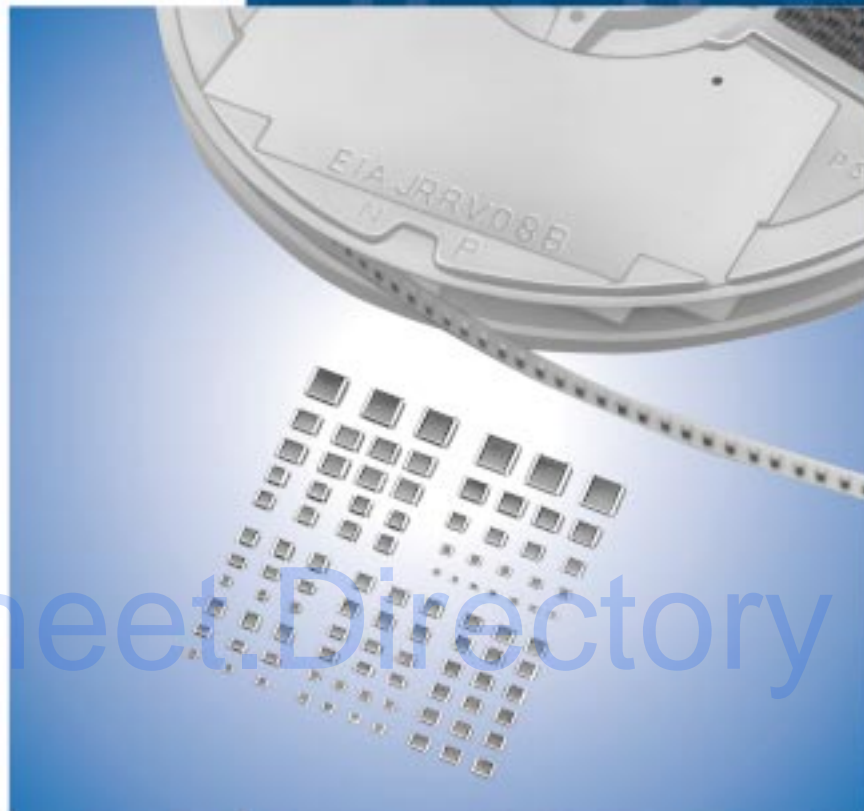

Datasheet.Directory

#### **for EU RoHS Compliant**

- All the products in this catalog comply with EU RoHS.
- EU RoHS is "the European Directive 2002/95/EC on the Restriction of the Use of Certain Hazardous Substances in Electrical and Electronic Equipment".
- For more details, please refer to our website 'Murata's Approach for EU RoHS' (<http://www.murata.com/info/rohs.html>).

# CONTENTS

1

<b>Part Numbering</b>	2
<b>Selection Guide of Chip Monolithic Ceramic Capacitors</b>	4
<b>1 for Automotive GCM Series</b>	5
● Capacitance Table	6
<b>Temperature Compensating Type</b>	8
<b>High Dielectric Constant Type</b>	10
● Specifications and Test Methods	14
● Package	19
● △Caution (Storage and Operation Condition)	22
● △Caution (Rating)	23
● △Caution (Soldering and Mounting)	27
● △Caution (Others)	33
● Notice (Rating)	34
● Notice (Soldering and Mounting)	35
● Notice (Others)	38
<b>2 Medium Voltage for Automotive GCM Series Low Dissipation Factor</b>	39
● Specifications and Test Methods	41
<b>3 Medium Voltage for Automotive GCJ Series Soft Termination Type</b>	45
● Specifications and Test Methods	46
<b>Medium Voltage Data (Typical Example)</b>	50
<b>Package</b>	51
<b>△Caution</b>	53
<b>Notice</b>	61

2

3

● Part Numbering

Chip Monolithic Ceramic Capacitors

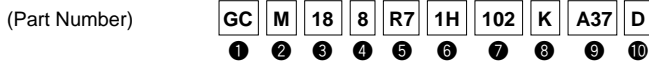

① Product ID

② Series

Product ID	Code	Series
<b>GC</b>	<b>J</b>	Soft Termination Type Power-train, Safety Equipment
	<b>M</b>	Power-train, Safety Equipment

③ Dimension (L×W)

Code	Dimension (L×W)	EIA
<b>03</b>	0.6×0.3mm	0201
<b>15</b>	1.0×0.5mm	0402
<b>18</b>	1.6×0.8mm	0603
<b>21</b>	2.0×1.25mm	0805
<b>31</b>	3.2×1.6mm	1206
<b>32</b>	3.2×2.5mm	1210
<b>43</b>	4.5×3.2mm	1812
<b>55</b>	5.7×5.0mm	2220

④ Dimension (T)

Code	Dimension (T)
<b>3</b>	0.3mm
<b>5</b>	0.5mm
<b>6</b>	0.6mm
<b>8</b>	0.8mm
<b>9</b>	0.85mm
<b>A</b>	1.0mm
<b>B</b>	1.25mm
<b>C</b>	1.6mm
<b>D</b>	2.0mm
<b>E</b>	2.5mm
<b>M</b>	1.15mm
<b>N</b>	1.35mm
<b>Q</b>	1.5mm
<b>R</b>	1.8mm
<b>X</b>	Depends on individual standards.

⑤ Temperature Characteristics

Temperature Characteristic Codes			Temperature Characteristics			Operating Temperature Range
Code	Public STD Code		Reference Temperature	Temperature Range	Capacitance Change or Temperature Coefficient	
<b>5C</b>	C0G	EIA	25°C	25 to 125°C	0±30ppm/°C	-55 to 125°C
<b>7U</b>	U2J	EIA	25°C	25 to 125°C	-750±120ppm/°C	-55 to 125°C
<b>C7</b>	X7S	EIA	25°C	-55 to 125°C	±22%	-55 to 125°C
<b>R7</b>	X7R	EIA	25°C	-55 to 125°C	±15%	-55 to 125°C

● Capacitance Change from each temperature

Murata Code	Capacitance Change from 25°C (%)					
	-55°C		-30°C		-10°C	
	Max.	Min.	Max.	Min.	Max.	Min.
<b>5C</b>	0.58	-0.24	0.40	-0.17	0.25	-0.11
<b>7U</b>	8.78	5.04	6.04	3.47	3.84	2.21

⑥ Rated Voltage

Code	Rated Voltage
<b>0J</b>	DC6.3V
<b>1A</b>	DC10V
<b>1C</b>	DC16V
<b>1E</b>	DC25V
<b>YA</b>	DC35V
<b>1H</b>	DC50V
<b>2A</b>	DC100V
<b>2E</b>	DC250V
<b>2J</b>	DC630V

⑦ Capacitance

Expressed by three-digit alphanumerics. The unit is pico-farad (pF). The first and second figures are significant digits, and the third figure expresses the number of zeros which follow the two numbers.  
 If there is a decimal point, it is expressed by the capital letter "R". In this case, all figures are significant digits.

Ex.)

Code	Capacitance
<b>R50</b>	0.5pF
<b>1R0</b>	1.0pF
<b>100</b>	10pF
<b>103</b>	10000pF

Continued on the following page.

☐ Continued from the preceding page.

③ Capacitance Tolerance

Code	Capacitance Tolerance	TC	Series	Capacitance Step	
<b>C</b>	±0.25pF	C0G	<b>GCM</b>	≤5pF	E12, 1pF Step *
<b>D</b>	±0.5pF	C0G	<b>GCM</b>	6.0 to 9.0pF	E12, 1pF Step *
<b>J</b>	±5%	C0G	<b>GCM</b>	≥10pF	E12 Step
		U2J	<b>GCM</b>	E12 Step	
<b>K</b>	±10%	X7S, X7R	<b>GCJ/GCM</b>	E6 Step	
<b>M</b>	±20%	X7S, X7R	<b>GCM</b>	E6 Step	

\* E24 series is also available.

⑨ Individual Specification Code

Expressed by three figures.

⑩ Package

Code	Package
<b>L</b>	ø180mm Embossed Taping
<b>D</b>	ø180mm Paper Taping
<b>K</b>	ø330mm Embossed Taping
<b>J</b>	ø330mm Paper Taping
<b>B</b>	Bulk
<b>C</b>	Bulk Case

## Selection Guide of Chip Monolithic Ceramic Capacitors

Applications?	Function	Type	Series
	Decoupling, Smoothing		High Capacitance
		Array (2 or 4 Elements)	<b>GNM</b> 10pF-2.2μF
Frequency Control/Tuning, Impedance Matching		Class 1 TC's	<b>GRM (C0G)</b> 0.1pF-0.1μF
			<b>GRM (U2J etc.)</b>
High Speed Decoupling		Low Inductance (Reverse Geometry)	<b>LLL</b> 2200pF-10μF
		Low Inductance (Multi Termination)	<b>LLA/LLM (From 1GHz)</b> 0.01μF-4.7μF
High Frequency		Low ESR (50V to 500V)	<b>ERB (1MHz to 1GHz)</b> 0.5pF-1000pF
		Low ESR, Ultra Small	<b>GJM (500MHz to 10GHz)</b> 0.1pF-33pF
		Lowest ESR	<b>GQM (500MHz to 10GHz)</b> 0.1pF-100pF
Optical Communications		Wire-Die-Bonding	<b>GMA</b> 100pF-0.47μF <b>GMD</b> 100pF-1μF
Medium Voltage High Frequency Snubber		250V/630V/1kV/2kV/3.15kV Low Dissipation	<b>GRM (C0G, U2J)</b> 10pF-10000pF
Medium Voltage LCD Backlight Inverter		3.15kV Low Dissipation	<b>GRM (C0G)</b> 5pF-47pF
Medium Voltage Decoupling, Smoothing		250V/630V/1kV High Capacitance	<b>GRM (X7R)</b> 220pF-1μF
Medium Voltage Only for Camera Flash Circuit		350V High Capacitance	<b>GR7</b> 10000pF-47000pF
Medium Voltage Only for Information Devices		2kV High Capacitance	<b>GR4</b> 100pF-10000pF
		Safety Standard Certified	<b>Type GD</b> 10pF-4700pF <b>Type GF</b> 10pF-4700pF
AC Lines Noise Removal		Safety Standard Certified	<b>Type GC</b> 100pF-330pF <b>Type GF</b> 470pF-4700pF <b>Type GB</b> 10000pF-56000pF
		AC250V which meet Japanese Law	<b>GA2</b> 470pF-0.1μF
Automotive (Powertrain, Safety Equipment)		High Capacitance	<b>GCM (X7R etc.)</b> 100pF-47μF
		Class 1 TC's	<b>GCM (C0G etc.)</b> 1.0pF-56000pF
Medium Voltage for Automotive (Powertrain, Safety Equipment)		250V/630V Low Dissipation	<b>GCM (U2J)</b> 10pF-10000pF
		250V/630V Soft Termination Type	<b>GCJ (X7R)</b> 1000pF-0.47μF

# Chip Monolithic Ceramic Capacitors for Automotive



## for Automotive GCM Series

### ■ Features

1. The GCM series meet AEC-Q200 requirements.
2. Higher resistance of solder-leaching due to the Ni-barriered termination, applicable for reflow-soldering, and flow-soldering (GCM18/21/31 type only).
3. The operating temperature range of R7/C7/5C series: -55 to 125 degree C.
4. A wide selection of sizes is available, from miniature LxWxT:0.6x0.3x0.3mm to LxWxT: 3.2x2.5x2.5mm.
5. The GCM series is available in paper or embossed tape and reel packaging for automatic placement.
6. The GCM series is lead free product.

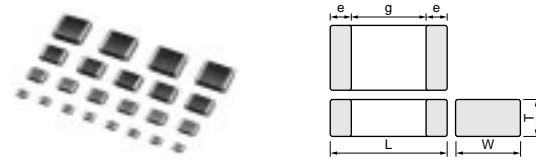

Part Number	Dimensions (mm)				
	L	W	T	e	g min.
<b>GCM033</b>	0.6 ±0.03	0.3 ±0.03	0.3 ±0.03	0.1 to 0.2	0.2
<b>GCM155</b>	1.0 ±0.05	0.5 ±0.05	0.5 ±0.05	0.15 to 0.35	0.3
<b>GCM188*</b>	1.6 ±0.1	0.8 ±0.1	0.8 ±0.1	0.2 to 0.5	0.5
<b>GCM216</b>			0.6 ±0.1		
<b>GCM219</b>	2.0 ±0.15	1.25 ±0.15	0.85 ±0.1	0.2 to 0.7	0.7
<b>GCM21B</b>			1.25 ±0.15		
<b>GCM319</b>	3.2 ±0.15	1.6 ±0.15	0.85 ±0.1	0.3 to 0.8	1.5
<b>GCM31M</b>			1.15 ±0.1		
<b>GCM31C</b>	3.2 ±0.2	1.6 ±0.2	1.6 ±0.2		
<b>GCM32N</b>			1.35 ±0.15		
<b>GCM32R</b>	3.2 ±0.3	2.5 ±0.2	1.8 ±0.2	0.3 min.	1.0
<b>GCM32D</b>			2.0 ±0.2		
<b>GCM32E</b>			2.5 ±0.2		

\* Bulk Case: 1.6 ±0.07(L) × 0.8 ±0.07(W) × 0.8 ±0.07(T)  
 The figure indicates typical specification.

### ■ Applications

Automotive electronic equipment (Power-train, safety equipment)

# Capacitance Table

## Temperature Compensating Type C0G(5C)

6 ex.6: T Dimension Part Number Code

Capacitance	LxW [mm]	0.6x0.3 (03)		1.0x0.5 (15)		1.6x0.8 (18)		2.0x1.25 (21)		3.2x1.6 (31)	
		<020>	<040>	<060>	<080>	<100>	<125>	<160>	<200>		
Rated Voltage [Vdc]		25 (1E)	50 (1H)	100 (2A)	50 (1H)	100 (2A)	50 (1H)	100 (2A)	50 (1H)		
1.0pF(1R0)		3	5	8	8						
2.0pF(2R0)		3	5	8	8						
3.0pF(3R0)		3	5	8	8						
4.0pF(4R0)		3	5	8	8						
5.0pF(5R0)		3	5	8	8						
6.0pF(6R0)		3	5	8	8						
7.0pF(7R0)		3	5	8	8						
8.0pF(8R0)		3	5	8	8						
9.0pF(9R0)		3	5	8	8						
10pF(100)		3	5	8	8						
12pF(120)		3	5	8	8						
15pF(150)		3	5	8	8						
18pF(180)		3	5	8	8						
22pF(220)		3	5	8	8						
27pF(270)		3	5	8	8						
33pF(330)		3	5	8	8						
39pF(390)		3	5	8	8						
47pF(470)		3	5	8	8						
56pF(560)		3	5	8	8						
68pF(680)		3	5	8	8						
82pF(820)		3	5	8	8						
100pF(101)		3	5	8	8	6					
120pF(121)			5	8	8	6					
150pF(151)			5	8	8	6					
180pF(181)			5	8	8	6					
220pF(221)			5	8	8	6					
270pF(271)			5	8	8	6					
330pF(331)			5	8	8	6					
390pF(391)			5	8	8	6					
470pF(471)			5	8	8	6					
560pF(561)				8	8	6	6				
680pF(681)				8	8	6	6				
820pF(821)				8	8	6	6				
1000pF(102)				8	8	6	6				
1200pF(122)				8	8	6	6				
1500pF(152)				8	8	6	6				
1800pF(182)					8	6	6	9			
2200pF(222)					8	6	6	9			
2700pF(272)					8	6	6	9			
3300pF(332)					8	6	6	9			
3900pF(392)					8		6	9			
4700pF(472)							6	9	9		
5600pF(562)							9	9	9		
6800pF(682)							9	9	9		
8200pF(822)							9	9	9		
10000pF(103)							9	9	9		
12000pF(123)							9		9		
15000pF(153)							9		9		
18000pF(183)							B		9		
22000pF(223)							B		9		
27000pF(273)									9		
33000pF(333)									9		
39000pF(393)									9		
47000pF(473)									M		
56000pF(563)									M		

The part numbering code is shown in ( ) and Unit is shown in [ ]. < >: EIA [inch] Code



# Capacitance Table

## High Dielectric Constant Type X7R(R7)/X7S(C7)

6 ex.6: T Dimension Part Number Code

Capacitance	LxW [mm]	0.6x0.3 (03) <0201>			1.0x0.5 (15) <0402>			1.6x0.8 (18) <0603>					2.0x1.25 (21) <0805>						3.2x1.6 (31) <1206>						3.2x2.5 (32) <1210>								
		25 (1E)	16 (1C)	10 (1A)	100 (2A)	50 (1H)	25 (1E)	16 (1C)	100 (2A)	50 (1H)	25 (1E)	16 (1C)	6.3 (0J)	100 (2A)	50 (1H)	35 (YA)	25 (1E)	16 (1C)	10 (1A)	6.3 (0J)	100 (2A)	50 (1H)	25 (1E)	16 (1C)	10 (1A)	6.3 (0J)	100 (2A)	50 (1H)	25 (1E)	16 (1C)	10 (1A)	6.3 (0J)	
100pF(101)		3																															
150pF(151)		3																															
220pF(221)		3			5	5																											
330pF(331)		3			5	5																											
470pF(471)		3			5	5																											
680pF(681)		3			5	5																											
1000pF(102)		3			5	5		8	8																								
1500pF(152)		3			5	5		8	8																								
2200pF(222)		3	3		5	5		8	8																								
3300pF(332)		3	3		5	5		8	8																								
4700pF(472)				3	5	5		8	8																								
6800pF(682)				3		5		8	8				6																				
10000pF(103)				3		5	5	8	8				6																				
15000pF(153)						5	5	8	8				6																				
22000pF(223)						5	5	8	8				6																				
33000pF(333)							5	5	8	8				9	9																		
47000pF(473)							5	5	8	8				B	B																		
68000pF(683)								5	8	8				B	B																		
0.10μF(104)							5	8	8	8	8			B	B					9													
0.15μF(154)									8	8				B		B				M													
0.22μF(224)									8	8				B		B				M													
0.33μF(334)										8				9		B				M													
0.47μF(474)									8	8				B		9				M													
0.68μF(684)										8				B	B	9				M													
1.0μF(105)									8	8				B	B	9				M											E		
2.2μF(225)											8			B	B	B				C	M									D			
4.7μF(475)														B	B					C	C									E	D		
10μF(106)															B					C	C									E	D		
22μF(226)																					C									E	E		
47μF(476)																															E		

The part numbering code is shown in ( ) and Unit is shown in [ ]. < >: EIA [inch] Code

# Temperature Compensating Type

L x W [mm]		0.6x0.3(03)<0201>	1.0x0.5(15)<0402>	1.6x0.8(18)<0603>	
Rated Volt. [Vdc]		25(1E)	50(1H)	100(2A)	50(1H)
TC		COG(5C)			
Capacitance	Tolerance	Part Number			
1.0pF(1R0)	±0.25pF(C)	GCM0335C1E1R0CD03D	GCM1555C1H1R0CZ13D	GCM1885C2A1R0CZ13D	GCM1885C1H1R0CZ13D
2.0pF(2R0)	±0.25pF(C)	GCM0335C1E2R0CD03D	GCM1555C1H2R0CZ13D	GCM1885C2A2R0CZ13D	GCM1885C1H2R0CZ13D
3.0pF(3R0)	±0.25pF(C)	GCM0335C1E3R0CD03D	GCM1555C1H3R0CZ13D	GCM1885C2A3R0CZ13D	GCM1885C1H3R0CZ13D
4.0pF(4R0)	±0.25pF(C)	GCM0335C1E4R0CD03D	GCM1555C1H4R0CZ13D	GCM1885C2A4R0CZ13D	GCM1885C1H4R0CZ13D
5.0pF(5R0)	±0.25pF(C)	GCM0335C1E5R0CD03D	GCM1555C1H5R0CZ13D	GCM1885C2A5R0CZ13D	GCM1885C1H5R0CZ13D
6.0pF(6R0)	±0.5pF(D)	GCM0335C1E6R0DD03D	GCM1555C1H6R0DZ13D	GCM1885C2A6R0DZ13D	GCM1885C1H6R0DZ13D
7.0pF(7R0)	±0.5pF(D)	GCM0335C1E7R0DD03D	GCM1555C1H7R0DZ13D	GCM1885C2A7R0DZ13D	GCM1885C1H7R0DZ13D
8.0pF(8R0)	±0.5pF(D)	GCM0335C1E8R0DD03D	GCM1555C1H8R0DZ13D	GCM1885C2A8R0DZ13D	GCM1885C1H8R0DZ13D
9.0pF(9R0)	±0.5pF(D)	GCM0335C1E9R0DD03D	GCM1555C1H9R0DZ13D	GCM1885C2A9R0DZ13D	GCM1885C1H9R0DZ13D
10pF(100)	±5%(J)	GCM0335C1E100JD03D	GCM1555C1H100JZ13D	GCM1885C2A100JA16D	GCM1885C1H100JA16D
12pF(120)	±5%(J)	GCM0335C1E120JD03D	GCM1555C1H120JZ13D	GCM1885C2A120JA16D	GCM1885C1H120JA16D
15pF(150)	±5%(J)	GCM0335C1E150JD03D	GCM1555C1H150JZ13D	GCM1885C2A150JA16D	GCM1885C1H150JA16D
18pF(180)	±5%(J)	GCM0335C1E180JD03D	GCM1555C1H180JZ13D	GCM1885C2A180JA16D	GCM1885C1H180JA16D
22pF(220)	±5%(J)	GCM0335C1E220JD03D	GCM1555C1H220JZ13D	GCM1885C2A220JA16D	GCM1885C1H220JA16D
27pF(270)	±5%(J)	GCM0335C1E270JD03D	GCM1555C1H270JZ13D	GCM1885C2A270JA16D	GCM1885C1H270JA16D
33pF(330)	±5%(J)	GCM0335C1E330JD03D	GCM1555C1H330JZ13D	GCM1885C2A330JA16D	GCM1885C1H330JA16D
39pF(390)	±5%(J)	GCM0335C1E390JD03D	GCM1555C1H390JZ13D	GCM1885C2A390JA16D	GCM1885C1H390JA16D
47pF(470)	±5%(J)	GCM0335C1E470JD03D	GCM1555C1H470JZ13D	GCM1885C2A470JA16D	GCM1885C1H470JA16D
56pF(560)	±5%(J)	GCM0335C1E560JD03D	GCM1555C1H560JZ13D	GCM1885C2A560JA16D	GCM1885C1H560JA16D
68pF(680)	±5%(J)	GCM0335C1E680JD03D	GCM1555C1H680JZ13D	GCM1885C2A680JA16D	GCM1885C1H680JA16D
82pF(820)	±5%(J)	GCM0335C1E820JD03D	GCM1555C1H820JZ13D	GCM1885C2A820JA16D	GCM1885C1H820JA16D
100pF(101)	±5%(J)	GCM0335C1E101JD03D	GCM1555C1H101JZ13D	GCM1885C2A101JA16D	GCM1885C1H101JA16D
120pF(121)	±5%(J)		GCM1555C1H121JA16D	GCM1885C2A121JA16D	GCM1885C1H121JA16D
150pF(151)	±5%(J)		GCM1555C1H151JA16D	GCM1885C2A151JA16D	GCM1885C1H151JA16D
180pF(181)	±5%(J)		GCM1555C1H181JA16D	GCM1885C2A181JA16D	GCM1885C1H181JA16D
220pF(221)	±5%(J)		GCM1555C1H221JA16D	GCM1885C2A221JA16D	GCM1885C1H221JA16D
270pF(271)	±5%(J)		GCM1555C1H271JA16D	GCM1885C2A271JA16D	GCM1885C1H271JA16D
330pF(331)	±5%(J)		GCM1555C1H331JA16D	GCM1885C2A331JA16D	GCM1885C1H331JA16D
390pF(391)	±5%(J)		GCM1555C1H391JA16D	GCM1885C2A391JA16D	GCM1885C1H391JA16D
470pF(471)	±5%(J)		GCM1555C1H471JA16D	GCM1885C2A471JA16D	GCM1885C1H471JA16D
560pF(561)	±5%(J)			GCM1885C2A561JA16D	GCM1885C1H561JA16D
680pF(681)	±5%(J)			GCM1885C2A681JA16D	GCM1885C1H681JA16D
820pF(821)	±5%(J)			GCM1885C2A821JA16D	GCM1885C1H821JA16D
1000pF(102)	±5%(J)			GCM1885C2A102JA16D	GCM1885C1H102JA16D
1200pF(122)	±5%(J)			GCM1885C2A122JA16D	GCM1885C1H122JA16D
1500pF(152)	±5%(J)			GCM1885C2A152JA16D	GCM1885C1H152JA16D
1800pF(182)	±5%(J)				GCM1885C1H182JA16D
2200pF(222)	±5%(J)				GCM1885C1H222JA16D
2700pF(272)	±5%(J)				GCM1885C1H272JA16D
3300pF(332)	±5%(J)				GCM1885C1H332JA16D
3900pF(392)	±5%(J)				GCM1885C1H392JA16D

The part numbering code is shown in ( ) and Unit is shown in [ ]. < >: EIA [inch] Code

(Part Number) **GC** **M** **03** **3** **5C** **1E** **1R0** **C** **D03** **D**    ①Product ID    ②Series    ③Dimension (L×W)    ④Dimension (T)  
 ⑤Temperature Characteristics    ⑥Rated Voltage    ⑦Capacitance  
 ⑧Capacitance Tolerance    ⑨Individual Specification Code    ⑩Package

Packaging Code in Part Number is a code shows STD 180mm Reel Taping.

## Temperature Compensating Type

L x W [mm]		2.0x1.25(21)<0805>		3.2x1.6(31)<1206>	
Rated Volt. [Vdc]		100(2A)	50(1H)	100(2A)	50(1H)
TC		COG(5C)			
Capacitance	Tolerance	Part Number			
100pF(101)	±5%(J)	GCM2165C2A101JA16D			
120pF(121)	±5%(J)	GCM2165C2A121JA16D			
150pF(151)	±5%(J)	GCM2165C2A151JA16D			
180pF(181)	±5%(J)	GCM2165C2A181JA16D			
220pF(221)	±5%(J)	GCM2165C2A221JA16D			
270pF(271)	±5%(J)	GCM2165C2A271JA16D			
330pF(331)	±5%(J)	GCM2165C2A331JA16D			
390pF(391)	±5%(J)	GCM2165C2A391JA16D			
470pF(471)	±5%(J)	GCM2165C2A471JA16D			
560pF(561)	±5%(J)	GCM2165C2A561JA16D	GCM2165C1H561JA16D		
680pF(681)	±5%(J)	GCM2165C2A681JA16D	GCM2165C1H681JA16D		
820pF(821)	±5%(J)	GCM2165C2A821JA16D	GCM2165C1H821JA16D		
1000pF(102)	±5%(J)	GCM2165C2A102JA16D	GCM2165C1H102JA16D		
1200pF(122)	±5%(J)	GCM2165C2A122JA16D	GCM2165C1H122JA16D		
1500pF(152)	±5%(J)	GCM2165C2A152JA16D	GCM2165C1H152JA16D		
1800pF(182)	±5%(J)	GCM2165C2A182JA16D	GCM2165C1H182JA16D	GCM3195C2A182JA16D	
2200pF(222)	±5%(J)	GCM2165C2A222JA16D	GCM2165C1H222JA16D	GCM3195C2A222JA16D	
2700pF(272)	±5%(J)	GCM2165C2A272JA16D	GCM2165C1H272JA16D	GCM3195C2A272JA16D	
3300pF(332)	±5%(J)	GCM2165C2A332JA16D	GCM2165C1H332JA16D	GCM3195C2A332JA16D	
3900pF(392)	±5%(J)		GCM2165C1H392JA16D	GCM3195C2A392JA16D	
4700pF(472)	±5%(J)		GCM2165C1H472JA16D	GCM3195C2A472JA16D	GCM3195C1H472JA16D
5600pF(562)	±5%(J)		GCM2195C1H562JA16D	GCM3195C2A562JA16D	GCM3195C1H562JA16D
6800pF(682)	±5%(J)		GCM2195C1H682JA16D	GCM3195C2A682JA16D	GCM3195C1H682JA16D
8200pF(822)	±5%(J)		GCM2195C1H822JA16D	GCM3195C2A822JA16D	GCM3195C1H822JA16D
10000pF(103)	±5%(J)		GCM2195C1H103JA16D	GCM3195C2A103JA16D	GCM3195C1H103JA16D
12000pF(123)	±5%(J)		GCM2195C1H123JA16D		GCM3195C1H123JA16D
15000pF(153)	±5%(J)		GCM2195C1H153JA16D		GCM3195C1H153JA16D
18000pF(183)	±5%(J)		GCM21B5C1H183JA16L		GCM3195C1H183JA16D
22000pF(223)	±5%(J)		GCM21B5C1H223JA16L		GCM3195C1H223JA16D
27000pF(273)	±5%(J)				GCM3195C1H273JA16D
33000pF(333)	±5%(J)				GCM3195C1H333JA16D
39000pF(393)	±5%(J)				GCM3195C1H393JA16D
47000pF(473)	±5%(J)				GCM31M5C1H473JA16L
56000pF(563)	±5%(J)				GCM31M5C1H563JA16L

The part numbering code is shown in ( ) and Unit is shown in [ ]. < >: EIA [inch] Code

## High Dielectric Constant Type

L x W [mm]		0.6x0.3(03)<0201>		
Rated Volt. [Vdc]		25(1E)	16(1C)	10(1A)
TC		X7R(R7)		
Capacitance	Tolerance	Part Number		
100pF(101)	±10%(K)	GCM033R71E101KA03D		
150pF(151)	±10%(K)	GCM033R71E151KA03D		
220pF(221)	±10%(K)	GCM033R71E221KA03D		
330pF(331)	±10%(K)	GCM033R71E331KA03D		
470pF(471)	±10%(K)	GCM033R71E471KA03D		
680pF(681)	±10%(K)	GCM033R71E681KA03D		
1000pF(102)	±10%(K)	GCM033R71E102KA03D		
1500pF(152)	±10%(K)	GCM033R71E152KA03D		
2200pF(222)	±10%(K)		GCM033R71C222KA55D	
3300pF(332)	±10%(K)		GCM033R71C332KA55D	
4700pF(472)	±10%(K)			GCM033R71A472KA03D
6800pF(682)	±10%(K)			GCM033R71A682KA03D
10000pF(103)	±10%(K)			GCM033R71A103KA03D

L x W [mm]		1.0x0.5(15)<0402>			
Rated Volt. [Vdc]		100(2A)	50(1H)	25(1E)	16(1C)
TC		X7R(R7)			
Capacitance	Tolerance	Part Number			
220pF(221)	±10%(K)	GCM155R72A221KA37D	GCM155R71H221KA37D		
330pF(331)	±10%(K)	GCM155R72A331KA37D	GCM155R71H331KA37D		
470pF(471)	±10%(K)	GCM155R72A471KA37D	GCM155R71H471KA37D		
680pF(681)	±10%(K)	GCM155R72A681KA37D	GCM155R71H681KA37D		
1000pF(102)	±10%(K)	GCM155R72A102KA37D	GCM155R71H102KA37D		
1500pF(152)	±10%(K)	GCM155R72A152KA37D	GCM155R71H152KA37D		
2200pF(222)	±10%(K)	GCM155R72A222KA37D	GCM155R71H222KA37D		
3300pF(332)	±10%(K)	GCM155R72A332KA37D	GCM155R71H332KA37D		
4700pF(472)	±10%(K)	GCM155R72A472KA37D	GCM155R71H472KA37D		
6800pF(682)	±10%(K)		GCM155R71H682KA55D		
10000pF(103)	±10%(K)		GCM155R71H103KA55D	GCM155R71E103KA37D	
15000pF(153)	±10%(K)		GCM155R71H153KA55D	GCM155R71E153KA55D	
22000pF(223)	±10%(K)		GCM155R71H223KA55D	GCM155R71E223KA55D	
33000pF(333)	±10%(K)			GCM155R71E333KA55D	GCM155R71C333KA37D
47000pF(473)	±10%(K)			GCM155R71E473KA55D	GCM155R71C473KA37D
68000pF(683)	±10%(K)				GCM155R71C683KA55D
0.10μF(104)	±10%(K)				GCM155R71C104KA55D

The part numbering code is shown in ( ) and Unit is shown in [ ]. < >: EIA [inch] Code

(Part Number) **GC** **M** **03** **3** **R7** **1E** **101** **K** **A03** **D** ①Product ID ②Series ③Dimension (L×W) ④Dimension (T)  
 ⑤Temperature Characteristics ⑥Rated Voltage ⑦Capacitance  
 ⑧Capacitance Tolerance ⑨Individual Specification Code ⑩Package

Packaging Code in Part Number is a code shows STD 180mm Reel Taping.

## High Dielectric Constant Type

L x W [mm]		1.6x0.8(18)<0603>			
Rated Volt. [Vdc]		100(2A)	50(1H)	25(1E)	16(1C)
TC		X7R(R7)/X7S(C7)			
Capacitance	Tolerance	Part Number			
1000pF(102)	±10%(K)	GCM188R72A102KA37D	GCM188R71H102KA37D		
1500pF(152)	±10%(K)	GCM188R72A152KA37D	GCM188R71H152KA37D		
2200pF(222)	±10%(K)	GCM188R72A222KA37D	GCM188R71H222KA37D		
3300pF(332)	±10%(K)	GCM188R72A332KA37D	GCM188R71H332KA37D		
4700pF(472)	±10%(K)	GCM188R72A472KA37D	GCM188R71H472KA37D		
6800pF(682)	±10%(K)	GCM188R72A682KA37D	GCM188R71H682KA37D		
10000pF(103)	±10%(K)	GCM188R72A103KA37D	GCM188R71H103KA37D		
15000pF(153)	±10%(K)	GCM188R72A153KA37D	GCM188R71H153KA37D		
22000pF(223)	±10%(K)	GCM188R72A223KA37D	GCM188R71H223KA37D		
33000pF(333)	±10%(K)		GCM188R71H333KA55D	GCM188R71E333KA37D	
47000pF(473)	±10%(K)		GCM188R71H473KA55D	GCM188R71E473KA37D	
68000pF(683)	±10%(K)		GCM188R71H683KA57D	GCM188R71E683KA57D	
0.10μF(104)	±10%(K)	GCM188R72A104KA64D	GCM188R71H104KA57D	GCM188R71E104KA57D	GCM188R71C104KA37D
0.15μF(154)	±10%(K)		GCM188R71H154KA64D	GCM188R71E154KA37D	
0.22μF(224)	±10%(K)		GCM188R71H224KA64D	GCM188R71E224KA55D	
0.33μF(334)	±10%(K)				GCM188R71C334KA37D
0.47μF(474)	±10%(K)			GCM188R71E474KA64D	GCM188R71C474KA55D
1.0μF(105)	±10%(K)			GCM188R71E105KA64D	GCM188R71C105KA64D

L x W [mm]		1.6x0.8(18)<0603>
Rated Volt. [Vdc]		6.3(0J)
TC		X7R(R7)
Capacitance	Tolerance	Part Number
2.2μF(225)	±10%(K)	GCM188R70J225KE22D

The part numbering code is shown in ( ) and Unit is shown in [ ]. < >: EIA [inch] Code

## High Dielectric Constant Type

L x W [mm]		2.0x1.25(21)<0805>			
Rated Volt. [Vdc]		100(2A)	50(1H)	35(YA)	25(1E)
TC		X7R(R7)			
Capacitance	Tolerance	Part Number			
6800pF(682)	±10%(K)	GCM216R72A682KA37D			
10000pF(103)	±10%(K)	GCM216R72A103KA37D			
15000pF(153)	±10%(K)	GCM216R72A153KA37D			
22000pF(223)	±10%(K)	GCM216R72A223KA37D			
33000pF(333)	±10%(K)	GCM219R72A333KA37D	GCM219R71H333KA37D		
47000pF(473)	±10%(K)	GCM21BR72A473KA37L	GCM21BR71H473KA37L		
68000pF(683)	±10%(K)	GCM21BR72A683KA37L	GCM21BR71H683KA37L		
0.10μF(104)	±10%(K)	GCM21BR72A104KA37L	GCM21BR71H104KA37L		
0.15μF(154)	±10%(K)		GCM21BR71H154KA37L		GCM21BR71E154KA37L
0.22μF(224)	±10%(K)		GCM21BR71H224KA37L		GCM21BR71E224KA37L
0.33μF(334)	±10%(K)		GCM219R71H334KA55D		GCM21BR71E334KA37L
0.47μF(474)	±10%(K)		GCM21BR71H474KA55L		GCM219R71E474KA55D
0.68μF(684)	±10%(K)			GCM21BR7YA684KA55L	GCM21BR71E684KA55L
1.0μF(105)	±10%(K)			GCM21BR7YA105KA55L	GCM21BR71E105KA56L
2.2μF(225)	±10%(K)				GCM21BR71E225KA73L

L x W [mm]		2.0x1.25(21)<0805>		
Rated Volt. [Vdc]		16(1C)	10(1A)	6.3(0J)
TC		X7R(R7)/X7S(C7)		
Capacitance	Tolerance	Part Number		
0.68μF(684)	±10%(K)	GCM219R71C684KA37D		
1.0μF(105)	±10%(K)	GCM219R71C105KA37D		
2.2μF(225)	±10%(K)	GCM21BR71C225KA64L	GCM21BR71A225KA37L	
4.7μF(475)	±10%(K)	GCM21BR71C475KA73L	GCM21BC71A475KA73L	
10μF(106)	±10%(K)			GCM21BR70J106KE22L

L x W [mm]		3.2x1.6(31)<1206>			
Rated Volt. [Vdc]		100(2A)	50(1H)	25(1E)	16(1C)
TC		X7R(R7)			
Capacitance	Tolerance	Part Number			
0.10μF(104)	±10%(K)	GCM319R72A104KA37D			
0.15μF(154)	±10%(K)	GCM31MR72A154KA37L			
0.22μF(224)	±10%(K)	GCM31MR72A224KA37L			
0.33μF(334)	±10%(K)		GCM31MR71H334KA37L		
0.47μF(474)	±10%(K)		GCM31MR71H474KA37L		
0.68μF(684)	±10%(K)		GCM31MR71H684KA55L		
1.0μF(105)	±10%(K)		GCM31MR71H105KA55L		
2.2μF(225)	±10%(K)		GCM31CR71H225KA55L	GCM31MR71E225KA57L	
4.7μF(475)	±10%(K)			GCM31CR71E475KA55L	GCM31CR71C475KA37L
10μF(106)	±10%(K)				GCM31CR71C106KA64L

L x W [mm]		3.2x1.6(31)<1206>	
Rated Volt. [Vdc]		10(1A)	6.3(0J)
TC		X7R(R7)	
Capacitance	Tolerance	Part Number	
10μF(106)	±10%(K)	GCM31CR71A106KA64L	
22μF(226)	±20%(M)		GCM31CR70J226ME23L

The part numbering code is shown in ( ) and Unit is shown in [ ]. < >: EIA [inch] Code

(Part Number) **GC** **M** **21** **6** **R7** **2A** **682** **K** **A37** **D** **1** **2** **3** **4** **5** **6** **7** **8** **9** **10**

① Product ID      ② Series      ③ Dimension (L×W)      ④ Dimension (T)  
 ⑤ Temperature Characteristics      ⑥ Rated Voltage      ⑦ Capacitance  
 ⑧ Capacitance Tolerance      ⑨ Individual Specification Code      ⑩ Package

Packaging Code in Part Number is a code shows STD 180mm Reel Taping.

## High Dielectric Constant Type

L x W [mm]		3.2x2.5(32)<1210>			
Rated Volt. [Vdc]		100(2A)	50(1H)	25(1E)	16(1C)
TC		X7R(R7)			
Capacitance	Tolerance	Part Number			
1.0μF(105)	±10%(K)		GCM32ER71H105KA37L		
2.2μF(225)	±10%(K)	GCM32DR72A225KA64L			
4.7μF(475)	±10%(K)		GCM32ER71H475KA55L	GCM32DR71E475KA55L	
10μF(106)	±10%(K)			GCM32ER71E106KA57L	GCM32DR71C106KA37L
22μF(226)	±20%(M)				GCM32ER71C226ME19L

L x W [mm]		3.2x2.5(32)<1210>			
Rated Volt. [Vdc]		10(1A)	6.3(0J)		
TC		X7R(R7)			
Capacitance	Tolerance	Part Number			
22μF(226)	±20%(M)	GCM32ER71A226ME12L			
47μF(476)	±20%(M)		GCM32ER70J476ME19L		

The part numbering code is shown in ( ) and Unit is shown in [ ]. < >: EIA [inch] Code

# Specifications and Test Methods

No.	AEC-Q200 Test Item	Specifications		AEC-Q200 Test Method															
		Temperature Compensating Type	High Dielectric Type																
1	Pre-and Post-Stress Electrical Test	-																	
2	High Temperature Exposure (Storage)	The measured and observed characteristics should satisfy the specifications in the following table.		Sit the capacitor for 1000±12 hours at 150±3°C. Let sit for 24±2 hours at room temperature, then measure.															
	Appearance	No marking defects																	
	Capacitance Change	Within ±2.5% or ±0.25pF (Whichever is larger)	Within ±10.0%																
	Q/D.F.	30pFmin.: Q≥1000 30pFmax.: Q≥400+20C C: Nominal Capacitance (pF)	W.V.: 25Vmin.: 0.03 max. W.V.: 16V: 0.05 max.																
3	Temperature Cycle	The measured and observed characteristics should satisfy the specifications in the following table.		Fix the capacitor to the supporting jig in the same manner and under the same conditions as (18). Perform the 1000 cycles according to the four heat treatments listed in the following table. Let sit for 24±2 hours at room temperature, then measure <table border="1" style="margin: 10px auto;"> <thead> <tr> <th>Step</th> <th>1</th> <th>2</th> <th>3</th> <th>4</th> </tr> </thead> <tbody> <tr> <td>Temp. (°C)</td> <td>-55+0/-3</td> <td>Room Temp.</td> <td>125+3/-0 (ΔC/R7/C7)</td> <td>Room Temp.</td> </tr> <tr> <td>Time (min.)</td> <td>15±3</td> <td>1</td> <td>15±3</td> <td>1</td> </tr> </tbody> </table> • Initial measurement for high dielectric constant type Perform a heat treatment at 150±3°C for one hour and then let sit for 24±2 hours at room temperature. Perform the initial measurement.	Step	1	2	3	4	Temp. (°C)	-55+0/-3	Room Temp.	125+3/-0 (ΔC/R7/C7)	Room Temp.	Time (min.)	15±3	1	15±3	1
	Step	1	2		3	4													
	Temp. (°C)	-55+0/-3	Room Temp.		125+3/-0 (ΔC/R7/C7)	Room Temp.													
	Time (min.)	15±3	1		15±3	1													
Appearance	No marking defects																		
Capacitance Change	Within ±2.5% or ±0.25pF (Whichever is larger)	Within ±10.0%																	
Q/D.F.	30pFmin.: Q≥1000 30pFmax.: Q≥400+20C C: Nominal Capacitance (pF)	W.V.: 25Vmin.: 0.03 max. W.V.: 16V: 0.05 max.																	
I.R.	More than 10,000MΩ or 500Ω · F (Whichever is smaller)		*1																
4	Destructive Physical Analysis	No defects or abnormalities		Per EIA-469															
5	Moisture Resistance	The measured and observed characteristics should satisfy the specifications in the following table.		Apply the 24-hour heat (25 to 65°C) and humidity (80 to 98%) treatment shown below, 10 consecutive times. Let sit for 24±2 hours at room temperature, then measure. <div style="text-align: center;"> <p>Temperature (°C) vs. Hours (0-24). Humidity 90-98% during high temperature segments. Initial measurement at 20°C.</p> </div>															
	Appearance	No marking defects																	
	Capacitance Change	Within ±3.0% or ±0.30pF (Whichever is larger)	Within ±12.5%																
	Q/D.F.	30pFmin.: Q≥350 10pF and over, 30pF and below: Q≥275+ $\frac{2}{3}$ C 10pFmax.: Q≥200+10C C: Nominal Capacitance (pF)	W.V.: 25Vmin.: 0.03 max. W.V.: 16V: 0.05 max.																
I.R.	More than 10,000MΩ or 500Ω · F (Whichever is smaller)		*1																
6	Biased Humidity	The measured and observed characteristics should satisfy the specifications in the following table.		Apply the rated voltage and 1.3+0.2/-0Vdc (add 6.8k Ω resistor) at 85±3°C and 80 to 85% humidity for 1000±12 hours. Remove and let sit for 24±2 hours at room temperature, then measure. The charge/discharge current is less than 50mA.															
	Appearance	No marking defects																	
	Capacitance Change	Within ±3.0% or ±0.30pF (Whichever is larger)	Within ±12.5%																
	Q/D.F.	30pF and over: Q≥200 30pF and below: Q≥100+ $\frac{10}{3}$ C C: Nominal Capacitance (pF)	W.V.: 25Vmin.: 0.035 max. W.V.: 16V: 0.05 max.																
I.R.	More than 1,000MΩ or 50Ω · F (Whichever is smaller)		*1																

\*1: The figure indicates typical specification. Please refer to individual specifications.



# Specifications and Test Methods

Continued from the preceding page.

No.	AEC-Q200 Test Item	Specifications		AEC-Q200 Test Method	
		Temperature Compensating Type	High Dielectric Type		
7	Operational Life	The measured and observed characteristics should satisfy the specifications in the following table.		Apply 200% of the rated voltage for 1000±12 hours at 125±3°C. Let sit for 24±2 hours at room temperature, then measure. *2 The charge/discharge current is less than 50mA.  • Initial measurement for high dielectric constant type. Apply 200% of the rated DC voltage for one hour at the maximum operating temperature ±3°C. Remove and let sit for 24±2 hours at room temperature. Perform initial measurement. *2	
	Appearance	No marking defects			
	Capacitance Change	Within ±3.0% or ±0.30pF (Whichever is larger)	Within ±12.5%		
	Q/D.F.	30pFmin.: Q≥350 10pF and over, 30pF and below: Q≥275+ $\frac{C}{10}$ 10pFmax.: Q≥200+10C C: Nominal Capacitance (pF)	W.V.: 25Vmin.: 0.035 max. W.V.: 16V: 0.05 max.		
I.R.	More than 1,000MΩ or 50Ω · F (Whichever is smaller) *1				
8	External Visual	No defects or abnormalities		Visual inspection	
9	Physical Dimension	Within the specified dimensions		Using calipers	
10	Resistance to Solvents	Appearance	No marking defects		Per MIL-STD-202 Method 215 Solvent 1: 1 part (by volume) of isopropyl alcohol 3 parts (by volume) of mineral spirits Solvent 2: Terpene defluxer Solvent 3: 42 parts (by volume) of water 1 part (by volume) of propylene glycol monomethyl ether 1 part (by volume) of monoethanolamine
		Capacitance Change	Within the specified tolerance		
		Q/D.F.	30pFmin.: Q≥1000 30pFmax.: Q≥400+20C C: Nominal Capacitance (pF)	W.V.: 25Vmin.: 0.025 max. W.V.: 16V: 0.035 max.	
		I.R.	More than 10,000MΩ or 500Ω · F (Whichever is smaller) *1		
11	Mechanical Shock	Appearance	No marking defects		Three shocks in each direction should be applied along 3 mutually perpendicular axes of the test specimen (18 shocks). The specified test pulse should be Half-sine and should have a duration: 0.5ms, peak value: 1500g and velocity change: 4.7m/s.
		Capacitance Change	Within the specified tolerance		
		Q/D.F.	30pFmin.: Q≥1000 30pFmax.: Q≥400+20C C: Nominal Capacitance (pF)	W.V.: 25Vmin.: 0.025 max. W.V.: 16V: 0.035 max.	
		I.R.	More than 10,000MΩ or 500Ω · F (Whichever is smaller) *1		
12	Vibration	Appearance	No defects or abnormalities		Solder the capacitor to the test jig (glass epoxy board) in the same manner and under the same conditions as (19). The capacitor should be subjected to a simple harmonic motion having a total amplitude of 1.5mm, the frequency being varied uniformly between the approximate limits of 10 and 2000Hz. The frequency range, from 10 to 2000Hz and return to 10Hz, should be traversed in approximately 20 minutes. This motion should be applied for 12 items in each 3 mutually perpendicular directions (total of 36 times).
		Capacitance Change	Within the specified tolerance		
		Q/D.F.	30pFmin.: Q≥1000 30pFmax.: Q≥400+20C C: Nominal Capacitance (pF)	W.V.: 25Vmin.: 0.025 max. W.V.: 16V: 0.035 max.	
		I.R.	More than 10,000MΩ or 500Ω · F (Whichever is smaller) *1		
13	Resistance to Soldering Heat	The measured and observed characteristics should satisfy the specifications in the following table.		Immerse the capacitor in a eutectic solder solution at 260±5°C for 10±1 seconds. Let sit at room temperature for 24±2 hours, then measure.  • Initial measurement for high dielectric constant type Perform a heat treatment at 150±5°C for one hour and then let sit for 24±2 hours at room temperature. Perform the initial measurement.	
	Appearance	No marking defects			
	Capacitance Change	Within the specified tolerance			
	Q/D.F.	30pFmin.: Q≥1000 30pFmax.: Q≥400+20C C: Nominal Capacitance (pF)	W.V.: 25Vmin.: 0.025 max. W.V.: 16V: 0.035 max.		
I.R.	More than 10,000MΩ or 500Ω · F (Whichever is smaller) *1				

\*1: The figure indicates typical specification. Please refer to individual specifications.

\*2: Some of the parts are applicable in rated voltage x 150%. Please refer to individual specifications.

Continued on the following page.

# Specifications and Test Methods

Continued from the preceding page.

No.	AEC-Q200 Test Item	Specifications		AEC-Q200 Test Method																									
		Temperature Compensating Type	High Dielectric Type																										
14	Thermal Shock	The measured and observed characteristics should satisfy the specifications in the following table.		Fix the capacitor to the supporting jig in the same manner and under the same conditions as (18). Perform the 300 cycles according to the two heat treatments listed in the following table (Maximum transfer time is 20 seconds). Let sit for 24±2 hours at room temperature, then measure. <table border="1" style="margin: 10px auto; border-collapse: collapse;"> <thead> <tr> <th>Step</th> <th>1</th> <th>2</th> </tr> </thead> <tbody> <tr> <td>Temp. (°C)</td> <td>-55+0/-3</td> <td>125+3/-0 (5C, C7, R7)</td> </tr> <tr> <td>Time (min.)</td> <td>15±3</td> <td>15±3</td> </tr> </tbody> </table> <ul style="list-style-type: none"> <li>Initial measurement for high dielectric constant type</li> </ul> Perform a heat treatment at 150 <sup>+0</sup> / <sub>-0</sub> °C for one hour and then let sit for 24±2 hours at room temperature. Perform the initial measurement.	Step	1	2	Temp. (°C)	-55+0/-3	125+3/-0 (5C, C7, R7)	Time (min.)	15±3	15±3																
		Step	1		2																								
		Temp. (°C)	-55+0/-3		125+3/-0 (5C, C7, R7)																								
		Time (min.)	15±3		15±3																								
Appearance	No marking defects																												
Capacitance Change	Within ±2.5% or ±0.25pF (Whichever is larger)	Within ±10.0%																											
Q/D.F.	30pF min.: Q≥1000 30pF max.: Q≥400+20C C: Nominal Capacitance (pF)	W.V.: 25Vmin.: 0.025 max. W.V.: 16V: 0.035 max. *1																											
I.R.	More than 10,000MΩ or 500Ω · F (Whichever is smaller) *1																												
15	ESD	Appearance	No marking defects		Per AEC-Q200-002																								
		Capacitance Change	Within the specified tolerance																										
		Q/D.F.	30pF min.: Q≥1000 30pF max.: Q≥400+20C C: Nominal Capacitance (pF)	W.V.: 25Vmin.: 0.025 max. W.V.: 16V: 0.035 max. *1																									
		I.R.	More than 10,000MΩ or 500Ω · F (Whichever is smaller) *1																										
16	Solderability	95% of the terminations is to be soldered evenly and continuously.		(a) Preheat at 155°C for 4 hours. After preheating, immerse the capacitor in a solution of ethanol (JIS-K-8101) and rosin (JIS-K-5902) (25% rosin in weight proportion). Immerse in eutectic solder solution for 5+0/-0.5 seconds at 235±5°C.																									
				(b) Should be placed into steam aging for 8 hours±15 minutes. After preheating, immerse the capacitor in a solution of ethanol (JIS-K-8101) and rosin (JIS-K-5902) (25% rosin in weight proportion). Immerse in eutectic solder solution for 5+0/-0.5 seconds at 235±5°C.																									
				(c) Should be placed into steam aging for 8 hours±15 minutes. After preheating, immerse the capacitor in a solution of ethanol (JIS-K-8101) and rosin (JIS-K-5902) (25% rosin in weight proportion). Immerse in eutectic solder solution for 120 ±5 seconds at 260±5°C.																									
17	Electrical Characterization	Appearance	No defects or abnormalities		Visual inspection.																								
		Capacitance Change	Within the specified tolerance		The capacitance/Q/D.F. should be measured at 25°C at the frequency and voltage shown in the table. <table border="1" style="margin: 10px auto; border-collapse: collapse;"> <thead> <tr> <th colspan="3">(1) Temperature Compensating Type</th> </tr> <tr> <th>Capacitance</th> <th>Frequency</th> <th>Voltage</th> </tr> </thead> <tbody> <tr> <td>C≤1000pF</td> <td>1±0.1MHz</td> <td>0.5 to 5Vrms</td> </tr> <tr> <td>C&gt;1000pF</td> <td>1±0.1kHz</td> <td>1±0.2Vrms</td> </tr> </tbody> </table> <table border="1" style="margin: 10px auto; border-collapse: collapse;"> <thead> <tr> <th colspan="3">(2) High Dielectric Type</th> </tr> <tr> <th>Capacitance</th> <th>Frequency</th> <th>Voltage</th> </tr> </thead> <tbody> <tr> <td>C≤10μF</td> <td>1±0.1kHz</td> <td>1±0.2Vrms</td> </tr> <tr> <td>C&gt;10μF</td> <td>120±24Hz</td> <td>0.5±0.1Vrms</td> </tr> </tbody> </table>	(1) Temperature Compensating Type			Capacitance	Frequency	Voltage	C≤1000pF	1±0.1MHz	0.5 to 5Vrms	C>1000pF	1±0.1kHz	1±0.2Vrms	(2) High Dielectric Type			Capacitance	Frequency	Voltage	C≤10μF	1±0.1kHz	1±0.2Vrms	C>10μF	120±24Hz	0.5±0.1Vrms
		(1) Temperature Compensating Type																											
		Capacitance	Frequency	Voltage																									
C≤1000pF	1±0.1MHz	0.5 to 5Vrms																											
C>1000pF	1±0.1kHz	1±0.2Vrms																											
(2) High Dielectric Type																													
Capacitance	Frequency	Voltage																											
C≤10μF	1±0.1kHz	1±0.2Vrms																											
C>10μF	120±24Hz	0.5±0.1Vrms																											
Q/D.F.	30pF min.: Q≥1000 30pF max.: Q≥400+20C C: Nominal Capacitance (pF)	W.V.: 25V min.: 0.025 max. W.V.: 16V: 0.035 max *1																											
I.R.	25°C More than 100,000MΩ or 1,000Ω · F (Whichever is smaller)	25°C More than 10,000MΩ or 500Ω · F (Whichever is smaller)	The insulation resistance should be measured with a DC voltage not exceeding the rated voltage at 25°C and 125°C and within 2 minutes of charging.																										
	Max. Operating Temperature--125°C More than 10,000MΩ or 100Ω · F (Whichever is smaller)	Max. Operating Temperature--125°C More than 1,000MΩ or 10Ω · F (Whichever is smaller)																											
Dielectric Strength	No failure		No failure should be observed when 250% of the rated voltage is applied between the terminations for 1 to 5 seconds, provided the charge/discharge current is less than 50mA.																										

\*1: The figure indicates typical specification. Please refer to individual specifications.

Continued on the following page.

# Specifications and Test Methods

Continued from the preceding page.

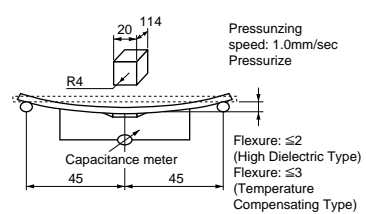
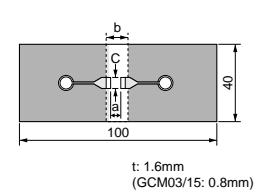
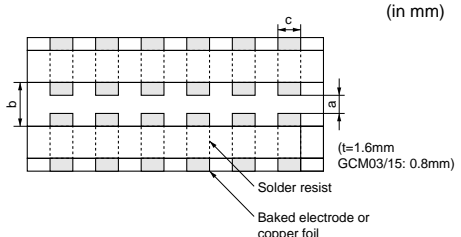
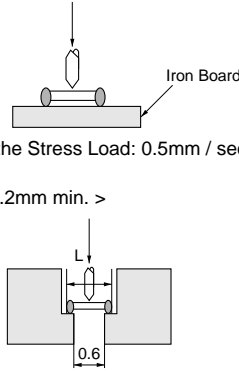
No.	AEC-Q200 Test Item	Specifications		AEC-Q200 Test Method																													
		Temperature Compensating Type	High Dielectric Type																														
18	Board Flex	Appearance	No marking defects		Solder the capacitor on the test jig (glass epoxy board) shown in Fig. 1 using a eutectic solder. Then apply a force in the direction shown in Fig. 2 for 5±1sec. The soldering should be done by the reflow method and should be conducted with care so that the soldering is uniform and free of defects such as heat shock. <table border="1" style="margin-top: 10px;"> <thead> <tr> <th>Type</th> <th>a</th> <th>b</th> <th>c</th> </tr> </thead> <tbody> <tr> <td>GCM03</td> <td>0.3</td> <td>0.9</td> <td>0.3</td> </tr> <tr> <td>GCM15</td> <td>0.5</td> <td>1.5</td> <td>0.6</td> </tr> <tr> <td>GCM18</td> <td>0.6</td> <td>2.2</td> <td>0.9</td> </tr> <tr> <td>GCM21</td> <td>0.8</td> <td>3.0</td> <td>1.3</td> </tr> <tr> <td>GCM31</td> <td>2.0</td> <td>4.4</td> <td>1.7</td> </tr> <tr> <td>GCM32</td> <td>2.0</td> <td>4.4</td> <td>2.6</td> </tr> </tbody> </table> <div style="text-align: right; margin-top: 5px;">(in mm)</div> 	Type	a	b	c	GCM03	0.3	0.9	0.3	GCM15	0.5	1.5	0.6	GCM18	0.6	2.2	0.9	GCM21	0.8	3.0	1.3	GCM31	2.0	4.4	1.7	GCM32	2.0	4.4	2.6
		Type	a	b		c																											
		GCM03	0.3	0.9		0.3																											
		GCM15	0.5	1.5		0.6																											
GCM18	0.6	2.2	0.9																														
GCM21	0.8	3.0	1.3																														
GCM31	2.0	4.4	1.7																														
GCM32	2.0	4.4	2.6																														
Capacitance Change	Within ±5.0% or ±0.5pF (Whichever is larger)	Within ±10.0%																															
Q/D.F.	30pF min.: Q≥1000 30pF max.: Q≥400+20C C: Nominal Capacitance (pF)	W.V.: 25Vmin.: 0.025 max. W.V.: 16V: 0.035 max. *1																															
I.R.	More than 10,000MΩ or 500Ω · F (Whichever is smaller) *1	 <p style="text-align: center;">t: 1.6mm (GCM03/15: 0.8mm) Fig. 1</p>																															
19	Terminal Strength	Appearance	No marking defects		Solder the capacitor to the test jig (glass epoxy board) shown in Fig. 3 using a eutectic solder. Then apply *18N force in parallel with the test jig for 60sec. The soldering should be done either with an iron or using the reflow method and should be conducted with care so that the soldering is uniform and free of defects such as heat shock. *2N (GCM03/15) <table border="1" style="margin-top: 10px;"> <thead> <tr> <th>Type</th> <th>a</th> <th>b</th> <th>c</th> </tr> </thead> <tbody> <tr> <td>GCM03</td> <td>0.3</td> <td>0.9</td> <td>0.3</td> </tr> <tr> <td>GCM15</td> <td>0.4</td> <td>1.5</td> <td>0.5</td> </tr> <tr> <td>GCM18</td> <td>1.0</td> <td>3.0</td> <td>1.2</td> </tr> <tr> <td>GCM21</td> <td>1.2</td> <td>4.0</td> <td>1.65</td> </tr> <tr> <td>GCM31</td> <td>2.2</td> <td>5.0</td> <td>2.0</td> </tr> <tr> <td>GCM32</td> <td>2.2</td> <td>5.0</td> <td>2.9</td> </tr> </tbody> </table> <div style="text-align: right; margin-top: 5px;">(in mm)</div> 	Type	a	b	c	GCM03	0.3	0.9	0.3	GCM15	0.4	1.5	0.5	GCM18	1.0	3.0	1.2	GCM21	1.2	4.0	1.65	GCM31	2.2	5.0	2.0	GCM32	2.2	5.0	2.9
		Type	a	b		c																											
		GCM03	0.3	0.9		0.3																											
		GCM15	0.4	1.5		0.5																											
GCM18	1.0	3.0	1.2																														
GCM21	1.2	4.0	1.65																														
GCM31	2.2	5.0	2.0																														
GCM32	2.2	5.0	2.9																														
Capacitance Change	Within the specified tolerance																																
Q/D.F.	30pF min.: Q≥1000 30pF max.: Q≥400+20C C: Nominal Capacitance (pF)	W.V.: 25Vmin.: 0.025 max. W.V.: 16V: 0.035 max. *1																															
I.R.	More than 10,000MΩ or 500Ω · F (Whichever is smaller) *1																																
20	Beam Load Test	The chip endure following force. < Chip L dimension: 2.5mm max. > Chip thickness > 0.5mm rank: 20N Chip thickness ≤ 0.5mm rank: 8N < Chip L dimension: 3.2mm min. > Chip thickness < 1.25mm rank: 15N Chip thickness ≥ 1.25mm rank: 54.5N			Place the capacitor in the beam load fixture as Fig. 4. Apply a force. < Chip Length: 2.5mm max. >  <p style="text-align: center;">Speed supplied the Stress Load: 0.5mm / sec.</p> <p style="text-align: center;">&lt; Chip Length: 3.2mm min. &gt;</p> <p style="text-align: center;">Speed supplied the Stress Load: 2.5mm / sec.</p> <p style="text-align: center;">Fig. 4</p>																												

\*1: The figure indicates typical specification. Please refer to individual specifications.

# Specifications and Test Methods

Continued from the preceding page.

No.	AEC-Q200 Test Item		Specifications		AEC-Q200 Test Method												
			Temperature Compensating Type	High Dielectric Type													
21	Capacitance Temperature Characteristics	Capacitance Change	Within the specified tolerance (Table A)	C7: Within ±22% (-55°C to +125°C) R7: Within ±15% (-55°C to +125°C)	The capacitance change should be measured after 5 min. at each specified temperature stage. (1) Temperature Compensating Type The temperature coefficient is determined using the capacitance measured in step 3 as a reference. When cycling the temperature sequentially from step1 through 5 (ΔC: +25°C to +125°C; other temp. coeffs.: +25°C to +85°C) the capacitance should be within the specified tolerance for the temperature coefficient and capacitance change as shown in Table A. The capacitance drift is calculated by dividing the differences between the maximum and minimum measured values in steps 1, 3 and 5 by the capacitance value in step 3. <table border="1" style="margin: 10px 0;"> <thead> <tr> <th>Step</th> <th>Temperature (°C)</th> </tr> </thead> <tbody> <tr> <td>1</td> <td>25±2</td> </tr> <tr> <td>2</td> <td>-55±3</td> </tr> <tr> <td>3</td> <td>25±2</td> </tr> <tr> <td>4</td> <td>125±3</td> </tr> <tr> <td>5</td> <td>25±2</td> </tr> </tbody> </table> (2) High Dielectric Constant Type The ranges of capacitance change compared with the above 25°C value over the temperature ranges shown in the table should be within the specified ranges. - Initial measurement for high dielectric constant type. - Perform a heat treatment at 150+0/-10°C for one hour and then set for 24±2 hours at room temperature. Perform the initial measurement.	Step	Temperature (°C)	1	25±2	2	-55±3	3	25±2	4	125±3	5	25±2
		Step	Temperature (°C)														
		1	25±2														
2	-55±3																
3	25±2																
4	125±3																
5	25±2																
Temperature Coefficient	Within the specified tolerance (Table A)																
Capacitance Drift	Within ±0.2% or ±0.05 pF (Whichever is larger) * Do not apply to 1X/25V																

\*1: The figure indicates typical specification. Please refer to individual specifications.

Table A

Char.	Nominal Values (ppm/°C) Note1	Capacitance Change from 25°C (%)					
		-55		-30		-10	
		Max.	Min.	Max.	Min.	Max.	Min.
5C	0±30	0.58	-0.24	0.40	-0.17	0.25	-0.11

Note 1: Nominal values denote the temperature coefficient within a range of 25°C to 125°C (for 5C).

■ Minimum Quantity Guide

Part Number	Dimensions (mm)			Quantity (pcs.)					
				ø180mm reel		ø330mm reel		Bulk Case Packaging Code: C	Bulk Bag Packaging Code: B
	L	W	T	Paper Tape Packaging Code: D	Embossed Tape Packaging Code: L	Paper Tape Packaging Code: J	Embossed Tape Packaging Code: K		
<b>GCM03</b>	0.6	0.3	0.3	15,000	-	50,000	-	-	1,000
<b>GCM15</b>	1.0	0.5	0.5	10,000	-	50,000	-	50,000	1,000
<b>GCM18</b>	1.6	0.8	0.8	4,000	-	10,000	-	15,000 <sup>1)</sup>	1,000
<b>GCM21</b>	2.0	1.25	0.6	4,000	-	10,000	-	10,000	1,000
			0.85	4,000	-	10,000	-	-	1,000
			1.25	-	3,000	-	10,000	5,000 <sup>1)</sup>	1,000
<b>GCM31</b>	3.2	1.6	0.85	4,000	-	10,000	-	-	1,000
			1.15	-	3,000	-	10,000	-	1,000
			1.6	-	2,000	-	6,000	-	1,000
<b>GCM32</b>	3.2	2.5	1.15	-	3,000	-	10,000	-	1,000
			1.35	-	2,000	-	8,000	-	1,000
			1.6	-	2,000	-	6,000	-	1,000
			1.8/2.0/2.5	-	1,000	-	4,000	-	1,000

1) There are parts number without bulk case.

■ Tape Carrier Packaging

1. Dimensions of Reel

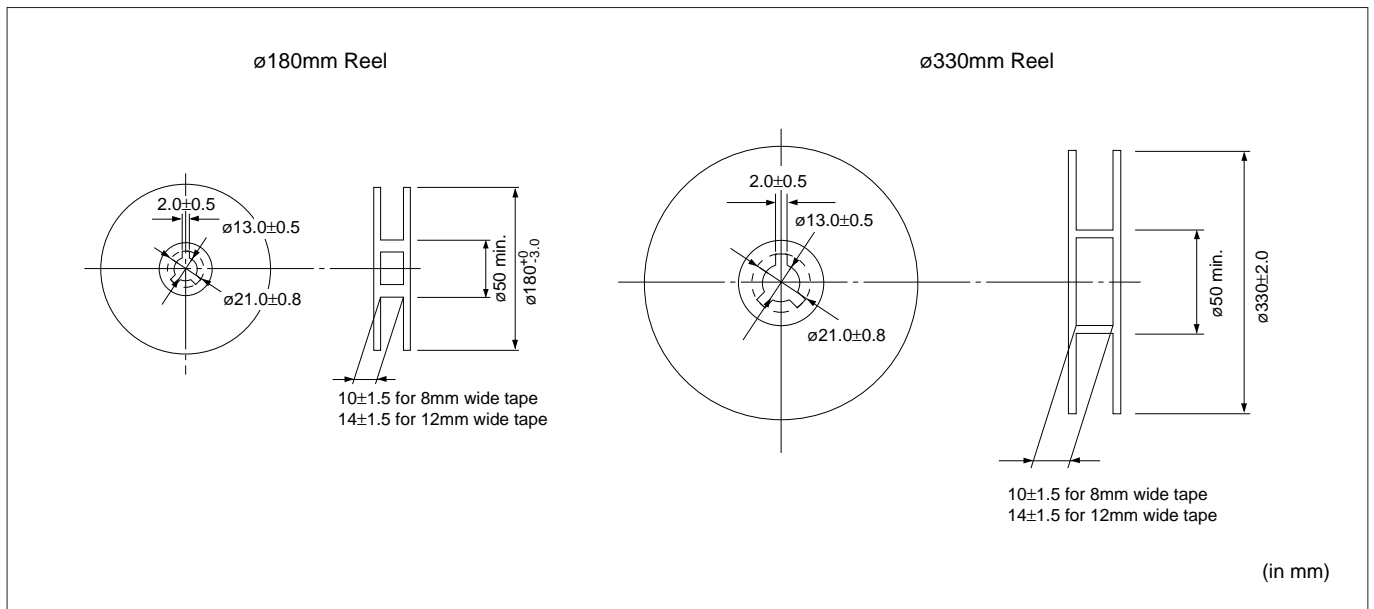

Continued on the following page.

# Package

Continued from the preceding page.

## 2. Dimensions of Paper Tape

8mm width 4mm pitch Tape

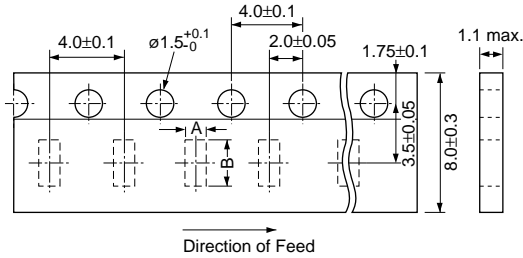

Part Number	A	B
<b>GCM18</b>	1.05±0.1	1.85±0.1
<b>GCM21</b> (T≤0.85mm)	1.55±0.15	2.3±0.15
<b>GCM31</b> (T≤0.85mm)	2.0±0.2	3.6±0.2
<b>GCM32</b> (T=0.85mm)	2.8±0.2	3.6±0.2

8mm width 2mm pitch Tape

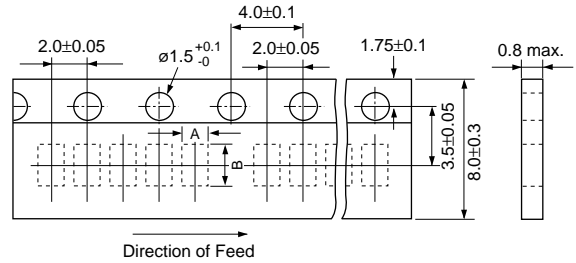

Part Number	A*	B*
<b>GCM03</b>	0.37	0.67
<b>GCM15</b>	0.65	1.15

\*Nominal Value

(in mm)

## 3. Dimensions of Embossed Tape

8mm width 4mm pitch Tape

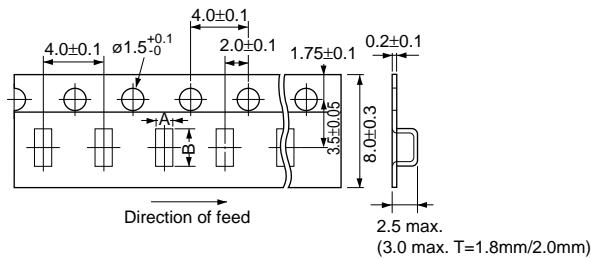

Part Number	A	B
<b>GCM21</b> (T=1.25mm)	1.45±0.2	2.25±0.2
<b>GCM31</b> (T≥1.15mm)	1.9±0.2	3.5±0.2
<b>GCM32</b> (T≥1.15mm)	2.8±0.2	3.5±0.2

\*Nominal Value

(in mm)

Continued on the following page. ↗

Continued from the preceding page.

#### 4. Taping Method

- (1) Tapes for capacitors are wound clockwise. The sprocket holes are to the right as the tape is pulled toward the user.
- (2) Part of the leader and part of the empty tape should be attached to the end of the tape as follows.
- (3) The top tape and base tape are not attached at the end of the tape for a minimum of 5 pitches.
- (4) Missing capacitors number within 0.1% of the number per reel or 1 pc, whichever is greater, and are not continuous.
- (5) The top tape and bottom tape should not protrude beyond the edges of the tape and should not cover sprocket holes.
- (6) Cumulative tolerance of sprocket holes, 10 pitches:  $\pm 0.3\text{mm}$ .
- (7) Peeling off force: 0.1 to 0.6N\* in the direction shown below.

\*GCM03: 0.05 to 0.5N

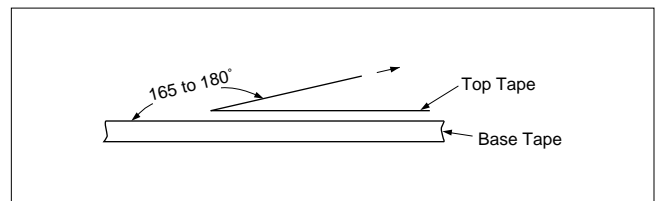
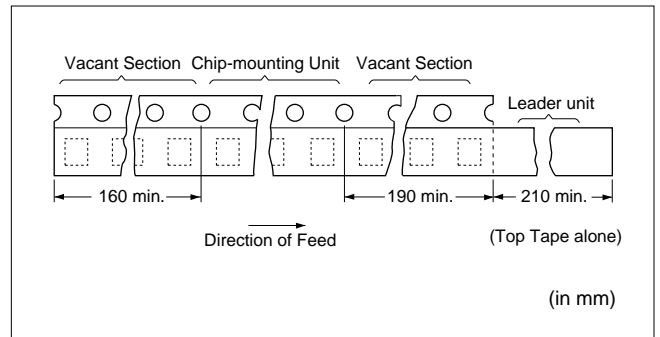

#### ■ Dimensions of Bulk Case Packaging

The bulk case uses antistatic materials. Please contact Murata for details.

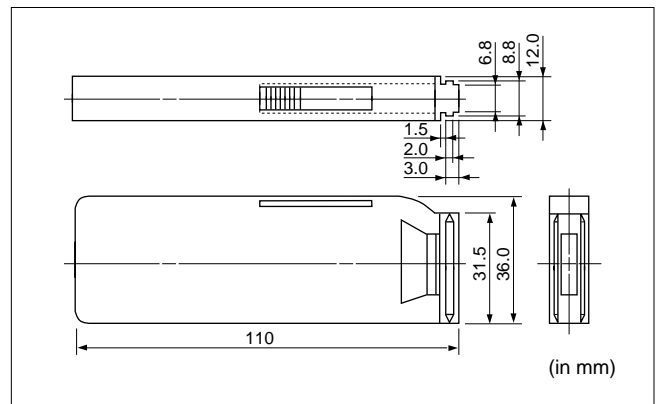

## ⚠ Caution (Storage and Operation Condition)

### ■ Storage and Operation condition

1. The performance of chip monolithic ceramic capacitors may be affected by the storage conditions.

1-1. Store capacitors in the following conditions:

Temperature of +5°C to +40°C and a Relative Humidity of 20% to 70%.

(1) Sunlight, dust, rapid temperature changes, corrosive gas atmosphere or high temperature and humidity conditions during storage may affect the solderability and the packaging performance. Please use product within six months of receipt.

(2) Please confirm solderability before using after six months. Store the capacitors without opening the original bag. Even if the storage period is short, do not exceed the specified atmospheric conditions.

1-2. Corrosive gas can react with the termination (external) electrodes or lead wires of capacitors, and result in poor solderability. Do not store the capacitors in an atmosphere consisting of corrosive gas (e.g., hydrogen sulfide, sulfur dioxide, chlorine, ammonia gas, etc.).

1-3. Due to moisture condensation caused by rapid humidity changes, or the photochemical change caused by direct sunlight on the terminal electrodes and/or the resin/epoxy coatings, the solderability and electrical performance may deteriorate. Do not store capacitors under direct sunlight or in high humidity conditions.



**Rating**

**1. Temperature Dependent Characteristics**

1. The electrical characteristics of the capacitor can change with temperature.

1-1. For capacitors having larger temperature dependency, the capacitance may change with temperature changes.

The following actions are recommended in order to insure suitable capacitance values.

(1) Select a suitable capacitance for the operating temperature range.

(2) The capacitance may change within the rated temperature.

When you use a high dielectric constant type capacitors in a circuit that needs a tight (narrow) capacitance tolerance. Example: a time constant circuit., please carefully consider the characteristics of these capacitors, such as their aging, voltage, and temperature characteristics. And check capacitors using your actual appliances at the intended environment and operating conditions.

Typical Temperature Characteristics Char. R6(X5R)

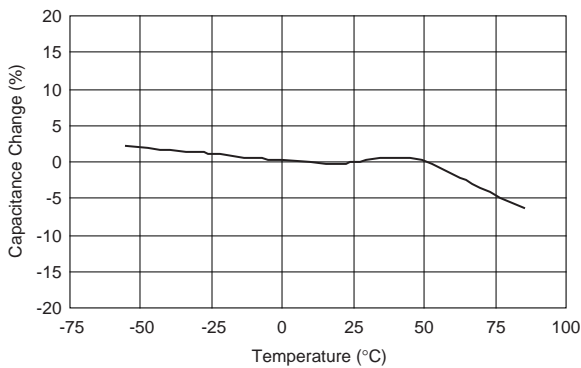

Typical Temperature Characteristics Char. R7(X7R)

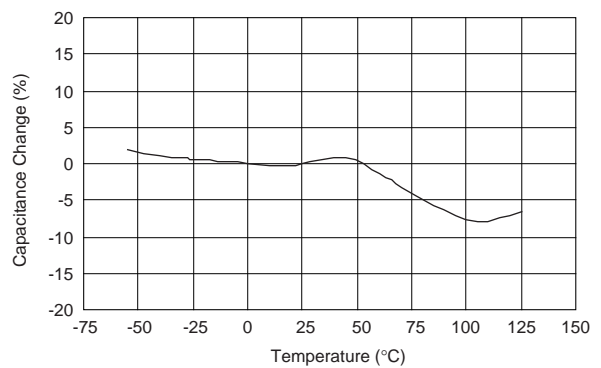

Typical Temperature Characteristics Char. F5(Y5V)

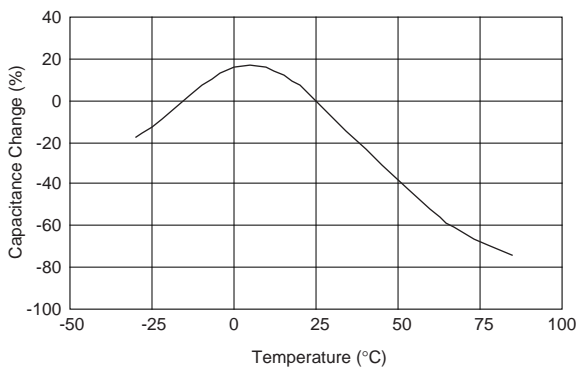

**2. Measurement of Capacitance**

1. Measure capacitance with the voltage and the frequency specified in the product specifications.

1-1. The output voltage of the measuring equipment may decrease when capacitance is high occasionally. Please confirm whether a prescribed measured voltage is impressed to the capacitor.

1-2. The capacitance values of high dielectric constant type capacitors change depending on the AC voltage applied. Please consider the AC voltage characteristics when selecting a capacitor to be used in a AC circuit.

Continued on the following page.

## ⚠ Caution (Rating)

☐ Continued from the preceding page.

### 3. Applied Voltage

1. Do not apply a voltage to the capacitor that exceeds the rated voltage as called-out in the specifications.

1-1. Applied voltage between the terminals of a capacitor shall be less than or equal to the rated voltage.

(1) When AC voltage is superimposed on DC voltage, the zero-to-peak voltage shall not exceed the rated DC voltage.

When AC voltage or pulse voltage is applied, the peak-to-peak voltage shall not exceed the rated DC voltage.

(2) Abnormal voltages (surge voltage, static electricity, pulse voltage, etc.) shall not exceed the rated DC voltage.

#### Typical Voltage Applied to the DC Capacitor

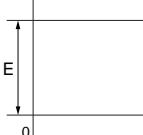
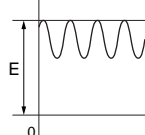
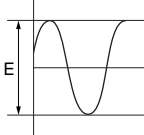
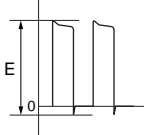
DC Voltage	DC Voltage+AC	AC Voltage	Pulse Voltage
			

(E: Maximum possible applied voltage.)

1-2. Influence of overvoltage

Overvoltage that is applied to the capacitor may result in an electrical short circuit caused by the breakdown of the internal dielectric layers .

The time duration until breakdown depends on the applied voltage and the ambient temperature.

### 4. Applied Voltage and Self-heating Temperature

1. When the capacitor is used in a high-frequency voltage, pulse voltage, application, be sure to take into account self-heating may be caused by resistant factors of the capacitor.

1-1. The load should be contained to the level such that when measuring at atmospheric temperature of 25°C, the product's self-heating remains below 20°C and surface temperature of the capacitor in the actual circuit remains within the maximum operating temperature.

Continued on the following page. ☐

**Caution (Rating)**

Continued from the preceding page.

**5. DC Voltage and AC Voltage Characteristic**

1. The capacitance value of a high dielectric constant type capacitor changes depending on the DC voltage applied. Please consider the DC voltage characteristics when a capacitor is selected for use in a DC circuit.

1-1. The capacitance of ceramic capacitors may change sharply depending on the applied voltage. (See figure)

Please confirm the following in order to secure the capacitance.

- (1) Whether the capacitance change caused by the applied voltage is within the range allowed or not.
- (2) In the DC voltage characteristics, the rate of capacitance change becomes larger as voltage increases. Even if the applied voltage is below the rated voltage. When a high dielectric constant type capacitor is in a circuit that needs a tight (narrow) capacitance tolerance. Example: a time constant circuit., please carefully consider the characteristics of these capacitors, such as their aging, voltage, and temperature characteristics. And check capacitors using your actual appliances at the intended environment and operating conditions.

2. The capacitance values of high dielectric constant type capacitors change depending on the AC voltage applied. Please consider the AC voltage characteristics when selecting a capacitor to be used in a AC circuit.

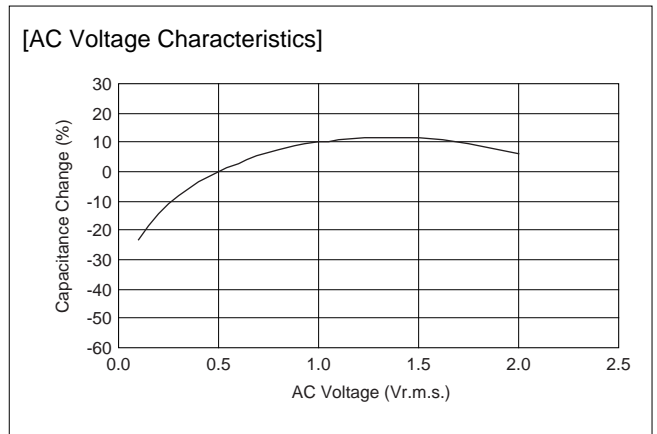
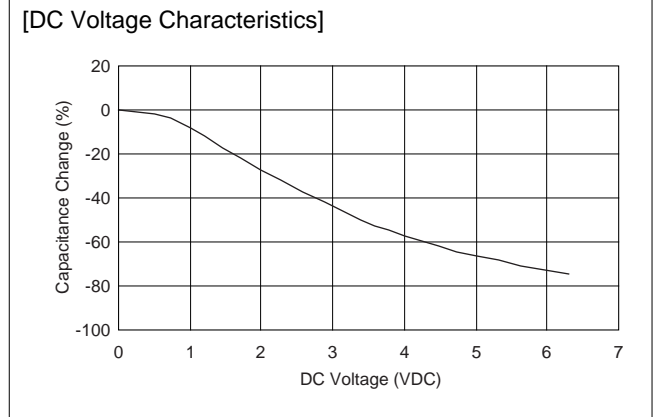

**6. Capacitance Aging**

1. The high dielectric constant type capacitors have the characteristic in which the capacitance value decreases with passage of time.

When you use a high dielectric constant type capacitors in a circuit that needs a tight (narrow) capacitance tolerance. Example: a time constant circuit., please carefully consider the characteristics of these capacitors, such as their aging, voltage, and temperature characteristics. And check capacitors using your actual appliances at the intended environment and operating conditions.

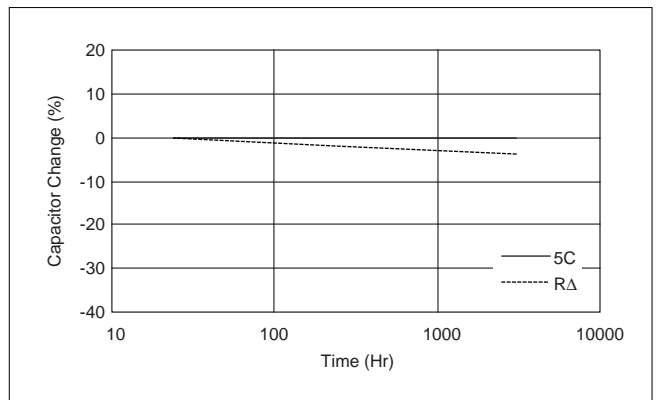

Continued on the following page. ↗

## ⚠ Caution (Rating)

☒ Continued from the preceding page.

### 7. Vibration and Shock

1. The capacitors mechanical stress (vibration and shock) shall be specified for the use environment.  
Please confirm the kind of vibration and/or shock, its condition, and any generation of resonance.  
Please mount the capacitor so as not to generate resonance, and do not allow any impact on the terminals.
2. Mechanical shock due to falling may cause damage or a crack in the dielectric material of the capacitor.  
Do not use a fallen capacitor because the quality and reliability may be deteriorated.
3. When printed circuit boards are piled up or handled, the corners of another printed circuit board should not be allowed to hit the capacitor in order to avoid a crack or other damage to the capacitor.

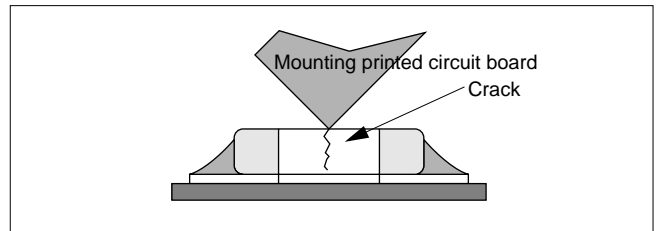
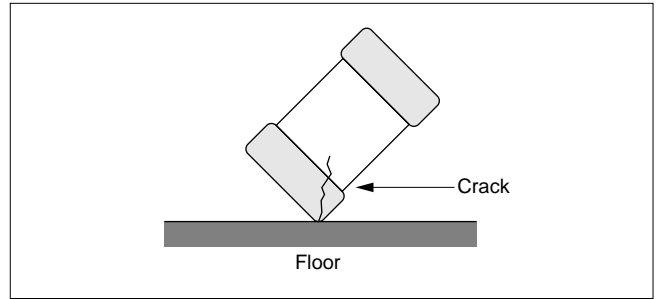

## ⚠ Caution (Soldering and Mounting)

### ■ Soldering and Mounting

#### 1. Mounting Position

1. Confirm the best mounting position and direction that minimizes the stress imposed on the capacitor during flexing or bending the printed circuit board.
- 1-1. Choose a mounting position that minimizes the stress imposed on the chip during flexing or bending of the board.

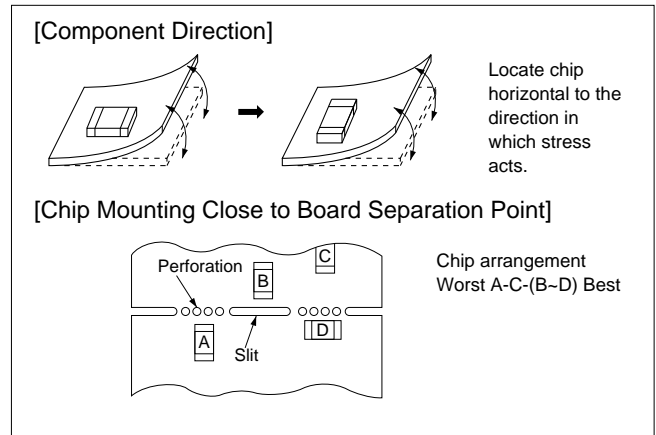

#### 2. Information before Mounting

1. Do not re-use capacitors that were removed from the equipment.
2. Confirm capacitance characteristics under actual applied voltage.
3. Confirm the mechanical stress under actual process and equipment use.
4. Confirm the rated capacitance, rated voltage and other electrical characteristics before assembly.

5. Prior to use, confirm the Solderability for the capacitors that were in long-term storage.
6. Prior to measuring capacitance, carry out a heat treatment for capacitors that were in long-term storage.
7. The use of Sn-Zn based solder will deteriorate the reliability of the MLCC.  
Please contact our sales representative or product engineers on the use of Sn-Zn based solder in advance.

#### 3. Maintenance of the Mounting (pick and place) Machine

1. Make sure that the following excessive forces are not applied to the capacitors.
  - 1-1. In mounting the capacitors on the printed circuit board, any bending force against them shall be kept to a minimum to prevent them from any bending damage or cracking. Please take into account the following precautions and recommendations for use in your process.
    - (1) Adjust the lowest position of the pickup nozzle so as not to bend the printed circuit board.
    - (2) Adjust the nozzle pressure within a static load of 1N to 3N during mounting.
2. Dirt particles and dust accumulated between the suction nozzle and the cylinder inner wall prevent the nozzle from moving smoothly. This imposes greater force upon the chip during mounting, causing cracked chips. Also the locating claw, when worn out, imposes uneven forces on the chip when positioning, causing cracked chips. The suction nozzle and the locating claw must be maintained, checked and replaced periodically.

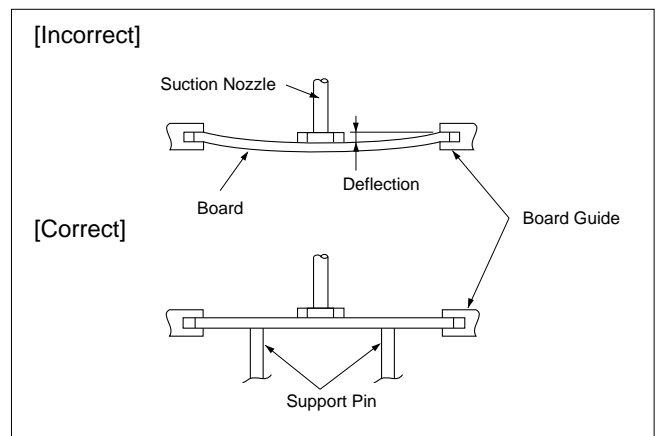

Continued on the following page.

## ⚠ Caution (Soldering and Mounting)

☐ Continued from the preceding page.

### 4-1. Reflow Soldering

- When sudden heat is applied to the components, the mechanical strength of the components will decrease because a sudden temperature change causes deformation inside the components. In order to prevent mechanical damage to the components, preheating is required for both the components and the PCB board. Preheating conditions are shown in table 1. It is required to keep the temperature differential between the solder and the components surface ( $\Delta T$ ) as small as possible.
- Solderability of Tin plating termination chips might be deteriorated when a low temperature soldering profile where the peak solder temperature is below the melting point of Tin is used. Please confirm the Solderability of Tin plated termination chips before use.
- When components are immersed in solvent after mounting, be sure to maintain the temperature difference ( $\Delta T$ ) between the component and the solvent within the range shown in the table 1.

Table 1

Part Number	Temperature Differential
GRM03/15/18/21/31	$\Delta T \leq 190^\circ\text{C}$
GCM32	$\Delta T \leq 130^\circ\text{C}$

#### Recommended Conditions

	Pb-Sn Solder		Lead Free Solder
	Infrared Reflow	Vapor Reflow	
Peak Temperature	230 to 250°C	230 to 240°C	240 to 260°C
Atmosphere	Air	Air	Air or N <sub>2</sub>

Pb-Sn Solder: Sn-37Pb

Lead Free Solder: Sn-3.0Ag-0.5Cu

### 4. Optimum Solder Amount for Reflow Soldering

- Overly thick application of solder paste results in a excessive solder fillet height. This makes the chip more susceptible to mechanical and thermal stress on the board and may cause the chips to crack.
- Too little solder paste results in a lack of adhesive strength on the outer electrode, which may result in chips breaking loose from the PCB.
- Make sure the solder has been applied smoothly to the end surface to a height of 0.2mm\* min.

#### Inverting the PCB

Make sure not to impose any abnormal mechanical shocks to the PCB.

#### [Standard Conditions for Reflow Soldering]

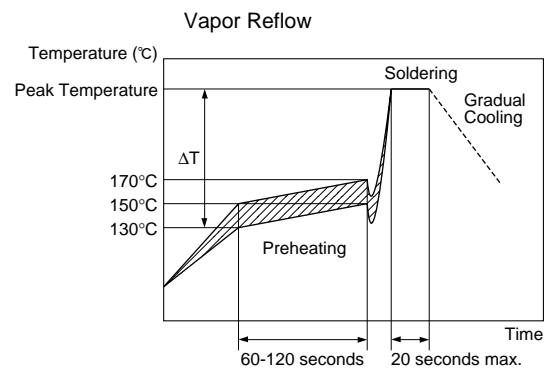
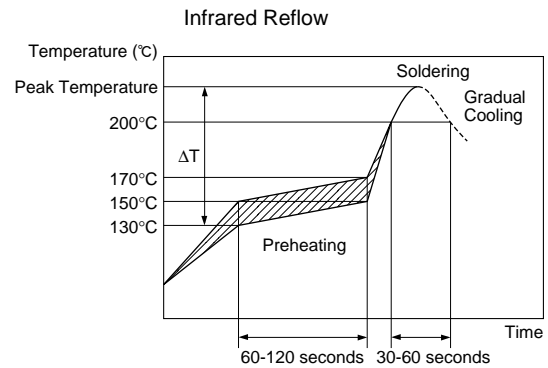

#### [Allowable Reflow Soldering Temperature and Time]

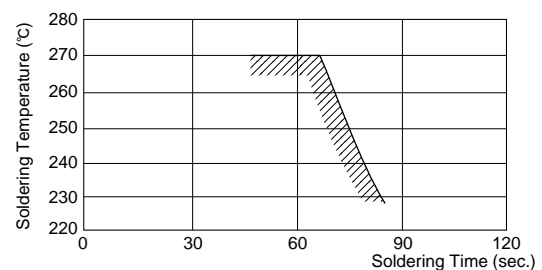

In case of repeated soldering, the accumulated soldering time must be within the range shown above.

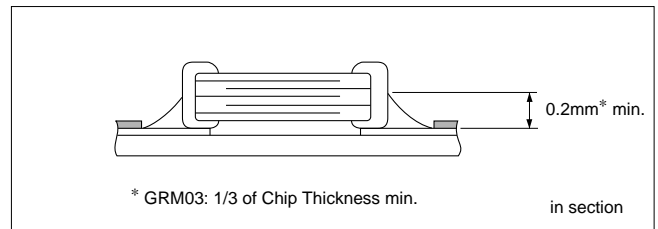

Continued on the following page. ☐

**Caution (Soldering and Mounting)**

Continued from the preceding page.

**4-2. Flow Soldering**

1. When sudden heat is applied to the components, the mechanical strength of the components will decrease because a sudden temperature change causes deformation inside the components. In order to prevent mechanical damage in the components, preheating should be required for both of the components and the PCB board.  
 Preheating conditions are shown in table 2. It is required to keep temperature differential between the solder and the components surface ( $\Delta T$ ) as small as possible.
2. Excessively long soldering time or high soldering temperature can result in leaching of the outer electrodes, causing poor adhesion or a reduction in capacitance value due to loss of contact between electrodes and end termination.
3. When components are immersed in solvent after mounting, be sure to maintain the temperature difference ( $\Delta T$ ) between the component and solvent within the range shown in the table 2.
4. Do not apply flow soldering to chips not listed in table 2.

Table 2

Part Number	Temperature Differential
<b>GCM18/21/31</b>	$\Delta T \leq 150^{\circ}\text{C}$

**Recommended Conditions**

	Pb-Sn Solder	Lead Free Solder
Preheating Peak Temperature	90 to 110°C	100 to 120°C
Soldering Peak Temperature	240 to 250°C	250 to 260°C
Atmosphere	Air	N <sub>2</sub>

Pb-Sn Solder: Sn-37Pb

Lead Free Solder: Sn-3.0Ag-0.5Cu

**5. Optimum Solder Amount for Flow Soldering**

- 5-1. The top of the solder fillet should be lower than the thickness of components. If the solder amount is excessive, the risk of cracking is higher during board bending or any other stressful condition.

**[Standard Conditions for Flow Soldering]**

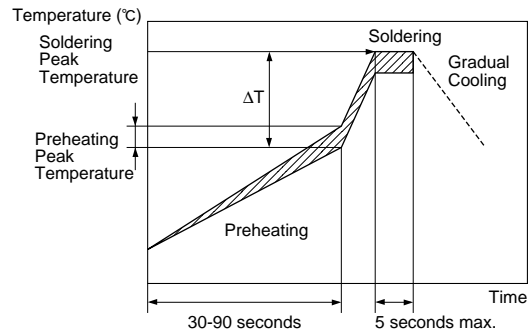

**[Allowable Flow Soldering Temperature and Time]**

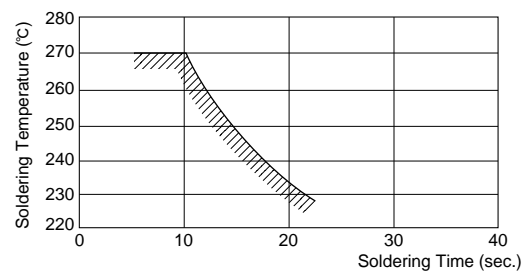

In case of repeated soldering, the accumulated soldering time must be within the range shown above.

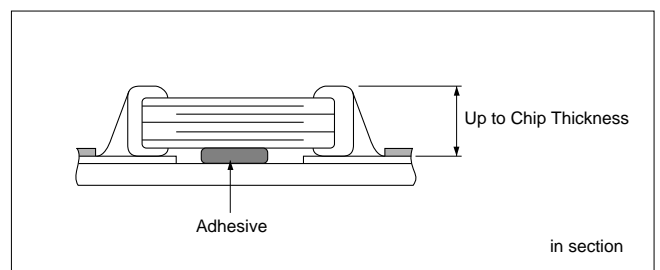

Continued on the following page. ↗

## ⚠ Caution (Soldering and Mounting)

☞ Continued from the preceding page.

### 4-3. Correction with a Soldering Iron

1. When sudden heat is applied to the components when using a soldering iron, the mechanical strength of the components will decrease because the extreme temperature change can cause deformations inside the components. In order to prevent mechanical damage to the components, preheating is required for both the components and the PCB board. Preheating conditions, (The "Temperature of the Soldering Iron Tip", "Preheating Temperature", "Temperature Differential" between the iron tip and the components and the PCB), should be within the conditions of table 3. It is required to keep the temperature differential between the soldering iron and the component surfaces ( $\Delta T$ ) as small as possible.
2. After soldering, do not allow the component/PCB to rapidly cool down.
3. The operating time for the re-working should be as short as possible. When re-working time is too long, it may cause solder leaching, and that will cause a reduction in the adhesive strength of the terminations.
4. Optimum Solder amount when re-working with a Soldering Iron
  - 4-1. In case of sizes smaller than 0603, (GCM03/15/18), the top of the solder fillet should be lower than 2/3's of the thickness of the component or 0.5mm whichever is smaller. In case of 0805 and larger sizes, (GCM21/31/32), the top of the solder fillet should be lower than 2/3's of the thickness of the component. If the solder amount is excessive, the risk of cracking is higher during board bending or under any other stressful condition.
  - 4-2. A soldering iron with a tip of  $\phi 3\text{mm}$  or smaller should be used. It is also necessary to keep the soldering iron from touching the components during the re-work.
  - 4-3. Solder wire with  $\phi 0.5\text{mm}$  or smaller is required for soldering.

### 4-4. Leaded Component Insertion

1. If the PCB is flexed when leaded components (such as transformers and ICs) are being mounted, chips may crack and solder joints may break.  
 Before mounting leaded components, support the PCB using backup pins or special jigs to prevent warping.

### 5. Washing

Excessive ultrasonic oscillation during cleaning can cause the PCBs to resonate, resulting in cracked chips or broken solder joints. Take note not to vibrate PCBs.

Table 3

Part Number	Temperature of Soldering Iron Tip	Preheating Temperature	Temperature Differential ( $\Delta T$ )	Atmosphere
<b>GCM03/15/18/21/31</b>	350°C max.	150°C min.	$\Delta T \leq 190^\circ\text{C}$	Air
<b>GCM32</b>	280°C max.	150°C min.	$\Delta T \leq 130^\circ\text{C}$	Air

\*Applicable for both Pb-Sn and Lead Free Solder.  
 Pb-Sn Solder: Sn-37Pb  
 Lead Free Solder: Sn-3.0Ag-0.5Cu

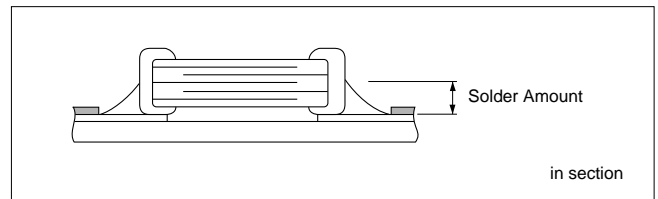

Continued on the following page. ☞



## ⚠ Caution (Soldering and Mounting)

☐ Continued from the preceding page.

### 6. Electrical Test on Printed Circuit Board

1. Confirm position of the support pin or specific jig, when inspecting the electrical performance of a capacitor after mounting on the printed circuit board.

1-1. Avoid bending printed circuit board by the pressure of a test pin, etc.

The thrusting force of the test probe can flex the PCB, resulting in cracked chips or open solder joints. Provide support pins on the back side of the PCB to prevent warping or flexing.

1-2. Avoid vibration of the board by shock when a test pin contacts a printed circuit board.

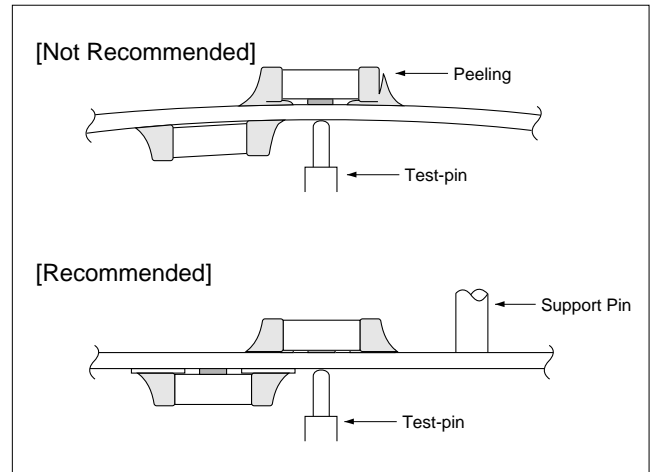

### 7. Printed Circuit Board Cropping

1. After mounting a capacitor on a printed circuit board, do not apply any stress to the capacitor that is caused by bending or twisting the board.

1-1. In cropping the board, the stress as shown right may cause the capacitor to crack.

Try not to apply this type of stress to a capacitor.

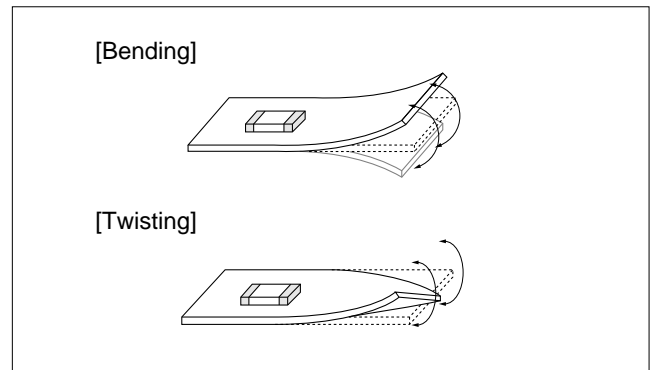

2. Check of the cropping method for the printed circuit board in advance.

2-1. Printed circuit board cropping shall be carried out by using a jig or an apparatus to prevent the mechanical stress which can occur to the board.

(1) Example of a suitable jig

Recommended example: the board should be pushed as close to the near the cropping jig as possible and from the back side of board in order to minimize the compressive stress applied to capacitor.

Not recommended example\* when the board is pushed at a point far from the cropping jig and from the front side of board as below, the capacitor may form a crack caused by the tensile stress applied to capacitor.

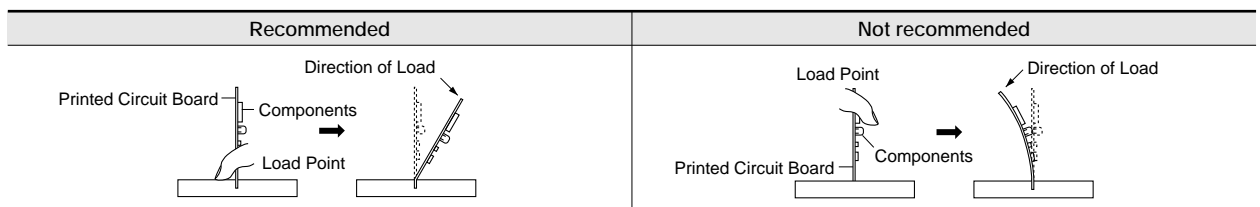
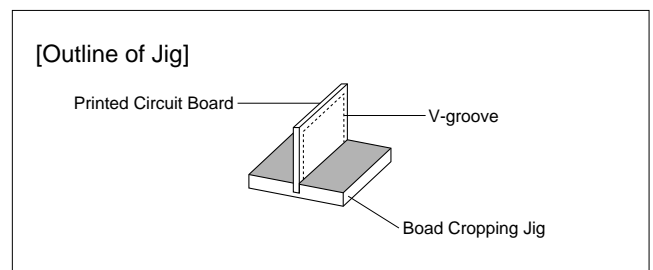

Continued on the following page. ☐

## ⚠ Caution (Soldering and Mounting)

☐ Continued from the preceding page.

### (2) Example of a suitable machine

An outline of a printed circuit board cropping machine is shown as follows. Along the lines with the V-grooves on printed circuit board, the top and bottom blades are aligned to one another when cropping the board.

The misalignment of the position between top and bottom blades may cause the capacitor to crack.

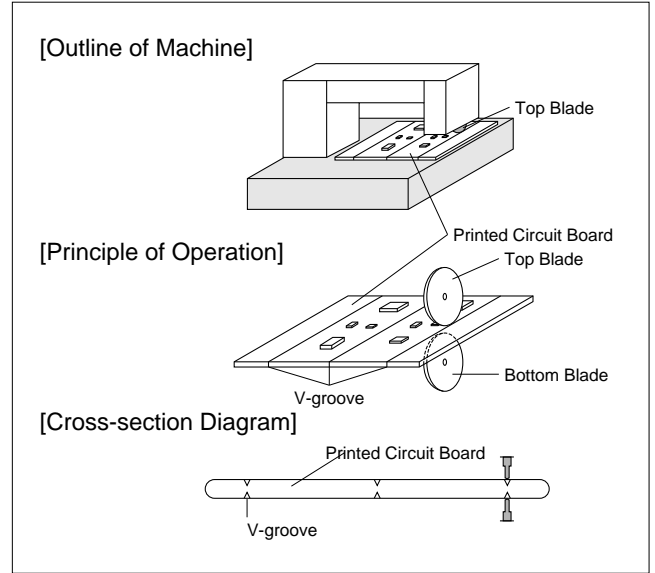

Recommended	Not Recommended		
	Top-bottom Misalignment	Left-right Misalignment	Front-rear Misalignment
<p>Top Blade</p> <p>Bottom Blade</p>	<p>Top Blade</p> <p>Bottom Blade</p>	<p>Top Blade</p> <p>Bottom Blade</p>	<p>Top Blade</p> <p>Bottom Blade</p>

## ■ Others

### 1. Under Operation of Equipment

- 1-1. Do not touch a capacitor directly with bare hands during operation in order to avoid the danger of a electric shock.
- 1-2. Do not allow the terminals of a capacitor to come in contact with any conductive objects (short-circuit). Do not expose a capacitor to a conductive liquid, inducing any acid or alkali solutions.
- 1-3. Confirm the environment in which the equipment will operation is under the specified conditions. Do not use the equipment under the following environment.
  - (1) Being spattered with water or oil.
  - (2) Being exposed to direct sunlight.
  - (3) Being exposed to Ozone, ultraviolet rays or radiation.
  - (4) Being exposed to toxic gas (e.g., hydrogen sulfide, sulfur dioxide, chlorine, ammonia gas, etc.)
  - (5) Any vibrations or mechanical shocks exceeding the specified limits.
  - (6) Moisture condensing environments.
- 1-4. Use damp proof countermeasures if using under any conditions that can cause condensation.

### 2. Others

- 2-1. In an Emergency
  - (1) If the equipment should generate smoke, fire or smell, immediately turn off or unplug the equipment.

If the equipment is not turned off or unplugged, the hazards may be worsened by supplying continuous power.

- (2) In this type of situation, do not allow face and hands to come in contact with the capacitor or burns may be caused by the capacitors high temperature.

### 2-2. Disposal of Waste

When capacitors are disposed, they must be burned or buried by the industrial waste vender with the appropriate licenses.

### 2-3. Circuit Design

GRM, GCM, GMA/D, LLL/A/M, ERB, GQM, GJM, GNM Series capacitors in this catalog are not safety certified products.

### 2-4. Remarks

Failure to follow the cautions may result, worst case, in a short circuit and smoking when the product is used.

The above notices are for standard applications and conditions. Contact us when the products are used in special mounting conditions.

Select optimum conditions for operation as they determine the reliability of the product after assembly. The data herein are given in typical values, not guaranteed ratings.

## Notice (Rating)

### ■ Rating

#### 1. Operating Temperature

1. The operating temperature limit depends on the capacitor.

- 1-1. Do not apply temperatures exceeding the upper operating temperature.

It is necessary to select a capacitor with a suitable rated temperature which will cover the operating temperature range.

Also it is necessary to consider the temperature distribution in equipment and the seasonal temperature variable factor.

- 1-2. Consider the self-heating of the capacitor

The surface temperature of the capacitor shall be the upper operating temperature or less when including the self-heating factors.

#### 2. Atmosphere Surroundings (gaseous and liquid)

1. Restriction on the operating environment of capacitors.

- 1-1. The capacitor, when used in the above, unsuitable, operating environments may deteriorate due to the corrosion of the terminations and the penetration of moisture into the capacitor.

- 1-2. The same phenomenon as the above may occur when the electrodes or terminals of the capacitor are subject to moisture condensation.

- 1-3. The deterioration of characteristics and insulation resistance due to the oxidization or corrosion of terminal electrodes may result in breakdown when the capacitor is exposed to corrosive or volatile gases or solvents for long periods of time.

#### 3. Piezo-electric Phenomenon

1. When using high dielectric constant type capacitors in AC or pulse circuits, the capacitor itself vibrates at specific frequencies and noise may be generated. Moreover, when the mechanical vibration or shock is added to capacitor, noise may occur.

# Notice (Soldering and Mounting)

## ■ Soldering and Mounting

### 1. PCB Design

#### 1. Notice for Pattern Forms

- 1-1. Unlike leaded components, chip components are susceptible to flexing stresses since they are mounted directly on the substrate. They are also more sensitive to mechanical and thermal stresses than leaded components. Excess solder fillet height can multiply these stresses and cause chip cracking. When designing substrates, take land patterns and dimensions into consideration to eliminate the possibility of excess solder fillet height.
- 1-2. It is possible for the chip to crack by the expansion and shrinkage of a metal board. Please contact us if you want to use our ceramic capacitors on a metal board such as Aluminum.

### Pattern Forms

	Prohibited	Correct
Placing Close to Chassis		
Placing of Chip Components and Leaded Components		
Placing of Leaded Components after Chip Component		
Lateral Mounting		

Continued on the following page.

## Notice (Soldering and Mounting)

Continued from the preceding page.

### 2. Land Dimensions

- 2-1. Chip capacitor can be cracked due to the stress of PCB bending / etc if the land area is larger than needed and has an excess amount of solder. Please refer to the land dimensions in table 1 for flow soldering, table 2 for reflow soldering. Please confirm the suitable land dimension by evaluating of the actual SET / PCB.

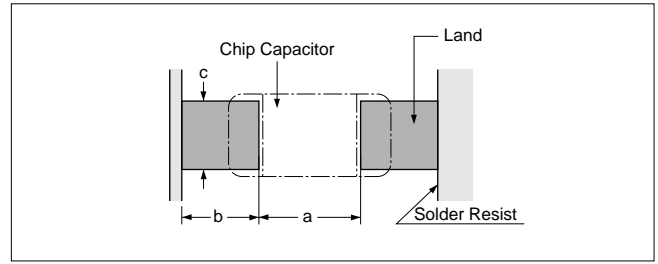

Table 1 Flow Soldering Method

Part Number	Dimensions Chip (L×W)	a	b	c
GCM18	1.6×0.8	0.6 to 1.0	0.8 to 0.9	0.6 to 0.8
GCM21	2.0×1.25	1.0 to 1.2	0.9 to 1.0	0.8 to 1.1
GCM31	3.2×1.6	2.2 to 2.6	1.0 to 1.1	1.0 to 1.4

(in mm)

Table 2 Reflow Soldering Method

Part Number	Dimensions Chip (L×W)	a	b	c
GCM03	0.6×0.3	0.2 to 0.3	0.2 to 0.35	0.2 to 0.4
GCM15	1.0×0.5	0.3 to 0.5	0.35 to 0.45	0.4 to 0.6
GCM18	1.6×0.8	0.6 to 0.8	0.6 to 0.7	0.6 to 0.8
GCM21	2.0×1.25	1.0 to 1.2	0.6 to 0.7	0.8 to 1.1
GCM31	3.2×1.6	2.2 to 2.4	0.8 to 0.9	1.0 to 1.4
GCM32	3.2×2.5	2.0 to 2.4	1.0 to 1.2	1.8 to 2.3

(in mm)

### 2. Adhesive Application

- Thin or insufficient adhesive can cause the chips to loosen or become disconnected during flow soldering. The amount of adhesive must be more than dimension c, shown in the drawing at right, to obtain the correct bonding strength. The chip's electrode thickness and land thickness must also be taken into consideration.
- Low viscosity adhesive can cause chips to slip after mounting. The adhesive must have a viscosity of 5000Pa · s (500ps) min. (at 25°C).

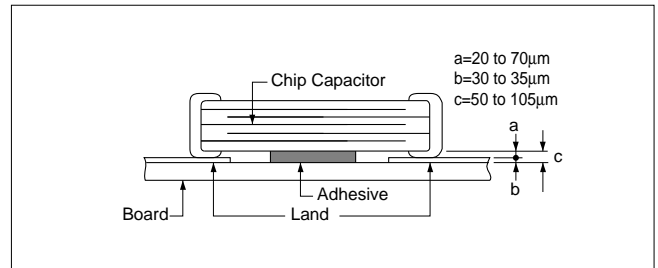

### 3. Adhesive Coverage

Part Number	Adhesive Coverage*
GCM18	0.05mg min.
GCM21	0.1mg min.
GCM31	0.15mg min.

\*Nominal Value

### 3. Adhesive Curing

- Insufficient curing of the adhesive can cause chips to disconnect during flow soldering and causes deterioration in the insulation resistance between the outer electrodes due to moisture absorption. Control curing temperature and time in order to prevent insufficient hardening.

Continued on the following page. ↗

## Notice (Soldering and Mounting)

1

☐ Continued from the preceding page.

### 4. Flux Application

1. An excessive amount of flux generates a large quantity of flux gas, which can cause a deterioration of Solderability. So apply flux thinly and evenly throughout. (A foaming system is generally used for flow soldering).
2. Flux containing too a high percentage of halide may cause corrosion of the outer electrodes unless there is sufficient cleaning. Use flux with a halide content of 0.1% max.

### 5. Flow Soldering

- Set temperature and time to ensure that leaching of the outer electrode does not exceed 25% of the chip end area as a single chip (full length of the edge A-B-C-D shown right) and 25% of the length A-B shown below as mounted on substrate.

3. Do not use strong acidic flux.
4. Do not use water-soluble flux.  
(\*Water-soluble flux can be defined as non rosin type flux including wash-type flux and non-wash-type flux.)

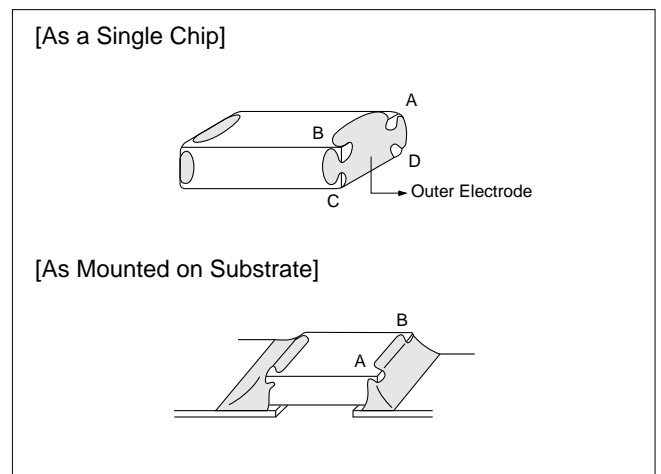

### 6. Washing

1. Please evaluate a capacitor by actual cleaning equipment and condition surely for confirming the quality and select the applicable solvent.
2. Unsuitable cleaning solvent may leave residual flux, other foreign substances, causing deterioration of electrical characteristics and the reliability of the capacitors.

3. Select the proper cleaning conditions.  
3-1. Improper cleaning conditions (excessive or insufficient) may result in the deterioration of the performance of the capacitors.

### 7. Coating

1. A crack may be caused in the capacitor due to the stress of the thermal contraction of the resin during curing process.  
The stress is affected by the amount of resin and curing contraction.  
Select a resin with small curing contraction.  
The difference in the thermal expansion coefficient between a coating resin or a molding resin and capacitor may cause the destruction and deterioration of the capacitor such as a crack or peeling, and lead to the deterioration of insulation resistance or dielectric breakdown.

- Select a resin for which the thermal expansion coefficient is as close to that of capacitor as possible.  
A silicone resin can be used as an under-coating to buffer against the stress.
2. Select a resin that is less hygroscopic.  
Using hygroscopic resins under high humidity conditions may cause the deterioration of the insulation resistance of a capacitor.  
An epoxy resin can be used as a less hygroscopic resin.

## Notice (Others)

### ■ Others

#### 1. Transportation

1. The performance of a capacitor may be affected by the conditions during transportation.

1-1. The capacitors shall be protected against excessive temperature, humidity and mechanical force during transportation.

##### (1) Climatic condition

- low air temperature: -40°C
- change of temperature air/air: -25°C/+25°C
- low air pressure: 30 kPa
- change of air pressure: 6 kPa/min.

##### (2) Mechanical condition

Transportation shall be done in such a way that the boxes are not deformed and forces are not directly passed on to the inner packaging.

1-2. Do not apply excessive vibration, shock, and pressure to the capacitor.

- (1) When excessive mechanical shock or pressure is applied to a capacitor, chipping or cracking may occur in the ceramic body of the capacitor.
- (2) When a sharp edge of an air driver, a soldering iron, tweezers, a chassis, etc. impacts strongly on the surface of capacitor, the capacitor may crack and short-circuit.

1-3. Do not use a capacitor to which excessive shock was applied by dropping, etc.

The capacitor dropped accidentally during processing may be damaged.



# Chip Monolithic Ceramic Capacitors for Automotive



## Medium Voltage for Automotive GCM Series Low Dissipation Factor

### ■ Features

1. The GCM series meet AEC-Q200 requirements.
2. Low-loss and suitable for high frequency circuits
3. Murata's original internal electrode structure realizes high flash-over voltage.
4. A new monolithic structure for small, surface-mountable devices capable of operating at high voltage levels.
5. Sn-plated external electrodes realize good solderability.
6. Use the GCM21/31 type with flow or reflow soldering, and other types with reflow soldering only.

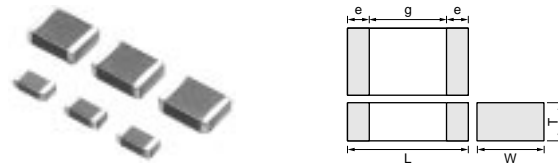

Part Number	Dimensions (mm)				
	L	W	T	e min.	g min.
<b>GCM21A</b>	2.0 ±0.2	1.25 ±0.2	1.0 +0, -0.3	0.3	0.7
<b>GCM21B</b>			1.25 ±0.2		
<b>GCM31A</b>	3.2 ±0.2	1.6 ±0.2	1.0 +0, -0.3		1.5
<b>GCM31B</b>			1.25 +0, -0.3		
<b>GCM32A</b>	3.2 ±0.2	2.5 ±0.2	1.0 +0, -0.3		

### ■ Applications

Ideal for use on high frequency pulse circuits such as snubber circuits for DC-DC converters.

Part Number	Rated Voltage (V)	TC Code (Standard)	Capacitance (pF)	Length L (mm)	Width W (mm)	Thickness T (mm)	Electrode g min. (mm)	Electrode e (mm)
<b>GCM21A7U2E101JX01D</b>	DC250	U2J (EIA)	100 ±5%	2.0	1.25	1.0	0.7	0.3 min.
<b>GCM21A7U2E121JX01D</b>	DC250	U2J (EIA)	120 ±5%	2.0	1.25	1.0	0.7	0.3 min.
<b>GCM21A7U2E151JX01D</b>	DC250	U2J (EIA)	150 ±5%	2.0	1.25	1.0	0.7	0.3 min.
<b>GCM21A7U2E181JX01D</b>	DC250	U2J (EIA)	180 ±5%	2.0	1.25	1.0	0.7	0.3 min.
<b>GCM21A7U2E221JX01D</b>	DC250	U2J (EIA)	220 ±5%	2.0	1.25	1.0	0.7	0.3 min.
<b>GCM21A7U2E271JX01D</b>	DC250	U2J (EIA)	270 ±5%	2.0	1.25	1.0	0.7	0.3 min.
<b>GCM21A7U2E331JX01D</b>	DC250	U2J (EIA)	330 ±5%	2.0	1.25	1.0	0.7	0.3 min.
<b>GCM21A7U2E391JX01D</b>	DC250	U2J (EIA)	390 ±5%	2.0	1.25	1.0	0.7	0.3 min.
<b>GCM21A7U2E471JX01D</b>	DC250	U2J (EIA)	470 ±5%	2.0	1.25	1.0	0.7	0.3 min.
<b>GCM21A7U2E561JX01D</b>	DC250	U2J (EIA)	560 ±5%	2.0	1.25	1.0	0.7	0.3 min.
<b>GCM21A7U2E681JX01D</b>	DC250	U2J (EIA)	680 ±5%	2.0	1.25	1.0	0.7	0.3 min.
<b>GCM21A7U2E821JX01D</b>	DC250	U2J (EIA)	820 ±5%	2.0	1.25	1.0	0.7	0.3 min.
<b>GCM21A7U2E102JX01D</b>	DC250	U2J (EIA)	1000 ±5%	2.0	1.25	1.0	0.7	0.3 min.
<b>GCM21A7U2E122JX01D</b>	DC250	U2J (EIA)	1200 ±5%	2.0	1.25	1.0	0.7	0.3 min.
<b>GCM21A7U2E152JX01D</b>	DC250	U2J (EIA)	1500 ±5%	2.0	1.25	1.0	0.7	0.3 min.
<b>GCM21A7U2E182JX01D</b>	DC250	U2J (EIA)	1800 ±5%	2.0	1.25	1.0	0.7	0.3 min.
<b>GCM21A7U2E222JX01D</b>	DC250	U2J (EIA)	2200 ±5%	2.0	1.25	1.0	0.7	0.3 min.
<b>GCM21B7U2E272JX03L</b>	DC250	U2J (EIA)	2700 ±5%	2.0	1.25	1.25	0.7	0.3 min.
<b>GCM31A7U2E272JX01D</b>	DC250	U2J (EIA)	2700 ±5%	3.2	1.6	1.0	1.5	0.3 min.
<b>GCM21B7U2E332JX03L</b>	DC250	U2J (EIA)	3300 ±5%	2.0	1.25	1.25	0.7	0.3 min.
<b>GCM31A7U2E332JX01D</b>	DC250	U2J (EIA)	3300 ±5%	3.2	1.6	1.0	1.5	0.3 min.
<b>GCM21B7U2E392JX03L</b>	DC250	U2J (EIA)	3900 ±5%	2.0	1.25	1.25	0.7	0.3 min.
<b>GCM31A7U2E392JX01D</b>	DC250	U2J (EIA)	3900 ±5%	3.2	1.6	1.0	1.5	0.3 min.
<b>GCM21B7U2E472JX03L</b>	DC250	U2J (EIA)	4700 ±5%	2.0	1.25	1.25	0.7	0.3 min.
<b>GCM31A7U2E472JX01D</b>	DC250	U2J (EIA)	4700 ±5%	3.2	1.6	1.0	1.5	0.3 min.
<b>GCM21B7U2E562JX03L</b>	DC250	U2J (EIA)	5600 ±5%	2.0	1.25	1.25	0.7	0.3 min.
<b>GCM31A7U2E562JX01D</b>	DC250	U2J (EIA)	5600 ±5%	3.2	1.6	1.0	1.5	0.3 min.
<b>GCM31B7U2E682JX01L</b>	DC250	U2J (EIA)	6800 ±5%	3.2	1.6	1.25	1.5	0.3 min.
<b>GCM31B7U2E822JX01L</b>	DC250	U2J (EIA)	8200 ±5%	3.2	1.6	1.25	1.5	0.3 min.
<b>GCM31B7U2E103JX01L</b>	DC250	U2J (EIA)	10000 ±5%	3.2	1.6	1.25	1.5	0.3 min.
<b>GCM31A7U2J100JX01D</b>	DC630	U2J (EIA)	10 ±5%	3.2	1.6	1.0	1.5	0.3 min.
<b>GCM31A7U2J120JX01D</b>	DC630	U2J (EIA)	12 ±5%	3.2	1.6	1.0	1.5	0.3 min.
<b>GCM31A7U2J150JX01D</b>	DC630	U2J (EIA)	15 ±5%	3.2	1.6	1.0	1.5	0.3 min.

Continued on the following page.

 Continued from the preceding page.

Part Number	Rated Voltage (V)	TC Code (Standard)	Capacitance (pF)	Length L (mm)	Width W (mm)	Thickness T (mm)	Electrode g min. (mm)	Electrode e (mm)
GCM31A7U2J180JX01D	DC630	U2J (EIA)	18 ±5%	3.2	1.6	1.0	1.5	0.3 min.
GCM31A7U2J220JX01D	DC630	U2J (EIA)	22 ±5%	3.2	1.6	1.0	1.5	0.3 min.
GCM31A7U2J270JX01D	DC630	U2J (EIA)	27 ±5%	3.2	1.6	1.0	1.5	0.3 min.
GCM31A7U2J330JX01D	DC630	U2J (EIA)	33 ±5%	3.2	1.6	1.0	1.5	0.3 min.
GCM31A7U2J390JX01D	DC630	U2J (EIA)	39 ±5%	3.2	1.6	1.0	1.5	0.3 min.
GCM31A7U2J470JX01D	DC630	U2J (EIA)	47 ±5%	3.2	1.6	1.0	1.5	0.3 min.
GCM31A7U2J560JX01D	DC630	U2J (EIA)	56 ±5%	3.2	1.6	1.0	1.5	0.3 min.
GCM31A7U2J680JX01D	DC630	U2J (EIA)	68 ±5%	3.2	1.6	1.0	1.5	0.3 min.
GCM31A7U2J820JX01D	DC630	U2J (EIA)	82 ±5%	3.2	1.6	1.0	1.5	0.3 min.
GCM31A7U2J101JX01D	DC630	U2J (EIA)	100 ±5%	3.2	1.6	1.0	1.5	0.3 min.
GCM31A7U2J121JX01D	DC630	U2J (EIA)	120 ±5%	3.2	1.6	1.0	1.5	0.3 min.
GCM31A7U2J151JX01D	DC630	U2J (EIA)	150 ±5%	3.2	1.6	1.0	1.5	0.3 min.
GCM31A7U2J181JX01D	DC630	U2J (EIA)	180 ±5%	3.2	1.6	1.0	1.5	0.3 min.
GCM31A7U2J221JX01D	DC630	U2J (EIA)	220 ±5%	3.2	1.6	1.0	1.5	0.3 min.
GCM31A7U2J271JX01D	DC630	U2J (EIA)	270 ±5%	3.2	1.6	1.0	1.5	0.3 min.
GCM31A7U2J331JX01D	DC630	U2J (EIA)	330 ±5%	3.2	1.6	1.0	1.5	0.3 min.
GCM31A7U2J391JX01D	DC630	U2J (EIA)	390 ±5%	3.2	1.6	1.0	1.5	0.3 min.
GCM31A7U2J471JX01D	DC630	U2J (EIA)	470 ±5%	3.2	1.6	1.0	1.5	0.3 min.
GCM31A7U2J561JX01D	DC630	U2J (EIA)	560 ±5%	3.2	1.6	1.0	1.5	0.3 min.
GCM31A7U2J681JX01D	DC630	U2J (EIA)	680 ±5%	3.2	1.6	1.0	1.5	0.3 min.
GCM31A7U2J821JX01D	DC630	U2J (EIA)	820 ±5%	3.2	1.6	1.0	1.5	0.3 min.
GCM31A7U2J102JX01D	DC630	U2J (EIA)	1000 ±5%	3.2	1.6	1.0	1.5	0.3 min.
GCM32A7U2J122JX01D	DC630	U2J (EIA)	1200 ±5%	3.2	2.5	1.0	1.5	0.3 min.
GCM32A7U2J152JX01D	DC630	U2J (EIA)	1500 ±5%	3.2	2.5	1.0	1.5	0.3 min.
GCM32A7U2J182JX01D	DC630	U2J (EIA)	1800 ±5%	3.2	2.5	1.0	1.5	0.3 min.
GCM32A7U2J222JX01D	DC630	U2J (EIA)	2200 ±5%	3.2	2.5	1.0	1.5	0.3 min.

## Specifications and Test Methods

2

No.	AEC-Q200 Test Item	Specifications	AEC-Q200 Test Method															
1	Pre-and Post-Stress Electrical Test	-																
2	High Temperature Exposure (Storage)	The measured and observed characteristics should satisfy the specifications in the following table.	Sit the capacitor for 1000±12 hours at 150±3°C. Let sit for 24±2 hours at room temperature, then measure.															
	Appearance	No marking defects																
	Capacitance Change	Within ±2.5% or ±0.25pF (Whichever is larger)																
	Q	Q≥1000																
3	Temperature Cycle	The measured and observed characteristics should satisfy the specifications in the following table.	Fix the capacitor to the supporting jig in the same manner and under the same conditions as (19). Perform the 1000 cycles according to the 4 heat treatments listed in the following table. Let sit for 24±2 hours at room temperature, then measure. <table border="1" style="margin-top: 10px; width: 100%; border-collapse: collapse;"> <thead> <tr> <th>Step</th> <th>1</th> <th>2</th> <th>3</th> <th>4</th> </tr> </thead> <tbody> <tr> <td>Temp. (°C)</td> <td>-55+0/-3</td> <td>Room Temp.</td> <td>125+3/-0</td> <td>Room Temp.</td> </tr> <tr> <td>Time (min.)</td> <td>15±3</td> <td>1</td> <td>15±3</td> <td>1</td> </tr> </tbody> </table>	Step	1	2	3	4	Temp. (°C)	-55+0/-3	Room Temp.	125+3/-0	Room Temp.	Time (min.)	15±3	1	15±3	1
	Step	1		2	3	4												
	Temp. (°C)	-55+0/-3		Room Temp.	125+3/-0	Room Temp.												
	Time (min.)	15±3		1	15±3	1												
Appearance	No marking defects																	
Capacitance Change	Within ±2.5% or ±0.25pF (Whichever is larger)																	
I.R.	More than 10,000MΩ or 500MΩ · μF (Whichever is smaller)																	
4	Destructive Physical Analysis	No defects or abnormalities	Per EIA-469															
5	Moisture Resistance	The measured and observed characteristics should satisfy the specifications in the following table.	Apply the 24 hour heat (25 to 65°C) and humidity (80 to 98%) treatment shown below, 10 consecutive times. Let sit for 24±2 hours at room temperature, then measure. <div style="text-align: center; margin-top: 10px;"> <p style="font-size: small;">One cycle 24 hours</p> </div>															
	Appearance	No marking defects																
	Capacitance Change	Within ±3.0% or ±0.3pF (Whichever is larger)																
	Q	Q≥350																
6	Biased Humidity	The measured and observed characteristics should satisfy the specifications in the following table.	Apply the rated voltage and DC1.3+0.2/-0V (add 6.8kΩ resistor) at 85±3°C and 80 to 85% humidity for 1000±12 hours. Remove and let sit for 24±2 hours at room temperature, then measure. The charge/discharge current is less than 50mA.															
	Appearance	No marking defects																
	Capacitance Change	Within ±3.0% or ±0.3pF (Whichever is larger)																
	Q	Q≥200																
7	Operational Life	The measured and observed characteristics should satisfy the specifications in the following table.	Apply voltage as Table for 1000±12 hours at 125±3°C. Let sit for 24±2 hours at room temperature, then measure. <table border="1" style="margin-top: 10px; width: 100%; border-collapse: collapse;"> <thead> <tr> <th>Rated Voltage</th> <th>Applied Voltage</th> </tr> </thead> <tbody> <tr> <td>DC250V</td> <td>150% of the rated voltage</td> </tr> <tr> <td>DC630V</td> <td>120% of the rated voltage</td> </tr> </tbody> </table> The charge/discharge current is less than 50mA.	Rated Voltage	Applied Voltage	DC250V	150% of the rated voltage	DC630V	120% of the rated voltage									
	Rated Voltage	Applied Voltage																
	DC250V	150% of the rated voltage																
	DC630V	120% of the rated voltage																
Appearance	No marking defects																	
Capacitance Change	Within ±3.0% or ±0.3pF (Whichever is larger)																	
I.R.	More than 1,000MΩ or 50MΩ · μF (Whichever is smaller)																	
8	External Visual	No defects or abnormalities	Visual inspection															
9	Physical Dimension	Within the specified dimensions	Using calipers and micrometers															

Continued on the following page.

## Specifications and Test Methods

Continued from the preceding page.

No.	AEC-Q200 Test Item	Specifications	AEC-Q200 Test Method
10	Resistance to Solvents	Appearance	No marking defects
		Capacitance Change	Within the specified tolerance
		Q	$Q \geq 1000$
		I.R.	More than 10,000M $\Omega$ or 500M $\Omega \cdot \mu\text{F}$ (Whichever is smaller)
11	Mechanical Shock	Appearance	No marking defects
		Capacitance Change	Within the specified tolerance
		Q	$Q \geq 1000$
		I.R.	More than 10,000M $\Omega$ or 500M $\Omega \cdot \mu\text{F}$ (Whichever is smaller)
12	Vibration	Appearance	No defects or abnormalities
		Capacitance Change	Within the specified tolerance
		Q	$Q \geq 1000$
		I.R.	More than 10,000M $\Omega$ or 500M $\Omega \cdot \mu\text{F}$ (Whichever is smaller)
13	Resistance to Soldering Heat	The measured and observed characteristics should satisfy the specifications in the following table.	
		Appearance	No marking defects
		Capacitance Change	Within the specified tolerance
		Q	$Q \geq 1000$
14	Thermal Shock	The measured and observed characteristics should satisfy the specifications in the following table.	
		Appearance	No marking defects
		Capacitance Change	Within $\pm 2.5\%$ or $\pm 0.25\text{pF}$ (Whichever is larger)
		Q	$Q \geq 1000$
15	ESD	Appearance	No marking defects
		Capacitance Change	Within the specified tolerance
		Q	$Q \geq 1000$
		I.R.	More than 10,000M $\Omega$ or 500M $\Omega \cdot \mu\text{F}$ (Whichever is smaller)
16	Solderability	95% of the terminations is to be soldered evenly and continuously.	
		(a) Preheat at 155°C for 4 hours. After preheating, immerse the capacitor in a solution of ethanol (JIS-K-8101) and rosin (JIS-K-5902) (25% rosin in weight proportion). Immerse in eutectic solder solution for 5+0/-0.5 seconds at 235±5°C.	
		(b) Should be placed into steam aging for 8 hours±15 minutes. After preheating, immerse the capacitor in a solution of ethanol (JIS-K-8101) and rosin (JIS-K-5902) (25% rosin in weight proportion). Immerse in eutectic solder solution for 5+0/-0.5 seconds at 235±5°C.	
		(c) Should be placed into steam aging for 8 hours±15 minutes. After preheating, immerse the capacitor in a solution of ethanol (JIS-K-8101) and rosin (JIS-K-5902) (25% rosin in weight proportion). Immerse in eutectic solder solution for 120 ±5 seconds at 260±5°C.	

Continued on the following page. 

## Specifications and Test Methods

Continued from the preceding page.

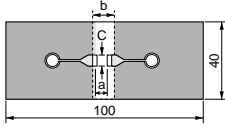
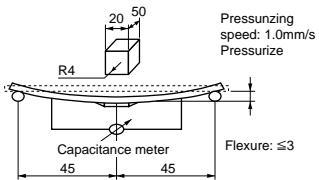
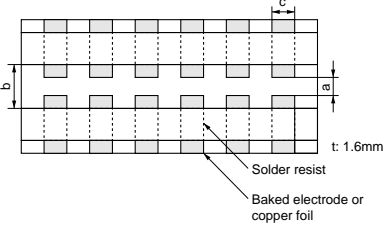
No.	AEC-Q200 Test Item	Specifications	AEC-Q200 Test Method																
17	Electrical Characterization	Appearance	No defects or abnormalities	Visual inspection.															
		Capacitance Change	Within the specified tolerance	The capacitance/Q should be measured at 25°C at the frequency and voltage shown in the table.															
		Q	$Q \geq 1000$	<table border="1" style="width: 100%; border-collapse: collapse;"> <thead> <tr> <th>Capacitance</th> <th>Frequency</th> <th>Voltage</th> </tr> </thead> <tbody> <tr> <td><math>C &lt; 1000\text{pF}</math></td> <td><math>1 \pm 0.2\text{MHz}</math></td> <td><math>AC 0.5 \text{ to } 5V(\text{r.m.s.})</math></td> </tr> <tr> <td><math>C \geq 1000\text{pF}</math></td> <td><math>1 \pm 0.2\text{kHz}</math></td> <td><math>AC 1 \pm 0.2V(\text{r.m.s.})</math></td> </tr> </tbody> </table>	Capacitance	Frequency	Voltage	$C < 1000\text{pF}$	$1 \pm 0.2\text{MHz}$	$AC 0.5 \text{ to } 5V(\text{r.m.s.})$	$C \geq 1000\text{pF}$	$1 \pm 0.2\text{kHz}$	$AC 1 \pm 0.2V(\text{r.m.s.})$						
		Capacitance	Frequency	Voltage															
		$C < 1000\text{pF}$	$1 \pm 0.2\text{MHz}$	$AC 0.5 \text{ to } 5V(\text{r.m.s.})$															
$C \geq 1000\text{pF}$	$1 \pm 0.2\text{kHz}$	$AC 1 \pm 0.2V(\text{r.m.s.})$																	
I.R.	25°C More than 100,000MΩ or 1,000MΩ · μF (Whichever is smaller)  Max. Operating Temperature...125°C More than 10,000MΩ or 100MΩ · μF (Whichever is smaller)	The insulation resistance should be measured with a DC voltage not exceeding the rated voltage at 25°C and 125°C and within 2 minutes of charging.																	
Dielectric Strength	No failure	No failure should be observed when voltage in Table is applied between the terminations for 1 to 5 seconds, provided the charge/discharge current is less than 50mA. <table border="1" style="width: 100%; border-collapse: collapse;"> <thead> <tr> <th>Rated Voltage</th> <th>Test Voltage</th> </tr> </thead> <tbody> <tr> <td>DC250V</td> <td>200% of the rated voltage</td> </tr> <tr> <td>DC630V</td> <td>150% of the rated voltage</td> </tr> </tbody> </table>	Rated Voltage	Test Voltage	DC250V	200% of the rated voltage	DC630V	150% of the rated voltage											
Rated Voltage	Test Voltage																		
DC250V	200% of the rated voltage																		
DC630V	150% of the rated voltage																		
18	Board Flex	Appearance	No marking defects	Solder the capacitor on the test jig (glass epoxy board) shown in Fig. 1 using a eutectic solder. Then apply a force in the direction shown in Fig. 2 for 5±1 seconds. The soldering should be done by the reflow method and should be conducted with care so that the soldering is uniform and free of defects such as heat shock.															
		Capacitance Change	Within ±5.0% or ±0.5pF (Whichever is larger)																
		 <p>Fig. 1</p>	 <p>Fig. 2</p>																
19	Terminal Strength	Appearance	No marking defects	Solder the capacitor to the test jig (glass epoxy board) shown in Fig. 3 using a eutectic solder. Then apply 18N force in parallel with the test jig for 60 seconds. The soldering should be done by the reflow method and should be conducted with care so that the soldering is uniform and free of defects such as heat shock.															
		Capacitance Change	Within the specified tolerance																
		Q	$Q \geq 1000$																
		 <p>Fig. 3</p>	<table border="1" style="width: 100%; border-collapse: collapse;"> <thead> <tr> <th>Type</th> <th>a</th> <th>b</th> <th>c</th> </tr> </thead> <tbody> <tr> <td><b>GCM21</b></td> <td>0.8</td> <td>3.0</td> <td>1.3</td> </tr> <tr> <td><b>GCM31</b></td> <td>2.0</td> <td>4.4</td> <td>1.7</td> </tr> <tr> <td><b>GCM32</b></td> <td>2.0</td> <td>4.4</td> <td>2.6</td> </tr> </tbody> </table> <p style="text-align: right;">(in mm)</p>	Type	a	b	c	<b>GCM21</b>	0.8	3.0	1.3	<b>GCM31</b>	2.0	4.4	1.7	<b>GCM32</b>	2.0	4.4	2.6
Type	a	b	c																
<b>GCM21</b>	0.8	3.0	1.3																
<b>GCM31</b>	2.0	4.4	1.7																
<b>GCM32</b>	2.0	4.4	2.6																

Continued on the following page.

## Specifications and Test Methods

Continued from the preceding page.

No.	AEC-Q200 Test Item	Specifications	AEC-Q200 Test Method												
20	Beam Load Test	The chip endure following force. < Chip L dimension: 2.5mm max. > Chip thickness > 0.5mm rank: 20N Chip thickness ≤ 0.5mm rank: 8N < Chip L dimension: 3.2mm min. > Chip thickness < 1.25mm rank: 15N Chip thickness ≥ 1.25mm rank: 54.5N	Place the capacitor in the beam load fixture as Fig. 4. Apply a force. < Chip L dimension: 2.5mm max. >												
			< Chip L dimension: 3.2mm min. >												
21	Capacitance Temperature Characteristics	Capacitance Change	The capacitance change should be measured after 5 minutes at each specified temperature stage. The temperature coefficient is determined using the capacitance measured in step 3 as a reference. When cycling the temperature sequentially from step1 through 5 the capacitance should be within the specified tolerance for the temperature coefficient. The capacitance drift is calculated by dividing the differences between the maximum and minimum measured values in steps 1, 3 and 5 by the capacitance value in step 3.												
		Capacitance Drift													
Fig. 4 Speed supplied the Stress Load: 2.5mm / s			<table border="1"> <thead> <tr> <th>Step</th> <th>Temperature (°C)</th> </tr> </thead> <tbody> <tr> <td>1</td> <td>25±2</td> </tr> <tr> <td>2</td> <td>-55±3</td> </tr> <tr> <td>3</td> <td>25±2</td> </tr> <tr> <td>4</td> <td>125±3</td> </tr> <tr> <td>5</td> <td>25±2</td> </tr> </tbody> </table>	Step	Temperature (°C)	1	25±2	2	-55±3	3	25±2	4	125±3	5	25±2
Step	Temperature (°C)														
1	25±2														
2	-55±3														
3	25±2														
4	125±3														
5	25±2														

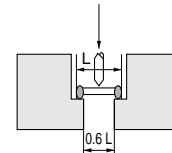
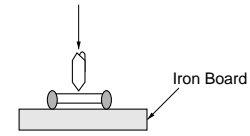

Fig. 4

Speed supplied the Stress Load: 2.5mm / s

# Chip Monolithic Ceramic Capacitors for Automotive



## Medium Voltage for Automotive GCJ Series Soft Termination Type

### ■ Features

1. The GCJ series meet AEC-Q200 requirements.
2. Improve the endurance against Board Bending Stress.
3. Reduce the board bending stress by the conductive polymer termination.
4. Use the GCJ31 type with flow or reflow soldering, and other types with reflow soldering only.

### ■ Applications

Automotive electronic equipment (Power-train, safety equipment)

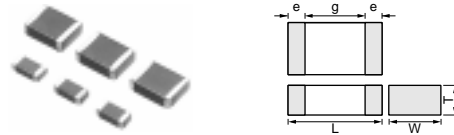

Part Number	Dimensions (mm)				
	L	W	T	e	g min.
<b>GCJ31B</b>	3.2 ±0.2	1.6 ±0.2	1.25 +0,-0.3	0.3 min.	1.2
<b>GCJ31C</b>			1.6 ±0.2		
<b>GCJ32Q</b>	3.2 ±0.3	2.5 ±0.2	1.5 +0,-0.3		
<b>GCJ32D</b>			2.0 +0,-0.3		
<b>GCJ43Q</b>	4.5 ±0.4	3.2 ±0.3	1.5 +0,-0.3		2.2
<b>GCJ43D</b>			2.0 +0,-0.3		
<b>GCJ55D</b>	5.7 ±0.4	5.0 ±0.4	2.0 +0,-0.3	3.2	

Part Number	Rated Voltage (V)	TC Code (Standard)	Capacitance	Length L (mm)	Width W (mm)	Thickness T (mm)	Electrode g min. (mm)	Electrode e (mm)
<b>GCJ31BR72E153KXJ1L</b>	DC250	X7R (EIA)	15000pF ±10%	3.2	1.6	1.25	1.2	0.3 min.
<b>GCJ31BR72E223KXJ1L</b>	DC250	X7R (EIA)	22000pF ±10%	3.2	1.6	1.25	1.2	0.3 min.
<b>GCJ31CR72E333KXJ3L</b>	DC250	X7R (EIA)	33000pF ±10%	3.2	1.6	1.6	1.2	0.3 min.
<b>GCJ31CR72E473KXJ3L</b>	DC250	X7R (EIA)	47000pF ±10%	3.2	1.6	1.6	1.2	0.3 min.
<b>GCJ32QR72E683KXJ1L</b>	DC250	X7R (EIA)	68000pF ±10%	3.2	2.5	1.5	1.2	0.3 min.
<b>GCJ32DR72E104KXJ1L</b>	DC250	X7R (EIA)	0.10μF ±10%	3.2	2.5	2.0	1.2	0.3 min.
<b>GCJ43QR72E154KXJ1L</b>	DC250	X7R (EIA)	0.15μF ±10%	4.5	3.2	1.5	2.2	0.3 min.
<b>GCJ43DR72E224KXJ1L</b>	DC250	X7R (EIA)	0.22μF ±10%	4.5	3.2	2.0	2.2	0.3 min.
<b>GCJ55DR72E334KXJ1L</b>	DC250	X7R (EIA)	0.33μF ±10%	5.7	5.0	2.0	3.2	0.3 min.
<b>GCJ55DR72E474KXJ1L</b>	DC250	X7R (EIA)	0.47μF ±10%	5.7	5.0	2.0	3.2	0.3 min.
<b>GCJ31BR72J102KXJ1L</b>	DC630	X7R (EIA)	1000pF ±10%	3.2	1.6	1.25	1.2	0.3 min.
<b>GCJ31BR72J152KXJ1L</b>	DC630	X7R (EIA)	1500pF ±10%	3.2	1.6	1.25	1.2	0.3 min.
<b>GCJ31BR72J222KXJ1L</b>	DC630	X7R (EIA)	2200pF ±10%	3.2	1.6	1.25	1.2	0.3 min.
<b>GCJ31BR72J332KXJ1L</b>	DC630	X7R (EIA)	3300pF ±10%	3.2	1.6	1.25	1.2	0.3 min.
<b>GCJ31BR72J472KXJ1L</b>	DC630	X7R (EIA)	4700pF ±10%	3.2	1.6	1.25	1.2	0.3 min.
<b>GCJ32QR72J682KXJ1L</b>	DC630	X7R (EIA)	6800pF ±10%	3.2	2.5	1.5	1.2	0.3 min.
<b>GCJ32QR72J103KXJ1L</b>	DC630	X7R (EIA)	10000pF ±10%	3.2	2.5	1.5	1.2	0.3 min.
<b>GCJ32DR72J153KXJ1L</b>	DC630	X7R (EIA)	15000pF ±10%	3.2	2.5	2.0	1.2	0.3 min.
<b>GCJ32DR72J223KXJ1L</b>	DC630	X7R (EIA)	22000pF ±10%	3.2	2.5	2.0	1.2	0.3 min.
<b>GCJ43DR72J333KXJ1L</b>	DC630	X7R (EIA)	33000pF ±10%	4.5	3.2	2.0	2.2	0.3 min.
<b>GCJ43DR72J473KXJ1L</b>	DC630	X7R (EIA)	47000pF ±10%	4.5	3.2	2.0	2.2	0.3 min.
<b>GCJ55DR72J104KXJ1L</b>	DC630	X7R (EIA)	0.10μF ±10%	5.7	5.0	2.0	3.2	0.3 min.

3

## Specifications and Test Methods

No.	AEC-Q200 Test Item	Specifications	AEC-Q200 Test Method															
1	Pre-and Post-Stress Electrical Test	-	-															
2	High Temperature Exposure (Storage)	The measured and observed characteristics should satisfy the specifications in the following table.	Sit the capacitor for 1000±12 hours at 150±3°C. Let sit for 24±2 hours at room temperature, then measure.															
	Appearance	No marking defects																
	Capacitance Change	Within ±10%																
	D.F.	0.05 max.																
3	I.R.	More than 10,000MΩ or 100MΩ · μF (Whichever is smaller)	Fix the capacitor to the supporting jig in the same manner and under the same conditions as (19). Perform the 1000 cycles according to the 4 heat treatments listed in the following table. Let sit for 24±2 hours at room temperature, then measure. <table border="1" style="margin-top: 10px;"> <thead> <tr> <th>Step</th> <th>1</th> <th>2</th> <th>3</th> <th>4</th> </tr> </thead> <tbody> <tr> <td>Temp. (°C)</td> <td>-55+0/-3</td> <td>Room Temp.</td> <td>125+3/-0</td> <td>Room Temp.</td> </tr> <tr> <td>Time (min.)</td> <td>15±3</td> <td>1</td> <td>15±3</td> <td>1</td> </tr> </tbody> </table> •Pretreatment Perform the heat treatment at 150+0/-10°C for 60±5 minutes and then let sit for 24±2 hours at room temperature.	Step	1	2	3	4	Temp. (°C)	-55+0/-3	Room Temp.	125+3/-0	Room Temp.	Time (min.)	15±3	1	15±3	1
	Step	1		2	3	4												
	Temp. (°C)	-55+0/-3		Room Temp.	125+3/-0	Room Temp.												
	Time (min.)	15±3		1	15±3	1												
Temperature Cycle	The measured and observed characteristics should satisfy the specifications in the following table.																	
Appearance	No marking defects																	
Capacitance Change	Within ±10%																	
D.F.	0.05 max.																	
I.R.	More than 10,000MΩ or 100MΩ · μF (Whichever is smaller)																	
4	Destructive Physical Analysis	No defects or abnormalities	Per EIA-469															
5	Moisture Resistance	The measured and observed characteristics should satisfy the specifications in the following table.	Apply the 24 hour heat (25 to 65°C) and humidity (80 to 98%) treatment shown below, 10 consecutive times. Let sit for 24±2 hours at room temperature, then measure. <div style="text-align: center; margin-top: 10px;"> </div>															
	Appearance	No marking defects																
	Capacitance Change	Within ±12.5%																
	D.F.	0.05 max.																
I.R.	More than 10,000MΩ or 100MΩ · μF (Whichever is smaller)																	
6	Biased Humidity	The measured and observed characteristics should satisfy the specifications in the following table.	Apply the rated voltage and DC1.3+0.2/-0V (add 6.8kΩ resistor) at 85±3°C and 80 to 85% humidity for 1000±12 hours. Remove and let sit for 24±2 hours at room temperature, then measure. The charge/discharge current is less than 50mA. •Pretreatment Perform the heat treatment at 150+0/-10°C for 60±5 minutes and then let sit for 24±2 hours at room temperature.															
	Appearance	No marking defects																
	Capacitance Change	Within ±12.5%																
	D.F.	0.05 max.																
I.R.	More than 1,000MΩ or 10MΩ · μF (Whichever is smaller)																	
7	Operational Life	The measured and observed characteristics should satisfy the specifications in the following table.	Apply voltage in Table for 1000±12 hours at 125±3°C. Let sit for 24±2 hours at room temperature, then measure. The charge/discharge current is less than 50mA. <table border="1" style="margin-top: 10px; width: 100%;"> <thead> <tr> <th>Rated Voltage</th> <th>Applied Voltage</th> </tr> </thead> <tbody> <tr> <td>DC250V</td> <td>150% of the rated voltage</td> </tr> <tr> <td>DC630V</td> <td>120% of the rated voltage</td> </tr> </tbody> </table> •Pretreatment Apply test voltage for 60±5 minutes at test temperature. Remove and let sit for 24±2 hours at room temperature.	Rated Voltage	Applied Voltage	DC250V	150% of the rated voltage	DC630V	120% of the rated voltage									
	Rated Voltage	Applied Voltage																
	DC250V	150% of the rated voltage																
	DC630V	120% of the rated voltage																
Appearance	No marking defects																	
Capacitance Change	Within ±12.5%																	
D.F.	0.05 max.																	
I.R.	More than 1,000MΩ or 10MΩ · μF (Whichever is smaller)																	
8	External Visual	No defects or abnormalities	Visual inspection															
9	Physical Dimension	Within the specified dimensions	Using calipers and micrometers															

Continued on the following page.



## Specifications and Test Methods

Continued from the preceding page.

No.	AEC-Q200 Test Item	Specifications	AEC-Q200 Test Method										
10	Resistance to Solvents	Appearance	No marking defects	Per MIL-STD-202 Method 215 Solvent 1: 1 part (by volume) of isopropyl alcohol 3 parts (by volume) of mineral spirits Solvent 2: Terpene defluxer Solvent 3: 42 parts (by volume) of water 1 part (by volume) of propylene glycol monomethyl ether 1 part (by volume) of monoethanolamine									
		Capacitance Change	Within the specified tolerance										
		D.F.	0.025 max.										
		I.R.	More than 10,000MΩ or 100MΩ · μF (Whichever is smaller)										
11	Mechanical Shock	Appearance	No marking defects	Three shocks in each direction should be applied along 3 mutually perpendicular axes of the test specimen (18 shocks). The specified test pulse should be Half-sine and should have a duration: 0.5ms, peak value: 1500g and velocity change: 4.7m/s.									
		Capacitance Change	Within the specified tolerance										
		D.F.	0.025 max.										
		I.R.	More than 10,000MΩ or 500MΩ · μF (Whichever is smaller)										
12	Vibration	Appearance	No defects or abnormalities	Solder the capacitor to the test jig (glass epoxy board) in the same manner and under the same conditions as (19). The capacitor should be subjected to a simple harmonic motion having a total amplitude of 1.5mm, the frequency being varied uniformly between the approximate limits of 10 and 2000Hz. The frequency range, from 10 to 2000Hz and return to 10Hz, should be traversed in approximately 20 minutes. This motion should be applied for 12 items in each 3 mutually perpendicular directions (total of 36 times).									
		Capacitance Change	Within the specified tolerance										
		D.F.	0.025 max.										
		I.R.	More than 10,000MΩ or 500MΩ · μF (Whichever is smaller)										
13	Resistance to Soldering Heat	The measured and observed characteristics should satisfy the specifications in the following table.		Immerse the capacitor in a eutectic solder solution at 260±5°C for 10±1 seconds. Let sit at room temperature for 24±2 hours, then measure. •Pretreatment Perform the heat treatment at 150+0/-10°C for 60±5 minutes and then let sit for 24±2 hours at room temperature.									
		Appearance	No marking defects										
		Capacitance Change	Within ±10%										
		D.F.	0.025 max.										
14	Thermal Shock	The measured and observed characteristics should satisfy the specifications in the following table.		Fix the capacitor to the supporting jig in the same manner and under the same conditions as (19). Perform the 300 cycles according to the two heat treatments listed in the following table (Maximum transfer time is 20 seconds). Let sit for 24±2 hours at room temperature, then measure. <table border="1" style="margin: 10px auto; border-collapse: collapse; text-align: center;"> <thead> <tr style="background-color: #f2f2f2;"> <th style="padding: 2px;">Step</th> <th style="padding: 2px;">1</th> <th style="padding: 2px;">2</th> </tr> </thead> <tbody> <tr> <td style="padding: 2px;">Temp. (°C)</td> <td style="padding: 2px;">-55+0/-3</td> <td style="padding: 2px;">125+3/-0</td> </tr> <tr> <td style="padding: 2px;">Time (min.)</td> <td style="padding: 2px;">15±3</td> <td style="padding: 2px;">15±3</td> </tr> </tbody> </table> •Pretreatment Perform the heat treatment at 150+0/-10°C for 60±5 minutes and then let sit for 24±2 hours at room temperature.	Step	1	2	Temp. (°C)	-55+0/-3	125+3/-0	Time (min.)	15±3	15±3
		Step	1		2								
		Temp. (°C)	-55+0/-3		125+3/-0								
		Time (min.)	15±3		15±3								
Appearance	No marking defects												
Capacitance Change	Within ±10%												
D.F.	0.025 max.												
I.R.	More than 10,000MΩ or 100MΩ · μF (Whichever is smaller)												
15	ESD	Appearance	No marking defects	Per AEC-Q200-004									
		Capacitance Change	Within the specified tolerance										
		D.F.	0.025 max.										
		I.R.	More than 10,000MΩ or 100MΩ · μF (Whichever is smaller)										
16	Solderability	95% of the terminations is to be soldered evenly and continuously.		(a) Preheat at 155°C for 4 hours. After preheating, immerse the capacitor in a solution of ethanol (JIS-K-8101) and rosin (JIS-K-5902) (25% rosin in weight proportion). Immerse in eutectic solder solution for 5+0/-0.5 seconds at 235±5°C. (b) Should be placed into steam aging for 8 hours±15 minutes. After preheating, immerse the capacitor in a solution of ethanol (JIS-K-8101) and rosin (JIS-K-5902) (25% rosin in weight proportion). Immerse in eutectic solder solution for 5+0/-0.5 seconds at 235±5°C. (c) Should be placed into steam aging for 8 hours±15 minutes. After preheating, immerse the capacitor in a solution of ethanol (JIS-K-8101) and rosin (JIS-K-5902) (25% rosin in weight proportion). Immerse in eutectic solder solution for 120 ±5 seconds at 260±5°C.									

Continued on the following page.

## Specifications and Test Methods

Continued from the preceding page.

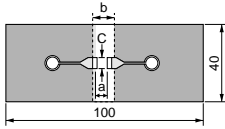
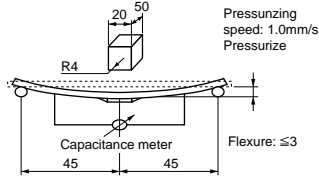
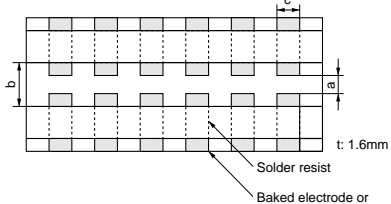
No.	AEC-Q200 Test Item	Specifications	AEC-Q200 Test Method																				
17	Electrical Characterization	Appearance	No defects or abnormalities	Visual inspection.																			
		Capacitance Change	Within the specified tolerance	The capacitance/Q should be measured at 25°C at the frequency and voltage shown in the table.																			
		D.F.	0.025 max.	<table border="1"> <thead> <tr> <th>Capacitance</th> <th>Frequency</th> <th>Voltage</th> </tr> </thead> <tbody> <tr> <td>C&lt;1000pF</td> <td>1±0.2MHz</td> <td>AC0.5 to 5V(r.m.s.)</td> </tr> <tr> <td>C≥1000pF</td> <td>1±0.2kHz</td> <td>AC1±0.2V(r.m.s.)</td> </tr> </tbody> </table>	Capacitance	Frequency	Voltage	C<1000pF	1±0.2MHz	AC0.5 to 5V(r.m.s.)	C≥1000pF	1±0.2kHz	AC1±0.2V(r.m.s.)										
		Capacitance	Frequency	Voltage																			
		C<1000pF	1±0.2MHz	AC0.5 to 5V(r.m.s.)																			
C≥1000pF	1±0.2kHz	AC1±0.2V(r.m.s.)																					
I.R.	25°C More than 10,000MΩ or 100MΩ · μF (Whichever is smaller)  Max. Operating Temperature...125°C More than 1,000MΩ or 10MΩ · μF (Whichever is smaller)	The insulation resistance should be measured with a DC voltage not exceeding the rated voltage at 25°C and 125°C and within 2 minutes of charging.																					
Dielectric Strength	No failure	No failure should be observed when voltage in Table is applied between the terminations for 1 to 5 seconds, provided the charge/discharge current is less than 50mA.																					
		<table border="1"> <thead> <tr> <th>Rated Voltage</th> <th>Test Voltage</th> </tr> </thead> <tbody> <tr> <td>DC250V</td> <td>200% of the rated voltage</td> </tr> <tr> <td>DC630V</td> <td>150% of the rated voltage</td> </tr> </tbody> </table>	Rated Voltage	Test Voltage	DC250V	200% of the rated voltage	DC630V	150% of the rated voltage															
Rated Voltage	Test Voltage																						
DC250V	200% of the rated voltage																						
DC630V	150% of the rated voltage																						
18	Board Flex	Appearance	No marking defects	Solder the capacitor on the test jig (glass epoxy board) shown in Fig. 1 using a eutectic solder. Then apply a force in the direction shown in Fig. 2 for 5±1 seconds. The soldering should be done by the reflow method and should be conducted with care so that the soldering is uniform and free of defects such as heat shock.																			
		Capacitance Change	Within ±12.5%																				
		 <p>Fig. 1</p>	<table border="1"> <thead> <tr> <th>Type</th> <th>a</th> <th>b</th> <th>c</th> </tr> </thead> <tbody> <tr> <td><b>GCJ31</b></td> <td>2.0</td> <td>4.4</td> <td>1.7</td> </tr> <tr> <td><b>GCJ32</b></td> <td>2.0</td> <td>4.4</td> <td>2.6</td> </tr> <tr> <td><b>GCJ43</b></td> <td>3.0</td> <td>6.0</td> <td>3.3</td> </tr> <tr> <td><b>GCJ55</b></td> <td>4.2</td> <td>7.2</td> <td>5.1</td> </tr> </tbody> </table> <p>(in mm)</p>  <p>Fig. 2</p>	Type	a	b	c	<b>GCJ31</b>	2.0	4.4	1.7	<b>GCJ32</b>	2.0	4.4	2.6	<b>GCJ43</b>	3.0	6.0	3.3	<b>GCJ55</b>	4.2	7.2	5.1
Type	a	b	c																				
<b>GCJ31</b>	2.0	4.4	1.7																				
<b>GCJ32</b>	2.0	4.4	2.6																				
<b>GCJ43</b>	3.0	6.0	3.3																				
<b>GCJ55</b>	4.2	7.2	5.1																				
19	Terminal Strength	Appearance	No marking defects	Solder the capacitor to the test jig (glass epoxy board) shown in Fig. 3 using a eutectic solder. Then apply 18N force in parallel with the test jig for 60 seconds. The soldering should be done by the reflow method and should be conducted with care so that the soldering is uniform and free of defects such as heat shock.																			
		Capacitance Change	Within the specified tolerance																				
		D.F.	0.025 max.																				
		I.R.	More than 10,000MΩ or 100MΩ · μF (Whichever is smaller)																				
		<table border="1"> <thead> <tr> <th>Type</th> <th>a</th> <th>b</th> <th>c</th> </tr> </thead> <tbody> <tr> <td><b>GCJ31</b></td> <td>2.2</td> <td>5.0</td> <td>2.0</td> </tr> <tr> <td><b>GCJ32</b></td> <td>2.2</td> <td>5.0</td> <td>2.9</td> </tr> <tr> <td><b>GCJ43</b></td> <td>3.5</td> <td>7.0</td> <td>3.7</td> </tr> <tr> <td><b>GCJ55</b></td> <td>4.5</td> <td>8.0</td> <td>5.6</td> </tr> </tbody> </table> <p>(in mm)</p>  <p>Fig. 3</p>	Type	a	b	c	<b>GCJ31</b>	2.2	5.0	2.0	<b>GCJ32</b>	2.2	5.0	2.9	<b>GCJ43</b>	3.5	7.0	3.7	<b>GCJ55</b>	4.5	8.0	5.6	
Type	a	b	c																				
<b>GCJ31</b>	2.2	5.0	2.0																				
<b>GCJ32</b>	2.2	5.0	2.9																				
<b>GCJ43</b>	3.5	7.0	3.7																				
<b>GCJ55</b>	4.5	8.0	5.6																				

Continued on the following page. ↗

## Specifications and Test Methods

Continued from the preceding page.

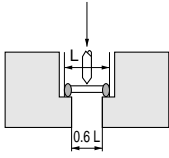
No.	AEC-Q200 Test Item	Specifications	AEC-Q200 Test Method												
20	Beam Load Test	The chip endure following force. Chip thickness < 1.25mm rank: 15N Chip thickness ≥ 1.25mm rank: 54.5N	Place the capacitor in the beam load fixture as Fig. 4. Apply a force. <div style="text-align: center;">  <p>Fig. 4</p> </div> Speed supplied the Stress Load: 2.5mm / s												
21	Capacitance Temperature Characteristics Capacitance Change	Within ±15%	The capacitance change should be measured after 5 minutes at each specified temperature stage. <table border="1" style="margin-left: auto; margin-right: auto;"> <thead> <tr> <th style="text-align: center;">Step</th> <th style="text-align: center;">Temperature (°C)</th> </tr> </thead> <tbody> <tr> <td style="text-align: center;">1</td> <td style="text-align: center;">25±2</td> </tr> <tr> <td style="text-align: center;">2</td> <td style="text-align: center;">-55±3</td> </tr> <tr> <td style="text-align: center;">3</td> <td style="text-align: center;">25±2</td> </tr> <tr> <td style="text-align: center;">4</td> <td style="text-align: center;">125±3</td> </tr> <tr> <td style="text-align: center;">5</td> <td style="text-align: center;">25±2</td> </tr> </tbody> </table> The ranges of capacitance change compared with the above 25°C value over the temperature ranges shown in the table should be within the specified ranges. •Pretreatment Perform the heat treatment at 150+0/-10°C for 60±5 minutes and then let sit for 24±2 hours at room temperature. Perform the initial measurement.	Step	Temperature (°C)	1	25±2	2	-55±3	3	25±2	4	125±3	5	25±2
Step	Temperature (°C)														
1	25±2														
2	-55±3														
3	25±2														
4	125±3														
5	25±2														

3

## Medium Voltage Data (Typical Example)

### ■ Capacitance - Temperature Characteristics

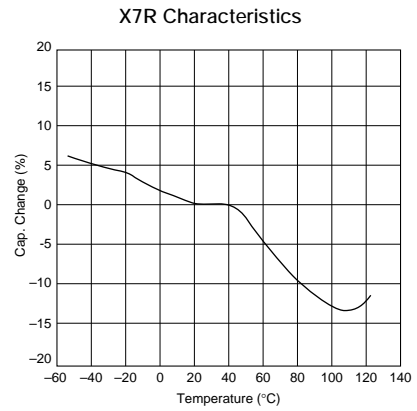
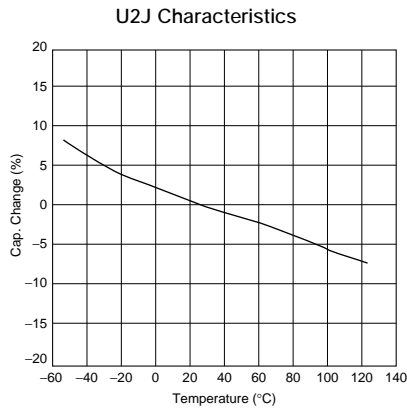

### ■ Impedance - Frequency Characteristics

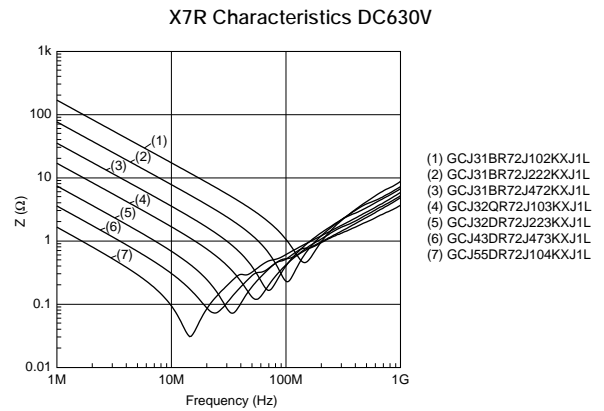
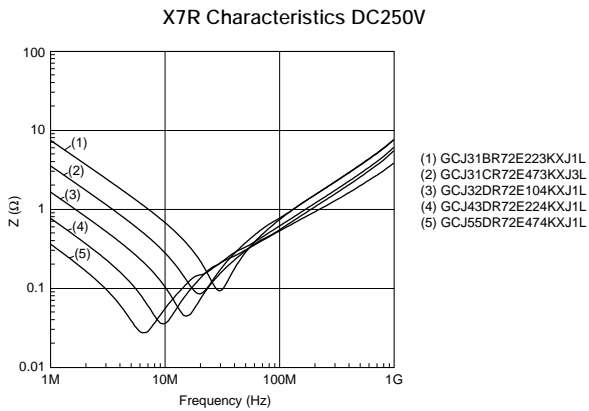

# Package

Taping is standard packaging method.

## Minimum Quantity Guide

Part Number		Dimensions (mm)			Quantity (pcs.)	
					ø180mm Reel	
		L	W	T	Paper Tape	Embossed Tape
Medium Voltage	<b>GCM21</b>	2.0	1.25	1.0	4,000	-
				1.25	-	3,000
	<b>GCJ31/GCM31</b>	3.2	1.6	1.0	4,000	-
				1.25	-	3,000
				1.6	-	2,000
	<b>GCJ32/GCM32</b>	3.2	2.5	1.0	4,000	-
				1.5	-	2,000
				2.0	-	1,000
	<b>GCJ43</b>	4.5	3.2	1.5	-	1,000
				2.0	-	1,000
<b>GCJ55</b>	5.7	5.0	2.0	-	1,000	

## Tape Carrier Packaging

### (1) Appearance of Taping

#### ① Embossed Tape

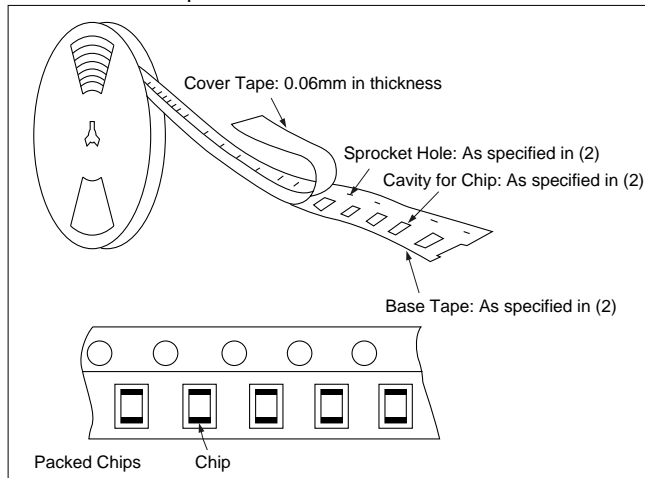

#### ② Paper Tape

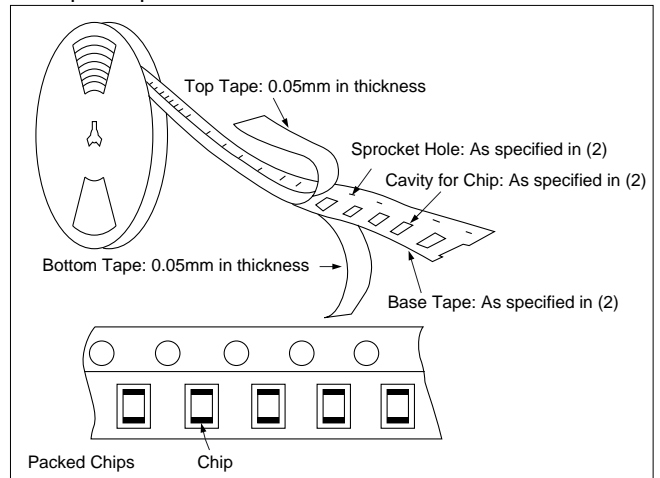

### (2) Dimensions of Tape

#### ① Embossed Tape

**8mm width 4mm pitch Tape**

Part Number	A*	B*
<b>GCM21</b> (T≥1.25mm)	1.45	2.25
<b>GCJ31/GCM31</b> (T≥1.25mm)	2.0	3.6
<b>GCJ32</b> (T≥1.25mm)	2.9	3.6

\*Nominal Value

**12mm width 8mm/4mm pitch Tape**

Part Number	A*	B*
<b>GCJ43</b>	3.6	4.9
<b>GCJ55</b>	5.4	6.1

\*Nominal Value

(in mm)

Continued on the following page.

## Package

Continued from the preceding page.

### ② Paper Tape

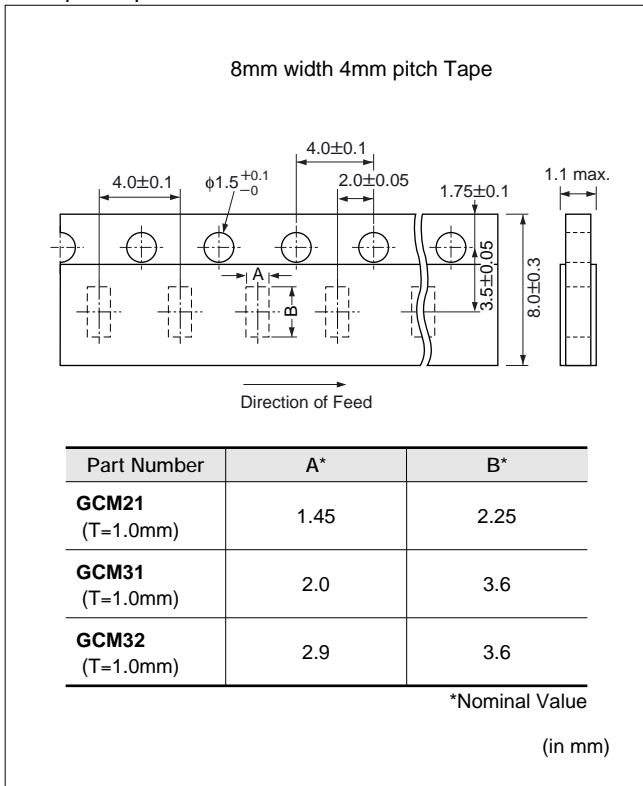

### (3) Dimensions of Reel

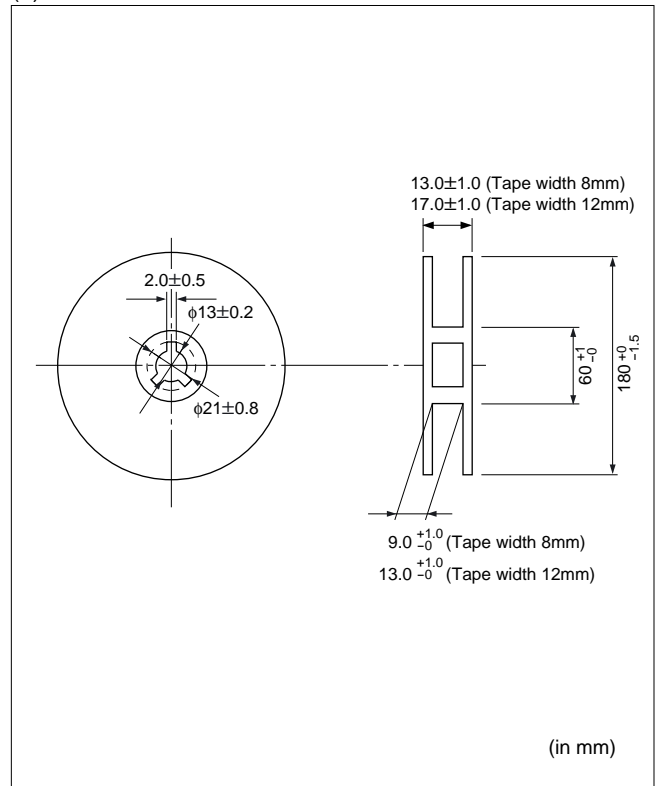

### (4) Taping Method

- ① Tapes for capacitors are wound clockwise. The sprocket holes are to the right as the tape is pulled toward the user.
- ② Part of the leader and part of the empty tape should be attached to the end of the tape as shown at right.
- ③ The top tape or cover tape and base tape are not attached at the end of the tape for a minimum of 5 pitches.
- ④ Missing capacitors number within 0.1% of the number per reel or 1 pc, whichever is greater, and are not continuous.
- ⑤ The top tape or cover tape and bottom tape should not protrude beyond the edges of the tape and should not cover sprocket holes.
- ⑥ Cumulative tolerance of sprocket holes, 10 pitches:  $\pm 0.3\text{mm}$ .
- ⑦ Peeling off force: 0.1 to 0.6N in the direction shown at right.

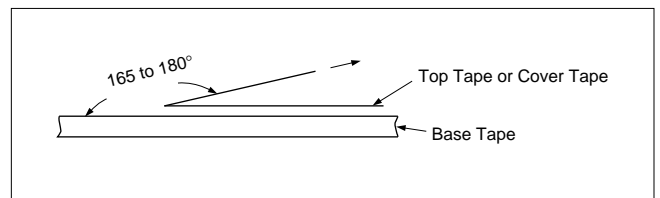
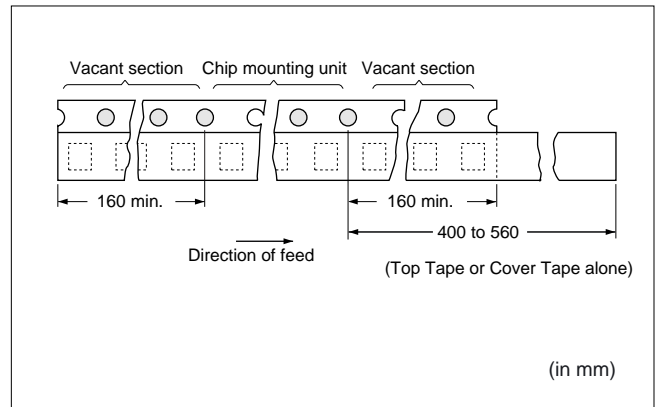



## ■ Storage and Operating Conditions

### Operating and storage environment

Do not use or store capacitors in a corrosive atmosphere, especially where chloride gas, sulfide gas, acid, alkali, salt or the like are present. And avoid exposure to moisture. Before cleaning, bonding or molding this product, verify that these processes do not affect product quality by testing the performance of a cleaned, bonded or molded product in the intended equipment. Store the capacitors where the temperature and relative humidity do not exceed 5 to 40 degrees centigrade and 20 to 70%.

Use capacitors within 6 months after delivered.  
Check the solderability after 6 months or more.

FAILURE TO FOLLOW THE ABOVE CAUTIONS MAY RESULT, WORST CASE, IN A SHORT CIRCUIT AND CAUSE FUMING OR PARTIAL DISPERSION WHEN THE PRODUCT IS USED.

## ■ Handling

### 1. Vibration and impact

Do not expose a capacitor to excessive shock or vibration during use.

### 2. Do not directly touch the chip capacitor, especially the ceramic body. Residue from hands/fingers may create a short circuit environment.

FAILURE TO FOLLOW THE ABOVE CAUTIONS MAY RESULT, WORST CASE, IN A SHORT CIRCUIT AND CAUSE FUMING OR PARTIAL DISPERSION WHEN THE PRODUCT IS USED.

## ⚠ Caution

### ■ Rating

#### 1. Operating Voltage

When DC-rated capacitors are to be used in AC or ripple current circuits, be sure to maintain the  $V_{p-p}$  value of the applied voltage or the  $V_{o-p}$  which contains DC bias within the rated voltage range.

When the voltage is applied to the circuit, starting or stopping may generate irregular voltage for a transit period because of resonance or switching. Be sure to use a capacitor with a rated voltage range that includes these irregular voltages.

When DC-rated capacitors are to be used in input circuits from commercial power source (AC filter), be sure to use Safety Recognized Capacitors because various regulations on withstand voltage or impulse withstand established for each equipment should be taken into considerations.

Voltage	DC Voltage	DC+AC Voltage	AC Voltage	Pulse Voltage (1)	Pulse Voltage (2)
Positional Measurement					

#### 2. Operating Temperature, Self-generated Heat, and Load Reduction at High-frequency Voltage Condition

Keep the surface temperature of a capacitor below the upper limit of its rated operating temperature range.

Be sure to take into account the heat generated by the capacitor itself. When the capacitor is used in a high-frequency voltage, pulse voltage, it may self-generate heat due to dielectric loss.

##### (1) In case of X7R char.

Applied voltage should be the load such as self-generated heat is within  $20^{\circ}\text{C}$  on the condition of atmosphere temperature  $25^{\circ}\text{C}$ . When measuring, use a thermocouple of small thermal capacity -K of  $\phi 0.1\text{mm}$  in conditions where the capacitor is not affected by radiant heat from other components or surrounding ambient fluctuations. Excessive heat may lead to deterioration of the capacitor's characteristics and reliability. (Never attempt to perform measurement with the cooling fan running. Otherwise, accurate measurement cannot be ensured.)

Continued on the following page.





Continued from the preceding page.

(2) In case of U2J char.

Due to the low self-heating characteristics of low-dissipation capacitors, the allowable electric power of these capacitors is generally much higher than that of X7R characteristic capacitors.

When a high frequency voltage which cause 20°C self heating to the capacitor is applied, it will exceed capacitor's allowable electric power.

The frequency of the applied sine wave voltage should be less than 500kHz. The applied voltage should be less than the value shown in figure below.

In case of non-sine wave which includes a harmonic frequency, please contact our sales representatives or product engineers. Excessive heat may lead to deterioration of the capacitor's characteristics and reliability. (Never attempt to perform measurement with the cooling fan running.

Otherwise, accurate measurement cannot be ensured.)

<Capacitor Selection Tool>

We are also offering free software the "capacitor selection tool: Murata Medium Voltage Capacitors Selection Tool by Voltage Form (\*)" which will assist you in selecting a suitable capacitor.

The software can be downloaded from Murata's Internet Web site.

([http://www.murata.com/designlib/mmcsv\\_e.html](http://www.murata.com/designlib/mmcsv_e.html))

By inputting capacitance values and applied voltage waveform of the specific capacitor series, this software will calculate the capacitor's power consumption and list suitable capacitors. (non-sine wave is also available).

\* Subject series are below.

- Temperature Characteristics U2J

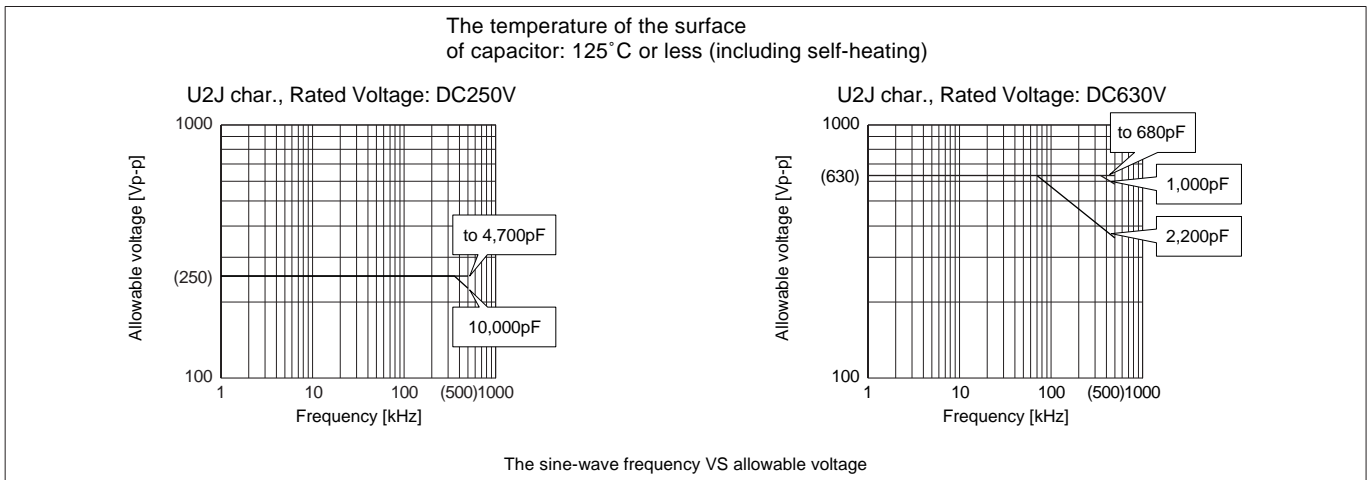

3. Fail-safe

Failure of a capacitor may result in a short circuit. Be sure to provide an appropriate fail-safe function such as a fuse on your product to help eliminate possible electric shock, fire, or fumes.

Please consider using fuses on each AC line if the capacitors are used between the AC input lines and earth (line bypass capacitors), to prepare for the worst case, such as a short circuit.

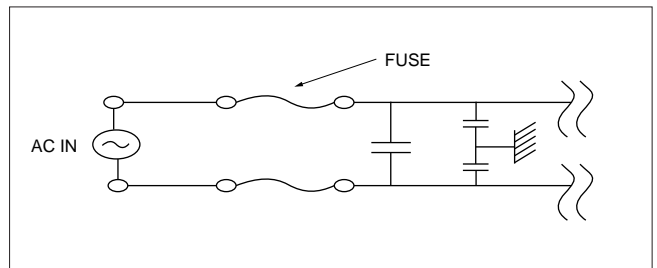

Continued on the following page. ↗

## ⚠ Caution

☐ Continued from the preceding page.

### 4. Test Condition for AC Withstanding Voltage

#### (1) Test Equipment

Tests for AC withstanding voltage should be made with equipment capable of creating a wave similar to a 50/60 Hz sine wave.

If the distorted sine wave or overload exceeding the specified voltage value is applied, a defect may be caused.

#### (2) Voltage Applied Method

The capacitor's leads or terminals should be firmly connected to the output of the withstanding voltage test equipment, and then the voltage should be raised from near zero to the test voltage. If the test voltage is applied directly to the capacitor without raising it from near zero, it should be applied with the zero cross\*. At the end of the test time, the test voltage should be reduced to near zero, and then the capacitor's leads or terminals should be taken off the output of the withstanding voltage test equipment. If the test voltage is applied directly to the capacitor without raising it from near zero, surge voltage may occur and cause a defect.

\*ZERO CROSS is the point where voltage sine wave pass 0V.

- See the figure at right -

FAILURE TO FOLLOW THE ABOVE CAUTIONS MAY RESULT, WORST CASE, IN A SHORT CIRCUIT AND CAUSE FUMING OR PARTIAL DISPERSION WHEN THE PRODUCT IS USED.

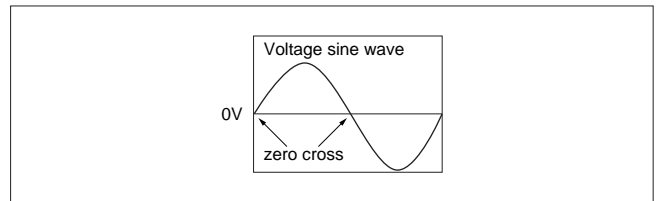



## ■ Solder and Mounting

### 1. Vibration and Impact

Do not expose a capacitor to excessive shock or vibration during use.

### 2. Circuit Board Material

In case that ceramic chip capacitor is soldered on the metal board, such as Aluminum board, the stress of heat expansion and contraction might cause the crack of ceramic capacitor, due to the difference of thermal expansion coefficient between metal board and ceramic chip.

### 3. Land Layout for Cropping PC Board

Choose a mounting position that minimizes the stress imposed on the chip during flexing or bending of the board.

[Component Direction]

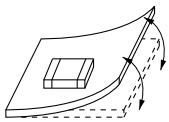

<Examples to be avoided>

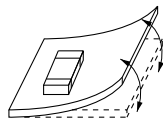

<Examples of improvements>

Locate chip horizontal to the direction in which stress acts.

[Chip Mounting Close to Board Separation Point]

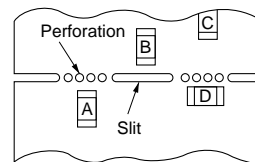

Chip arrangement  
Worst A>C>B~D Best

Continued on the following page.

## Caution

Continued from the preceding page.

### 4. Reflow Soldering

- When the sudden heat is given to the components, the mechanical strength of the components should go down because remarkable temperature change causes deformity of components inside. In order to prevent mechanical damage in the components, preheating should be required for both of the components and the PCB board. Preheating conditions are shown in Table 1. It is required to keep temperature differential between the soldering and the components surface ( $\Delta T$ ) as small as possible.
- Solderability of Tin plating termination chip might be deteriorated when low temperature soldering profile where peak solder temperature is below the Tin melting point is used. Please confirm the solderability of Tin plating termination chip before use.
- When components are immersed in solvent after mounting, be sure to maintain the temperature difference ( $\Delta T$ ) between the component and solvent within the range shown in the Table 1.

Table 1

Part Number	Temperature Differential
G□□21/31	$\Delta T \leq 190^\circ\text{C}$
G□□32/43/55	$\Delta T \leq 130^\circ\text{C}$

#### Recommended Conditions

	Pb-Sn Solder		Lead Free Solder
	Infrared Reflow	Vapor Reflow	
Peak Temperature	230-250°C	230-240°C	240-260°C
Atmosphere	Air	Air	Air or N <sub>2</sub>

Pb-Sn Solder: Sn-37Pb

Lead Free Solder: Sn-3.0Ag-0.5Cu

#### Optimum Solder Amount for Reflow Soldering

- Overly thick application of solder paste results in excessive fillet height solder. This makes the chip more susceptible to mechanical and thermal stress on the board and may cause cracked chips.
- Too little solder paste results in a lack of adhesive strength on the outer electrode, which may result in chips breaking loose from the PCB.
- Make sure the solder has been applied smoothly to the end surface to a height of 0.2mm min.

#### Inverting the PCB

Make sure not to impose an abnormal mechanical shock on the PCB.

#### [Standard Conditions for Reflow Soldering]

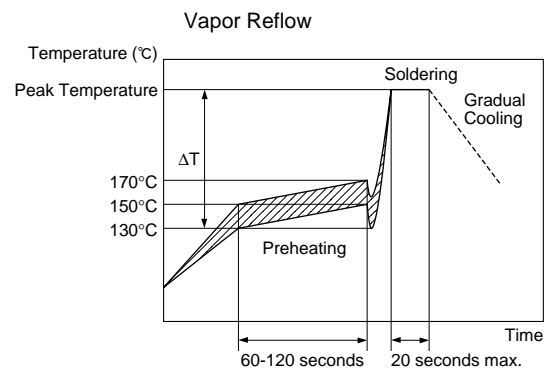
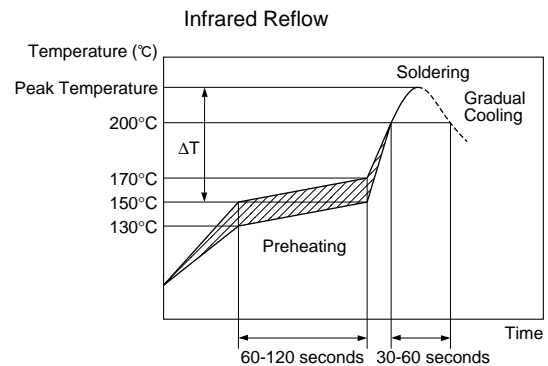

#### [Allowable Soldering Temperature and Time]

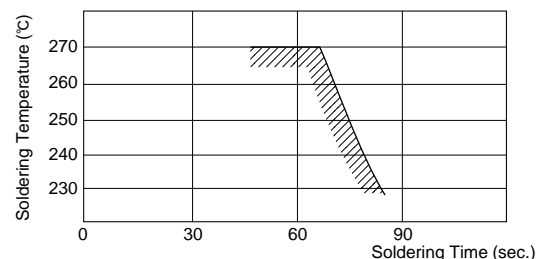

In case of repeated soldering, the accumulated soldering time must be within the range shown above.

#### [Optimum Solder Amount for Reflow Soldering]

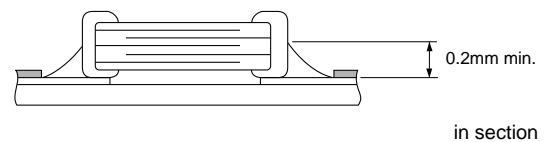



Continued from the preceding page.

### 5. Flow Soldering

- When the sudden heat is given to the components, the mechanical strength of the components should go down because remarkable temperature change causes deformity of components inside. And an excessively long soldering time or high soldering temperature results in leaching by the outer electrodes, causing poor adhesion or a reduction in capacitance value due to loss of contact between electrodes and end termination.
- In order to prevent mechanical damage in the components, preheating should be required for both of the components and the PCB board. Preheating conditions are shown in Table 2. It is required to keep temperature differential between the soldering and the components surface ( $\Delta T$ ) as small as possible.
- When components are immersed in solvent after mounting, be sure to maintain the temperature difference between the component and solvent within the range shown in Table 2.  
Do not apply flow soldering to chips not listed in Table 2.

Table 2

Part Number	Temperature Differential
G□□21/31	$\Delta T \leq 150^\circ\text{C}$

#### Recommended Conditions

	Pb-Sn Solder	Lead Free Solder
Peak Temperature	240-250°C	250-260°C
Atmosphere	Air	N <sub>2</sub>

Pb-Sn Solder: Sn-37Pb  
 Lead Free Solder: Sn-3.0Ag-0.5Cu

- Optimum Solder Amount for Flow Soldering  
 The top of the solder fillet should be lower than the thickness of components. If the solder amount is excessively big, the risk of cracking is higher during board bending or under any other stressful conditions.

[Standard Conditions for Flow Soldering]

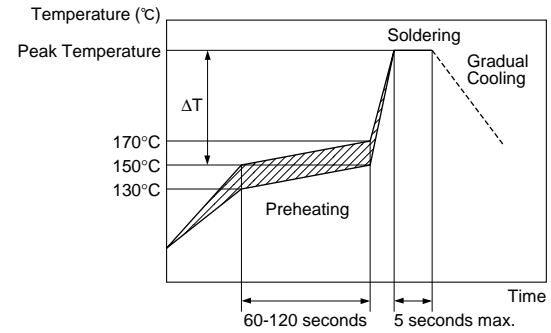

[Allowable Soldering Temperature and Time]

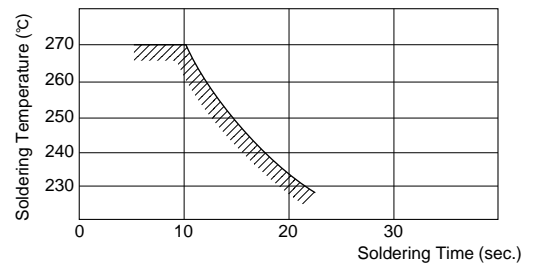

In case of repeated soldering, the accumulated soldering time must be within the range shown above.

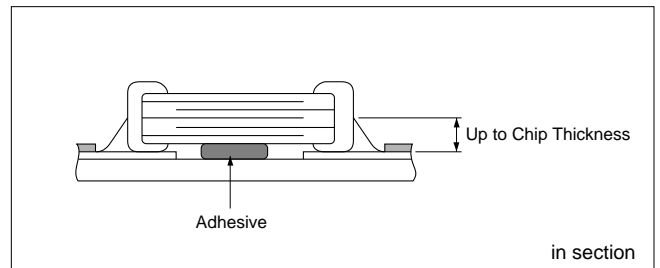

Continued on the following page. ↗

## ⚠ Caution

☒ Continued from the preceding page.

### 6. Correction with a Soldering Iron

- When sudden heat is applied to the components by use of a soldering iron, the mechanical strength of the components will go down because the extreme temperature change causes deformations inside the components.

In order to prevent mechanical damage to the components, preheating is required for both the components and the PCB board.

Preheating conditions, (The "Temperature of the Soldering Iron tip", "Preheating Temperature", "Temperature Differential" between iron tip and the

components and the PCB), should be within the conditions of table 3.

It is required to keep the temperature differential between the soldering Iron and the components surface ( $\Delta T$ ) as small as possible.

After soldering, do not allow the component/PCB to cool down rapidly.

The operating time for the re-working should be as short as possible. When re-working time is too long, it may cause solder leaching, and that will cause a reduction of the adhesive strength of the terminations.

Table 3

Part Number	Temperature of Soldering Iron tip	Preheating Temperature	Temperature Differential ( $\Delta T$ )	Atmosphere
G□□21/31	350°C max.	150°C min.	$\Delta T \leq 190^\circ\text{C}$	air
G□□32/43/55	280°C max.	150°C min.	$\Delta T \leq 130^\circ\text{C}$	air

\*Applicable for both Pb-Sn and Lead Free Solder.

Pb-Sn Solder: Sn-37Pb

Lead Free Solder: Sn-3.0Ag-0.5Cu

- Optimum Solder Amount when re-working Using a Soldering Iron

In case of larger sizes than G□□21, the top of the solder fillet should be lower than 2/3's of the thickness of the component.

If the solder amount is excessive, the risk of cracking is higher during board bending or under any other stressful conditions.

A Soldering iron  $\phi 3\text{mm}$  or smaller should be used.

It is also necessary to keep the soldering iron from touching the components during the re-work.

Solder wire with  $\phi 0.5\text{mm}$  or smaller is required for soldering.

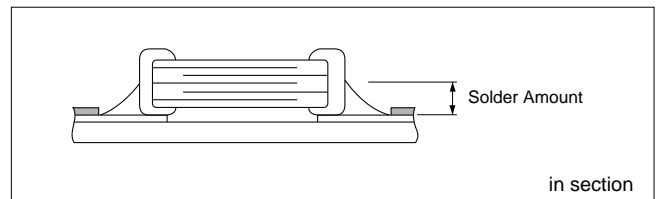

### 7. Washing

Excessive output of ultrasonic oscillation during cleaning causes PCBs to resonate, resulting in cracked chips or broken solder. Take note not to vibrate PCBs.

FAILURE TO FOLLOW THE ABOVE CAUTIONS MAY RESULT, WORST CASE, IN A SHORT CIRCUIT AND FUMING WHEN THE PRODUCT IS USED.

**Notice**

**■ Notice (Soldering and Mounting)**

**1. Construction of Board Pattern**

After installing chips, if solder is excessively applied to the circuit board, mechanical stress will cause destruction resistance characteristics to lower. To prevent this, be extremely careful in determining shape and dimension before designing the circuit board diagram.

**Construction and Dimensions of Pattern (Example)**

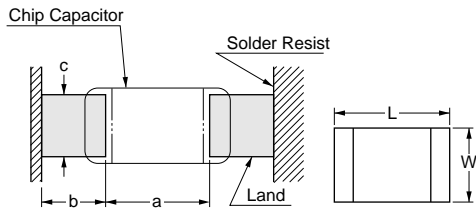

**Flow Soldering**

L×W	a	b	c
2.0×1.25	1.0-1.2	0.9-1.0	0.8-1.1
3.2×1.6	2.2-2.6	1.0-1.1	1.0-1.4

Flow soldering : 3.2×1.6 or less available.

**Reflow Soldering**

L×W	a	b	c
2.0×1.25	1.0-1.2	0.6-0.7	0.8-1.1
3.2×1.6	2.2-2.4	0.8-0.9	1.0-1.4
3.2×2.5	2.0-2.4	1.0-1.2	1.8-2.3
4.5×3.2	2.8-3.4	1.2-1.4	2.3-3.0
5.7×5.0	4.0-4.6	1.4-1.6	3.5-4.8

(in mm)

**Dimensions of Slit (Example)**

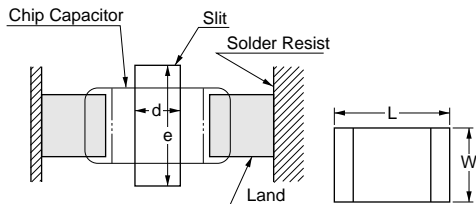

L×W	d	e
2.0×1.25	-	-
3.2×1.6	1.0-2.0	3.2-3.7
3.2×2.5	1.0-2.0	4.1-4.6

(in mm)

Preparing slit helps flux cleaning and resin coating on the back of the capacitor. But, the length of slit design should be shorter enough as much as possible to prevent the mechanical damage in the capacitor. The longer slit design might receive more severe mechanical stress from the PCB. Recommendable slit design is shown in the Table.

**Land Layout to Prevent Excessive Solder**

	Mounting Close to a Chassis	Mounting with Leaded Components	Mounting Leaded Components Later
Examples of Prohibition			
Examples of Improvements by the Land Division			

Continued on the following page. ↗

## Notice

☐ Continued from the preceding page.

### 2. Mounting of Chips

#### ● Thickness of adhesives applied

Keep thickness of adhesives applied (50-105 $\mu$ m or more) to reinforce the adhesive contact considering the thickness of the termination or capacitor (20-70 $\mu$ m) and the land pattern (30-35 $\mu$ m).

#### ● Mechanical shock of the chip placer

When the positioning claws and pick-up nozzle are worn, the load is applied to the chip while positioning is concentrated in one position, thus causing cracks, breakage, faulty positioning accuracy, etc.

Careful checking and maintenance are necessary to prevent unexpected trouble.

An excessively low bottom dead point of the suction nozzle imposes great force on the chip during mounting, causing cracked chips. Please set the suction nozzle's bottom dead point on the upper surface of the board.

### 3. Soldering

(1) Limit of losing effective area of the terminations and conditions needed for soldering.

Depending on the conditions of the soldering temperature and/or immersion (melting time), effective areas may be lost in some part of the terminations.

To prevent this, be careful in soldering so that any possible loss of the effective area on the terminations will securely remain at a maximum of 25% on all edge length A-B-C-D-A of part with A, B, C, D, shown in the Figure below.

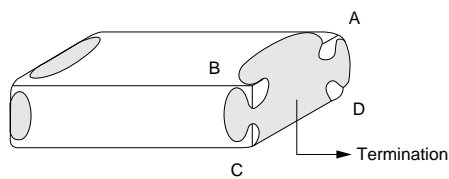

(2) Flux Application

● An excessive amount of flux generates a large quantity of flux gas, causing deteriorated solderability.

So apply flux thinly and evenly throughout.

(A foaming system is generally used for flow soldering.)

● Flux containing too high percentage of halide may cause corrosion of the outer electrodes unless sufficient cleaning. Use flux with a halide content of 0.2% max.

● Do not use strong acidic flux.

● Do not use water-soluble flux\*.

(\*Water-soluble flux can be defined as non rosin type flux including wash-type flux and non-wash-type flux.)

(3) Solder

The use of Sn-Zn based solder will deteriorate the reliability of the MLCC.

Please contact our sales representative or product engineers on the use of Sn-Zn based solder in advance.

Continued on the following page. ☐



## Notice

☒ Continued from the preceding page.

### 4. Cleaning

Please confirm there is no problem in the reliability of the product beforehand when cleaning it with the intended equipment.

The residue after cleaning it might cause the decrease in the surface resistance of the chip and the corrosion of the electrode part, etc. As a result it might cause reliability to deteriorate. Please confirm beforehand that there is no problem with the intended equipment in ultrasonic cleansing.

### 5. Resin Coating

Please use it after confirming there is no influence on the product with a intended equipment beforehand when the resin coating and molding.

A cracked chip might be caused at the cooling/heating cycle by the amount of resin spreading and/or bias thickness.

The resin for coating and molding must be selected as the stress is small when stiffening and the hygroscopic is low as possible.

## ■ Rating

### 1. Capacitance change of capacitor

#### (1) In case of X7R char.

Capacitors have an aging characteristic, whereby the capacitor continually decreases its capacitance slightly if the capacitor is left on for a long time. Moreover, capacitance might change greatly depending on the surrounding temperature or an applied voltage. So, it is not likely to be suitable for use in a time constant circuit.

Please contact us if you need detailed information.

#### (2) In case of U2J char.

Capacitance might change a little depending on the surrounding temperature or an applied voltage.

Please contact us if you intend to use this product in a strict time constant circuit.

### 2. Performance check by equipment

Before using a capacitor, check that there is no problem in the equipment's performance and the specifications.

Moreover, check the surge-proof ability of a capacitor in the equipment, if needed, because the surge voltage may exceed specific value by the inductance of the circuit.

**△Note:**

**1. Export Control**

<For customers outside Japan>

No Murata products should be used or sold, through any channels, for use in the design, development, production, utilization, maintenance or operation of, or otherwise contribution to (1) any weapons (Weapons of Mass Destruction [nuclear, chemical or biological weapons or missiles] or conventional weapons) or (2) goods or systems specially designed or intended for military end-use or utilization by military end-users.

<For customers in Japan>

For products which are controlled items subject to the "Foreign Exchange and Foreign Trade Law" of Japan, the export license specified by the law is required for export.

**2. Please contact our sales representatives or product engineers before using the products in this catalog for the applications listed below, which require especially high reliability for the prevention of defects which might directly damage a third party's life, body or property, or when one of our products is intended for use in applications other than those specified in this catalog.**

- |                             |                                                                                                      |
|-----------------------------|------------------------------------------------------------------------------------------------------|
| ① Aircraft equipment        | ② Aerospace equipment                                                                                |
| ③ Undersea equipment        | ④ Power plant equipment                                                                              |
| ⑤ Medical equipment         | ⑥ Transportation equipment (vehicles, trains, ships, etc.)                                           |
| ⑦ Traffic signal equipment  | ⑧ Disaster prevention / crime prevention equipment                                                   |
| ⑨ Data-processing equipment | ⑩ Application of similar complexity and/or reliability requirements to the applications listed above |

**3. Product specifications in this catalog are as of March 2010. They are subject to change or our products in it may be discontinued without advance notice. Please check with our sales representatives or product engineers before ordering. If there are any questions, please contact our sales representatives or product engineers.**

**4. Please read rating and △ CAUTION (for storage, operating, rating, soldering, mounting and handling) in this catalog to prevent smoking and/or burning, etc.**

**5. This catalog has only typical specifications because there is no space for detailed specifications. Therefore, please approve our product specifications or transact the approval sheet for product specifications before ordering.**

**6. Please note that unless otherwise specified, we shall assume no responsibility whatsoever for any conflict or dispute that may occur in connection with the effect of our and/or a third party's intellectual property rights and other related rights in consideration of your use of our products and/or information described or contained in our catalogs. In this connection, no representation shall be made to the effect that any third parties are authorized to use the rights mentioned above under licenses without our consent.**

**7. No ozone depleting substances (ODS) under the Montreal Protocol are used in our manufacturing process.**



<http://www.murata.com/>

**Head Office**

1-10-1, Higashi Kotari, Nagaokakyo-shi, Kyoto 617-8555, Japan  
Phone: 81-75-951-9111

**International Division**

3-29-12, Shibuya, Shibuya-ku, Tokyo 150-0002, Japan  
Phone: 81-3-5469-6123 Fax: 81-3-5469-6155 E-mail: intl@murata.co.jp