

## P6KE-G Series

**Breakdown Voltage: 6.8 to 600 Volts**

**Peak Pulse Power: 600 Watts**

**RoHS Device**



### Features

- Glass passivated chip.
- 600W peak pulse power capability with a 10/1000 $\mu$ s waveform, repetitive rate (duty cycle):0.01%
- Low leakage.
- Uni and Bidirectional unit.
- Excellent clamping capability.
- Very fast response time.
- UL recognized file # E349157  Range: P6KE6.8(C)A thru. P6KE47(C)A

### Mechanical Data

- Case: Molded plastic DO-15.
- Epoxy: UL 94V-0 rate flame retardant.
- Lead: Solderable per MIL-STD-202, method 208 guranteed.
- Polarity: Color band denotes cathode end except Bipolar.
- Monuting position: Any.
- Weight: 0.402 gram (approx.)

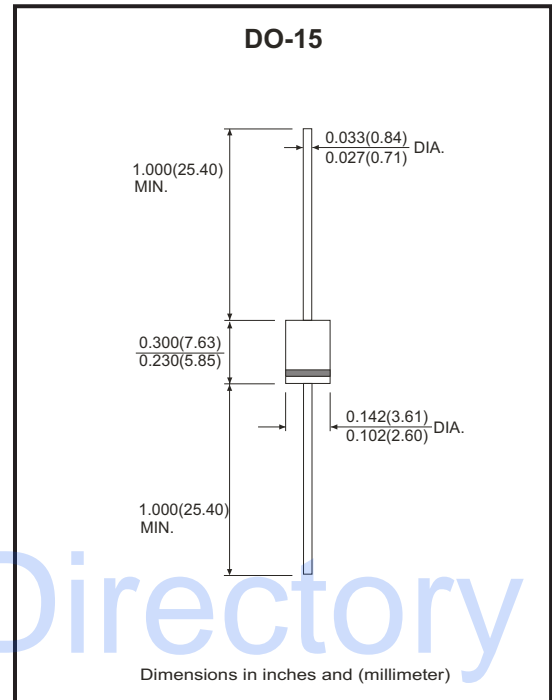

### Maximum Ratings (TA=25°C unless otherwise noted)

| Parameter  | Symbol                            | Value          | Unit |
|--|-----------------------------------|----------------|------|
| Peak power dissipation with a 10/1000 $\mu$ s waveform (Note 1)                      | PPP                               | 600            | W    |
| Peak pulse current with a 10/1000 $\mu$ s waveform (Note 1)                          | I <sub>PP</sub>                   | See Next Table | A    |
| Power dissipation on infinite heatsink at T <sub>L</sub> =75°C                       | P <sub>D</sub>                    | 5.0            | W    |
| Peak forward surge current, 8.3ms single half sine-wave unidirectional only (Note 2) | I <sub>FSM</sub>                  | 100            | A    |
| Maximum instantaneous forward voltage at 50 A for unidirectional only (Note 3)       | V <sub>F</sub>                    | 3.5/5.0        | V    |
| Operating junction and storage temperature range                                     | T <sub>J</sub> , T <sub>STG</sub> | -55 to +150    | °C   |

NTOES:

- (1) Non-repetitive current pulse per fig.5 and derated above TA=25°C per fig.1
- (2) Measured on 8.3ms single half sine-wave or equivalent square wave, duty cycle=4 pulses per minute maximum
- (3) V<sub>F</sub><3.5V for devices of V<sub>BR</sub><200V and V<sub>F</sub><5.0V for devices of V<sub>BR</sub>>201V

Company reserves the right to improve product design , functions and reliability without notice.

REV:E

## Rating and Characteristic Curves (P6KE-G Series)

Fig.1 - Pulse Derating Curve

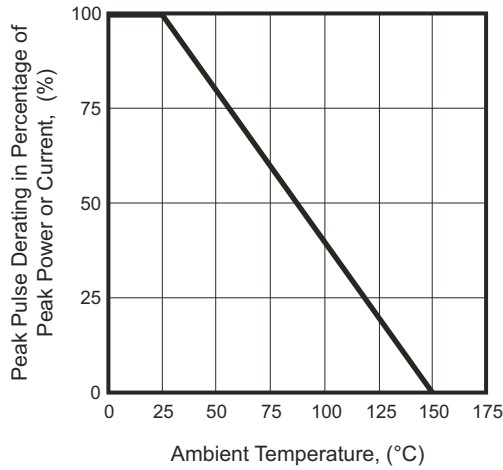

Fig.2 - Maximum Non-Repetitive Surge Current



Fig.3 - Steady State Power Derating Curve

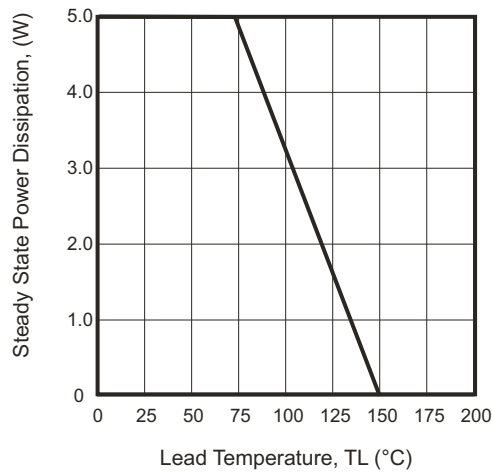

Fig.4 - Peak Pulse Power Rating Curve



Fig.5 - Pulse Waveform

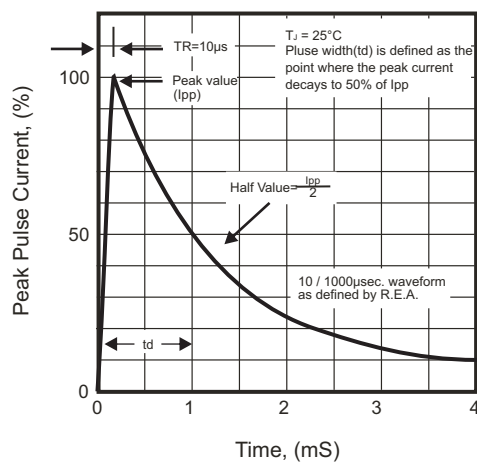
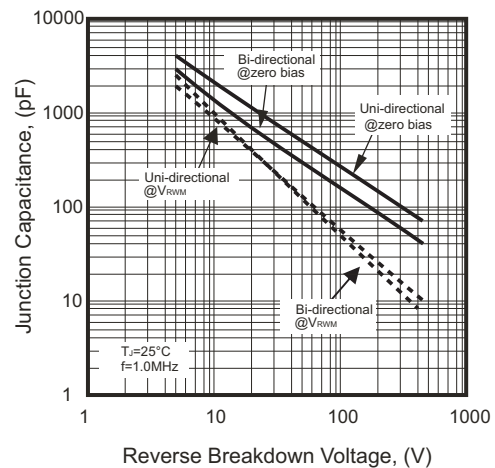

Fig.6 - Typical Junction Capacitance



Company reserves the right to improve product design, functions and reliability without notice.

REV:E

# 600W Transient Voltage Suppressor

## Electrical Characteristics (P6KE-G Series)

| Part No.      | Breakdown voltage<br>VBR @ IT |          |         | Maximum Reverse Leakage<br>@VRWM<br>IR (uA) | Working Peak Reverse Voltage<br>VRWM (V) | Maximum Reverse Surge Current<br>IPP (A) | Maximum Clamping Voltage<br>@IPP<br>Vc (V) | Marking Code |           |
|---------------|-------------------------------|----------|---------|---|--|--|--|--------------|-----------|
|               | Min. (V)                      | Max. (V) | IT (mA) |   |  |  |  | UNI          | BI        |
| P6KE6.8(C)A-G | 6.46                          | 7.14     | 10      | 1000  | 5.8                                      | 57.14                                    | 10.5                                       | P6KE6.8A     | P6KE6.8CA |
| P6KE7.5(C)A-G | 7.13                          | 7.88     | 10      | 500   | 6.4                                      | 53.10                                    | 11.3                                       | P6KE7.5A     | P6KE7.5CA |
| P6KE8.2(C)A-G | 7.79                          | 8.61     | 10      | 200   | 7.0                                      | 49.59                                    | 12.1                                       | P6KE8.2A     | P6KE8.2CA |
| P6KE9.1(C)A-G | 8.65                          | 9.56     | 1       | 50  | 7.8                                      | 44.78                                    | 13.4                                       | P6KE9.1A     | P6KE9.1CA |
| P6KE10(C)A-G  | 9.50                          | 10.50    | 1       | 10  | 8.6                                      | 41.38                                    | 14.5                                       | P6KE10A      | P6KE10CA  |
| P6KE11(C)A-G  | 10.45                         | 11.55    | 1       | 5.0   | 9.4                                      | 38.46                                    | 15.6                                       | P6KE11A      | P6KE11CA  |
| P6KE12(C)A-G  | 11.40                         | 12.60    | 1       | 5.0   | 10.2                                     | 35.93                                    | 16.7                                       | P6KE12A      | P6KE12CA  |
| P6KE13(C)A-G  | 12.35                         | 13.65    | 1       | 1   | 11.1                                     | 32.97                                    | 18.2                                       | P6KE13A      | P6KE13CA  |
| P6KE15(C)A-G  | 14.25                         | 15.75    | 1       | 1   | 12.8                                     | 28.30                                    | 21.2                                       | P6KE15A      | P6KE15CA  |
| P6KE16(C)A-G  | 15.20                         | 16.80    | 1       | 1   | 13.6                                     | 26.67                                    | 22.5                                       | P6KE16A      | P6KE16CA  |
| P6KE18(C)A-G  | 17.10                         | 18.90    | 1       | 1   | 15.3                                     | 23.81                                    | 25.2                                       | P6KE18A      | P6KE18CA  |
| P6KE20(C)A-G  | 19.00                         | 21.00    | 1       | 1   | 17.1                                     | 21.66                                    | 27.7                                       | P6KE20A      | P6KE20CA  |
| P6KE22(C)A-G  | 20.90                         | 23.10    | 1       | 1   | 18.8                                     | 19.61                                    | 30.6                                       | P6KE22A      | P6KE22CA  |
| P6KE24(C)A-G  | 22.80                         | 25.20    | 1       | 1   | 20.5                                     | 18.07                                    | 33.2                                       | P6KE24A      | P6KE24CA  |
| P6KE27(C)A-G  | 25.65                         | 28.35    | 1       | 1   | 23.1                                     | 16.00                                    | 37.5                                       | P6KE27A      | P6KE27CA  |
| P6KE30(C)A-G  | 28.50                         | 31.50    | 1       | 1   | 25.6                                     | 14.49                                    | 41.4                                       | P6KE30A      | P6KE30CA  |
| P6KE33(C)A-G  | 31.35                         | 34.65    | 1       | 1   | 28.2                                     | 13.13                                    | 45.7                                       | P6KE33A      | P6KE33CA  |
| P6KE36(C)A-G  | 34.20                         | 37.80    | 1       | 1   | 30.8                                     | 12.02                                    | 49.9                                       | P6KE36A      | P6KE36CA  |
| P6KE39(C)A-G  | 37.05                         | 40.95    | 1       | 1   | 33.3                                     | 11.13                                    | 53.9                                       | P6KE39A      | P6KE39CA  |
| P6KE43(C)A-G  | 40.85                         | 45.15    | 1       | 1   | 36.8                                     | 10.12                                    | 59.3                                       | P6KE43A      | P6KE43CA  |
| P6KE47(C)A-G  | 44.65                         | 49.35    | 1       | 1   | 40.2                                     | 9.26                                     | 64.8                                       | P6KE47A      | P6KE47CA  |
| P6KE51(C)A-G  | 48.45                         | 53.55    | 1       | 1   | 43.6                                     | 8.56                                     | 70.1                                       | P6KE51A      | P6KE51CA  |
| P6KE56(C)A-G  | 53.20                         | 58.80    | 1       | 1   | 47.8                                     | 7.79                                     | 77.0                                       | P6KE56A      | P6KE56CA  |
| P6KE62(C)A-G  | 58.90                         | 65.10    | 1       | 1   | 53.0                                     | 7.06                                     | 85.0                                       | P6KE62A      | P6KE62CA  |
| P6KE68(C)A-G  | 64.60                         | 71.40    | 1       | 1   | 58.1                                     | 6.52                                     | 92.0                                       | P6KE68A      | P6KE68CA  |
| P6KE75(C)A-G  | 71.25                         | 78.75    | 1       | 1   | 64.1                                     | 5.83                                     | 103.0                                      | P6KE75A      | P6KE75CA  |
| P6KE82(C)A-G  | 77.90                         | 86.10    | 1       | 1   | 70.1                                     | 5.31                                     | 113.0                                      | P6KE82A      | P6KE82CA  |
| P6KE91(C)A-G  | 86.45                         | 95.55    | 1       | 1   | 77.8                                     | 4.80                                     | 125.0                                      | P6KE91A      | P6KE91CA  |
| P6KE100(C)A-G | 95.00                         | 105.00   | 1       | 1   | 85.5                                     | 4.38                                     | 137.0                                      | P6KE100A     | P6KE100CA |
| P6KE110(C)A-G | 104.50                        | 115.50   | 1       | 1   | 94.0                                     | 3.95                                     | 152.0                                      | P6KE110A     | P6KE110CA |
| P6KE120(C)A-G | 114.00                        | 126.00   | 1       | 1   | 102.0                                    | 3.64                                     | 165.0                                      | P6KE120A     | P6KE120CA |
| P6KE130(C)A-G | 123.50                        | 136.50   | 1       | 1   | 111.0                                    | 3.35                                     | 179.0                                      | P6KE130A     | P6KE130CA |
| P6KE150(C)A-G | 142.50                        | 157.50   | 1       | 1   | 128.0                                    | 2.90                                     | 207.0                                      | P6KE150A     | P6KE150CA |
| P6KE160(C)A-G | 152.00                        | 168.00   | 1       | 1   | 136.0                                    | 2.74                                     | 219.0                                      | P6KE160A     | P6KE160CA |
| P6KE170(C)A-G | 161.50                        | 178.50   | 1       | 1   | 145.0                                    | 2.56                                     | 234.0                                      | P6KE170A     | P6KE170CA |
| P6KE180(C)A-G | 171.00                        | 189.00   | 1       | 1   | 154.0                                    | 2.44                                     | 246.0                                      | P6KE180A     | P6KE180CA |
| P6KE200(C)A-G | 190.00                        | 210.00   | 1       | 1   | 171.0                                    | 2.19                                     | 274.0                                      | P6KE200A     | P6KE200CA |
| P6KE220(C)A-G | 209.00                        | 231.00   | 1       | 1   | 185.0                                    | 1.83                                     | 328.0                                      | P6KE220A     | P6KE220CA |
| P6KE250(C)A-G | 237.50                        | 262.50   | 1       | 1   | 214.0                                    | 1.74                                     | 344.0                                      | P6KE250A     | P6KE250CA |
| P6KE300(C)A-G | 285.00                        | 315.00   | 1       | 1   | 256.0                                    | 1.45                                     | 414.0                                      | P6KE300A     | P6KE300CA |
| P6KE350(C)A-G | 332.50                        | 367.50   | 1       | 1   | 299.3                                    | 1.24                                     | 482.0                                      | P6KE350A     | P6KE350CA |
| P6KE380(C)A-G | 361.00                        | 399.00   | 1       | 1   | 324.9                                    | 1.14                                     | 524.4                                      | P6KE380A     | P6KE380CA |
| P6KE400(C)A-G | 380.00                        | 420.00   | 1       | 1   | 342.0                                    | 1.09                                     | 548.0                                      | P6KE400A     | P6KE400CA |
| P6KE440(C)A-G | 418.00                        | 462.00   | 1       | 1   | 376.2                                    | 0.99                                     | 607.2                                      | P6KE440A     | P6KE440CA |
| P6KE500(C)A-G | 475.00                        | 525.00   | 1       | 1   | 427.5                                    | 0.87                                     | 690.0                                      | P6KE500A     | P6KE500CA |
| P6KE520(C)A-G | 494.00                        | 546.00   | 1       | 1   | 444.6                                    | 0.84                                     | 717.6                                      | P6KE520A     | P6KE520CA |
| P6KE550(C)A-G | 522.50                        | 577.50   | 1       | 1   | 470.3                                    | 0.79                                     | 759.0                                      | P6KE550A     | P6KE550CA |
| P6KE600(C)A-G | 570.00                        | 630.00   | 1       | 1   | 513.0                                    | 0.72                                     | 828.0                                      | P6KE600A     | P6KE600CA |

- Note: 1) Suffix A denotes 5% tolerance devices.  
 2) Add suffix "C" or "CA" after part number to specify Bi-directional devices.  
 3) For Bi-Directional devices having VR of 10 volts and under, the IR limit is double.

Company reserves the right to improve product design , functions and reliability without notice.

REV:E

## Taping Specification For Axial Lead Diodes

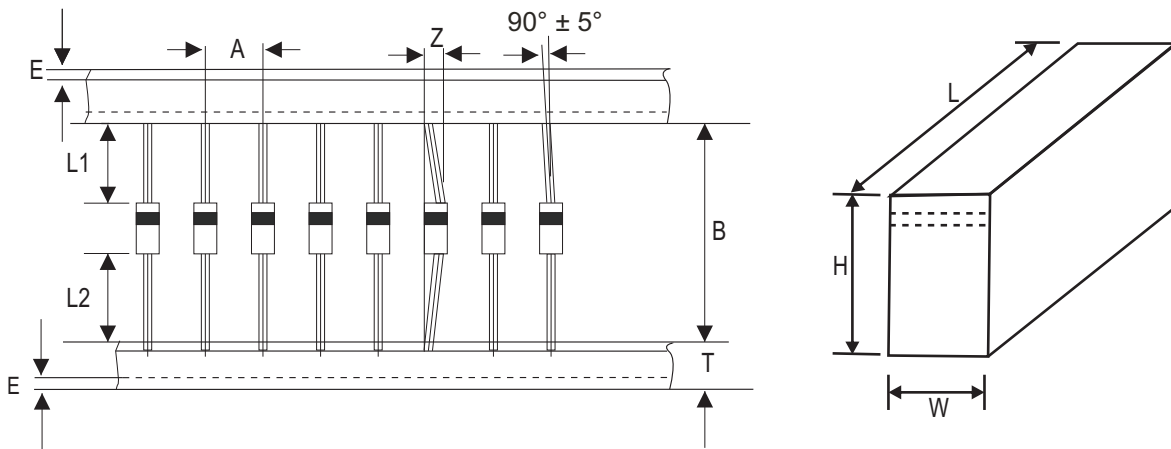

| DO-15 | SYMBOL | A             | B             | Z           | T             | E           |
|-------|--------|---------------|---------------|-------------|---------------|-------------|
|       | (mm)   | 5.00 ± 0.50   | 52.00 ± 0.50  | 1.20 (max)  | 6.00 ± 0.40   | 3.00 (max)  |
|       | (inch) | 0.197 ± 0.020 | 2.047 ± 0.020 | 0.047 (max) | 0.236 ± 0.016 | 0.118 (max) |

| DO-15 | SYMBOL | L1          | L2          | L      | W     | H      |
|-------|--------|-------------|-------------|--------|-------|--------|
|       | (mm)   | 1.00 (max)  | 1.00 (max)  | 260.00 | 75.00 | 145.00 |
|       | (inch) | 0.039 (max) | 0.039 (max) | 10.236 | 2.953 | 5.709  |

## Standard Packaging

| Case Type | AMMO PACK      |                   |
|-----------|----------------|-------------------|
|           | BOX<br>( pcs ) | CARTON<br>( pcs ) |
| DO-15     | 3,000          | 30,000            |

# Mouser Electronics

Authorized Distributor

Click to View Pricing, Inventory, Delivery & Lifecycle Information:

## Comchip Technology:

[P6KE150A-G](#) [P6KE15A-G](#) [P6KE15CA-G](#) [P6KE160A-G](#) [P6KE170A-G](#) [P6KE180A-G](#) [P6KE18CA-G](#) [P6KE200A-G](#)  
[P6KE20CA-G](#) [P6KE220A-G](#) [P6KE22A-G](#) [P6KE22CA-G](#) [P6KE24A-G](#) [P6KE250A-G](#) [P6KE250-G](#) [P6KE27A-G](#)  
[P6KE27CA-G](#) [P6KE300A-G](#) [P6KE300-G](#) [P6KE30A-G](#) [P6KE30CA-G](#) [P6KE33A-G](#) [P6KE33CA-G](#) [P6KE350A-G](#)  
[P6KE350-G](#) [P6KE380-HF](#) [P6KE400A-G](#) [P6KE400-G](#) [P6KE43A-G](#) [P6KE47A-G](#) [P6KE47CA-G](#) [P6KE51A-G](#)  
[P6KE51CA-G](#) [P6KE56CA-G](#) [P6KE6.8A-G](#) [P6KE6.8CA-G](#) [P6KE6.8-G](#) [P6KE62A-G](#) [P6KE62CA-G](#) [P6KE75CA-G](#)  
[P6KE400C-G](#) [P6KE600C-G](#) [P6KE220CA-G](#) [P6KE520C-G](#) [P6KE550-G](#) [P6KE380C-G](#) [P6KE600A-G](#) [P6KE29A-G](#)  
[P6KE350C-G](#) [P6KE440-G](#) [P6KE550A-G](#) [P6KE500-G](#) [P6KE500CA-G](#) [P6KE380-G](#) [P6KE500A-G](#) [P6KE250C-G](#)  
[P6KE440A-G](#) [P6KE300C-G](#) [P6KE380CA-G](#) [P6KE550C-G](#) [P6KE520CA-G](#) [P6KE200CA-G](#) [P6KE520A-G](#) [P6KE34A-](#)  
[G](#) [P6KE380A-G](#) [P6KE440CA-G](#) [P6KE440C-G](#) [P6KE550CA-G](#) [P6KE600-G](#) [P6KE400CA-G](#) [P6KE300CA-G](#)  
[P6KE250CA-G](#) [P6KE350CA-G](#) [P6KE600CA-G](#) [P6KE500C-G](#) [P6KE520-G](#)