

Features

- Glass Passivated Die Construction
- Super-Fast Recovery Time For High Efficiency
- Low Forward Voltage Drop and High Current Capability
- Surge Overload Rating to 35A Peak
- **Lead Free Finish, RoHS Compliant (Note 3)**

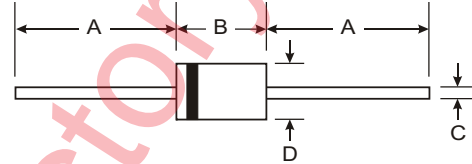

Mechanical Data

- Case: DO-41
- Case Material: Molded Plastic. UL Flammability Classification Rating 94V-0
- Moisture Sensitivity: Level 1 per J-STD-020C
- Terminals: Finish - Bright Tin. Solderable per MIL-STD-202, Method 208
- Polarity: Cathode Band
- Ordering Information: See Last Page
- Marking: R120
- Weight: 0.34 grams (approximate)

DO-41 Plastic		
Dim	Min	Max
A	25.40	—
B	4.06	5.21
C	0.71	0.864
D	2.00	2.72
All Dimensions in mm		

Maximum Ratings and Electrical Characteristics

@ T_A = 25°C unless otherwise specified

Single phase, half wave, 60Hz, resistive or inductive load.
For capacitive load, derate current by 20%.

Characteristic	Symbol	Value	Unit
Peak Repetitive Reverse Voltage	V _{RRM}	200	V
Working Peak Reverse Voltage	V _{RWM}		
DC Blocking Voltage	V _R		
RMS Reverse Voltage	V _{R(RMS)}	140	V
Average Rectified Output Current @ T _L = 130°C	I _o	1.0	A
Non-Repetitive Peak Forward Surge Current 8.3ms Single half sine-wave Superimposed on Rated Load (JEDEC Method)	I _{FSM}	35	A
Forward Voltage @ I _F = 1.0A, T _J = 25°C @ I _F = 1.0A, T _J = 150°C	V _{FM}	0.875 0.710	V
Peak Reverse Current at Rated DC Blocking Voltage @ T _J = 25°C @ T _J = 150°C	I _{RM}	2.0 50	μA
Reverse Recovery Time (Note 2)	t _{rr}	25	ns
Typical Junction Capacitance (Note 1)	C _j	27	pF
Typical Thermal Resistance, Junction to Lead	R _{θJL}	50	K/W
Operating and Storage Temperature Range	T _j , T _{STG}	-55 to +150	°C

- Notes:
1. Measured at 1.0MHz and applied reverse voltage of 4V DC.
 2. Measured with I_F = 0.5A, I_R = 1.0A, I_{rr} = 0.25A. See Figure 6.
 3. RoHS revision 13.2.2003. Glass and High Temperature Solder Exemptions Applied, see EU Directive Annex Notes 5 and 7.

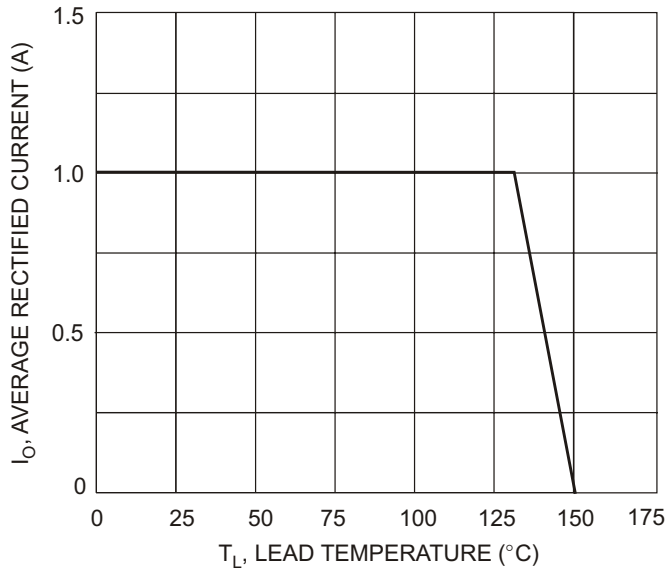

Fig. 1 Forward Current Derating Curve

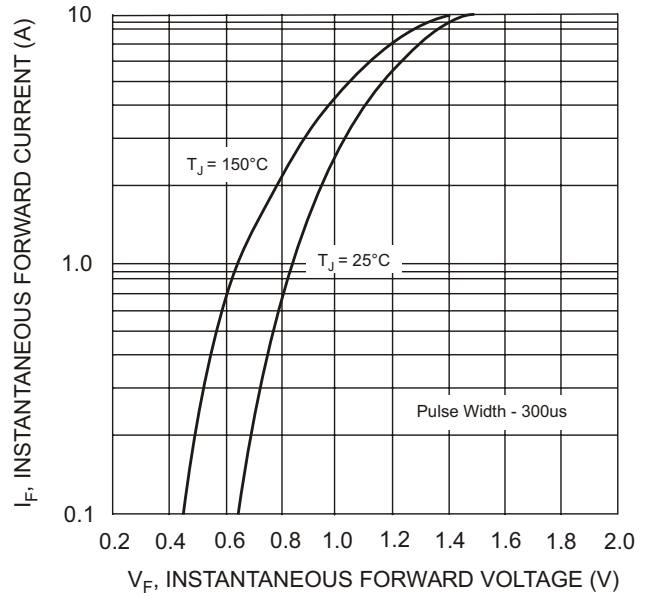

Fig. 2 Typical Forward Characteristics

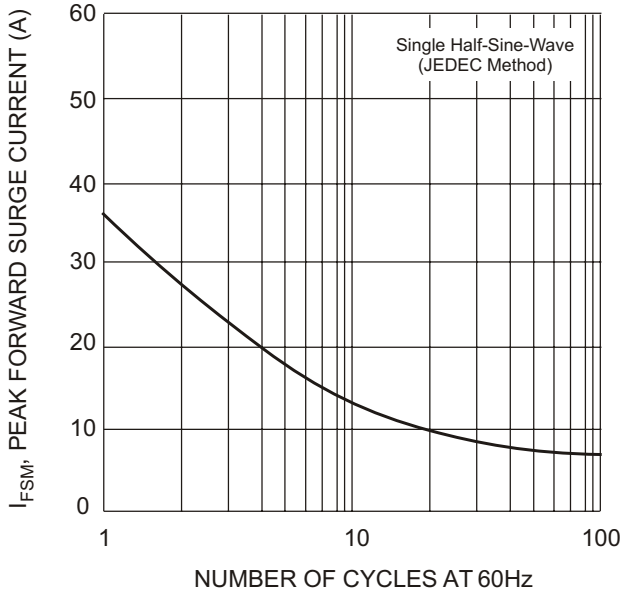

Fig. 3 Surge Current Derating Curve

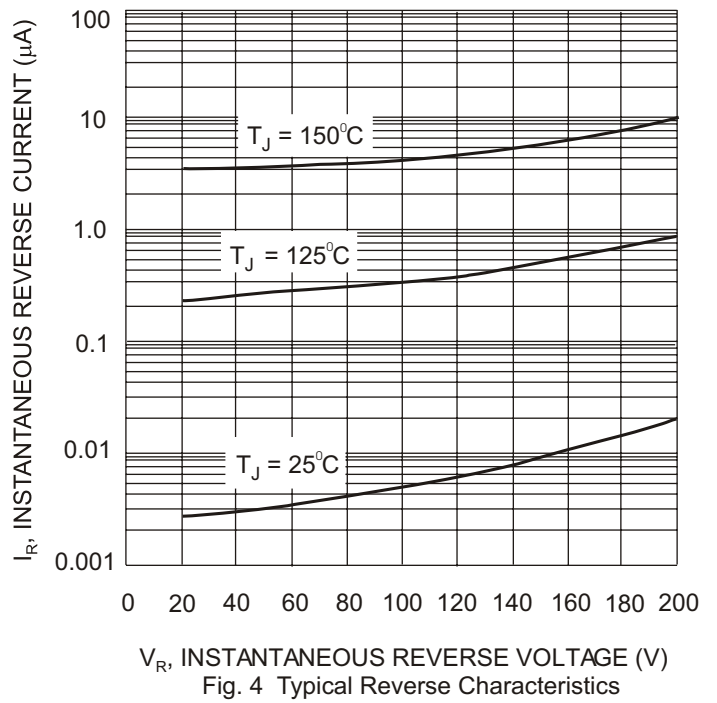

Fig. 4 Typical Reverse Characteristics

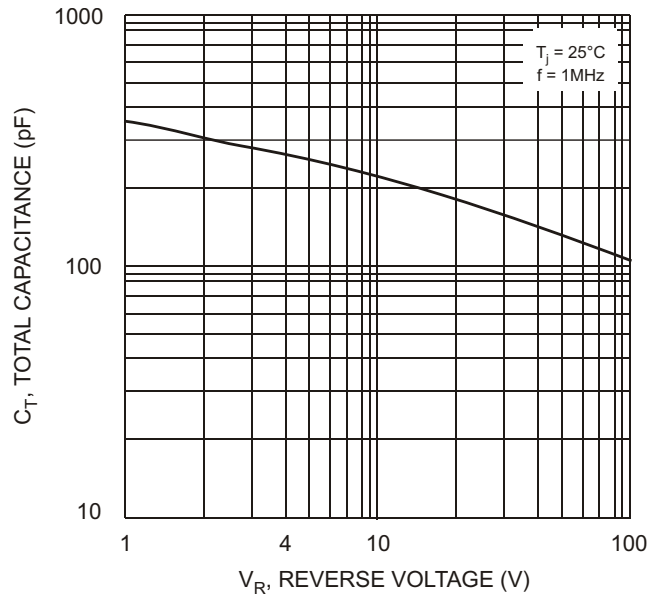

Fig. 5 Typical Total Capacitance

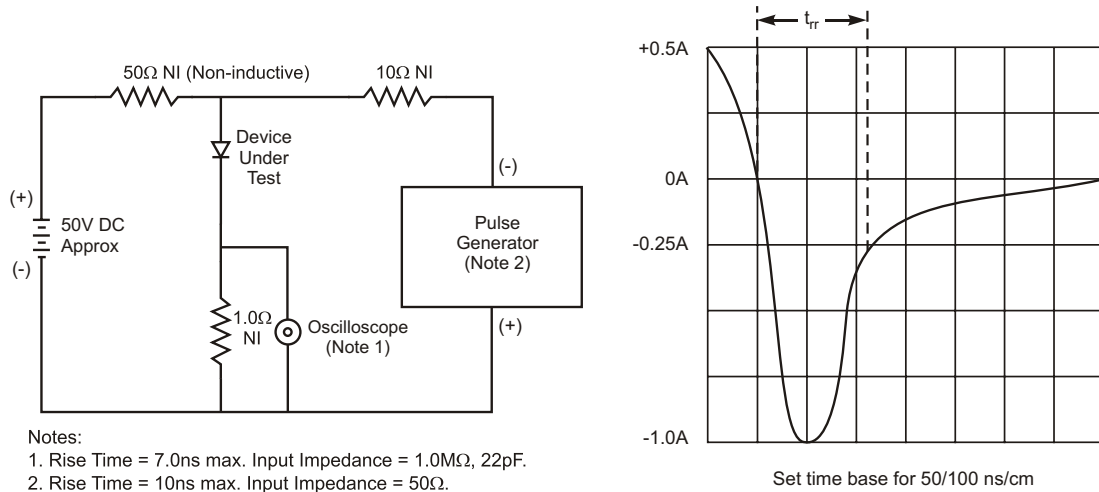

Fig. 6 Reverse Recovery Time Characteristic and Test Circuit

Ordering Information (Note 4)

Device	Packaging	Shipping
MUR120-A	DO-41	5K/Ammo Pack
MUR120-B	DO-41	1K/Bulk
MUR120-T	DO-41	5K/Tape & Reel, 13-inch

Notes: 4. For packaging details, visit our website at <http://www.diodes.com/datasheets/ap02008.pdf>