

# Low Current Seven Segment Displays

## Technical Data

HDSP-335X Series  
HDSP-555X Series  
HDSP-751X Series  
HDSP-A10X Series  
HDSP-A80X Series  
HDSP-A90X Series  
HDSP-E10X Series  
HDSP-F10X Series  
HDSP-G10X Series  
HDSP-H10X Series  
HDSP-K12X, K70X Series  
HDSP-N10X Series

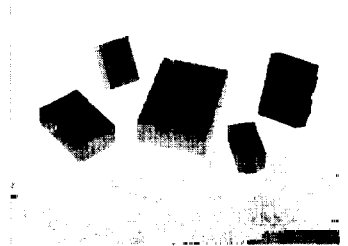
### Features

- **Low Power Consumption**
- **Industry Standard Size**
- **Industry Standard Pinout**
- **Choice of Character Size**  
7.6 mm (0.30 in), 10 mm (0.40 in), 10.9 mm (0.43 in), 14.2 mm (0.56 in), 20 mm (0.8 in)
- **Choice of Colors**  
AlGaAs Red, High Efficiency Red (HER), Yellow, Green
- **Excellent Appearance**  
Evenly Lighted Segments  
 $\pm 50^\circ$  Viewing Angle
- **Design Flexibility**  
Common Anode or Common Cathode  
Single and Dual Digit  
Left and Right Hand Decimal Points  
 $\pm 1$ . Overflow Character
- **Categorized for Luminous Intensity**  
Yellow and Green  
Categorized for Color  
Use of Like Categories Yields a Uniform Display
- **Excellent for Long Digit String Multiplexing**

### Description

These low current seven segment displays are designed for applications requiring low power consumption. They are tested and selected for their excellent low current characteristics to ensure that the segments are matched at low currents. Drive currents as low as 1 mA per segment are available.

Pin for pin equivalent displays are also available in a standard current or high light ambient design. The standard current displays are available in all colors and are ideal for most applications. The high light ambient displays are ideal for sunlight ambients or long string lengths. For additional information see the 7.6 mm Micro Bright Seven Segment Displays, 10 mm Seven Segment Displays, 7.6 mm/10.9 mm Seven Segment Displays, 14.2 mm Seven Segment Displays, 20 mm Seven Segment Displays, or High Light Ambient Seven Segment Displays data sheets.



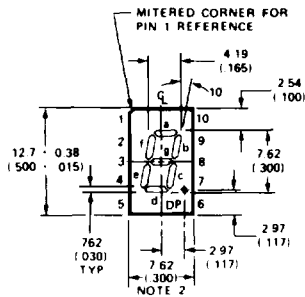
## Devices

AlGaAs HDSP-	HER HDSP-	Yellow HDSP-	Green HDSP-	Description	Package Drawing
A101	7511	A801	A901	7.6 mm Common Anode Right Hand Decimal	A
A103	7513	A803	A903	7.6 mm Common Cathode Right Hand Decimal	B
A107	7517	A807	A907	7.6 mm Common Anode $\pm 1$ . Overflow	C
A108	7518	A808	A908	7.6 mm Common Cathode $\pm 1$ . Overflow	D
F101				10 mm Common Anode Right Hand Decimal	E
F103				10 mm Common Cathode Right Hand Decimal	F
F107				10 mm Common Anode $\pm 1$ . Overflow	G
F108				10 mm Common Cathode $\pm 1$ . Overflow	H
G101				10 mm Two Digit Common Anode Right Hand Decimal	X
G103				10 mm Two Digit Common Cathode Right Hand Decimal	Y
E100	3350			10.9 mm Common Anode Left Hand Decimal	I
E101	3351			10.9 mm Common Anode Right Hand Decimal	J
E103	3353			10.9 mm Common Cathode Right Hand Decimal	K
E106	3356			10.9 mm Universal $\pm 1$ . Overflow <sup>(1)</sup>	L
H101	5551			14.2 mm Common Anode Right Hand Decimal	M
H103	5553			14.2 mm Common Cathode Right Hand Decimal	N
H107	5557			14.2 mm Common Anode $\pm 1$ . Overflow	O
H108	5558			14.2 mm Common Cathode $\pm 1$ . Overflow	P
K121	K701			14.2 mm Two Digit Common Anode Right Hand Decimal	R
K123	K703			14.2 mm Two Digit Common Cathode Right Hand Decimal	S
N100				20 mm Common Anode Left Hand Decimal	Q
N101				20 mm Common Anode Right Hand Decimal	T
N103				20 mm Common Cathode Right Hand Decimal	U
N105				20 mm Common Cathode Left Hand Decimal	V
N106				20 mm Universal $\pm 1$ . Overflow <sup>(1)</sup>	W

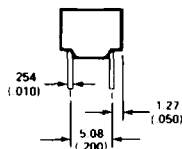
### Note:

1. Universal pinout brings the anode and cathode of each segment's LED out to separate pins. See internal diagrams L or W.

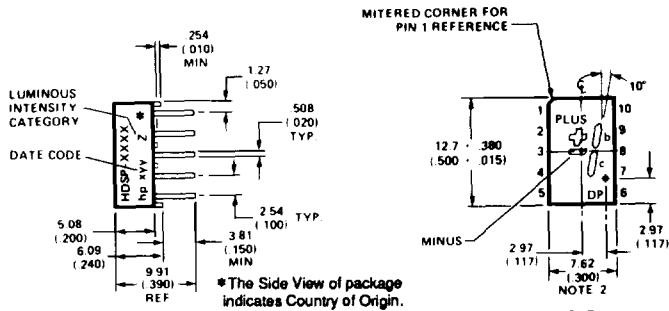
## Package Dimensions



A, B



A, B, C, D



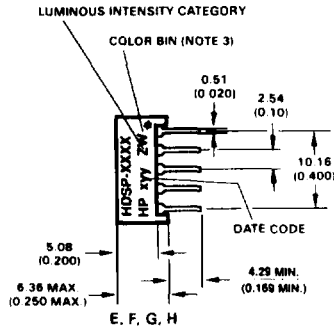
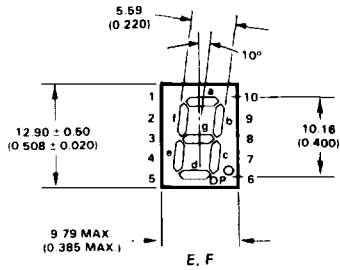
C, D

PIN	FUNCTION			
	A	B	C	D
1	ANODE 1 <sup>(4)</sup>	CATHODE 5 <sup>(5)</sup>	ANODE 4 <sup>(4)</sup>	CATHODE 5 <sup>(5)</sup>
2	CATHODE 1	ANODE 1	CATHODE PLUS	ANODE PLUS
3	CATHODE g	ANODE g	CATHODE MINUS	ANODE MINUS
4	CATHODE e	ANODE e	NC	NC
5	CATHODE d	ANODE d	NC	NC
6	ANODE 1 <sup>(4)</sup>	CATHODE 5 <sup>(5)</sup>	ANODE 4 <sup>(4)</sup>	CATHODE 5 <sup>(5)</sup>
7	CATHODE DP	ANODE DP	CATHODE DP	ANODE DP
8	CATHODE c	ANODE c	CATHODE c	ANODE c
9	CATHODE b	ANODE b	CATHODE b	ANODE b
10	CATHODE a	ANODE a	NC	NC

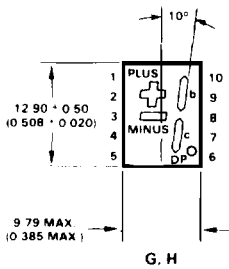
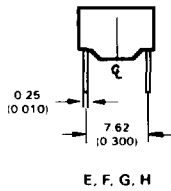
### NOTES:

1. ALL DIMENSIONS IN MILLIMETRES (INCHES).
2. MAXIMUM.
3. ALL UNTOLERANCED DIMENSIONS ARE FOR REFERENCE ONLY.
4. REDUNDANT ANODES.
5. REDUNDANT CATHODES.

## Package Dimensions (continued)



\* The Side View of package indicates Country of Origin.

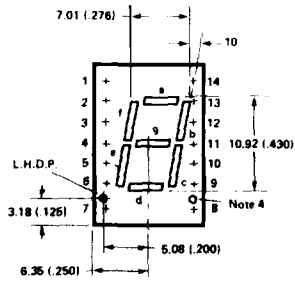


PIN	FUNCTION			
	E	F	G	H
1	ANODE <sup>(1)</sup>	CATHODE <sup>(2)</sup>	ANODE <sup>(1)</sup>	CATHODE <sup>(2)</sup>
2	CATHODE f	ANODE f	CATHODE PLUS	ANODE PLUS
3	CATHODE g	ANODE g	CATHODE MINUS	ANODE MINUS
4	CATHODE e	ANODE e	NC	NC
5	CATHODE d	ANODE d	NC	NC
6	ANODE <sup>(1)</sup>	CATHODE <sup>(2)</sup>	ANODE <sup>(1)</sup>	CATHODE <sup>(2)</sup>
7	CATHODE DP	ANODE DP	CATHODE DP	ANODE DP
8	CATHODE c	ANODE c	CATHODE c	ANODE c
9	CATHODE b	ANODE b	CATHODE b	ANODE b
10	CATHODE a	ANODE a	NC	NC

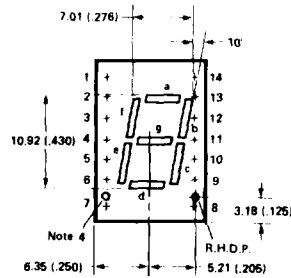
### NOTES:

1. ALL DIMENSIONS IN MILLIMETRES (INCHES).
2. ALL UNTOLERANCED DIMENSIONS ARE FOR REFERENCE ONLY.
3. FOR YELLOW AND GREEN SERIES PRODUCT ONLY.
4. REDUNDANT ANODES.
5. REDUNDANT CATHODES.

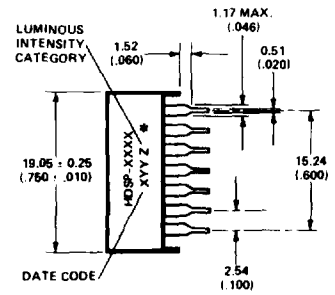
## Package Dimensions (continued)



I  
FRONT VIEW

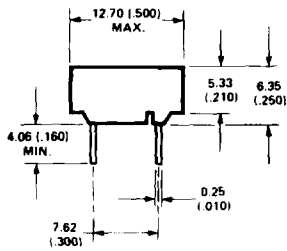


J, K  
FRONT VIEW

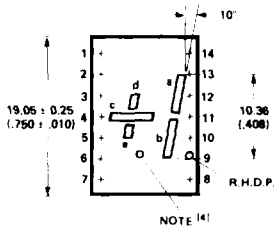


SIDE VIEW

\*The Side View of package indicates Country of Origin.



END VIEW



L

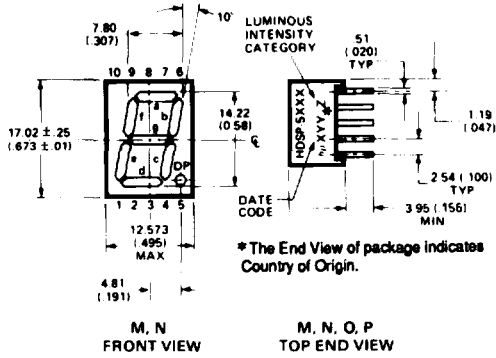
PIN	FUNCTION			
	I	J	K	L
1	CATHODE a	CATHODE a	ANODE a	CATHODE d
2	CATHODE f	CATHODE f	ANODE f	ANODE d
3	ANODE <sup>[3]</sup>	ANODE <sup>[3]</sup>	CATHODE <sup>[6]</sup>	NO PIN
4	NO PIN	NO PIN	NO PIN	CATHODE c
5	NO PIN	NO PIN	NO PIN	CATHODE e
6	CATHODE dp	NO CONN. <sup>[5]</sup>	NO CONN. <sup>[5]</sup>	ANODE e
7	CATHODE e	CATHODE e	ANODE e	ANODE c
8	CATHODE d	CATHODE d	ANODE d	ANODE dp
9	NO CONN. <sup>[5]</sup>	CATHODE dp	ANODE dp	CATHODE dp
10	CATHODE c	CATHODE c	ANODE c	CATHODE b
11	CATHODE g	CATHODE g	ANODE g	CATHODE a
12	NO PIN	NO PIN	NO PIN	NO PIN
13	CATHODE b	CATHODE b	ANODE b	ANODE a
14	ANODE <sup>[3]</sup>	ANODE <sup>[3]</sup>	CATHODE <sup>[6]</sup>	ANODE b

### NOTES:

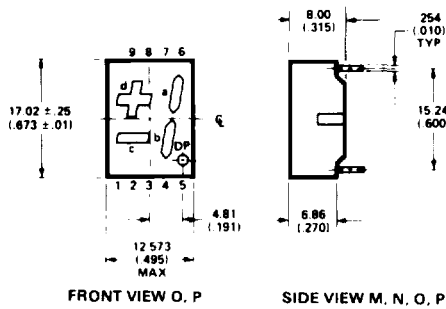
1. ALL DIMENSIONS IN MILLIMETRES (INCHES).
2. ALL UNTOLERANCED DIMENSIONS ARE FOR REFERENCE ONLY.
3. REDUNDANT ANODES.
4. UNUSED dp POSITION.
5. SEE INTERNAL CIRCUIT DIAGRAM.
6. REDUNDANT CATHODES.
7. SEE PART NUMBER TABLE FOR L.H.D.P. AND R.H.D.P. DESIGNATION.

SEVEN SEGMENT  
NUMERIC DISPLAYS

## Package Dimensions (continued)



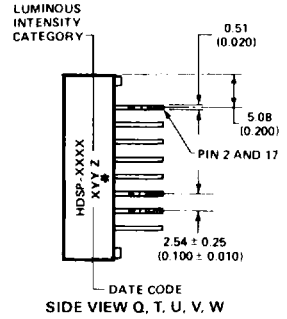
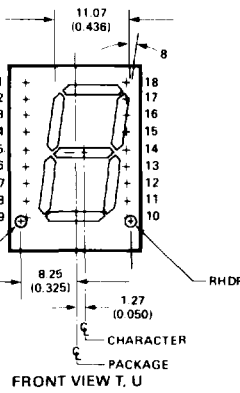
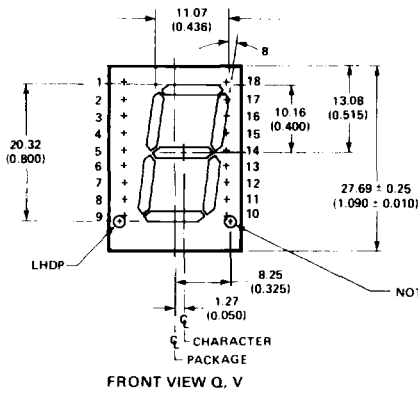
PIN	FUNCTION			
	M	N	O	P
1	CATHODE e	ANODE e	CATHODE c	ANODE c
2	CATHODE d	ANODE d	ANODE c, d	CATHODE c, d
3	ANODE f	CATHODE f	CATHODE b	ANODE b
4	CATHODE c	ANODE c	ANODE a, b, DP	CATHODE a, b, DP
5	CATHODE DP	ANODE DP	CATHODE DP	ANODE DP
6	CATHODE b	ANODE b	CATHODE a	ANODE a
7	CATHODE a	ANODE a	ANODE a, b, DP	CATHODE a, b, DP
8	ANODE f	CATHODE f	ANODE c, d	CATHODE c, d
9	CATHODE f	ANODE f	CATHODE d	ANODE d
10	CATHODE g	ANODE g	NO PIN	NO PIN



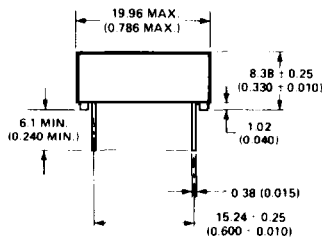
### NOTES:

1. ALL DIMENSIONS IN MILLIMETRES (INCHES).
2. MAXIMUM.
3. ALL UNTOLERANCED DIMENSIONS ARE FOR REFERENCE ONLY.
4. REDUNDANT ANODES.
5. REDUNDANT CATHODES.

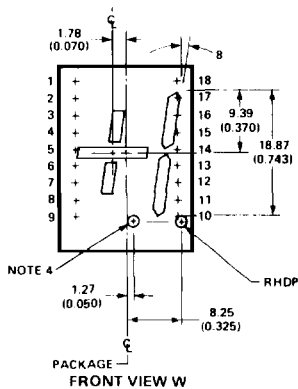
# Package Dimensions (continued)



\* The Side View of package indicates Country of Origin.



Pin	Function				
	Q	T	U	V	W
1	NO PIN	NO PIN	NO PIN	NO PIN	NO PIN
2	CATHODE a	CATHODE a	ANODE a	ANODE a	CATHODE a
3	CATHODE f	CATHODE f	ANODE f	ANODE f	ANODE d
4	ANODE <sup>1</sup>	ANODE <sup>1</sup>	CATHODE <sup>b</sup>	CATHODE <sup>b</sup>	CATHODE d
5	CATHODE e	CATHODE e	ANODE e	ANODE e	CATHODE c
6	ANODE <sup>1</sup>	ANODE <sup>1</sup>	CATHODE <sup>b</sup>	CATHODE <sup>b</sup>	CATHODE e
7	CATHODE dp	NO CONNEX	NO CONNEX	ANODE dp	ANODE e
8	NO PIN	NO PIN	NO PIN	NO PIN	CATHODE dp
9	NO PIN	NO PIN	NO PIN	NO PIN	NO PIN
10	NO PIN	CATHODE dp	ANODE dp	NO PIN	ANODE dp
11	CATHODE d	CATHODE d	ANODE d	ANODE d	CATHODE dp
12	ANODE <sup>1</sup>	ANODE <sup>1</sup>	CATHODE <sup>b</sup>	CATHODE <sup>b</sup>	CATHODE d
13	CATHODE c	CATHODE c	ANODE c	ANODE c	ANODE b
14	CATHODE g	CATHODE g	ANODE g	ANODE g	ANODE c
15	CATHODE b	CATHODE b	ANODE b	ANODE b	ANODE a
16	NO PIN	NO PIN	NO PIN	NO PIN	NO PIN
17	ANODE <sup>1</sup>	ANODE <sup>1</sup>	CATHODE <sup>b</sup>	CATHODE <sup>b</sup>	CATHODE a
18	NO PIN	NO PIN	NO PIN	NO PIN	NO PIN

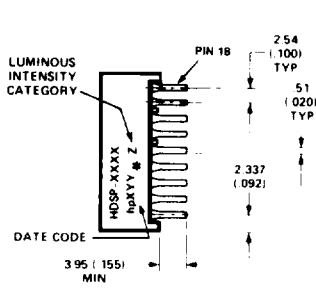


### NOTES:

1. ALL DIMENSIONS IN MILLIMETRES (INCHES).
2. ALL UNTOLERANCED DIMENSIONS ARE FOR REFERENCE ONLY.
3. REDUNDANT ANODES.
4. UNUSED dp POSITION.
5. SEE INTERNAL CIRCUIT DIAGRAM.
6. REDUNDANT CATHODES.
7. SEE PART NUMBER TABLE FOR L.H.D.P. AND R.H.D.P. DESIGNATION.

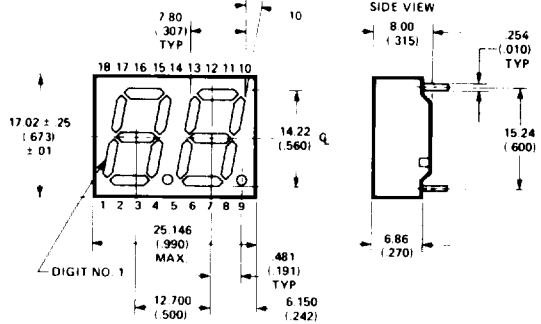
SEVEN-SEGMENT  
NUMERIC DISPLAYS

## Package Dimensions (continued)

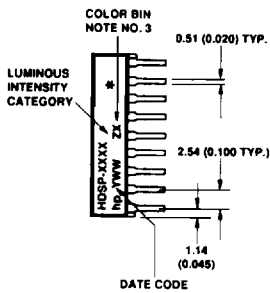


TOP END VIEW R, S

\*The Side View of package indicates Country of Origin.

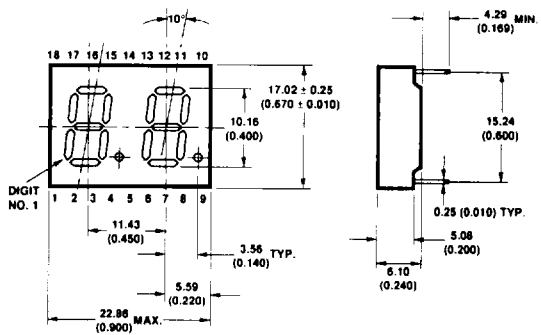


FRONT VIEW R, S



TOP END VIEW X, Y

\*The Side View of package indicates Country of Origin.

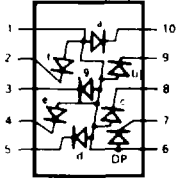


FRONT VIEW X, Y

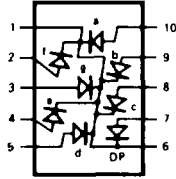
Pin	Function	
	R,X	S,Y
1	E CATHODE NO 1	E ANODE NO 1
2	D CATHODE NO 1	D ANODE NO 1
3	C CATHODE NO 1	C ANODE NO 1
4	DP CATHODE NO 1	DP ANODE NO 1
5	E CATHODE NO 2	E ANODE NO 2
6	D CATHODE NO 2	D ANODE NO 2
7	G CATHODE NO 2	G ANODE NO 2
8	C CATHODE NO 2	C ANODE NO 2
9	DP CATHODE NO 2	DP ANODE NO 2
10	B CATHODE NO 2	B ANODE NO 2
11	A CATHODE NO 2	A ANODE NO 2
12	F CATHODE NO 2	F ANODE NO 2
13	DIGIT NO 2 ANODE	DIGIT NO 2 CATHODE
14	DIGIT NO 1 ANODE	DIGIT NO 1 CATHODE
15	B CATHODE NO 1	B ANODE NO 1
16	A CATHODE NO 1	A ANODE NO 1
17	G CATHODE NO 1	G ANODE NO 1
18	F CATHODE NO 1	F ANODE NO 1

NOTES:  
 1. DIMENSIONS ARE IN MILLIMETRES (INCHES).  
 2. ALL UNTOLERANCED DIMENSIONS ARE FOR REFERENCE ONLY.  
 3. WHERE APPLICABLE.

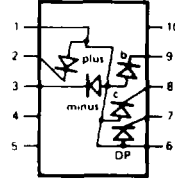
# Internal Circuit Diagram



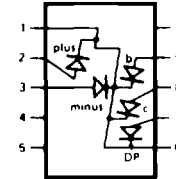
A, E



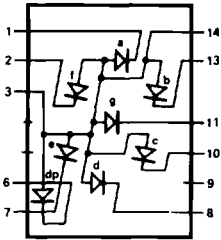
B, F



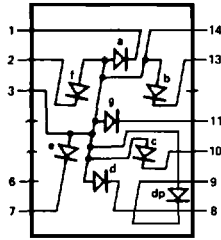
C, G



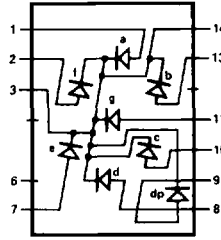
D, H



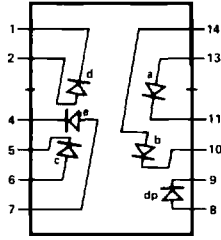
I



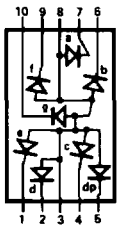
J



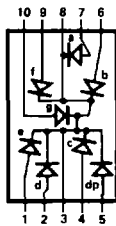
K



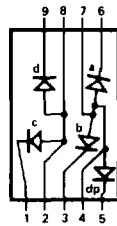
L



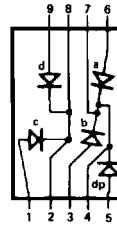
M



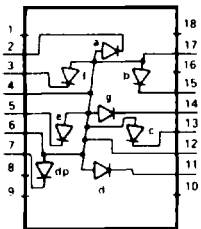
N



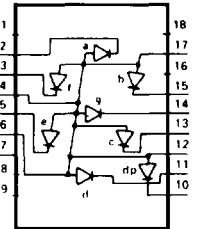
O



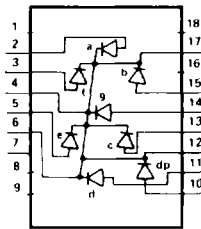
P



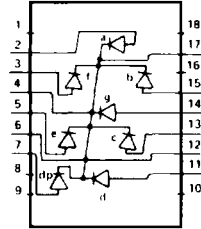
Q



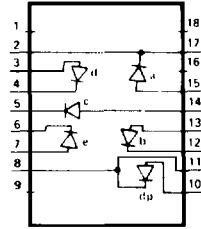
T



U



V

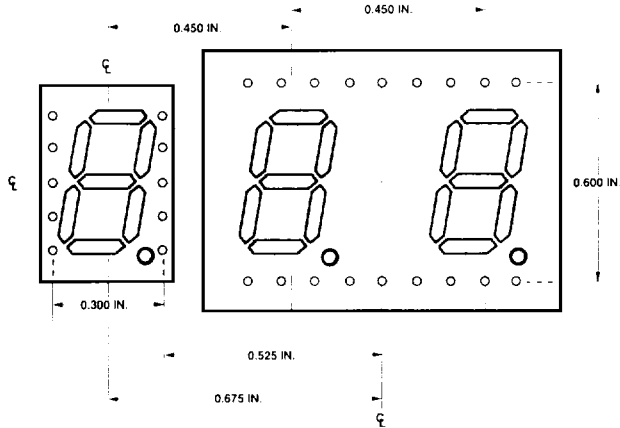
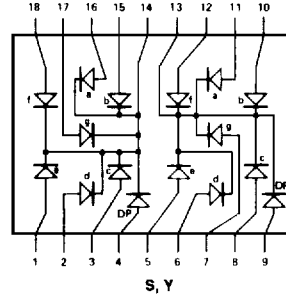
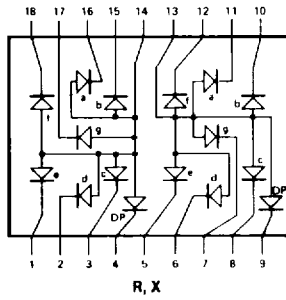


W

SEVEN SEGMENT  
NUMBER DISPLAYS



## Internal Circuit Diagram (continued)



HOLE PATTERN FOR PCB LAYOUT TO ACHIEVE UNIFORM 0.450 IN. DIGIT TO DIGIT PITCH. FOR HDSP-FXXX TO HDSP-QXXX.

## Absolute Maximum Ratings

Description	AlGaAs Red HDSP-A10X/E10X/ H10X/K12X/N10X/ F10X, G10X Series	HER HDSP-751X/ 335X/555X/ K70X Series	Yellow HDSP-A80X Series	Green HDSP-A90X Series	Units
Average Power per Segment or DP	37	52		64	mW
Peak Forward Current per Segment or DP	45				mA
DC Forward Current per Segment or DP	15 <sup>(1)</sup>	15 <sup>(2)</sup>			mA
Operating Temperature Range	-20 to +100	-40 to +100			°C
Storage Temperature Range	-55 to +100				°C
Reverse Voltage per Segment or DP	3.0				V
Lead Solder Temperature for 3 Seconds (1.60 mm [0.063 in.] below seating plane)	260				°C

### Notes:

- Derate above 91°C at 0.53 mA/°C.
- Derate HER/Yellow above 80°C at 0.38 mA/°C and Green above 71°C at 0.31 mA/°C.

### Electrical/Optical Characteristics at $T_A = 25^\circ\text{C}$

AlGaAs Red

Device Series HDSP-	Parameter	Symbol	Min.	Typ.	Max.	Units	Test Conditions	
A10X	Luminous Intensity/Segment <sup>(1,2)</sup> (Digit Average)	$I_V$		315	600		$\mu\text{cd}$	$I_P = 1 \text{ mA}$
					3600			$I_P = 5 \text{ mA}$
F10X, G10X				330	650			$I_P = 1 \text{ mA}$
					3900			$I_P = 5 \text{ mA}$
E10X				390	650			$I_P = 1 \text{ mA}$
					3900			$I_P = 5 \text{ mA}$
H10X, K12X				400	700			$I_P = 1 \text{ mA}$
					4200			$I_P = 5 \text{ mA}$
N10X				270	590			$I_P = 1 \text{ mA}$
					3500			$I_P = 5 \text{ mA}$
All Devices	Forward Voltage/Segment or DP	$V_F$			1.6		V	$I_P = 1 \text{ mA}$
					1.7			$I_P = 5 \text{ mA}$
					1.8	2.2		$I_P = 20 \text{ mA Pk}$
	Peak Wavelength	$\lambda_{\text{PEAK}}$		645		nm		
	Dominant Wavelength <sup>(3)</sup>	$\lambda_d$		637		nm		
	Reverse Voltage/Segment or DP <sup>(4)</sup>	$V_R$	3.0	15		V	$I_R = 100 \mu\text{A}$	
	Temperature Coefficient of $V_F$ /Segment or DP	$\Delta V_F/^\circ\text{C}$		-2 mV		mV/°C		
A10X	Thermal Resistance LED Junction-to-Pin	$R_{\theta J-PIN}$			255		°C/W/Seg	
F10X, G10X					320			
E10X					340			
H10X, K12X					400			
N10X					430			

SEVEN SEGMENT NUMBER C DISPLAYS

### High Efficiency Red

Device Series HDSP-	Parameter	Symbol	Min.	Typ.	Max.	Units	Test Conditions
751X	Luminous Intensity/Segment <sup>(1,2)</sup> (Digit Average)	$I_V$	160	270		$\mu\text{cd}$	$I_F = 2 \text{ mA}$
				1050			$I_F = 5 \text{ mA}$
335X, 555X, K70X			200	300			$I_F = 2 \text{ mA}$
				1200			$I_F = 5 \text{ mA}$
			270	370			$I_F = 2 \text{ mA}$
				1480			$I_F = 5 \text{ mA}$
All Devices	Forward Voltage/Segment or DP	$V_F$		1.6		V	$I_F = 2 \text{ mA}$
				1.7			$I_F = 5 \text{ mA}$
				2.1	2.5		$I_F = 20 \text{ mA Pk}$
	Peak Wavelength	$\lambda_{\text{PEAK}}$		635		nm	
	Dominant Wavelength <sup>(3)</sup>	$\lambda_d$		626		nm	
	Reverse Voltage/Segment or DP <sup>(4)</sup>	$V_R$	3.0	30		V	$I_R \approx 100 \mu\text{A}$
	Temperature Coefficient of $V_F$ /Segment or DP	$\Delta V_F/^\circ\text{C}$		-2		mV/°C	
751X	Thermal Resistance LED Junction-to-Pin	$R\theta_{J-PIN}$		200		°C/W	
335X				280			
555X, K70X				345			

## Yellow

Device Series HDSP-	Parameter	Symbol	Min.	Typ.	Max.	Units	Test Conditions
A80X	Luminous Intensity/Segment <sup>(1,2)</sup> (Digit Average)	$I_V$	250	420		$\mu\text{cd}$	$I_p = 4 \text{ mA}$
				1300			$I_p = 10 \text{ mA}$
	Forward Voltage/Segment or DP	$V_F$		1.7		V	$I_p = 4 \text{ mA}$
				1.8			$I_p = 5 \text{ mA}$
				2.1	2.5		$I_p = 20 \text{ mA Pk}$
	Peak Wavelength	$\lambda_{\text{PEAK}}$		583		nm	
	Dominant Wavelength <sup>(3,5)</sup>	$\lambda_d$	581.5	585	592.5	nm	
	Reverse Voltage/Segment or DP <sup>(4)</sup>	$V_R$	3.0	30		V	$I_R = 100 \mu\text{A}$
Temperature Coefficient of $V_F$ /Segment or DP	$\Delta V_F / ^\circ\text{C}$		-2		mV/ $^\circ\text{C}$		
Thermal Resistance LED Junction-to-Pin	$R\theta_{J-PIN}$		200		$^\circ\text{C/W}$		

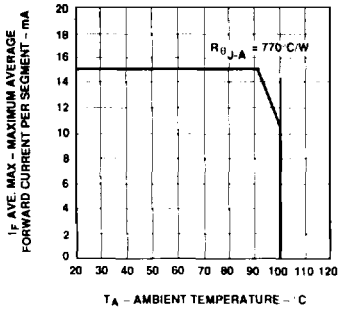
## Green

Device Series HDSP-	Parameter	Symbol	Min.	Typ.	Max.	Units	Test Conditions
A90X	Luminous Intensity/Segment <sup>(1,2)</sup> (Digit Average)	$I_V$	250	475		$\mu\text{cd}$	$I_p = 4 \text{ mA}$
				1500			$I_p = 10 \text{ mA}$
	Forward Voltage/Segment or DP	$V_F$		1.9		V	$I_p = 4 \text{ mA}$
				2.0			$I_p = 10 \text{ mA}$
				2.1	2.5		$I_p = 20 \text{ mA Pk}$
	Peak Wavelength	$\lambda_{\text{PEAK}}$		566		nm	
	Dominant Wavelength <sup>(3,5)</sup>	$\lambda_d$		571	577	nm	
	Reverse Voltage/Segment or DP <sup>(4)</sup>	$V_R$	3.0	30		V	$I_R = 100 \mu\text{A}$
Temperature Coefficient of $V_F$ /Segment or DP	$\Delta V_F / ^\circ\text{C}$		-2		mV/ $^\circ\text{C}$		
Thermal Resistance LED Junction-to-Pin	$R\theta_{J-PIN}$		200		$^\circ\text{C/W}$		

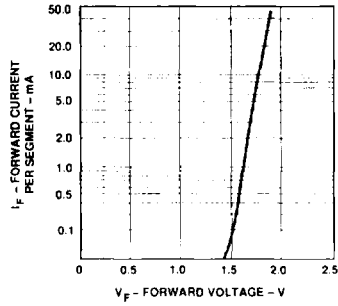
### Notes:

1. Device case temperature is 25°C prior to the intensity measurement.
2. The digits are categorized for luminous intensity. The intensity category is designated by a letter on the side of the package.
3. The dominant wavelength,  $\lambda_d$ , is derived from the CIE chromaticity diagram and is the single wavelength which defines the color of the device.
4. Typical specification for reference only. Do not exceed absolute maximum ratings.
5. The yellow (HDSP-A800) and Green (HDSP-A900) displays are categorized for dominant wavelength. The category is designated by a number adjacent to the luminous intensity category letter.

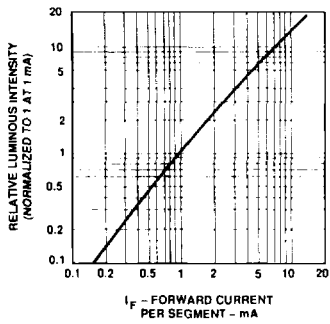
## AlGaAs Red



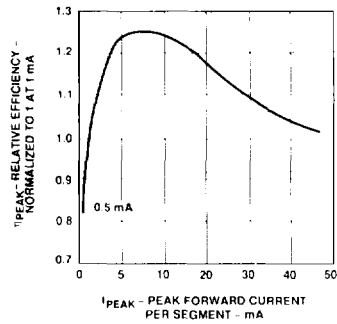
**Figure 1. Maximum Allowable Average or DC Current vs. Ambient Temperature.**



**Figure 2. Forward Current vs. Forward Voltage.**

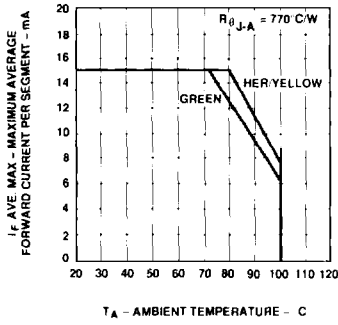


**Figure 3. Relative Luminous Intensity vs. DC Forward Current.**

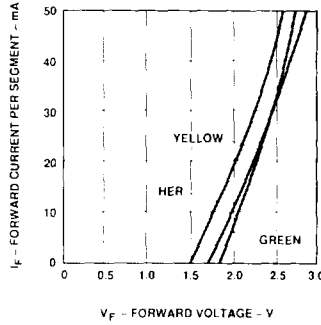


**Figure 4. Relative Efficiency (Luminous Intensity per Unit Current) vs. Peak Current.**

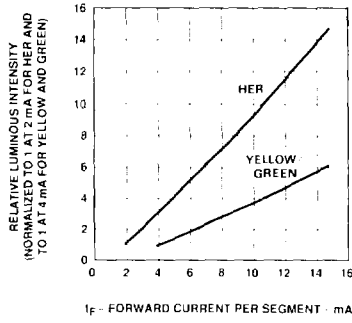
**HER, Yellow, Green**



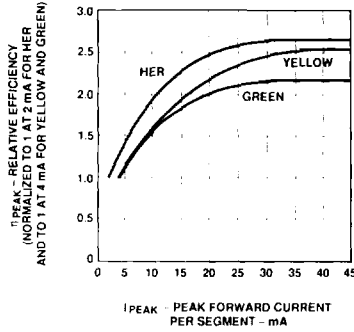
**Figure 5. Maximum Allowable Average or DC Current vs. Ambient Temperature.**



**Figure 6. Forward Current vs. Forward Voltage.**



**Figure 7. Relative Luminous Intensity vs. DC Forward Current.**



**Figure 8. Relative Efficiency (Luminous Intensity per Unit Current) vs. Peak Current.**

SEVEN SEGMENT  
NUMERIC DISPLAYS

### **Electrical/Optical**

For more information on electrical/optical characteristics, please see Application Note 1005.

### **Contrast Enhancement**

For information on contrast enhancement please see Application Note 1015.

### **Soldering/Cleaning**

Cleaning agents from the ketone family (acetone, methyl ethyl ketone, etc.) and from the chlorinated hydrocarbon family (methylene chloride, trichloroethylene, carbon tetrachloride, etc.) are not recommended for cleaning LED parts. All of these various solvents attack or dissolve the encapsulating epoxies used to form the package of plastic LED parts.

For information on soldering LEDs please refer to Application Note 1027.