

SFH615A-1X, SFH615A-2X, SFH615A-3X,  
SFH615A-4X, SFH615A-1, SFH615A-2,  
SFH615A-3, SFH615A-4



# ISOCOM

COMPONENTS



## LOW INPUT CURRENT PHOTOTRANSISTOR OPTICALLY COUPLED ISOLATORS

### APPROVALS

- UL recognised, File No. E91231  
Package Code " EE "

### 'X' SPECIFICATION APPROVALS

- VDE 0884 in 3 available lead form : -  
- STD  
- G form  
- SMD approved to CECC 00802
- Certified to EN60950 by Nemko  
Certificate No. P01102465

### DESCRIPTION

The SFH615A series of optically coupled isolators consist of infrared light emitting diodes and NPN silicon photo transistors in space efficient dual in line plastic packages.

### FEATURES

- Options :-  
10mm lead spread - add G after part no.  
Surface mount - add SM after part no.  
Taper & reel - add SMT&R after part no.
- Low input current 1mA  $I_F$
- High Current Transfer Ratios
- High Isolation Voltage (5.3kV<sub>RMS</sub>, 7.5kV<sub>PK</sub>)
- High BV<sub>CEO</sub> (70V min)
- All electrical parameters 100% tested

### APPLICATIONS

- Computer terminals
- Industrial systems controllers
- Measuring instruments

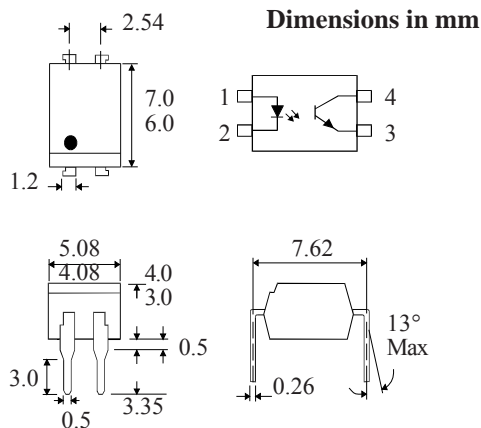

### ABSOLUTE MAXIMUM RATINGS (25°C unless otherwise specified)

Storage Temperature \_\_\_\_\_ -55°C to +125°C  
Operating Temperature \_\_\_\_\_ -30°C to +100°C  
Lead Soldering Temperature  
(1/16 inch (1.6mm) from case for 10 secs) 260°C

### INPUT DIODE

Forward Current \_\_\_\_\_ 50mA  
Reverse Voltage \_\_\_\_\_ 6V  
Power Dissipation \_\_\_\_\_ 70mW

### OUTPUT TRANSISTOR

Collector-emitter Voltage BV<sub>CEO</sub> \_\_\_\_\_ 70V  
Emitter-collector Voltage BV<sub>ECO</sub> \_\_\_\_\_ 6V  
Collector Current \_\_\_\_\_ 50mA  
Power Dissipation \_\_\_\_\_ 150mW

### POWER DISSIPATION

Total Power Dissipation \_\_\_\_\_ 200mW  
(derate linearly 2.67mW/°C above 25°C)

#### OPTION SM SURFACE MOUNT

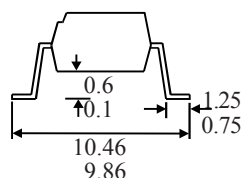

#### OPTION G

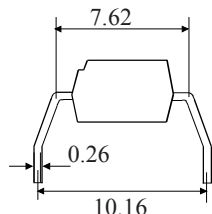

### ISOCOM COMPONENTS 2004 LTD

Unit 25B, Park View Road West,  
Park View Industrial Estate, Brenda Road  
Hartlepool, Cleveland, TS25 1UD  
Tel: (01429) 863609 Fax: (01429) 863581

**ELECTRICAL CHARACTERISTICS (  $T_A = 25^\circ\text{C}$  Unless otherwise noted )**

PARAMETER		MIN	TYP	MAX	UNITS	TEST CONDITION
Input	Forward Voltage ( $V_F$ )			1.65	V	$I_F = 50\text{mA}$
	Reverse Current ( $I_R$ )			10	$\mu\text{A}$	$V_R = 6\text{V}$
Output	Collector-emitter Breakdown ( $BV_{CEO}$ ) ( Note 2 )	70			V	$I_C = 1\text{mA}$
	Emitter-collector Breakdown ( $BV_{ECO}$ )	6			V	$I_E = 100\mu\text{A}$
	Collector-emitter Dark Current ( $I_{CEO}$ ) SFH615A-1,2 SFH615A-3,4			50 100	nA nA	$V_{CE} = 10\text{V}$
Coupled	Current Transfer Ratio (CTR) (Note 2)					
	SFH615A-1	40		80	%	$10\text{mA } I_F, 5\text{V } V_{CE}$
	SFH615A-2	63		125	%	
	SFH615A-3	100		200	%	
	SFH615A-4	160		320	%	
	SFH615A-1	13			%	$1\text{mA } I_F, 5\text{V } V_{CE}$
	SFH615A-2	22			%	
	SFH615A-3	34			%	
SFH615A-4	56			%		
	Collector-emitter Saturation Voltage $V_{CESAT}$			0.4	V	$10\text{mA } I_F, 2.5\text{mA } I_C$
	Input to Output Isolation Voltage $V_{ISO}$	5300 7500			$V_{RMS}$ $V_{PK}$	See note 1 See note 1
	Input-output Isolation Resistance $R_{ISO}$	$5 \times 10^{10}$			$\Omega$	$V_{IO} = 500\text{V}$ (note 1)

- Note 1 Measured with input leads shorted together and output leads shorted together.  
 Note 2 Special Selections are available on request. Please consult the factory.

**TYPICAL SWITCHING CHARACTERISTICS**

1. Linear Operation (without saturation) Fig 1.  
 $I_F = 10\text{mA}, V_{CC} = 5\text{V}, R_L = 75\Omega$

			UNITS
Turn-on Time	$t_{on}$	3.0	$\mu\text{s}$
Rise Time	$t_r$	2.0	$\mu\text{s}$
Turn-off Time	$t_{off}$	2.3	$\mu\text{s}$
Fall Time	$t_f$	2.0	$\mu\text{s}$
Cut-off Frequency	$F_{CO}$	250	kHz

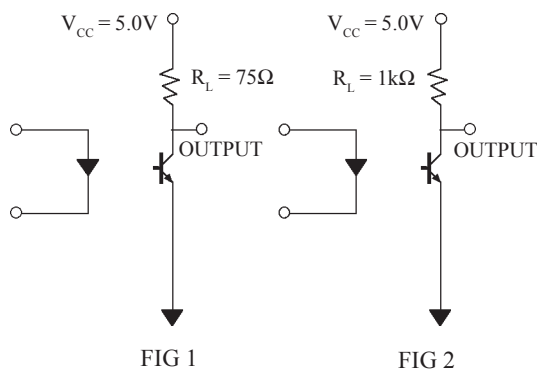

2. Switching Operation (with saturation) Fig 2  
 $V_{CC} = 5\text{V}, R_L = 1\text{k}\Omega$

GROUP	-1 ( $I_F = 20\text{mA}$ )	-2 and -3 ( $I_F = 10\text{mA}$ )	-4 ( $I_F = 5\text{mA}$ )	UNITS	
Turn-on Time	$t_{on}$	3.0	4.2	6.0	$\mu\text{s}$
Rise Time	$t_r$	2.0	3.0	4.6	$\mu\text{s}$
Turn-off Time	$t_{off}$	18	23	25	$\mu\text{s}$
Fall Time	$t_f$	11	14	15	$\mu\text{s}$
$V_{CESAT}$				$\leq 0.4$	V

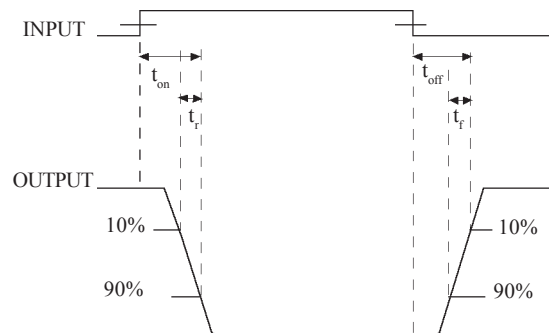

**Collector Power Dissipation vs. Ambient Temperature**

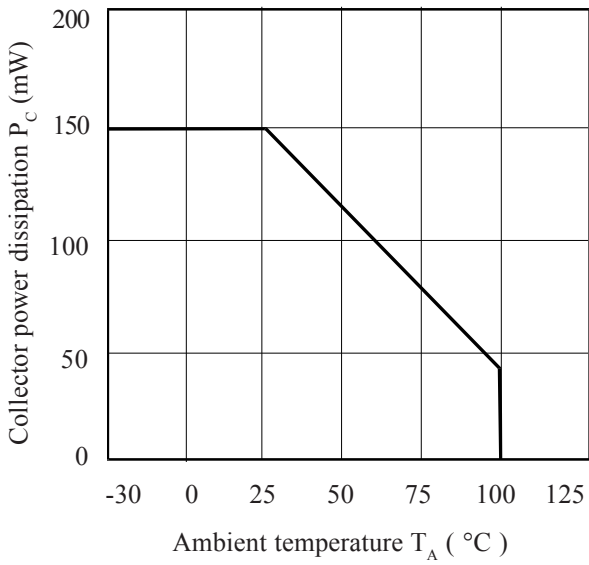

**Collector Current vs. Collector-emitter Voltage (normalised to SFH615A-3)**

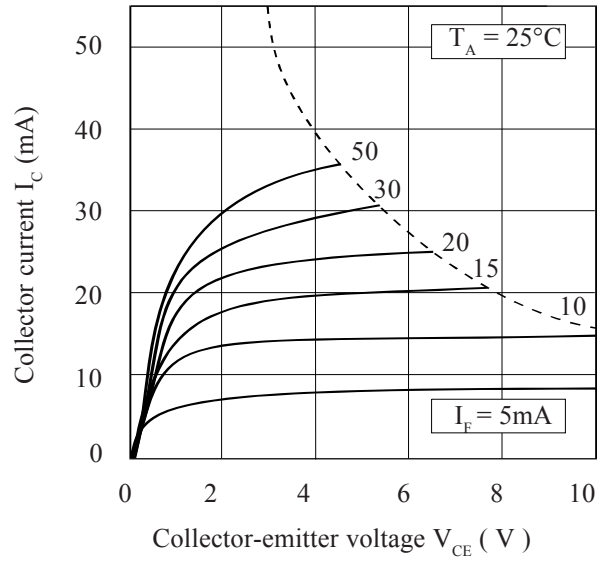

**Forward Current vs. Ambient Temperature**

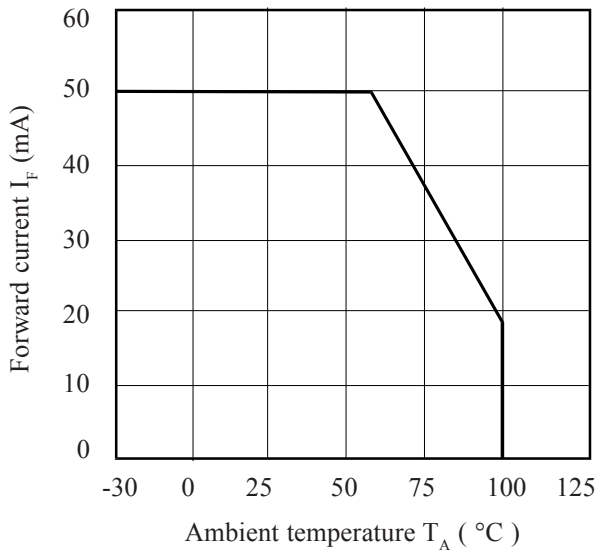

**Current Transfer Ratio vs. Forward Current**

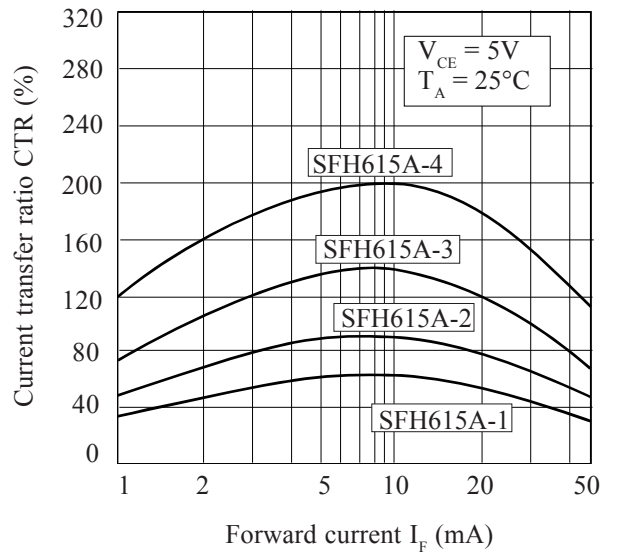

**Relative Current Transfer Ratio vs. Ambient Temperature**

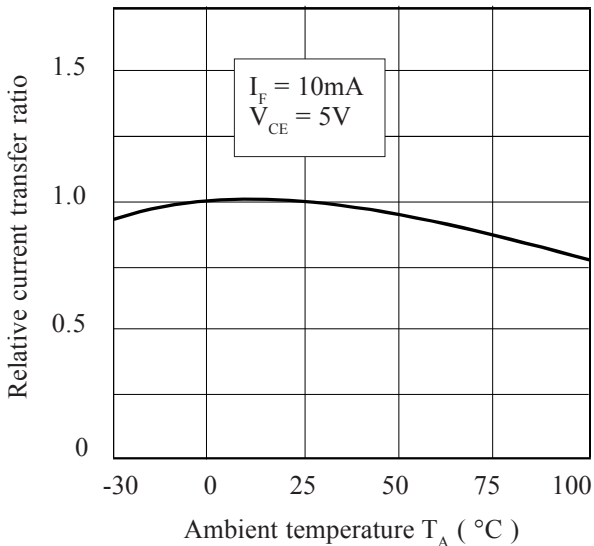

**Collector-emitter Saturation Voltage vs. Ambient Temperature**

