

DATA SHEET

1N5221B~1N5267B

SILICON ZENER DIODES

VOLTAGE 2.4 to 75 Volts

POWER 500 mWatts

DO-35

Unit: inch (mm)

FEATURES

- Planar Die construction
- 500mW Power Dissipation
- Ideally Suited for Automated Assembly Processes
- In compliance with EU RoHS 2002/95/EC directives

MECHANICAL DATA

- Case: Molded Glass DO-35
- Terminals: Solderable per MIL-STD-750, Method 2026
- Polarity: See Diagram Below
- Approx. Weight: 0.13 grams
- Mounting Position: Any
- Ordering information: Suffix : " -35 " to order DO-35 Package
- Packing information
 - B - 2K per Bulk box
 - T/R - 10K per 13" plastic Reel
 - T/B - 5K per horiz. tape & Ammo box

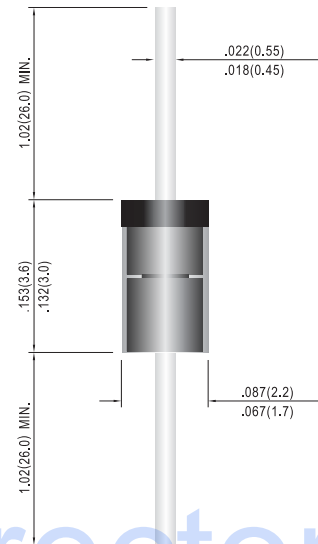

MAXIMUM RATINGS AND ELECTRICAL CHARACTERISTICS

Parameter	Symbol	Value	Units
Power Dissipation at $T_{amb} = 25^\circ C$	P_{TOT}	500	mW
Junction Temperature	T_J	175	$^\circ C$
Storage Temperature Range	T_S	-65 to +175	$^\circ C$

Valid provided that leads at a distance of 8mm from case are kept at ambient temperature.

Parameter	Symbol	Min.	Typ.	Max.	Units
Thermal Resistance Junction to Ambient Air	$R_{\theta JA}$	--	--	0.3*	K/mW
Forward Voltage at $I_F = 200mA$	V_F	--	--	1.1	V

Valid provided that leads at a distance of 10 mm from case are kept at ambient temperature.

Part Number	Nominal Zener Voltage			Max. Zener Impedance				Max Reverse Leakage Current		Marking code
	V _Z @ I _{ZT}			Z _{ZT} @ I _{ZT}		Z _{ZK} @ I _{ZK}		I _R @ V _R		
	Nom. V	Min. V	Max. V	Ω	mA	Ω	mA	uA	V	
1N5221B	2.4	2.28	2.52	30	20	1200	0.25	100	1	1N5221B
1N5222B	2.5	2.38	2.63	30	20	1250	0.25	100	1	1N5222B
1N5223B	2.7	2.57	2.84	30	20	1300	0.25	75	1	1N5223B
1N5224B	2.8	2.66	2.94	30	20	1400	0.25	75	1	1N5224B
1N5225B	3	2.85	3.15	29	20	1600	0.25	50	1	1N5225B
1N5226B	3.3	3.14	3.47	28	20	1600	0.25	25	1	1N5226B
1N5227B	3.6	3.42	3.78	24	20	1700	0.25	15	1	1N5227B
1N5228B	3.9	3.71	4.1	23	20	1900	0.25	10	1	1N5228B
1N5229B	4.3	4.09	4.52	22	20	2000	0.25	5	1	1N5229B
1N5230B	4.7	4.47	4.94	19	20	1900	0.25	5	2	1N5230B
1N5231B	5.1	4.85	5.36	17	20	1600	0.25	5	2	1N5231B
1N5232B	5.6	5.32	5.88	11	20	1600	0.25	5	3	1N5232B
1N5233B	6.0	5.7	6.3	7	20	1600	0.25	5	3.5	1N5233B
1N5234B	6.2	5.89	6.51	7	20	1000	0.25	5	4	1N5234B
1N5235B	6.8	6.46	7.14	5	20	750	0.25	3	5	1N5235B
1N5236B	7.5	7.13	7.88	6	20	500	0.25	3	6	1N5236B
1N5237B	8.2	7.79	8.61	8	20	500	0.25	3	6.5	1N5237B
1N5238B	8.7	8.27	9.14	8	20	600	0.25	3	6.5	1N5238B
1N5239B	9.1	8.65	9.56	10	20	600	0.25	3	7	1N5239B
1N5240B	10	9.5	10.5	17	20	600	0.25	3	8	1N5240B
1N5241B	11	10.45	11.55	22	20	600	0.25	2	8.4	1N5241B
1N5242B	12	11.4	12.6	30	20	600	0.25	1	9.1	1N5242B
1N5243B	13	12.35	13.65	13	9.5	600	0.25	0.5	9.9	1N5243B
1N5244B	14	13.3	14.7	15	9	600	0.25	0.1	10	1N5244B
1N5245B	15	14.25	15.75	16	8.5	600	0.25	0.1	11	1N5245B
1N5246B	16	15.2	16.8	17	7.8	600	0.25	0.1	12	1N5246B
1N5247B	17	16.15	17.85	19	7.4	600	0.25	0.1	13	1N5247B
1N5248B	18	17.1	18.9	21	7	600	0.25	0.1	14	1N5248B
1N5249B	19	18.05	19.95	23	6.6	600	0.25	0.1	14	1N5249B
1N5250B	20	19	21	25	6.2	600	0.25	0.1	15	1N5250B
1N5251B	22	20.9	23.1	29	5.6	600	0.25	0.1	17	1N5251B
1N5252B	24	22.8	25.2	33	5.2	600	0.25	0.1	18	1N5252B
1N5253B	25	23.75	26.25	35	5	600	0.25	0.1	19	1N5253B
1N5254B	27	25.65	28.35	41	4.6	600	0.25	0.1	21	1N5254B
1N5255B	28	26.6	29.4	44	4.5	600	0.25	0.1	21	1N5255B
1N5256B	30	28.5	31.5	49	4.2	600	0.25	0.1	23	1N5256B
1N5257B	33	31.35	34.65	58	3.8	700	0.25	0.1	25	1N5257B
1N5258B	36	34.2	37.8	70	3.4	700	0.25	0.1	27	1N5258B
1N5259B	39	37.05	40.95	80	3.2	800	0.25	0.1	30	1N5259B
1N5260B	43	40.85	45.15	93	3	900	0.25	0.1	33	1N5260B
1N5261B	47	44.65	49.35	150	2.7	1000	0.25	0.1	36	1N5261B
1N5262B	51	48.45	53.55	125	2.5	1100	0.25	0.1	39	1N5262B
1N5263B	56	53.2	58.8	150	2.2	1300	0.25	0.1	43	1N5263B
1N5264B	60	57	63	170	2.1	1400	0.25	0.1	46	1N5264B
1N5265B	62	58.9	65.1	185	2	1400	0.25	0.1	47	1N5265B
1N5266B	68	64.6	71.4	230	1.8	1600	0.25	0.1	52	1N5266B
1N5267B	75	71.25	78.75	270	1.7	1700	0.25	0.1	56	1N5267B

STANDARD VOLTAGE TOLERANCE IS ± 5% AND:

SUFFIX "A" FOR ± 3%

SUFFIX "B" FOR ± 5%

SUFFIX "C" FOR ± 10%

SUFFIX "D" FOR ± 20%

* MEASURED WITH PULSES T_p=40 mSec.

ZENER DIODE NUMBERING SYSTEM:

1N5225B B

1* 2*

1* TYPE NO.

2* TOLERANCE OF V_Z

3* e.g., 1N5225B=3.0V ± 5%

RATING AND CHARACTERISTIC CURVES

