

SFH617A-1, SFH617A-2, SFH617A-3, SFH617A-4,
SFH617A-1X, SFH617A-2X, SFH617A-3X, SFH617A-4X



ISOCOM
COMPONENTS

**LOW INPUT CURRENT
PHOTOTRANSISTOR
OPTICALLY COUPLED ISOLATORS**

APPROVALS

- UL recognised, File No. E91231
Package Code " EE "

'X' SPECIFICATION APPROVALS

- VDE 0884 in 3 available lead form : -
- STD
- G form
- SMD approved to CECC 00802

DESCRIPTION

The SFH617A series of optically coupled isolators consist of infrared light emitting diodes and NPN silicon photo transistors in space efficient dual in line plastic packages.

FEATURES

- Options :-
10mm lead spread - add G after part no.
Surface mount - add SM after part no.
Tape&reel - add SMT&R after part no.
- Low input current 1mA I_F
- High Current Transfer Ratios (40-320% at 10mA, 13% min at 1mA)
- High Isolation Voltage (5.3kV_{RMS}, 7.5kV_{PK})
- High BV_{CEO} (70V min)
- All electrical parameters 100% tested

APPLICATIONS

- Computer terminals
- Industrial systems controllers
- Measuring instruments
- Signal transmission between systems of different potentials and impedances

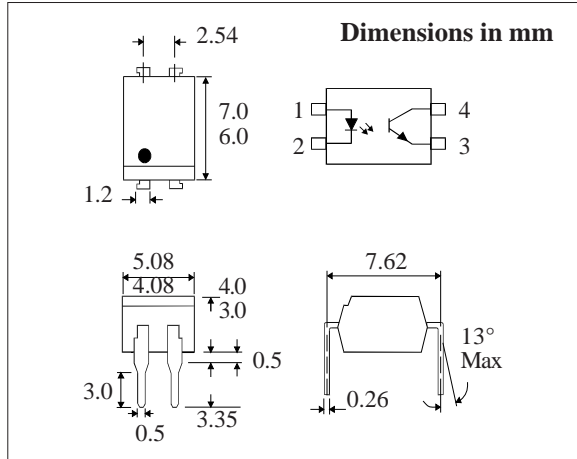

**ABSOLUTE MAXIMUM RATINGS
(25°C unless otherwise specified)**

Storage Temperature _____ -55°C to +125°C
Operating Temperature _____ -30°C to +100°C
Lead Soldering Temperature
(1/16 inch (1.6mm) from case for 10 secs) 260°C

INPUT DIODE

Forward Current _____ 50mA
Reverse Voltage _____ 6V
Power Dissipation _____ 70mW

OUTPUT TRANSISTOR

Collector-emitter Voltage BV_{CEO} _____ 70V
Emitter-collector Voltage BV_{ECO} _____ 6V
Collector Current _____ 50mA
Power Dissipation _____ 150mW

POWER DISSIPATION

Total Power Dissipation _____ 200mW
(derate linearly 2.67mW/°C above 25°C)

**OPTION SM
SURFACE MOUNT**

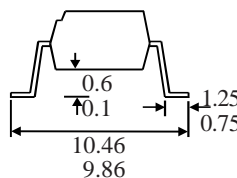

OPTION G

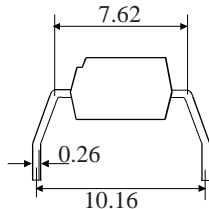

ISOCOM COMPONENTS LTD
Unit 25B, Park View Road West,
Park View Industrial Estate, Brenda Road
Hartlepool, Cleveland, TS25 1UD
Tel: (01429) 863609 Fax: (01429) 863581

ELECTRICAL CHARACTERISTICS ($T_A = 25^\circ\text{C}$ Unless otherwise noted)

PARAMETER		MIN	TYP	MAX	UNITS	TEST CONDITION	
Input	Forward Voltage (V_F)			1.65	V	$I_F = 50\text{mA}$	
	Reverse Current (I_R)			10	μA	$V_R = 6\text{V}$	
Output	Collector-emitter Breakdown (BV_{CEO}) (Note 2)	70			V	$I_C = 1\text{mA}$	
	Emitter-collector Breakdown (BV_{ECO})	6			V	$I_E = 100\mu\text{A}$	
	Collector-emitter Dark Current (I_{CEO}) SFH617A-1,2 SFH617A-3,4			50 100	nA nA	$V_{CE} = 10\text{V}$	
Coupled	Current Transfer Ratio (CTR) (Note 2) SFH617A-1 SFH617A-2 SFH617A-3 SFH617A-4	40		80	%	$10\text{mA } I_F, 5\text{V } V_{CE}$	
		63		125	%		
		100		200	%		
		160		320	%		
	SFH617A-1 SFH617A-2 SFH617A-3 SFH617A-4	13				%	$1\text{mA } I_F, 5\text{V } V_{CE}$
		22				%	
		34				%	
		56				%	
	Collector-emitter Saturation Voltage V_{CESAT}			0.4	V	$10\text{mA } I_F, 2.5\text{mA } I_C$	
	Input to Output Isolation Voltage V_{ISO}	5300 7500			V_{RMS} V_{PK}	See note 1 See note 1	
Input-output Isolation Resistance R_{ISO}	5×10^{10}			Ω	$V_{IO} = 500\text{V}$ (note 1)		
Response Time (Rise), tr		4		μS	$V_{CE} = 2\text{V}, I_C = 2\text{mA}$ $R_L = 100\Omega$		
Response Time (Fall), tf		3		μS			

Note 1 Measured with input leads shorted together and output leads shorted together.

Note 2 Special Selections are available on request. Please consult the factory.

Collector Power Dissipation vs. Ambient Temperature

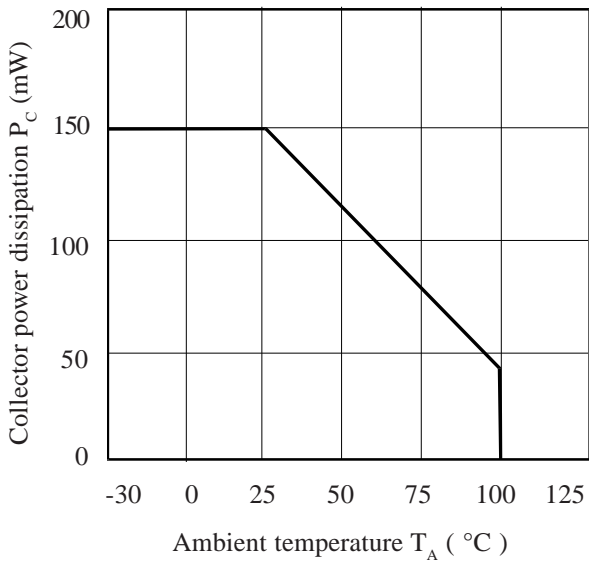

Collector Current vs. Collector-emitter Voltage (normalised to SFH617A-3)

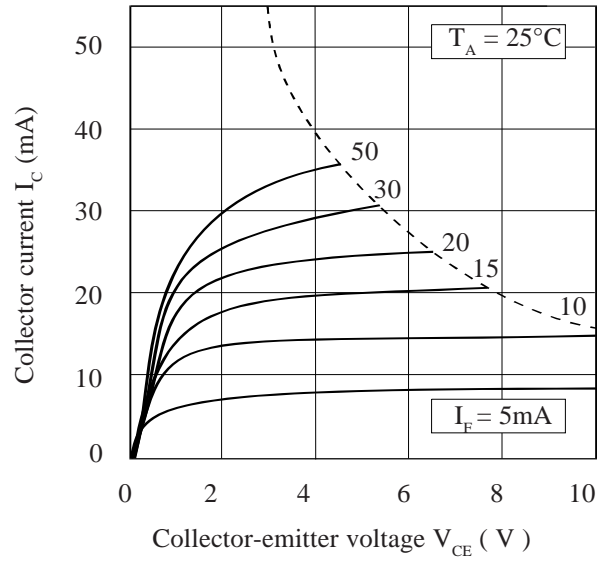

Forward Current vs. Ambient Temperature

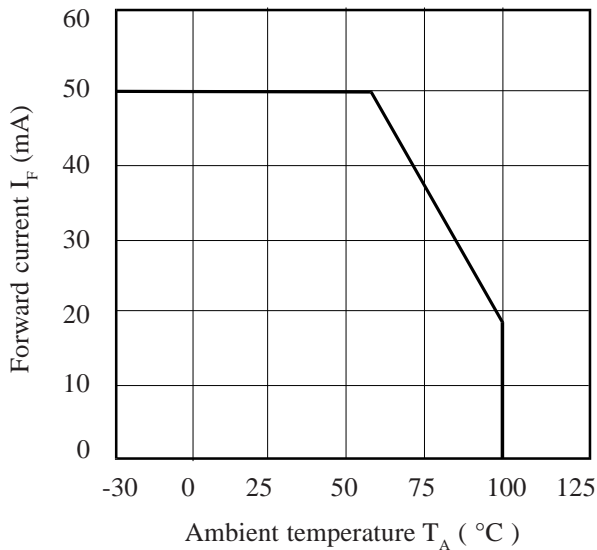

Current Transfer Ratio vs. Forward Current

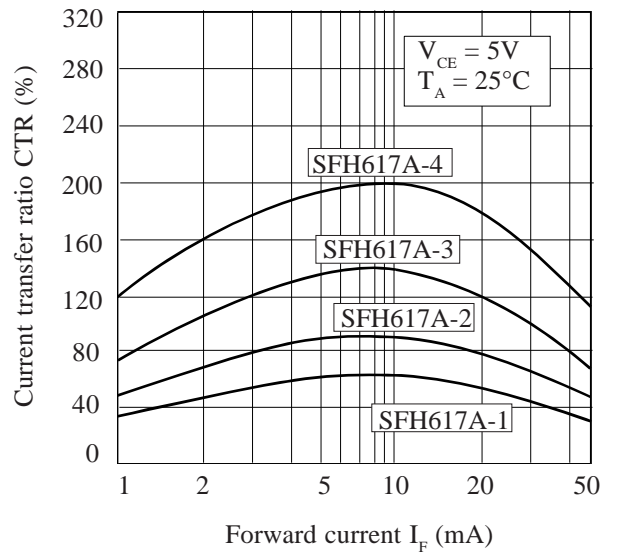

Relative Current Transfer Ratio vs. Ambient Temperature

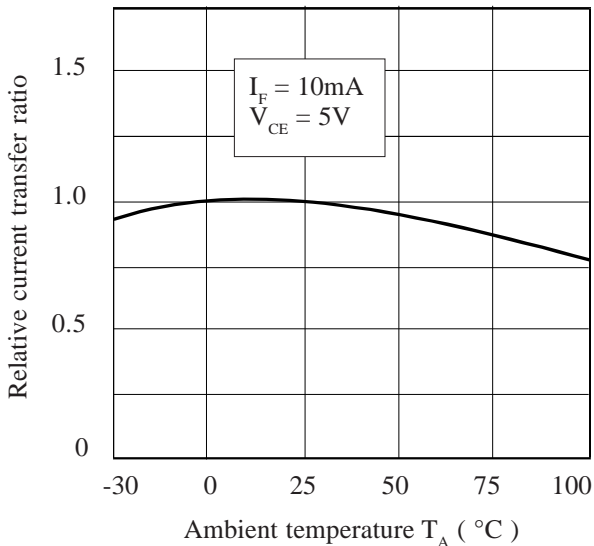

Collector-emitter Saturation Voltage vs. Ambient Temperature

