



### Features

- Un-cooled laser diode with multi-quantum-well structure
- High temperature operation without active cooling
- Hermetically sealed active component
- Built-in InGaAs monitor photodiode
- Complies with Telcordia Technologies GR-468-CORE
- Single frequency operation with high SMSR
- TOSA
- FC/ST/SC receptacle package with 2-hole flange
- Fiber pigtailed with FC/ST/SC/MU/LC connector
- Design for 2.5Gbps high speed optic networks
- RoHS Compliant available

### Absolute Maximum Ratings (Tc=25°C)

Parameter	Symbol	Rating	Unit
Fiber Output Power L/M/H/2	P <sub>f</sub>	1(L)/1.5(M)/2.5(H)/3(2)	mW
LD Reverse Voltage	V <sub>RLD</sub>	2	V
PD Reverse Voltage	V <sub>RPD</sub>	10	V
PD Forward Current	I <sub>FPD</sub>	2	mA
Operating Temperature	T <sub>opr</sub>	0 ~ 70	°C
Storage Temperature	T <sub>stg</sub>	-40 ~ 85	°C

### (All optical data refer to a coupled 9/125 μm SM fiber)

### Optical and Electrical Characteristics (Tc=25°C)

Parameter	Symbol	Min.	Typ.	Max.	Unit	Notes
Threshold Current	I <sub>th</sub>	-	10	15	mA	CW
Optical Output Power	P <sub>f</sub>	0.2 0.5 1 2	- - 1.6 2.5	0.5 1 - -	mW	CW, I <sub>th</sub> +20mA, kink free
Peak Wavelength	λ	1295	1310	1325	nm	Note 3
Side mode Suppression	S <sub>r</sub>	30	35	-	dB	CW, P <sub>f</sub> = P <sub>f</sub> (Min), 0 ~ 70°C
Forward Voltage	V <sub>F</sub>	-	1.2	1.5	V	CW, P <sub>f</sub> = P <sub>f</sub> (Min)
Rise / Fall Time	T <sub>r</sub> / T <sub>f</sub>	-	-	150	ps	I <sub>bias</sub> =I <sub>th</sub> , 20~80% Lead length=1mm
Tracking Error	ΔP <sub>f</sub> /P <sub>f</sub>	-1.5	-	1.5	dB	APC, 0 ~ 70°C
PD Monitor Current	I <sub>m</sub>	100	-	-	μA	CW, P <sub>f</sub> = P <sub>f</sub> (Min), V <sub>RPD</sub> = 2V
PD Dark Current	I <sub>dark</sub>	-	-	0.1	μA	V <sub>RPD</sub> = 5V
PD Capacitance	C <sub>t</sub>	-	6	15	pF	V <sub>RPD</sub> = 5V, f = 1MHz

**Note:**

1. Pin assignment can be customized.
2. Specifications subject to change without notice.
3. Selected wavelength is available for WDM application.

**Pin Assignment**



- Pin 1 : Laser Cathode
- Pin 2 : Laser Anode and Case Gnd
- Pin 3 : Monitor Diode Anode
- Pin 4 : Monitor Diode Cathode



- Pin 1 : Monitor Diode Anode
- Pin 2 : Laser Anode and Case Gnd
- Pin 3 : Laser Cathode
- Pin 4 : Monitor Diode Cathode



- Pin 1 : Laser Anode and Monitor Diode Cathode
- Pin 2 : Case Gnd
- Pin 3 : Laser Cathode
- Pin 4 : Monitor Diode Anode

**Ordering Information**

**C-13-DFB2.5-XX-SXXXX/XXX-X-XX**

Wavelength  
13=1310 nm

Package  
T=TOSA  
R=Receptacle  
P=Pigtail

Pin Assignment  
Blank=A Type  
B=B Type  
D=D Type

Connector  
FC/ST/SC/MU/LC/Blank

Fiber Output Power  
L/M/H/2

I=Isolator  
Blank=No Isolator

Blank=PC Fiber  
APC=APC Fiber

Flange type (Blank;O;V;K)

RoHS Compliant  
Blank/G5/GR  
Blank = RoHS non-compliant product  
G5 = RoHS 5/6-compliant product (lead exemption)  
GR = Full RoHS compliant product (no exemption)

Packaging Dimensions (Units in mm)

Part Number: C-13-DFB2.5-RX-SXXXX-XX



FC Receptacle

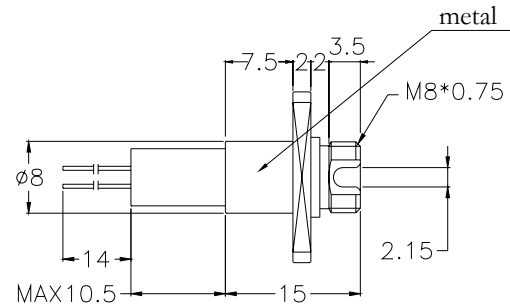

ST Receptacle

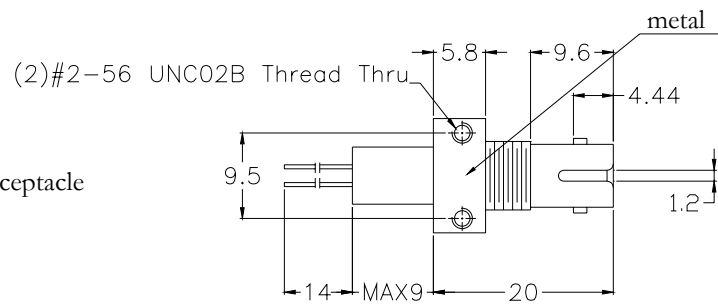

SC Receptacle



Packaging Dimensions (Units in mm)

Part Number: C-13-DFB2.5-TX-SSCXX-XX



SC TOSA (L&M Power)  
C-13-DFB2.5-TX-SSCXX-XX



SC TOSA (L&M Power with Isolator)  
C-13-DFB2.5-TX-SSCXI-XX



SC TOSA (H&2 Power)  
C-13-DFB2.5-TX-SSCXX-XX



Packaging Dimensions (Units in mm)

Part Number: C-13-DFB2.5-TX-SLCXX-XX



LC TOSA (L&M Power)  
C-13-DFB2.5-TX-SLCX-XX



LC TOSA (L&M Power)  
C-13-DFB2.5-TX-SLCXI-XX



LC TOSA (H&2 Power)  
C-13-DFB2.5-TX-SLCXX-XX

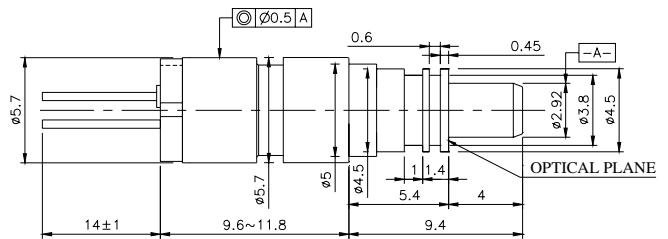

**Packaging Dimensions (Units in mm)**

**Part Number: C-13-DFB2.5-PX-SXXXX/XXX-X-XX**

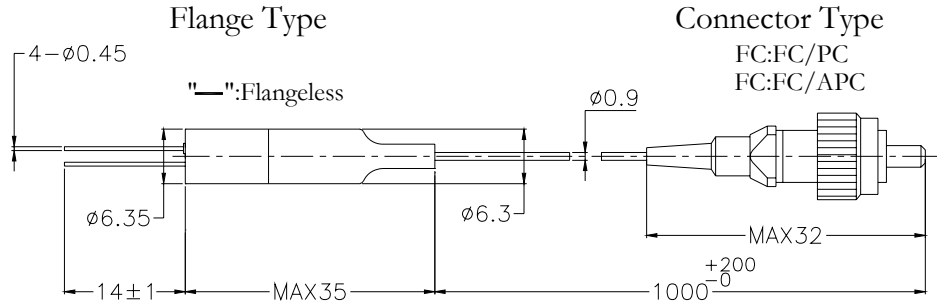
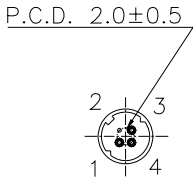

**Connector Type**  
 FC:FC/PC  
 FC:FC/APC

SC:SC/PC  
 SC:SC/APC

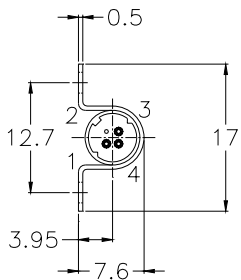

"O": Horizontal (Omega Housing)

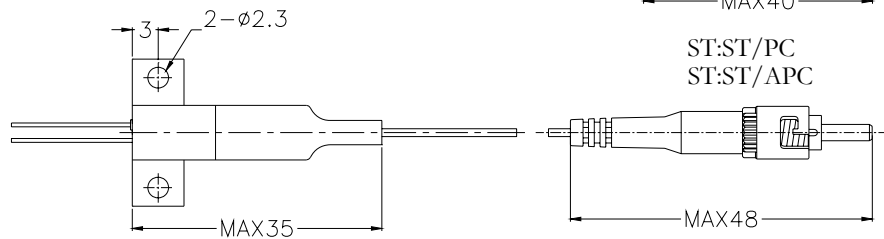

ST:ST/PC  
 ST:ST/APC

MU:MU Connector

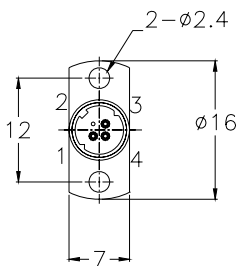
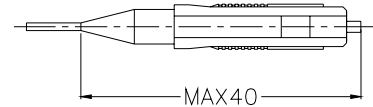

"V": Vertical

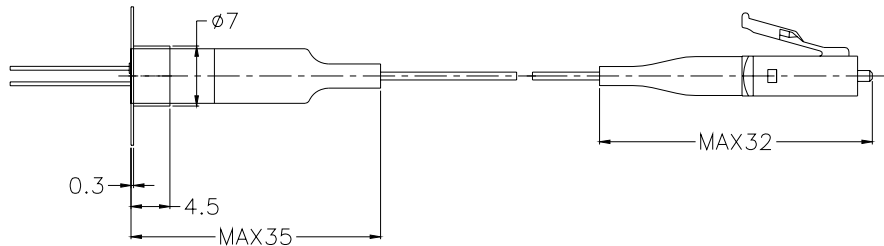

LC:LC/PC  
 LC:LC/APC

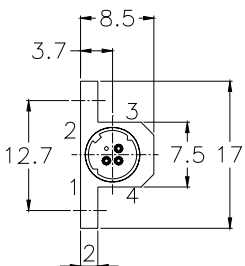

"K": Horizontal (KX Housing)

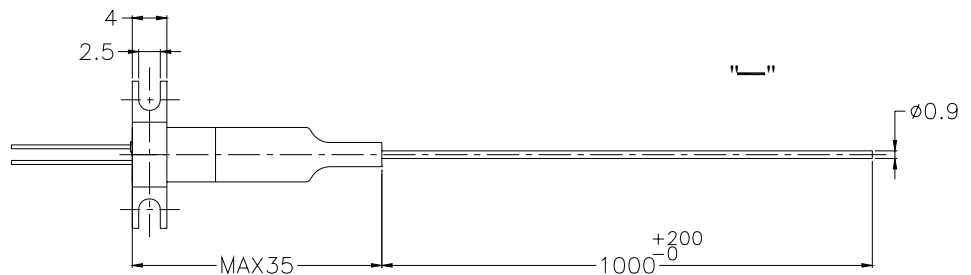

## Warnings

**Handling Precautions:** This device is susceptible to damage as a result of electrostatic discharge (ESD). A static free environment is highly recommended. Follow guidelines according to proper ESD procedures.

**Laser Safety:** Radiation emitted by laser devices can be dangerous to human eyes. Avoid eye exposure to direct or indirect radiation.

## Legal Notice

### **IMPORTANT NOTICE!**

All information contained in this document is subject to change without notice, at Source Photonics's sole and absolute discretion. Source Photonics warrants performance of its products to current specifications only in accordance with the company's standard one-year warranty; however, specifications designated as "preliminary" are given to describe components only, and Source Photonics expressly disclaims any and all warranties for said products, including express, implied, and statutory warranties, warranties of merchantability, fitness for a particular purpose, and non-infringement of proprietary rights. Please refer to the company's Terms and Conditions of Sale for further warranty information.

Source Photonics assumes no liability for applications assistance, customer product design, software performance, or infringement of patents, services, or intellectual property described herein. No license, either express or implied, is granted under any patent right, copyright, or intellectual property right, and Source Photonics makes no representations or warranties that the product(s) described herein are free from patent, copyright, or intellectual property rights. Products described in this document are NOT intended for use in implantation or other life support applications where malfunction may result in injury or death to persons. Source Photonics customers using or selling products for use in such applications do so at their own risk and agree to fully defend and indemnify Source Photonics for any damages resulting from such use or sale.

THE INFORMATION CONTAINED IN THIS DOCUMENT IS PROVIDED ON AN "AS IS" BASIS. Customer agrees that Source Photonics is not liable for any actual, consequential, exemplary, or other damages arising directly or indirectly from any use of the information contained in this document. Customer must contact Source Photonics to obtain the latest version of this publication to verify, before placing any order, that the information contained herein is current.

© Copyright Source Photonics, Inc. 2010

All rights reserved