

## IH5005 — IH5007 2-Channel Drivers with SPST FET Switches Gate Available AND

### FEATURES

- Gate Lead Available for Nulling Charge Injection Voltage
- Expansion Capability Available
- Each Channel Complete—Interfaces With Most Integrated Logic
- Low OFF power dissipation, 1 mW
- Low  $r_{DS(ON)}$ , 10 $\Omega$  Max on IH5005

### GENERAL DESCRIPTION

These switching circuits contain two channels in one package, each channel consisting of a driver circuit controlling a SPST junction FET switch. The driver interfaces DTL, TTL, or RTL logic signals for multiplexing, commutating, and D/A converter applications, which permits logic design

directly with the switch function. Logic "1" at the input turns the FET switch ON, and Logic "0" turns it OFF. The gate lead of the FETs has been brought out to enable the application of a refrerr resistor for nulling offset voltage due to charge injection. Driver points are brought out to provide for the addition of external FETs for expansion capability.

### PIN CONFIGURATIONS

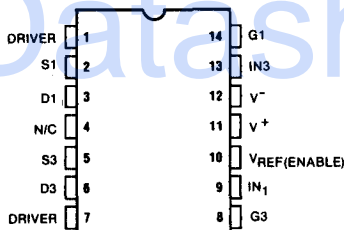

OUTLINE DWG  
DD, PD, JD

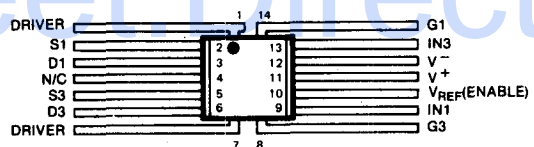

OUTLINE DWG  
FD-2

### SCHEMATIC AND LOGIC DIAGRAMS

IH5005 ( $r_{DS(on)} = 10\Omega$ )  
IH5006 ( $r_{DS(on)} = 30\Omega$ )  
IH5007 ( $r_{DS(on)} = 80\Omega$ )

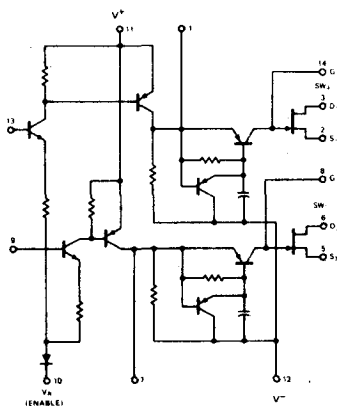

### ORDERING INFORMATION

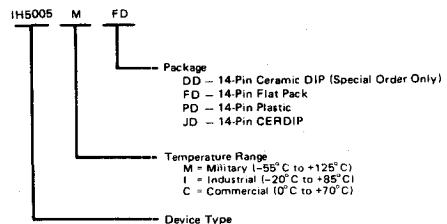

NOTE: Military temperature range not available in plastic package.

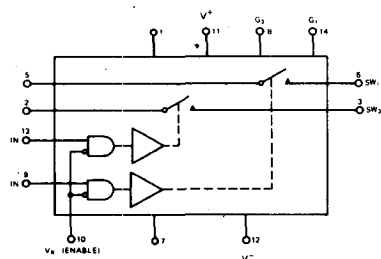

**ABSOLUTE MAXIMUM RATINGS**

Analog Signal Voltage ( $V_A - V^-$ or $V^+ - V_A$ )	30V
Total Supply Voltage ( $V^+ - V^-$ )	36V
Pos. Supply Voltage to Ref. Voltage ( $V^+ - V_R$ )	25V
Ref. Voltage to Neg. Supply Voltage ( $V_R - V^-$ )	22V
Power Dissipation (Note)	750 mW
Current (Any Terminal)	30 mA
Storage Temperature	-65°C to +150°C
Operating Temperature	-65°C to +125°C
Lead Temperature (soldering, 10 sec.)	300°C

NOTE: Dissipation rating assumes device is mounted with all leads welded or soldered to printed circuit board in ambient temperature below 70°C. For higher temperature, derate at rate of 10 mW/°C.

Stresses above those listed under Absolute Maximum Ratings may cause permanent damage to the device. These are stress ratings only, and functional operation of the device at these or any other conditions above those indicated in the operational sections of the specifications is not implied. Exposure to absolute maximum rating conditions for extended periods may affect device reliability.

**ELECTRICAL CHARACTERISTICS**

Applied Voltages for all tests  $V^+ = +12V$ ,  $V^- = -18V$ ,  $V_R = 0$ . Input test condition which guarantees FET switch ON or OFF as specified is used for output and power supply specifications.

3

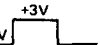
	SYMBOL (NOTE)	CHARACTERISTIC	TYPE	ABSOLUTE MAX. LIMIT			UNITS	TEST CONDITIONS	
				-55°	25°	125°			
INPUT	$V_{IN(ON)}$	Input Voltage—ON	All Circuits	2.9 min	2.5 min	2.0 min	Volts	$V^- = -12V$	
	$V_{IN(OFF)}$	Input Voltage—OFF		1.4	1.0	0.6	Volts	$V^- = -12V$	
	$I_{IN(ON)}$	Input Current		120	60	60	$\mu A$	$V_{IN} = 2.5V$	
	$I_{IN(OFF)}$	Input Leakage Current		0.1	0.1	2	$\mu A$	$V_{IN} = 0.8V$	
SWITCH OUTPUT	$r_{DS(ON)}$	Drain-Source On Resistance	IH5007	80	80	150	$\Omega$	$V_D = 10V, I_S = 1 mA$	
			IH5006	30	30	50	$\Omega$		
			IH5005	10	10	20	$\Omega$		
		$I_{D(ON)} + I_{S(ON)}$	Drive Leakage Current		2	100	nA	$V_D = V_S = -10V$	
		$I_{S(OFF)}$	Source Leakage Current		1	100	nA	$V_S = 10V, V_D = -10V$	
		$I_{D(OFF)}$	Drain Leakage Current		1	100	nA	$V_D = 10V, V_S = -10V$	
		$I_{D(ON)} + I_{S(ON)}$	Drive Leakage Current	IH5005	2	100	nA	$V_D = V_S = -10V$	
POWER SUPPLY	$I_{S(OFF)}$	Source Leakage Current		10	1000	nA	$V_S = 10V, V_D = -10V$		
	$I_{D(OFF)}$	Drain Leakage Current		10	1000	nA	$V_D = 10V, V_S = -10V$		
	$I^+$	Positive Power Supply Drain Current	All Circuits		3		mA	One Driver ON, $V_{IN} = 2.5V$	
	$I^-$	Negative Power Supply Drain Current			-1.8		mA		
	$I_{REF}$	Reference Power Supply Drain Current			-1.4		mA		
	$I^+_{LK}$	Positive Power Supply Leakage Current				25	$\mu A$	Both Drivers OFF, $V_{IN} = 0.8V$	
$I^-_{LK}$	Negative Power Supply Leakage Current				-25	$\mu A$			
$I_{RLK}$	Reference Power Supply Leakage Current				-25	$\mu A$			
SWITCHING	$t_{on}$	Turn-ON Time	IH5005		1.0	1.5	$\mu s$	See Page 3	
	$t_{off}$	Turn-OFF Time			2.5	3.7	$\mu s$		
	$t_{on}$	Turn-ON Time		IH5006		0.5	0.8		$\mu s$
	$t_{off}$	Turn-OFF Time		IH5007		1.0	1.5		$\mu s$
POWER	$P_{ON}$	ON Driver Power	All Circuits		175		mW	Both Inputs $V_{IN} = 2.5$	
	$P_{OFF}$	OFF Driver Power			1		mW	Both Inputs $V_{IN} = 1.0$	
FET	$V_{GSSF}$	Gate Source Forward Voltage	All Circuits		1.5		Volts	$I_G = 1.0 mA, V_{DS} = 0$	
EXPAND	$V_{PP}$	Peak-Peak Voltage at Expansion Outputs	All Circuits		30		Volts	$V_{IN} = 0V$  $V^+ = +18V, V^- = -18V, R_L \geq 10\Omega$	

NOTE: (OFF) and (ON) subscript notation refers to the conduction state of the FET switch for the given test.

SWITCHING TIMES (at 25°C)

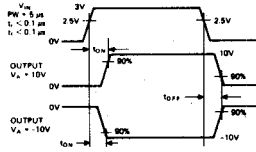

OFF MODEL

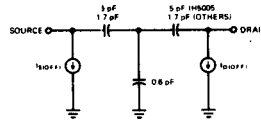

ON MODEL

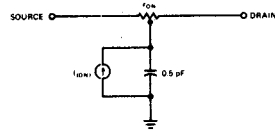

3

TYPICAL CHARACTERISTICS (per channel)

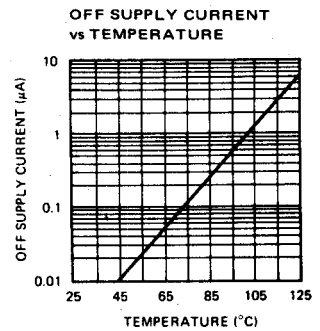
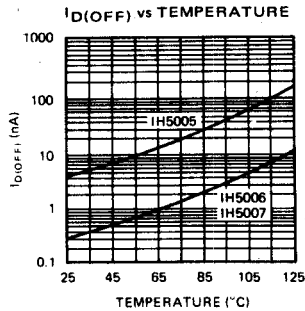
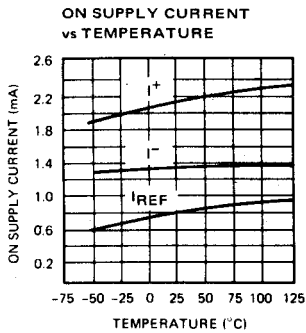
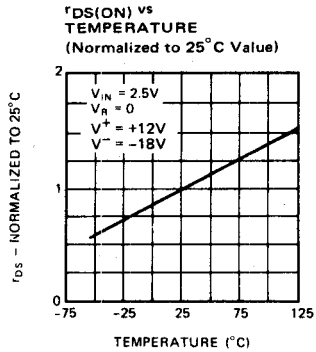
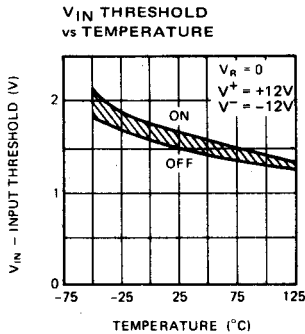

APPLICATION

Expansion Capability IH5005

3

