

LM101A, LM201A, LM301A HIGH-PERFORMANCE OPERATIONAL AMPLIFIERS

D961, OCTOBER 1979—REVISED JUNE 1988

- Low Input Currents
- Low Input Offset Parameters
- Frequency and Transient Response Characteristics Adjustable
- Short-Circuit Protection
- Offset-Voltage Null Capability
- No Latch-Up
- Wide Common-Mode and Differential Voltage Ranges
- Same Pin Assignments as uA709
- Designed to be Interchangeable with National Semiconductor LM101A and LM301A

description

The LM101A, LM201A, and LM301A are high-performance operational amplifiers featuring very low input bias current and input offset voltage and current to improve the accuracy of high-impedance circuits using these devices. The high common-mode input voltage range and the absence of latch-up make these amplifiers ideal for voltage-follower applications. The devices are protected to withstand short circuits at the output. The external compensation of these amplifiers allows the changing of the frequency response (when the closed-loop gain is greater than unity) for applications requiring wider bandwidth or higher slew rate. A potentiometer may be connected between the offset-null inputs (N1 and N2), as shown in Figure 7, to null out the offset voltage.

The LM101A is characterized for operation over the full military temperature range of -55°C to 125°C , the LM201A is characterized for operation from -25°C to 85°C , and the LM301A is characterized for operation from 0°C to 70°C .

symbol

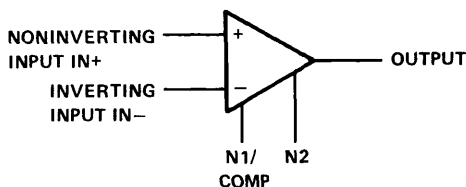

D, JG, OR P PACKAGE
(TOP VIEW)

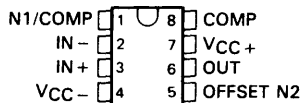

LM101A
W FLAT PACKAGE
(TOP VIEW)

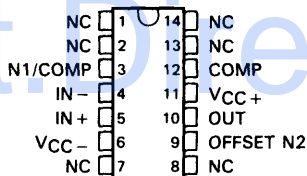

LM101A
U FLAT PACKAGE
(TOP VIEW)

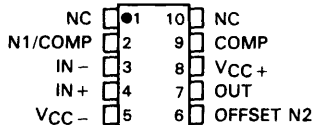

LM101A
FK CHIP-CARRIER PACKAGE
(TOP VIEW)

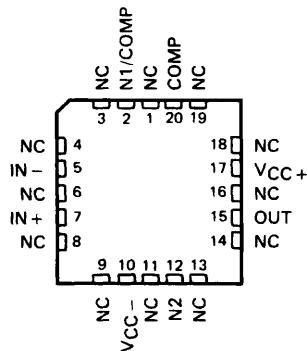

NC—No internal connection

LM101A, LM201A, LM301A HIGH-PERFORMANCE OPERATIONAL AMPLIFIERS

AVAILABLE OPTIONS

T _A	V _{IO} MAX at 25°C	PACKAGE					
		SMALL OUTLINE (D)	CHIP CARRIER (FK)	CERAMIC DIP (JG)	PLASTIC DIP (P)	FLAT PACK (U)	FLAT PACK (W)
0°C to 70°C	7.5 mV	LM301AD	—	LM301AJG	LM301AP	—	—
–25°C to 85°C	2 mV	LM201AD	—	LM201AJG	LM201AP	—	—
–55°C to 125°C	2 mV	—	LM101AFK	LM101AJG	—	LM101AU	LM101AW

The D package is available taped and reeled. Add the suffix R to the device type. (i.e., LM301ADR)

2

Operational Amplifiers

absolute maximum ratings over operating free-air temperature range (unless otherwise noted)

	LM101A	LM201A	LM301A	UNIT	
Supply voltage V _{CC+} (see Note 1)	22	22	18	V	
Supply voltage V _{CC–} (see Note 1)	–22	–22	–18	V	
Differential input voltage (see Note 2)	±30	±30	±30	V	
Input voltage (either input, see Notes 1 and 3)	±15	±15	±15	V	
Voltage between either offset null terminal (N1/N2) and V _{CC–}	–0.5 to 2	–0.5 to 2	–0.5 to 2	V	
Duration of output short-circuit (see Note 4)	unlimited	unlimited	unlimited		
Continuous total power dissipation	See Dissipation Rating Table				
Operating free-air temperature range	–55 to 125	–25 to 85	0 to 70	°C	
Storage temperature range	–65 to 150	–65 to 150	–65 to 150	°C	
Case temperature for 60 seconds: FK package	260			°C	
Lead temperature 1.6 mm (1/16 inch) from case for 60 seconds	JG, U, or W package	300	300	300	°C
Lead temperature 1.6 mm (1/16 inch) from case for 10 seconds	D or P package		260	260	°C

- NOTES: 1. All voltage values, unless otherwise noted, are with respect to the midpoint between V_{CC+} and V_{CC–}.
 2. Differential voltages are at the noninverting input terminal with respect to the inverting input terminal.
 3. The magnitude of the input voltage must never exceed the magnitude of the supply voltage or 15 V, whichever is less.
 4. The output may be shorted to ground or either power supply. For the LM101A only, the unlimited duration of the short-circuit applies at (or below) 125°C case temperature or 75°C free-air temperature. For the LM201A only, the unlimited duration of the short-circuit applies at (or below) 85°C case temperature or 75°C free-air temperature.

DISSIPATION RATING TABLE

PACKAGE	T _A ≤ 25°C POWER RATING	DERATING FACTOR	DERATE ABOVE T _A	T _A = 70°C POWER RATING	T _A = 85°C POWER RATING	T _A = 125°C POWER RATING
D	500 mW	5.8 mW/°C	64°C	464 mW	377 mW	N/A
FK	500 mW	11.0 mW/°C	105°C	500 mW	500 mW	275 mW
JG (LM101A)	500 mW	8.4 mW/°C	90°C	500 mW	500 mW	210 mW
JG (LM201A, LM301A)	500 mW	6.6 mW/°C	74°C	500 mW	429 mW	N/A
P	500 mW	N/A	N/A	500 mW	500 mW	N/A
U	500 mW	5.4 mW/°C	57°C	432 mW	351 mW	135 mW
W	500 mW	8.0 mW/°C	87°C	500 mW	500 mW	200 mW

LM101A, LM201A, LM301A HIGH-PERFORMANCE OPERATIONAL AMPLIFIERS

electrical characteristics at specified free-air temperature, $C_C = 30$ pF (see Note 5)

PARAMETER	TEST CONDITIONS†	LM101A, LM201A			LM301A			UNIT
		MIN	TYP	MAX	MIN	TYP	MAX	
V_{IO} Input offset voltage	$V_O = 0$ V	25°C	0.6	2	2	7.5	mV	
		Full range				10		
α_{VIO} Average temperature coefficient of input offset voltage	$V_O = 0$ V	Full range	3	15	6	30	$\mu\text{V}/^\circ\text{C}$	
I_{IO} Input offset current		25°C	1.5	10	3	50	nA	
		Full range		20		70		
α_{IIO} Average temperature coefficient of input offset current		$T_A = -55^\circ\text{C}$ to 25°C	0.02	0.2			nA/ $^\circ\text{C}$	
		$T_A = 25^\circ\text{C}$ to MAX	0.01	0.1				
		$T_A = 0^\circ\text{C}$ to 25°C			0.02	0.6		
		$T_A = 25^\circ\text{C}$ to 70°C			0.01	0.3		
I_{IB} Input bias current		25°C	30	75	70	250	nA	
		Full range		100		300		
V_{ICR} Common-mode input voltage range	See Note 6	Full range	± 15		± 12		V	
V_{OPP} Maximum peak-to-peak output voltage swing	$V_{CC\pm} = \pm 15$ V, $R_L = 10$ k Ω	25°C	24	28	24	28	V	
		Full range	24		24			
		25°C	20	26	20	26		
		Full range	20		20			
A_{VD} Large-signal differential voltage amplification	$V_{CC\pm} = \pm 15$ V, $V_O = \pm 10$ V, $R_L \geq 2$ k Ω	25°C	50	200	25	200	V/mV	
		Full range	25		15			
r_i Input resistance		25°C	1.5	4	0.5	2	M Ω	
CMRR Common-mode rejection ratio	$V_{IC} = V_{ICR}$ min	25°C	80	98	70	90	dB	
		Full range	80		70			
k_{SVR} Supply voltage rejection ratio ($\Delta V_{CC}/\Delta V_{IO}$)		25°C	80	98	70	96	dB	
		Full range	80		70			
I_{CC} Supply current	No load, $V_O = 0$, See Note 6	25°C	1.8	3	1.8	3	mA	
		MAX	1.2	2.5				

† All characteristics are measured under open-loop conditions with zero common-mode input voltage unless otherwise specified. Full range for LM101A is -55°C to 125°C , for LM201A is -25°C to 85°C , and for LM301A is 0°C to 70°C .

NOTES: 5. Unless otherwise noted, $V_{CC\pm} = \pm 5$ V to ± 20 V for LM101A and LM201A, and $V_{CC\pm} = \pm 5$ V to ± 15 V for LM301A. All typical values are at $V_{CC\pm} = \pm 15$ V.

6. For LM101A and LM201A, $V_{CC\pm} = \pm 20$ V. For LM301A, $V_{CC\pm} = \pm 15$ V.

2

Operational Amplifiers

LM101A, LM201A, LM301A HIGH-PERFORMANCE OPERATIONAL AMPLIFIERS

2 Operational Amplifiers

TYPICAL CHARACTERISTICS

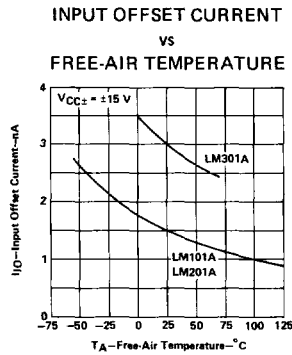

FIGURE 1

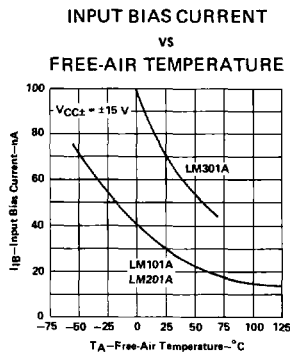

FIGURE 2

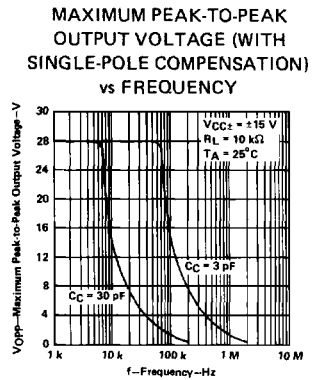

FIGURE 3

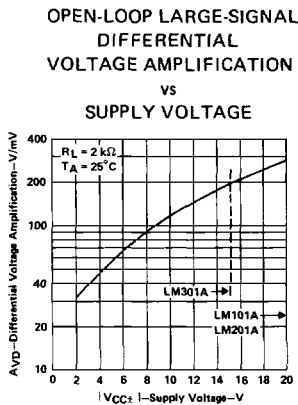

FIGURE 4

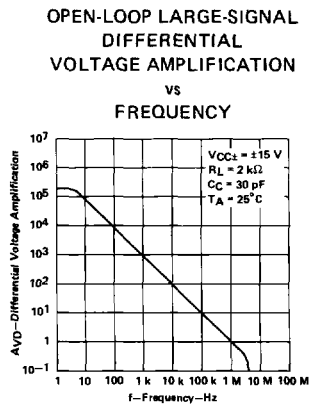

FIGURE 5

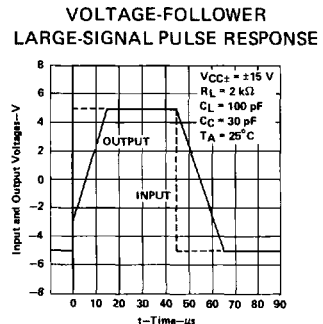

FIGURE 6

TYPICAL APPLICATION DATA

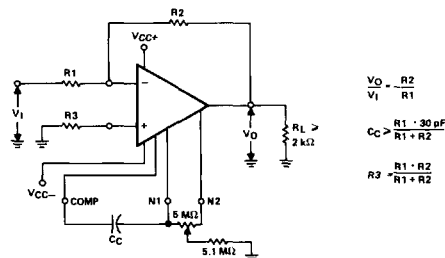

FIGURE 7. INVERTING CIRCUIT WITH ADJUSTABLE GAIN,
SINGLE-POLE COMPENSATION, AND OFFSET ADJUSTMENT