

Features

- Ideally Suited for Automatic Insertion
- Epitaxial Planar Die Construction
- For Switching, AF Driver and Amplifier Applications
- Complementary NPN Types Available (BC817)
- Also Available in Lead Free Version

Mechanical Data

- Case: SOT-23, Molded Plastic
- Case material - UL Flammability Rating Classification 94V-0
- Moisture sensitivity: Level 1 per J-STD-020A
- Terminals: Solderable per MIL-STD-202, Method 208
- Also Available in Lead Free Plating (Matte Tin Finish). Please see Ordering Information, Note 4, on Page 3
- Pin Connections: See Diagram
- Marking (See Page 3): BC807-16 5A, K5A
BC807-25 5B, K5B
BC807-40 5C, K5C
- Ordering & Date Code Information: See Page 3
- Approx. Weight: 0.008 grams

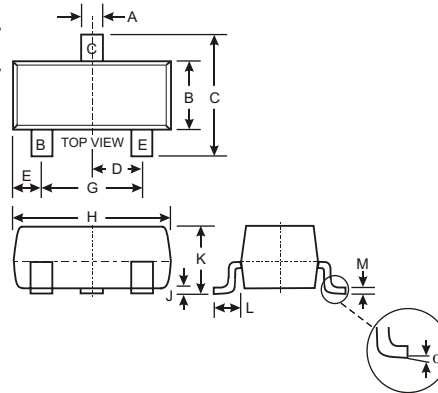

SOT-23		
Dim	Min	Max
A	0.37	0.51
B	1.20	1.40
C	2.30	2.50
D	0.89	1.03
E	0.45	0.60
G	1.78	2.05
H	2.80	3.00
J	0.013	0.10
K	0.903	1.10
L	0.45	0.61
M	0.85	0.80
α	0°	8°
All Dimensions in mm		

Maximum Ratings @ $T_A = 25^\circ\text{C}$ unless otherwise specified

Characteristic	Symbol	Value	Unit
Collector-Emitter Voltage	V_{CEO}	-45	V
Emitter-Base Voltage	V_{EBO}	-5.0	V
Collector Current	I_C	-500	mA
Peak Collector Current	I_{CM}	-1000	mA
Peak Emitter Current	I_{EM}	-1000	mA
Power Dissipation at $T_{SB} = 50^\circ\text{C}$ (Note 1)	P_d	310	mW
Thermal Resistance, Junction to Substrate Backside (Note 1)	$R_{\theta JSB}$	320	$^\circ\text{C}/\text{W}$
Thermal Resistance, Junction to Ambient Air (Note 1)	$R_{\theta JA}$	403	$^\circ\text{C}/\text{W}$
Operating and Storage Temperature Range	T_j, T_{STG}	-65 to +150	$^\circ\text{C}$

Electrical Characteristics @ $T_A = 25^\circ\text{C}$ unless otherwise specified

Characteristic (Note 2)	Symbol	Min	Typ	Max	Unit	Test Condition
DC Current Gain Current Gain Group -16 -25 -40	h_{FE}	100		250		$V_{CE} = 1.0\text{V}, I_C = 100\text{mA}$
		160		400		
		250		600		
		60	—	—	—	
Current Gain Group -16 -25 -40	h_{FE}	100		—		$V_{CE} = 1.0\text{V}, I_C = 300\text{mA}$
		100		—		
		170		—		
Collector-Emitter Saturation Voltage	$V_{CE(SAT)}$	—	—	-0.7	V	$I_C = 500\text{mA}, I_B = 50\text{mA}$
Base-Emitter Voltage	V_{BE}	—	—	-1.2	V	$V_{CE} = 1.0\text{V}, I_C = 300\text{mA}$
Collector-Emitter Cutoff Current	I_{CES}	—	—	-100 -5.0	nA μA	$V_{CE} = 45\text{V}$ $V_{CE} = 25\text{V}, T_j = 150^\circ\text{C}$
Emitter-Base Cutoff Current	I_{EBO}	—	—	-100	nA	$V_{EB} = 4.0\text{V}$
Gain Bandwidth Product	f_T	100	—	—	MHz	$V_{CE} = 5.0\text{V}, I_C = 10\text{mA}, f = 50\text{MHz}$
Collector-Base Capacitance	C_{CBO}	—	—	12	pF	$V_{CB} = 10\text{V}, f = 1.0\text{MHz}$

Notes: 1. Device mounted on ceramic substrate 0.7mm; 2.5cm² area.
2. Short duration pulse test used to minimize self-heating effect.

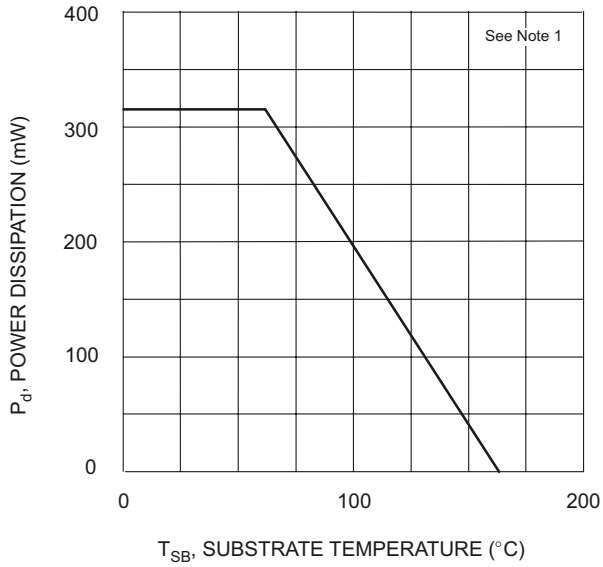

Fig. 1, Power Derating Curve

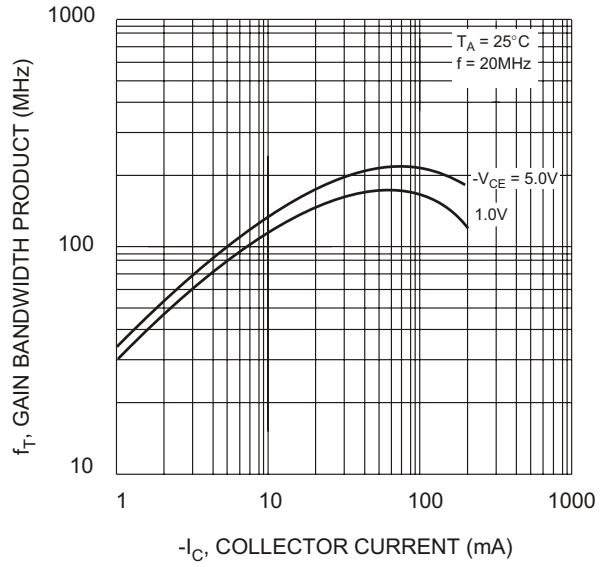

Fig. 2, Gain-Bandwidth Product vs. Collector Current

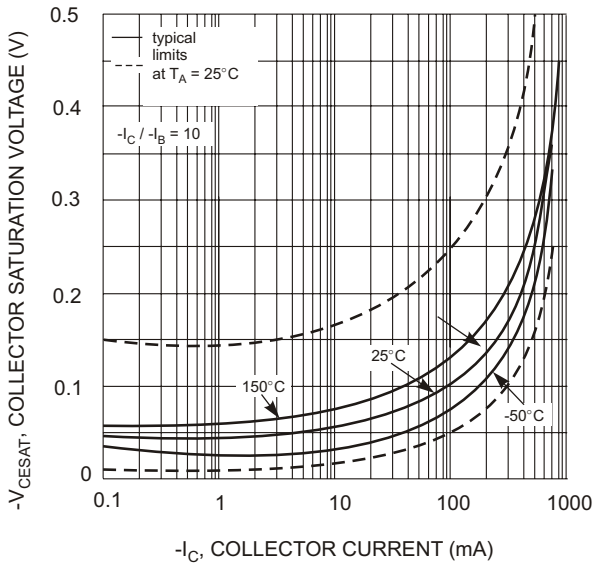

Fig. 3, Collector Sat. Voltage vs. Collector Current

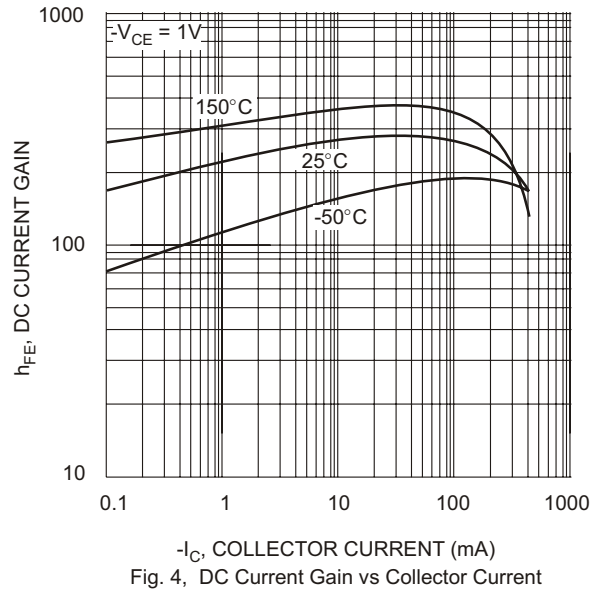

Fig. 4, DC Current Gain vs. Collector Current

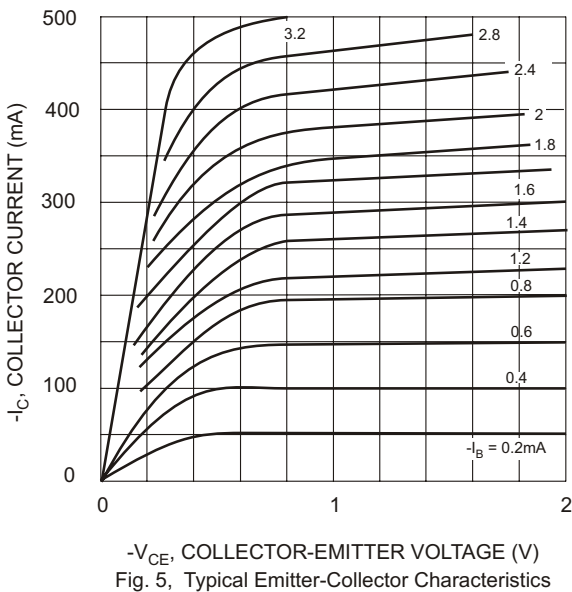

Fig. 5, Typical Emitter-Collector Characteristics

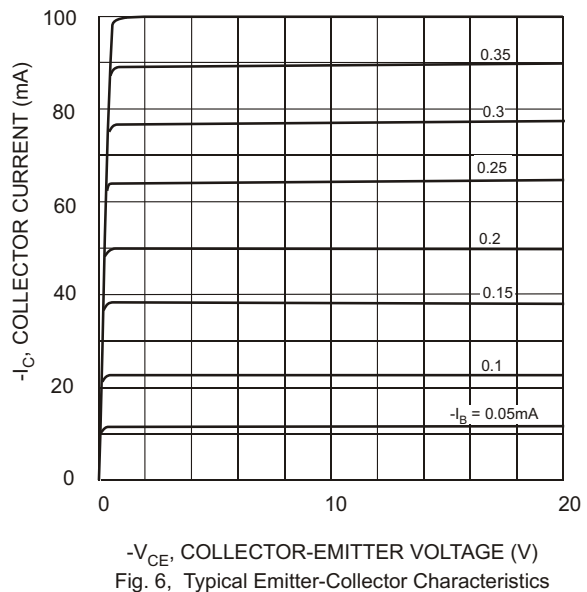

Fig. 6, Typical Emitter-Collector Characteristics

Ordering Information

Device*	Packaging	Shipping
BC807-xx-7	SOT-23	3000/Tape & Reel

- Notes:
- For Packaging Details, go to our website at <http://www.diodes.com/datasheets/ap02007.pdf>.
*xx = gain group, eg. BC807-16-7.
 - For Lead Free version (with Lead Free terminal finish) part number, please add "-F" suffix to part number above.
Example: BC807-16-7-F.

Marking Information

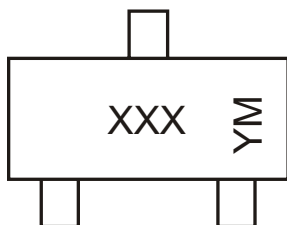

XXX = Product Type Marking Code (See Page 1): e.g. K5A = BC807-16
 YM = Date Code Marking
 Y = Year ex: N = 2002
 M = Month ex: 9 = September

Date Code Key

Year	1998	1999	2000	2001	2002	2003	2004
Code	J	K	L	M	N	P	R

Month	Jan	Feb	March	Apr	May	Jun	Jul	Aug	Sep	Oct	Nov	Dec
Code	1	2	3	4	5	6	7	8	9	O	N	D