

Standard Density Plug Inserts

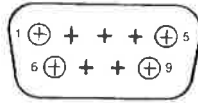

Shell Size E
(9 Position)



Shell Size A
(15 Position)

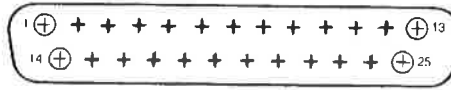

Shell Size B
(25 Position)

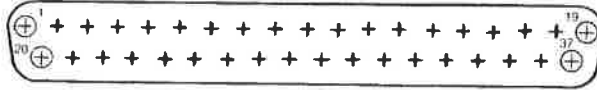

Shell Size C
(37 Position)

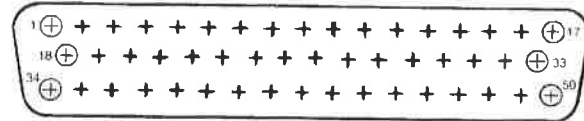

Shell Size D
(50 Position)

Datasheet.Directory

NOTE: Mating face of plug is shown; socket is mirror image.

Panel Mounting Specifications

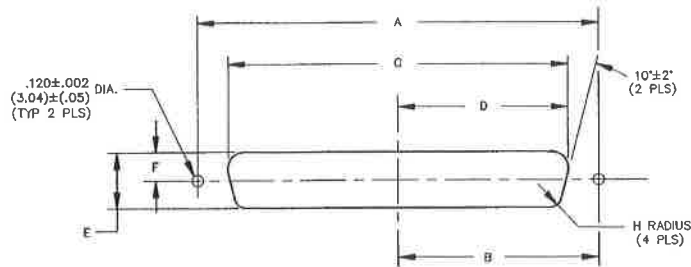

Dimensions

Shell Size	Positions	Mounting Method		A		B		C		D		E		F		H		
		Front/Rear Panel	in	mm	in	mm	in	mm	in	mm	in	mm	in	mm	in	mm		
E	9	Front	0.98	24.89	0.49	12.45	0.87	22.10	0.44	11.18	0.51	12.95	0.26	6.60	0.08	2.03		
		Rear	0.98	24.89	0.49	12.45	0.81	20.57	0.40	10.16	0.45	11.43	0.23	5.84	0.13	3.30		
A	15	Front	1.31	33.27	0.66	16.76	1.10	27.94	0.60	15.24	0.51	12.95	0.26	6.60	0.08	2.03		
		Rear	1.31	33.27	0.66	16.76	1.13	28.70	0.57	14.48	0.45	11.43	0.23	5.84	0.13	3.30		
B	25	Front	1.85	46.99	0.93	23.62	1.74	44.20	0.87	22.10	0.51	12.95	0.26	6.60	0.08	2.03		
		Rear	1.85	46.99	0.93	23.62	1.67	42.42	0.84	21.34	0.45	11.43	0.23	5.84	0.13	3.30		
C	37	Front	2.50	63.50	1.25	31.75	2.39	60.71	1.20	30.48	0.51	12.95	0.26	6.60	0.08	2.03		
		Rear	2.50	63.50	1.25	31.75	2.33	59.18	1.16	29.46	0.45	11.43	0.23	5.84	0.13	3.30		
D	50	Front	2.41	61.21	1.20	30.48	2.30	58.42	1.15	29.21	0.62	15.75	0.31	6.60	0.08	2.03		
		Rear	2.41	61.21	1.20	30.48	2.22	56.39	1.11	28.19	0.56	14.22	0.28	5.84	0.13	3.30		

4

PANEL MOUNTING HARDWARE: Aids in alignment of plug and receptacle.

Float Bushing

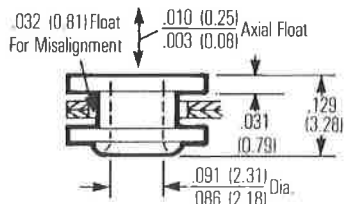

Rear panel mounting

Reverse Float Bushing

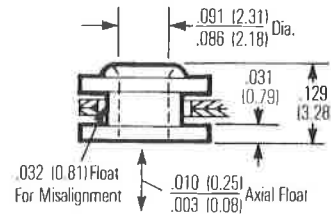

Front panel mounting

Floating Dual Bushing

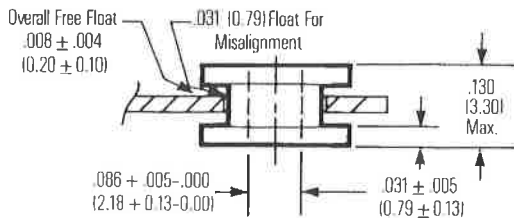

Front and rear panel mounting

4-40 Clinch Nut

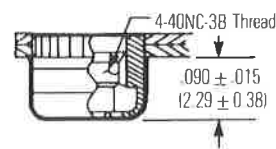

Rear panel mounting

D-subminiature Connectors Information

Introduction Shells and Mounts

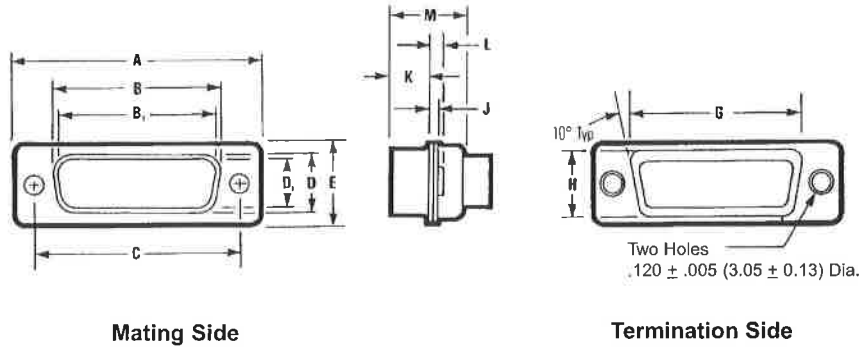

Mating Side

Termination Side

Shell Size	Positions	Connector Type	A ±.015" (0.38mm)		B ±.010" (0.25mm)		B ₁ ±.005" (0.13 mm)		C ±.005" (0.13mm)		D ±.010" (0.25mm)		D ₁ ±.010" (0.25mm)		E ±.010" (0.25mm)	
			in	mm	in	mm	in	mm	in	mm	in	mm	in	mm	in	mm
E	9	Plug	1.213	30.81	--	--	.666	16.90	0.984	24.99	--	--	.329	8.40	.494	12.55
		Socket	1.213	30.81	.640	16.26	--	--	0.984	24.99	.308	7.82	--	--	.494	12.55
A	15	Plug	1.541	39.14	--	--	.994	25.30	1.312	33.32	--	--	.329	8.40	.494	12.55
		Socket	1.541	39.14	.968	24.59	--	--	1.312	33.32	.308	7.82	--	--	.494	12.55
B	25	Plug	2.088	53.04	--	--	1.534	39.00	1.852	47.04	--	--	.329	8.40	.494	12.55
		Socket	2.088	53.04	1.508	38.30	--	--	1.852	47.04	.308	7.82	--	--	.494	12.55
C	37	Plug	2.729	69.32	--	--	2.182	55.40	2.500	63.50	--	--	.329	8.40	.494	12.55
		Socket	2.729	69.32	2.156	54.76	--	--	2.500	63.50	.308	7.82	--	--	.494	12.55
D	50	Plug	2.635	66.93	--	--	2.079	52.80	2.406	61.11	--	--	.436	11.07	.605	15.37
		Socket	2.635	66.93	2.062	52.34	--	--	2.406	61.11	.420	10.67	--	--	.605	15.37

Shell Size	Positions	Connector Type	G ±.010" (0.25mm)		H ±.010" (0.25mm)		J ±.010" (0.25 mm)		K ±.005" (0.25mm)		L ±.010" (0.25mm)		M ±.010" (0.25mm)	
			in	mm	in	mm	in	mm	in	mm	in	mm	in	mm
E	9	Plug	.759	19.28	.422	10.72	.030	0.76	.236	5.99	.045	1.14	.422	10.72
		Socket	.759	19.28	.422	10.72	.030	0.76	.243	6.17	.045	1.14	.429	10.92
A	15	Plug	1.083	27.51	.422	10.72	.030	0.76	.236	5.99	.045	1.14	.422	10.72
		Socket	1.083	27.51	.422	10.72	.030	0.76	.253	6.17	.045	1.14	.429	10.92
B	25	Plug	1.625	41.27	.422	10.72	.039	0.99	.231	5.87	.060	1.52	.426	10.82
		Socket	1.625	41.27	.422	10.72	.030	0.76	.243	6.17	.045	1.14	.429	10.92
C	37	Plug	2.272	57.71	.422	10.72	.039	0.99	.231	5.87	.060	1.52	.426	10.82
		Socket	2.272	57.71	.422	10.72	.030	0.76	.243	6.17	.045	1.14	.429	10.92
D	50	Plug	2.178	55.32	.534	13.56	.039	0.99	.231	5.87	.060	1.52	.426	10.82
		Socket	2.178	55.32	.534	13.56	.030	0.76	.243	6.17	.045	1.14	.429	10.92

B and D are outside dimensions for socket. D and B are inside dimensions for plug.

4

**Standard Density D-subminiature
Mounting Dimensions Board Layouts
Footprints (Component side shown)**

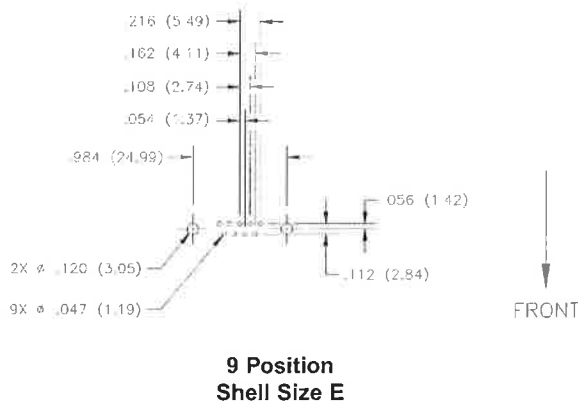

**9 Position
Shell Size E**

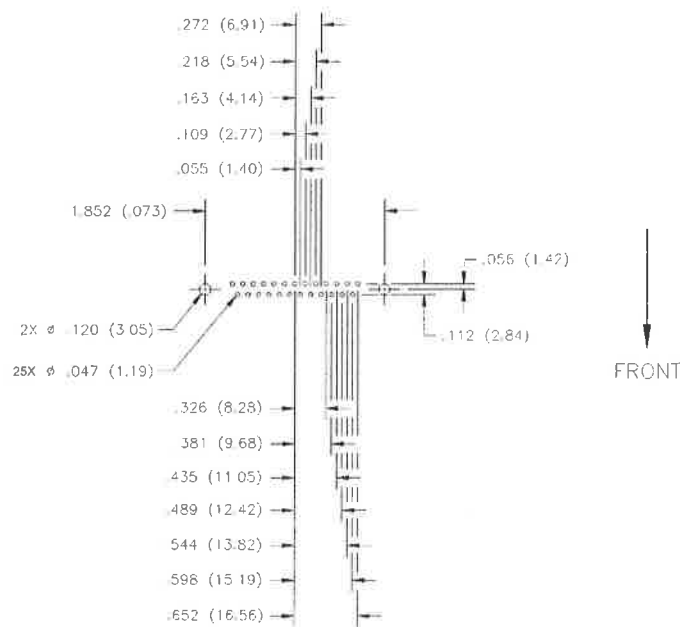

**25 Position
Shell Size B**

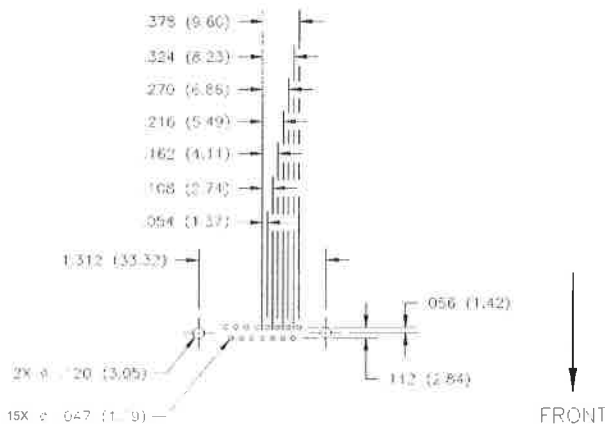

**15 Position
Shell Size A**

4

The footprints on this page are standard for all metal shell D-subminiature connectors.

On all right-angle D-subminiature connectors, the short row of contacts is positioned closest to the edge of the board.

PC Board Lead Hole Size

Terminal Dia.		Hole Dia.	
in	mm	in	mm
.040	1.02	.055	1.40
.030	0.76	.045	1.14
.024-.025	0.61-0.64	.039	0.99

**Standard Density D-subminiature
Mounting Dimensions Board Layouts
Footprints (Component side shown)**

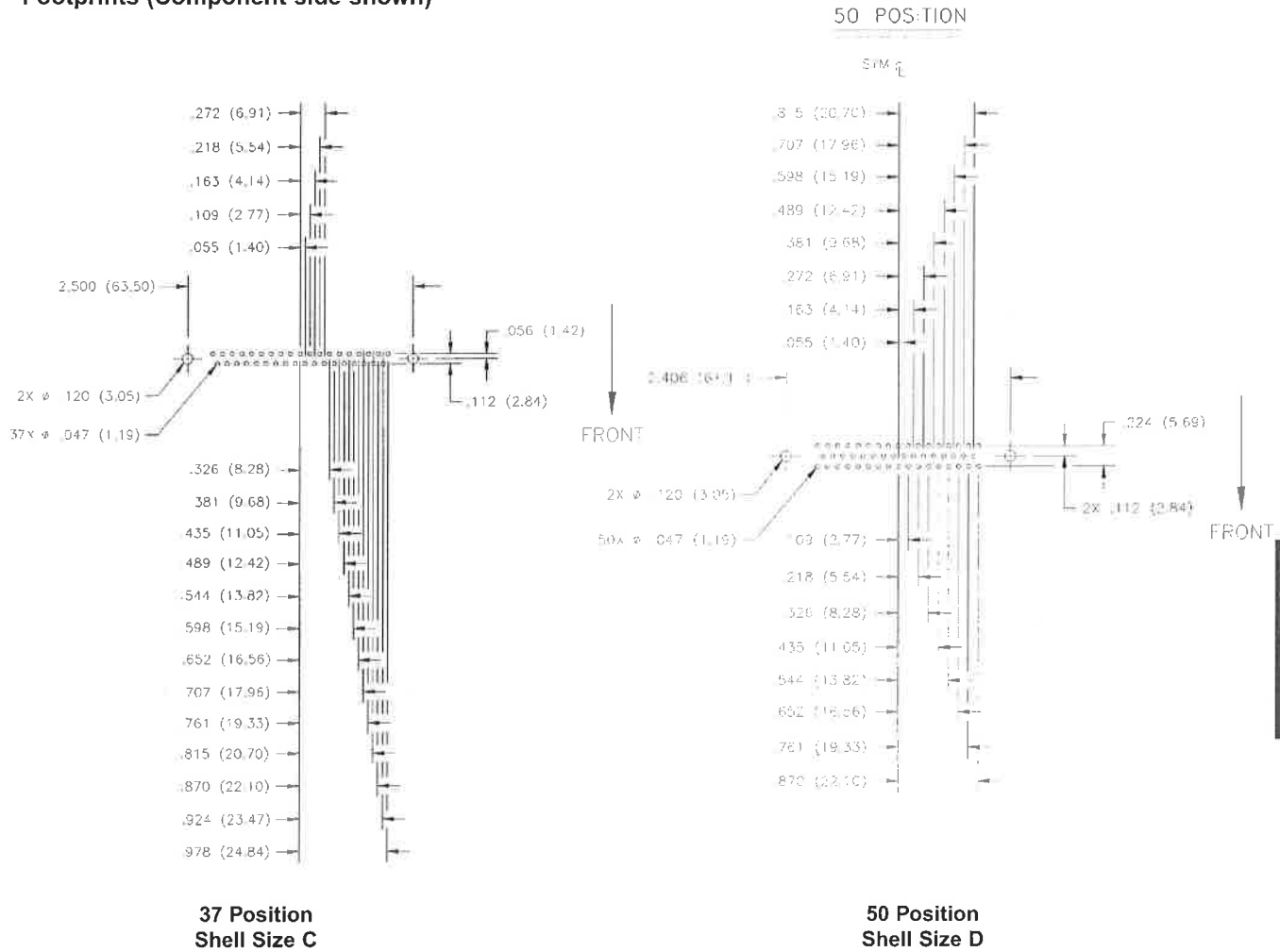

**37 Position
Shell Size C**

**50 Position
Shell Size D**

The footprints on this page are standard for all metal shell D-subminiature connectors.

On all right-angle D-subminiature connectors, the short row of contacts is positioned closest to the edge of the board.

PC Board Lead Hole Size

Terminal Dia.		Hole Dia.	
in	mm	in	mm
.040	1.02	.055	1.40
.030	0.76	.045	1.14
.024-.025	0.61-0.64	.039	0.99

Mouser Electronics

Authorized Distributor

Click to View Pricing, Inventory, Delivery & Lifecycle Information:

Cinch Connectivity Solutions:

[M24308/25-10F](#) [M24308/25-9F](#) [M24308/26-1F](#) [M24308/26-2F](#) [M24308/2-1Z](#) [M24308/2-3F](#) [M24308/2-4](#) [M24308/3-2F](#) [M24308/4-1F](#) [M24308/4-3F](#) [M24308/4-4F](#) [M24308/4-5F](#) [M24308/3-3Z](#) [M24308/1-1Z](#) [M24308/1-2Z](#) [M24308/2-4Z](#) [M24308/2-2F](#) [M24308/2-1F](#) [M24308/2-4F](#) [M24308/4-2F](#) [M24308/4-313F](#) [M24308/4-315F](#) [M24308/4-324Z](#) [M24308/4-326Z](#) [M24308/4-435F](#) [M24308/4-435Z](#) [M24308/4-437F](#) [M24308/4-439F](#) [M24308/4-448F](#) [M24308/4-457F](#) [M24308/4-6Z](#) [M24308/4-8Z](#) [M24308/4-9Z](#) [M24308/2-344F](#) [M24308/2-344Z](#) [M24308/2-345F](#) [M24308/2-346F](#) [M24308/2-346Z](#) [M24308/2-355F](#) [M24308/2-356F](#) [M24308/2-357F](#) [M24308/2-36F](#) [M24308/2-484Z](#) [M24308/2-486Z](#) [M24308/2-8Z](#) [M24308/3-14Z](#) [M24308/4-302Z](#) [M24308/4-305Z](#) [M24308/4-306Z](#) [M24308/1-12Z](#) [M24308/1-13Z](#) [M24308/1-15Z](#) [M24308/1-3Z](#) [M24308/1-4Z](#) [M24308/1-5Z](#) [M24308/2-23Z](#) [M24308/2-24Z](#) [M24308/2-281Z](#) [M24308/2-282Z](#) [M24308/2-2Z](#) [M24308/23-10Z](#) [M24308/23-11Z](#) [M24308/23-1Z](#) [M24308/2-342Z](#) [M24308/2-343Z](#) [M24308/23-4Z](#) [M24308/23-5Z](#) [M24308/23-7Z](#) [M24308/23-8Z](#) [M24308/23-9Z](#) [M24308/24-10Z](#) [M24308/24-11Z](#) [M24308/2-482F](#) [M24308/24-8Z](#) [M24308/24-9Z](#) [M24308/2-6Z](#) [M24308/3-13Z](#) [M24308/3-15Z](#) [M24308/3-17F](#) [M24308/3-18F](#) [M24308/3-19F](#) [M24308/3-1Z](#) [M24308/3-20Z](#) [M24308/3-21F](#) [M24308/3-2Z](#) [M24308/23-2Z](#) [M24308/23-3Z](#) [M24308/2-342F](#) [M24308/4-327F](#) [M24308/4-328F](#) [M24308/1-12F](#) [M24308/1-13F](#) [M24308/1-14F](#) [M24308/1-15F](#) [M24308/1-16F](#) [M24308/1-1F](#) [M24308/1-2F](#) [M24308/1-3F](#) [M24308/1-4F](#) [M24308/1-5F](#)