

**GPP TRANSIENT VOLTAGE SUPPRESSOR
600 WATT PEAK POWER 5.0 WATTS STEADY STATE**

FEATURES

- * Plastic package has underwriters laboratory
- * Glass passivated chip construction
- * 600 watt surge capability at 1ms
- * Excellent clamping capability
- * Low zener impedance
- * Fast response time



DO-15

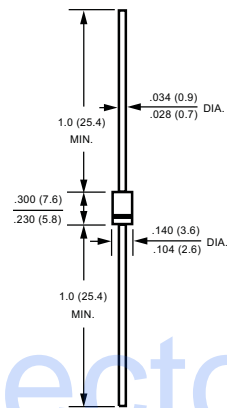

MAXIMUM RATINGS AND ELECTRICAL CHARACTERISTICS

Ratings at 25 °C ambient temperature unless otherwise specified.

Single phase, half wave, 60 Hz, resistive or inductive load.

For capacitive load, derate current by 20%.

MAXIMUM RATINGS (@ TA=25 °C unless otherwise noted)

RATINGS	SYMBOL	VALUE	UNITS
Peak Power Dissipation at TA = 25°C, TP = 1mS (Note 1)	PPPM	Minimum 600	W
Steady State Power Dissipation at TL = 75°C lead length, .375" (9.5 mm) (Note 2)	PM(AV)	5.0	W
Peak Forward Surge Current, 8.3mS Single half sine-wave superimposed on rated load (JEDEC METHODE) (Note 4)	IFSM	100	A
Typical Current Squared Time	I ² T	41.5	A ² S
Maximum instantaneous forwards voltage at 50A for unidirectional only (Note 5)	VF	3.5/5.0	V
Operating and Storage Temperature Range	TJ, TSTG	-55 to + 150	°C

- NOTES : 1. Non-repetitive current pulse, per Fig.3 and derated above TA = 25°C per Fig.2.
 2. Mounted on 0.2 X 0.2" (5.0 X 5.0mm) copper pad to each terminal.
 3. "Fully ROHS compliant", "100% Sn plating (Pb-free)".
 4. Measured on 8.3ms single half sine-wave or equivalent square wave duty cycle =4 pulses per minute maximum.
 5. VF =3.0V max. for devices of V(BR) ≤220V and VF =5.0Volts for device of V(BR) ≥220V.

2016-09
REV:B

RATING AND CHARACTERISTICS CURVES (P6KE6.8 THRU P6KE440CA)

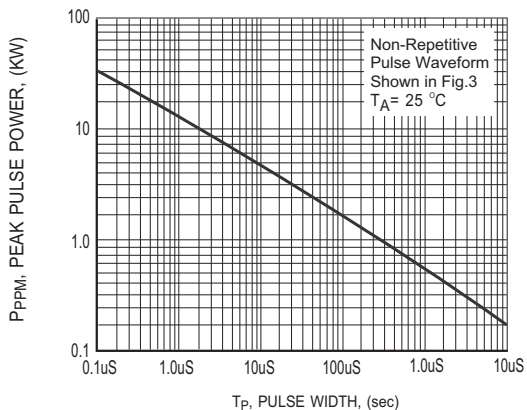

FIG.1 PEAK PULSE POWER RATING CURVE

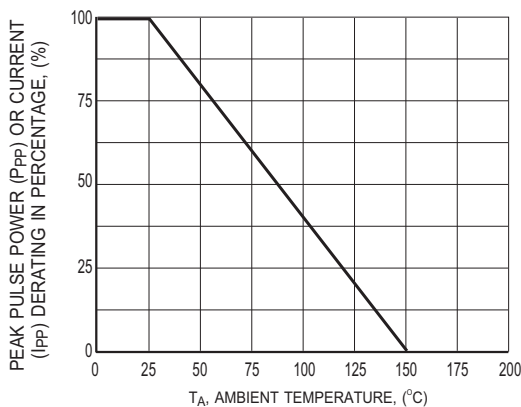

FIG.2 PULSE DERATING CURVE

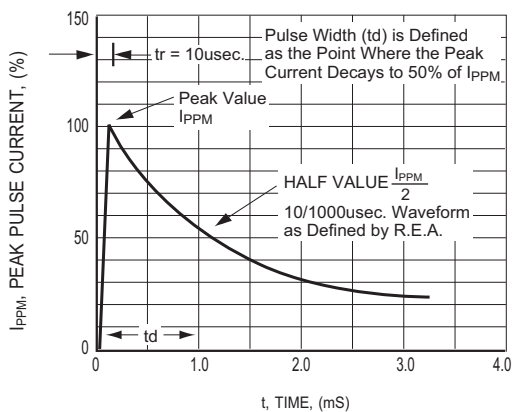

FIG.3 PULSE WAVEFORM

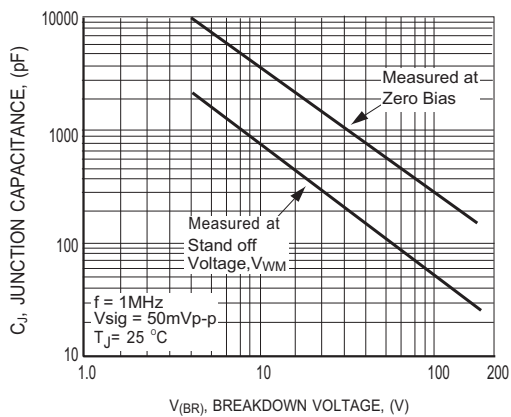

FIG.4 TYPICAL JUNCTION CAPACITANCE BIDIRECTIONAL

RATING AND CHARACTERISTICS CURVES (P6KE6.8 THRU P6KE440CA)

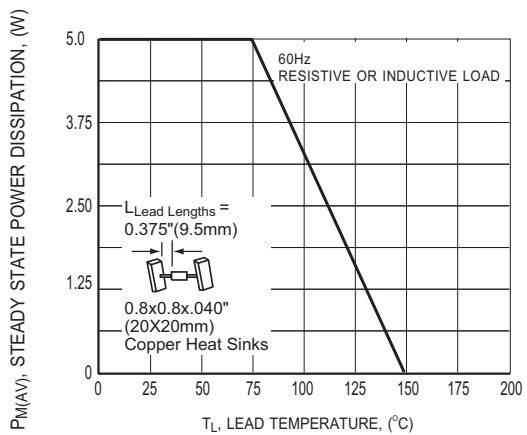

FIG.5 STEADY STATE POWER DERATING CURVE

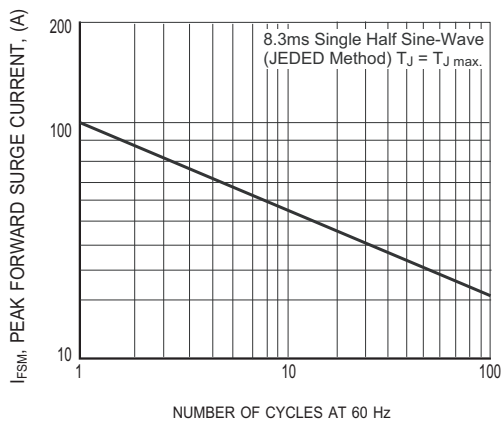

FIG.6 MAXIMUM NON-REPETITIVE FORWARD SURGE CURRENT UNIDIRECTIONAL

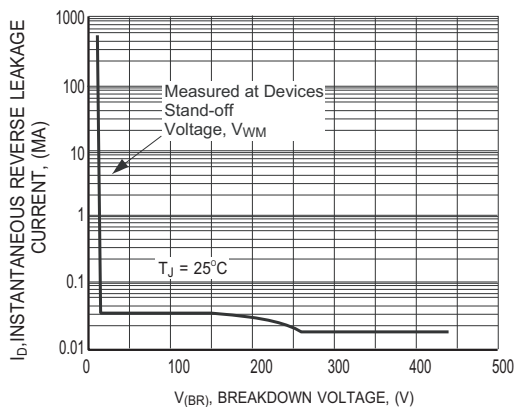

FIG.7 TYPICAL REVERSE LEAKAGE CHARACTERISTICS

TRANSIENT VOLTAGE SUPPRESSORS

600W SERIES TVS DIODES / DO-15 (CASE 8) 600W

TYPE	Breakdown Voltage			Reverse Stand off Voltage V_{WM} (Volts)	Maximum Reverse Leakage at V_{WM} I_D (μ A)	Maximum Peak Pulse Current I_{PPM} (Amps)	Maximum Clamping Voltage at I_{PPM} V_C (Volts)
	V_{BR} (Volts)		@ I_T (mA)				
	MIN.	MAX.					
P6KE6.8	6.12	7.48	10	5.50	1000	55.6	10.8
P6KE6.8A	6.45	7.14	10	5.80	1000	57.1	10.5
P6KE7.5	6.75	8.25	10	6.05	500	51.3	11.7
P6KE7.5A	7.13	7.88	10	6.40	500	53.1	11.3
P6KE8.2	7.38	9.02	10	6.63	200	48	12.5
P6KE8.2A	7.79	8.61	10	7.02	200	49.6	12.1
P6KE9.1	8.19	10.0	1.0	7.37	50	43.5	13.8
P6KE9.1A	8.65	9.55	1.0	7.78	50	44.8	13.4
P6KE10	9.00	11.0	1.0	8.10	10	40	15.0
P6KE10A	9.50	10.5	1.0	8.55	10	41.4	14.5
P6KE11	9.90	12.1	1.0	8.92	5.0	37	16.2
P6KE11A	10.5	11.6	1.0	9.40	5.0	38.5	15.6
P6KE12	10.8	13.2	1.0	9.72	5.0	34.7	17.3
P6KE12A	11.4	12.6	1.0	10.2	5.0	35.9	16.7
P6KE13	11.7	14.3	1.0	10.5	5.0	31.6	19.0
P6KE13A	12.4	13.7	1.0	11.1	5.0	33	18.2
P6KE15	13.5	16.5	1.0	12.1	5.0	27.3	22.0
P6KE15A	14.3	15.8	1.0	12.8	5.0	28.3	21.2
P6KE16	14.4	17.6	1.0	12.9	5.0	25.5	23.5
P6KE16A	15.2	16.8	1.0	13.6	5.0	26.7	22.5
P6KE18	16.2	19.8	1.0	14.5	5.0	22.6	26.5
P6KE18A	17.1	18.9	1.0	15.3	5.0	23.8	25.2
P6KE20	18.0	22.0	1.0	16.2	5.0	20.6	29.1
P6KE20A	19.0	21.0	1.0	17.1	5.0	21.7	27.7
P6KE22	19.8	24.2	1.0	17.8	5.0	18.8	31.9
P6KE22A	20.9	23.1	1.0	18.8	5.0	19.6	30.6
P6KE24	21.6	26.4	1.0	19.4	5.0	17.3	34.7
P6KE24A	22.8	25.2	1.0	20.5	5.0	18.1	33.2
P6KE27	24.3	29.7	1.0	21.8	5.0	15.3	39.1
P6KE27A	25.7	28.4	1.0	23.1	5.0	16	37.5
P6KE30	27.0	33.0	1.0	24.3	5.0	13.8	43.5
P6KE30A	28.5	31.5	1.0	25.6	5.0	14.5	41.4
P6KE33	29.7	36.3	1.0	26.8	5.0	12.6	47.7
P6KE33A	31.4	34.7	1.0	28.2	5.0	13.1	45.7
P6KE36	32.4	39.6	1.0	29.1	5.0	11.5	52.0
P6KE36A	34.2	37.8	1.0	30.8	5.0	12	49.9
P6KE39	35.1	42.9	1.0	31.6	5.0	10.6	56.4
P6KE39A	37.1	41.0	1.0	33.3	5.0	11.1	53.9
P6KE43	38.7	47.3	1.0	34.8	5.0	9.7	61.9
P6KE43A	40.9	45.2	1.0	36.8	5.0	10.1	59.3
P6KE47	42.3	51.7	1.0	38.1	5.0	8.8	67.8
P6KE47A	44.7	49.4	1.0	40.2	5.0	9.3	64.8
P6KE51	45.9	56.1	1.0	41.3	5.0	8.2	73.5
P6KE51A	48.5	53.6	1.0	43.6	5.0	8.6	70.1
P6KE56	50.4	61.6	1.0	45.4	5.0	7.5	80.5
P6KE56A	53.2	58.8	1.0	47.8	5.0	7.8	77.0

TRANSIENT VOLTAGE SUPPRESSORS

600W SERIES TVS DIODES / DO-15 (CASE 8) 600W

TYPE	Breakdown Voltage		@I _T (mA)	Reverse Stand off Voltage V _{WM} (Volts)	Maximum Reverse Leakage at V _{WM} I _D (uA)	Maximum Peak Pulse Current I _{PPM} (Amps)	Maximum Clamping Voltage at I _{PPM} V _C (Volts)
	V _{BR} (Volts)						
	MIN.	MAX.					
P6KE62	55.8	68.2	1.0	50.2	5.0	6.7	89.0
P6KE62A	58.9	65.1	1.0	53.0	5.0	7.1	85.0
P6KE68	61.2	74.8	1.0	55.1	5.0	6.1	98.0
P6KE68A	64.6	71.4	1.0	58.1	5.0	6.5	92.0
P6KE75	67.5	82.5	1.0	60.7	5.0	5.6	108
P6KE75A	71.3	78.8	1.0	64.1	5.0	5.8	103
P6KE82	73.8	90.2	1.0	66.4	5.0	5.1	118
P6KE82A	77.9	86.1	1.0	70.1	5.0	5.3	113
P6KE91	81.9	100	1.0	73.7	5.0	4.6	131
P6KE91A	86.5	95.5	1.0	77.8	5.0	4.8	125
P6KE100	90.0	110	1.0	81.0	5.0	4.2	144
P6KE100A	95.0	105	1.0	85.5	5.0	4.4	137
P6KE110	99.0	121	1.0	89.2	5.0	3.8	158
P6KE110A	105	116	1.0	94.0	5.0	3.9	152
P6KE120	108	132	1.0	97.2	5.0	3.5	173
P6KE120A	114	126	1.0	102	5.0	3.6	165
P6KE130	117	143	1.0	105	5.0	3.2	187
P6KE130A	124	137	1.0	111	5.0	3.4	179
P6KE150	135	165	1.0	121	5.0	2.8	215
P6KE150A	143	158	1.0	128	5.0	2.9	207
P6KE160	144	176	1.0	130	5.0	2.6	230
P6KE160A	152	168	1.0	136	5.0	2.7	219
P6KE170	153	187	1.0	138	5.0	2.5	244
P6KE170A	162	179	1.0	145	5.0	2.6	234
P6KE180	162	198	1.0	146	5.0	2.3	258
P6KE180A	171	189	1.0	154	5.0	2.4	246
P6KE200	180	220	1.0	162	5.0	2.1	287
P6KE200A	190	210	1.0	171	5.0	2.2	274
P6KE220	198	242	1.0	175	5.0	1.7	344
P6KE220A	209	231	1.0	185	5.0	1.8	328
P6KE250	225	275	1.0	202	5.0	1.7	360
P6KE250A	237	263	1.0	214	5.0	1.7	344
P6KE300	270	330	1.0	243	5.0	1.4	430
P6KE300A	285	315	1.0	256	5.0	1.4	414
P6KE325	292	358	1.0	263	5.0	1.3	462
P6KE325A	309	341	1.0	278	5.0	1.3	448
P6KE350	315	385	1.0	284	5.0	1.2	504
P6KE350A	332	368	1.0	300	5.0	1.2	482
P6KE400	360	440	1.0	324	5.0	1.0	574
P6KE400A	380	420	1.0	342	5.0	1.1	548
P6KE440	396	484	1.0	356	5.0	0.95	631
P6KE440A	418	462	1.0	376	5.0	1.0	602

- Notes :
1. V_{BR} measured after I_T applied for 300ms. I_T = square pulse or equivalent.
 2. For bidirectional use C or CA suffixs for all types (ex. P6KE6.8C,P6KE440CA) electrical characteristics apply in both directions.
 3. For bidirectional types having V_{WM} of 10 volts and less, the I_D limit is doubled.
 4. All devices UL listed file# E211196.



Attachment information about P6KE Series

1. Marking on the body

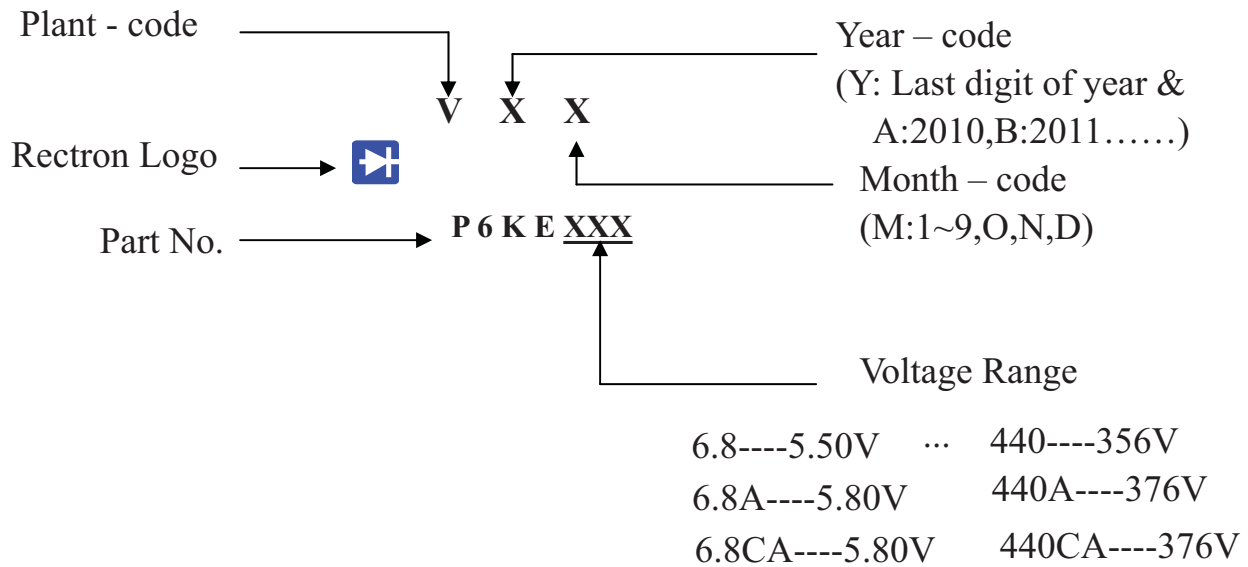

PACKAGING OF DIODE AND BRIDGE RECTIFIERS

BULK PACK

PACKAGE	PACKING CODE	EA PER BOX	INNER BOX SIZE (mm)	CARTON SIZE (mm)	EA PER CARTON	GROSS WEIGHT(Kg)
DO-15	-B	500	194*84*21	415*220*255	25,000	12.74

REEL PACK

PACKAGE	PACKING CODE	EA PER REEL	EA PER INNER BOX	COMPONENT SPACE (mm)	TAPE SPACE (mm)	REEL DIA (mm)	CARTON SIZE (mm)	EA PER CARTON	GROSS WEIGHT(Kg)
DO-15	-T	4,000	4,000	5.0	52	330	355*350*335	16,000	10.05

AMMO PACK

PACKAGE	PACKING CODE	REEL (EA)	COMPONENT SPACE(mm)	TAPE SPACE (mm)	BOX SIZE (mm)	CARTON SIZE(mm)	CARTON (EA)	GROSS WEIGHT (Kg)
DO-15	-F	1,500	5.0	52	255*73*100	400*268*225	15,000	8.8

DISCLAIMER NOTICE

Rectron Inc reserves the right to make changes without notice to any product specification herein, to make corrections, modifications, enhancements or other changes. Rectron Inc or anyone on its behalf assumes no responsibility or liability for any errors or inaccuracies. Data sheet specifications and its information contained are intended to provide a product description only. "Typical" parameters which may be included on RECTRON data sheets and/ or specifications can and do vary in different applications and actual performance may vary over time. Rectron Inc does not assume any liability arising out of the application or use of any product or circuit.

Rectron products are not designed, intended or authorized for use in medical, life-saving implant or other applications intended for life-sustaining or other related applications where a failure or malfunction of component or circuitry may directly or indirectly cause injury or threaten a life without expressed written approval of Rectron Inc. Customers using or selling Rectron components for use in such applications do so at their own risk and shall agree to fully indemnify Rectron Inc and its subsidiaries harmless against all claims, damages and expenditures.

Mouser Electronics

Authorized Distributor

Click to View Pricing, Inventory, Delivery & Lifecycle Information:

Rectron:

[P6KE20C-T](#) [P6KE170CA-T](#) [P6KE15C-B](#) [P6KE15C-T](#) [P6KE62-T](#) [P6KE75CA-T](#) [P6KE180C-T](#) [P6KE16A-T](#)
[P6KE82CA-T](#) [P6KE6.8A-T](#) [P6KE6.8A-B](#) [P6KE43C-T](#) [P6KE150-T](#) [P6KE33A-T](#) [P6KE200-T](#) [P6KE82C-T](#) [P6KE100-T](#)
[P6KE200C-T](#) [P6KE75A-T](#) [P6KE36CA-T](#) [P6KE24A-B](#) [P6KE24A-T](#) [P6KE10CA-B](#) [P6KE91C-T](#) [P6KE9.1A-T](#)
[P6KE9.1A-B](#) [P6KE51A-T](#) [P6KE51A-B](#) [P6KE27C-T](#) [P6KE6.8C-T](#) [P6KE7.5A-T](#) [P6KE16C-T](#) [P6KE68-T](#) [P6KE180A-T](#)
[P6KE20CA-T](#) [P6KE15A-T](#) [P6KE20A-T](#) [P6KE8.2CA-T](#) [P6KE8.2CA-B](#) [P6KE27A-T](#) [P6KE6.8-B](#) [P6KE6.8-T](#)
[P6KE100CA-T](#) [P6KE200CA-T](#) [P6KE100CA-B](#) [P6KE33-T](#) [P6KE250CA-B](#) [P6KE150CA-B](#) [P6KE150CA-T](#)
[P6KE250CA-T](#) [P6KE33CA-T](#) [P6KE220CA-T](#) [P6KE27CA-T](#) [P6KE22CA-T](#) [P6KE120-T](#) [P6KE56CA-T](#) [P6KE39-T](#)
[P6KE30CA-T](#) [P6KE51-T](#) [P6KE56C-T](#) [P6KE24CA-B](#) [P6KE24CA-T](#) [P6KE27-T](#) [P6KE68CA-T](#) [P6KE68A-T](#) [P6KE13A-](#)
[T](#) [P6KE36A-T](#) [P6KE180-T](#) [P6KE110CA-T](#) [P6KE16-T](#) [P6KE6.8CA-B](#) [P6KE6.8CA-T](#) [P6KE11CA-T](#) [P6KE10A-T](#)
[P6KE12-T](#) [P6KE12CA-T](#) [P6KE43A-T](#) [P6KE33C-T](#) [P6KE43-T](#) [P6KE47CA-T](#) [P6KE170A-T](#) [P6KE120C-T](#)
[P6KE180CA-T](#) [P6KE75-T](#) [P6KE160CA-T](#) [P6KE24-T](#) [P6KE22A-T](#) [P6KE8.2A-B](#) [P6KE160A-T](#) [P6KE110C-T](#)
[P6KE47C-T](#) [P6KE18-T](#) [P6KE91CA-B](#) [P6KE91CA-T](#) [P6KE68C-T](#) [P6KE13C-T](#) [P6KE36C-T](#) [P6KE100C-T](#)
[P6KE150A-T](#) [P6KE18C-T](#)