

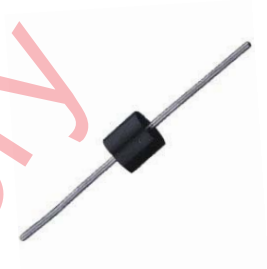

FEATURES

- ✧ Plastic package.
- ✧ Glass passivated junction.
- ✧ 15,000W Peak Pulse Power capability on 10/1000µs waveform.
- ✧ Excellent clamping capability.
- ✧ Repetition rate (duty cycle): 0.05%.
- ✧ Low incremental surge resistance.
- ✧ Fast response time: typically less than 1.0ps from 0 volt to BV, Bidirectional less than 10ns.
- ✧ High temperature soldering guaranteed: 265°C/10 seconds/.375", (9.5mm) lead length, 5lbs, (2.3kg) tension.



P600

MECHANICAL DATA

- ✧ Case: Molded plastic over glass passivated junction.
- ✧ Terminals: Plated Axial leads, solderable per MIL-STD-750, Method 2026.
- ✧ Polarity: Color band denotes cathode except Bipolar.
- ✧ Mounting Position: Any.
- ✧ Weight: 0.07 ounce, 2.5 grams.

DEVICES FOR BIPOLAR APPLICATION

For Bidirectional use C or CA suffix for type 15KPA17 through type 15KPA280 (e.g. 15KPA17C, 15KPA280CA); Electrical characteristics apply in both directions.

MAXIMUM RATINGS AND CHARACTERISTICS

Ratings at 25°C ambient temperature unless otherwise specified.

RATING	SYMBOL	VALUE	UNIT
Peak Pulse Power Dissipation on 10/1000µs waveform. (Note 1, Fig. 1)	P _{PPM}	Minimum 15,000	Watts
Peak Pulse Current on 10/1000µs waveform. (Note 1, Fig. 3)	I _{PPM}	See Table	Amps
Steady State Power Dissipation at T _L = 75°C, Lead length .375" (9.5mm). (Fig. 5)	P _{M(AV)}	8.0	Watts
Peak Forward Surge Current, 8.3ms Single Half Sine-Wave Superimposed on Rated Load. (JEDEC Method) (Note 2, Fig. 6)	I _{FSM}	400	Amps
Operating Junction and Storage Temperature Range.	T _J , T _{STG}	-55 to +175	°C

- Notes:
1. Non-repetitive current pulse, per Fig. 3 and derated above T_A = 25°C per Fig. 2.
 2. 8.3ms single half sine-wave, or equivalent square wave, Duty cycle = 4 pulses per minute maximum.



PACKAGE DIMENSIONS

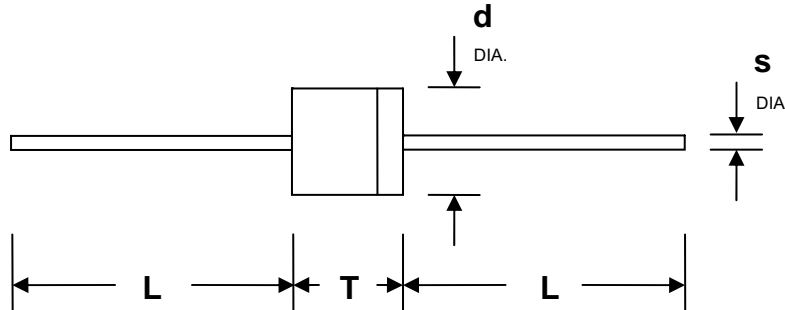

P600

Item	Millimeters		Inches	
	Min.	Max.	Min.	Max.
L	25.40	-	1.000	-
T	8.60	9.10	0.340	0.360
d	8.60	9.10	0.340	0.360
s	1.22	1.32	0.048	0.052

SPECIFICATIONS

Part Number		Reverse Stand-Off Voltage	Breakdown Voltage MIN. @ I _T	Test Current	Maximum Clamping Voltage @ I _{PP}	Peak Pulse Current	Reverse Leakage @ V _{RWM}
UNI-POLAR	BI-POLAR	V _{RWM} (V)	V _{BR MIN.} (V)	I _T (mA)	V _C (V)	I _{PP} (A)	I _R (μA)
15KPA17A	15KPA17CA	17.0	18.99	50	29.3	515.4	5000
15KPA18A	15KPA18CA	18.0	20.11	50	30.9	488.7	5000
15KPA20A	15KPA20CA	20.0	22.34	20	34.3	440.2	1500
15KPA22A	15KPA22CA	22.0	24.57	10	37.1	407.0	500
15KPA24A	15KPA24CA	24.0	26.81	5	40.7	371.0	150
15KPA26A	15KPA26CA	26.0	29.04	5	44.0	343.2	50
15KPA28A	15KPA28CA	28.0	31.28	5	47.5	317.9	25
15KPA30A	15KPA30CA	30.0	33.51	5	50.7	297.8	15
15KPA33A	15KPA33CA	33.0	36.90	5	54.7	276.1	2
15KPA36A	15KPA36CA	36.0	40.20	5	59.8	252.5	2
15KPA40CA	15KPA40CA	40.0	44.70	5	65.8	229.5	2



SPECIFICATIONS

Part Number		Reverse Stand-Off Voltage	Breakdown Voltage MIN.@I _T	Test Current	Maximum Clamping Voltage @I _{PP}	Peak Pulse Current	Reverse Leakage @ V _{RWM}
UNI-POLAR	BI-POLAR	V _{RWM} (V)	V _{BR MIN.} (V)	I _T (mA)	V _C (V)	I _{PP} (A)	I _R (μA)
15KPA43A	15KPA43CA	43.0	48.00	5	69.8	216.3	2
15KPA45A	15KPA45CA	45.0	50.30	5	72.8	207.4	2
15KPA48A	15KPA48CA	48.0	53.60	5	77.7	194.3	2
15KPA51A	15KPA51CA	51.0	57.00	5	82.9	182.1	2
15KPA54A	15KPA54CA	54.0	60.30	5	87.7	172.2	2
15KPA58A	15KPA58CA	58.0	64.80	5	93.8	161.0	2
15KPA60A	15KPA60CA	60.0	67.00	5	97.4	155.0	2
15KPA64A	15KPA64CA	64.0	71.50	5	104.2	144.9	2
15KPA70A	15KPA70CA	70.0	78.2	5	113.6	132.9	2
15KPA75A	15KPA75CA	75.0	83.8	5	122.0	123.8	2
15KPA78A	15KPA78CA	78.0	87.10	5	126.1	119.7	2
15KPA85A	15KPA85CA	85.0	94.90	5	137.6	109.7	2
15KPA90A	15KPA90CA	90.0	100.50	5	145.6	103.7	2
15KPA100A	15KPA100CA	100.0	111.70	5	161.3	93.6	2
15KPA110A	15KPA110CA	110.0	122.90	5	178.6	84.5	2
15KPA120A	15KPA120CA	120.0	134.00	5	192.3	78.5	2
15KPA130A	15KPA130CA	130.0	145.20	5	208.3	72.5	2
15KPA150A	15KPA150CA	150.0	167.60	5	241.9	62.4	2
15KPA160A	15KPA160CA	160.0	178.70	5	258.6	58.4	2
15KPA170A	15KPA170CA	170.0	189.90	5	272.7	55.4	2
15KPA180A	15KPA180CA	180.0	201.10	5	288.5	52.3	2
15KPA200A	15KPA200CA	200.0	223.40	5	319.1	47.3	2
15KPA220A	15KPA220CA	220.0	245.70	5	352.5	42.8	2
15KPA240A	15KPA240CA	240.0	268.10	5	384.6	39.3	2
15KPA260A	15KPA260CA	260.0	290.40	5	416.7	36.2	2
15KPA280A	15KPA280CA	280.0	312.80	5	454.5	33.2	2

Note: For Bidirectional type having V_{RWM} of 10 volts and less, the I_R limit doubles.



RATING AND CHARACTERISTIC CURVES (TA: 25°C UNLESS OTHERWISE SPECIFIED)

Figure 1 - Peak Pulse Power Rating Curve

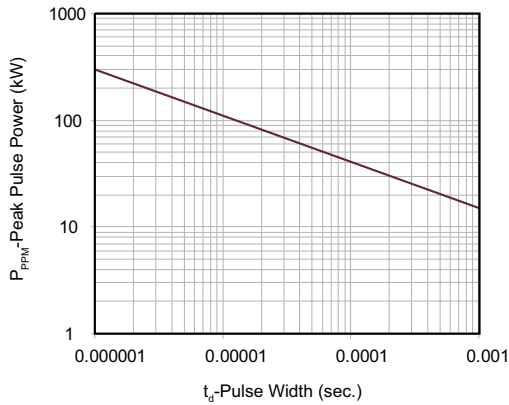

Figure 2 - Pulse Derating Curve

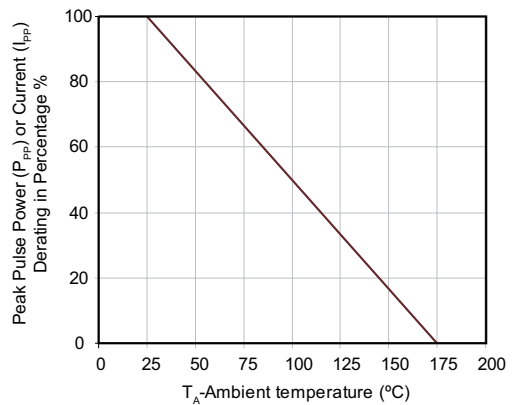

Figure 3 - Pulse Waveform

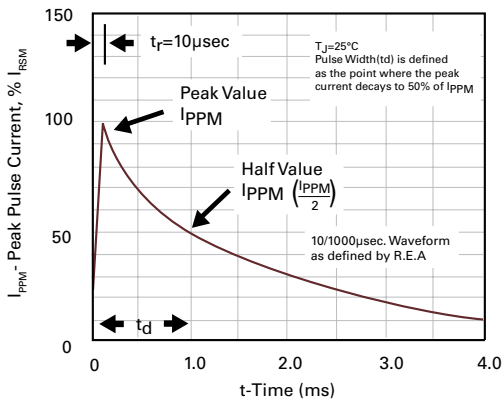

Figure 4 - Typical Junction Capacitance

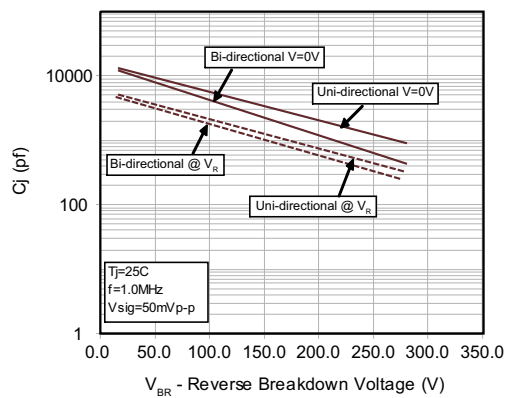

Figure 5 - Steady State Power Dissipation Derating Curve

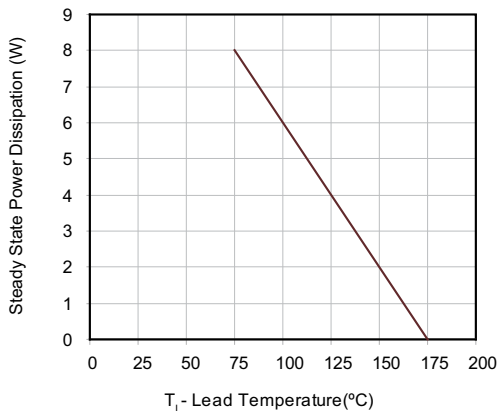

Figure 6 - Maximum Non-Repetitive Forward Surge Current Uni-Directional Only

