

Introduction

Linear Technology Corporation (LTC) was founded in 1981 to address the growing demand for high performance and superior quality linear integrated circuits.

Today, LTC has successfully established a leadership position by introducing and supplying leading edge products in each of the industry's basic functional groups— op amps, comparators, voltage regulators, references, switched-capacitor filters, interface, data conversion, and a variety of special function CMOS devices, in all major package styles.

Early on, LTC made the commitment to provide advanced technology, *surface mount packaging*. This made Linear Technology the first company to offer true precision and high performance linear devices across the full range of functional categories, plus many of the popular second-source devices in JEDEC/EIAJ Standard packages:

SO (0.150) 8, 14, 16

SO (0.300) 16, 18, 20, 24, 28

SSOP (0.150) 16, 20, 24, 28

SSOP (5.3mm) 16, 20, 24, 28, 36

SSOP (7.62mm) 36, 44

TSSOP (4.4mm) 20

TSSOP (6.1mm) 48, 56

The continuing demand for more complete surface mount designs has spurred the introduction of four power surface mount packages by LTC: the 3-lead SOT-223, the DD package available in 3-, 5- and 7-lead versions, the SOT-23 package available in 3-, 5- and 6-lead versions and the 4-lead SOT-143. Many LTC power products are now being introduced in these packages which, for the first time, enable high power designs to be realized using 100% surface mount devices. Support for LTC's surface mount devices includes service for tape and reel, antistatic rails, quality and reliability data, and data sheets on each product.

LTC intends to address customer demand for surface mount devices where technology and die sizes permit, making the combination of small package size and high performance linear devices readily available to our users.

This section contains information summarizing LTC's capabilities and services for surface mount packaged products, as well as specific device data sheets.

Package Descriptions

LTC's SO packages conform to Standard JEDEC Small Outline drawings.

In some instances, an LTC product available in an 8-pin standard DIP package is offered in a 16-pin SO package. This covers the situation where the die is too large to be accommodated by the smaller SO-8 package. Although it is preferable for an SO-8 device to have the same pinout as the standard 8-pin dual-in-line version, some devices necessitate a rotation of the die to fit in the SO-8 package. Please refer to the applicable SO device data sheet, or consult with the factory to verify exact pinouts for each device.

Electrical Specifications

Wherever possible, electrical specifications for a surface mount technology (SMT)* device are the same as the plastic molded equivalent. Exceptions to this are identified by the omission of the standard product electrical grade designator from the part number.

For example:

- LT1013DS8 has the same electrical specifications as LT1013DN8, since the "D" is common to both product numbers.
- LT1012S8 has one or more different electrical specifications than LT1012CN8, as the "C" is missing from this product designator suffix.

Please consult the appropriate SMT package data sheet for complete electrical specifications.

* Terminology: SO = Small Outline, SOT = Small Outline Transistor, SSOP = Shrink Small Outline Package, TSSOP = Thin Shrink Small Outline Package.

LTC package code designators for SMT products are:
F = 4.4mm Body TSSOP, FW = 6.1mm Body TSSOP, G = 5.3mm Body SSOP, GN = 0.150 Body SSOP, GW = 0.300 Body SSOP, M, Q and R = DD Pak, S = 0.150 Body SO, SW = 0.300 Body SO, ST = SOT-223.

SURFACE MOUNT PRODUCTS

Marking

Because of the limited space available for part marking on some SMT packages, abbreviated marking codes are used to identify the device. These codes, if used, are identified in the individual SMT package data sheets.

Lead Finish and Solderability

Lead finish is electroplated, lead-tin, with a low carbon content. Solderability meets the requirements of MIL-STD-883C, Method 2003. Recommended minimum solder pad dimensions are given in Figure 1. (Note: Consideration should be given to your process and power requirements.)

Recommended Solder Pad Pitch and Dimensions

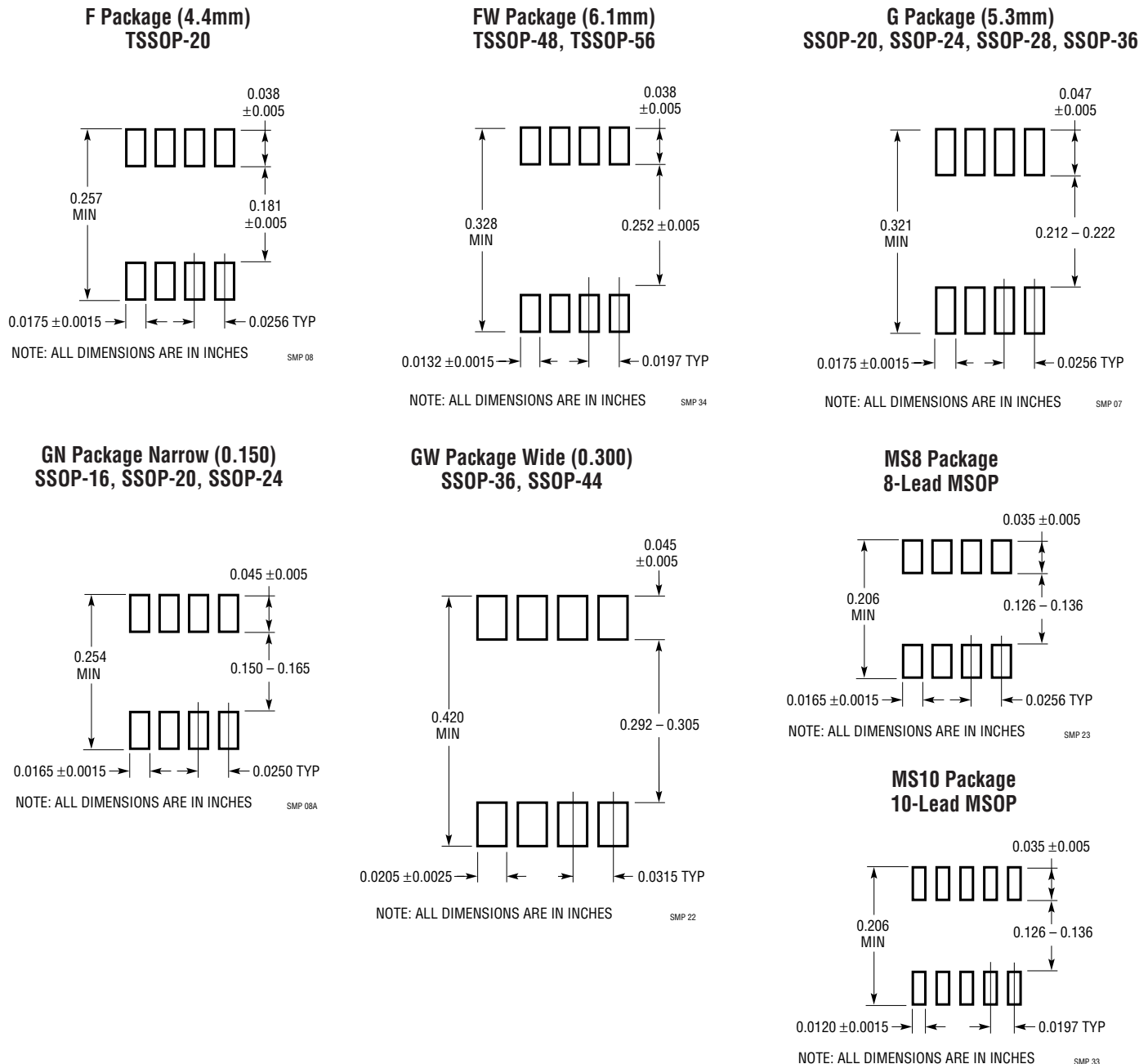
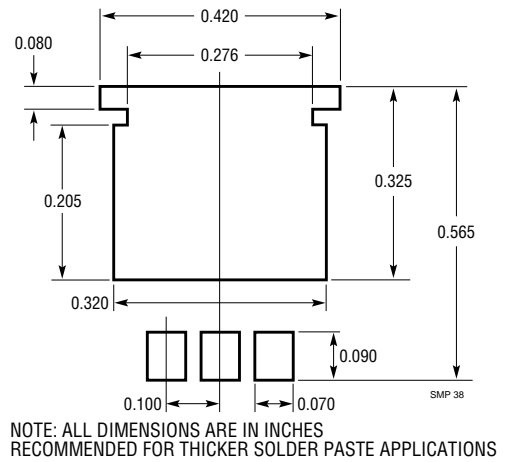
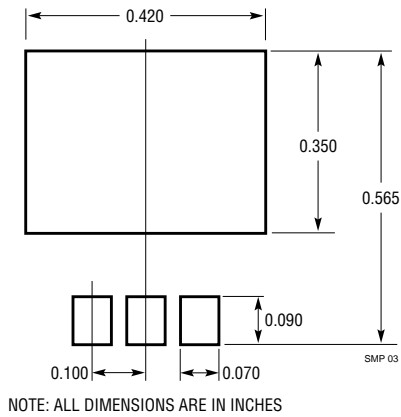

Figure 1. Recommended Solder Pads

SURFACE MOUNT PRODUCTS

M Package 3-Lead DD



Q Package 5-Lead DD

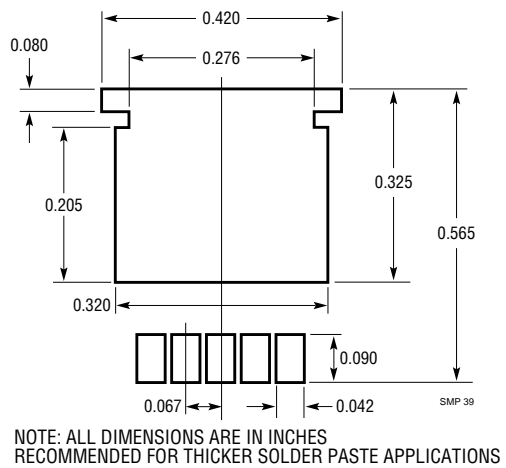
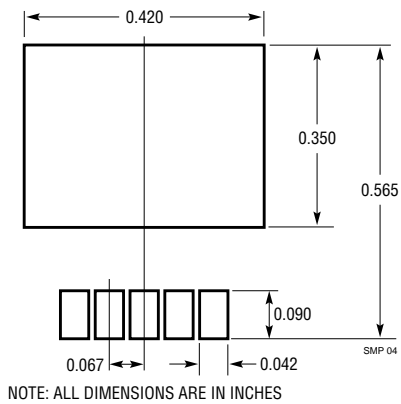

R Package 7-Lead DD

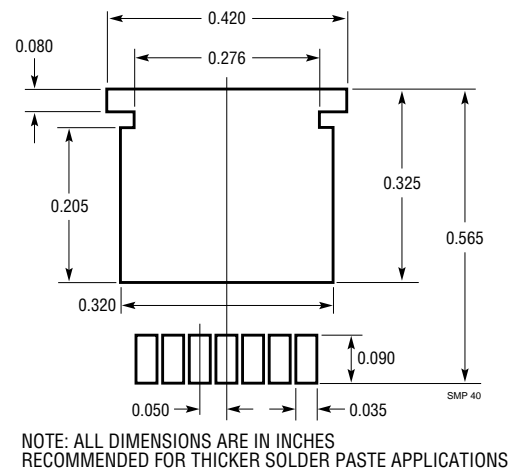
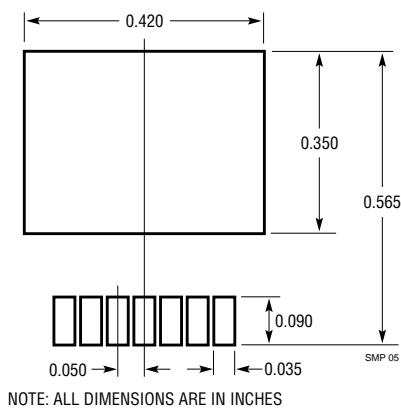
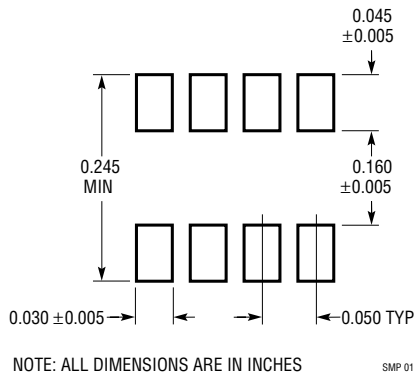

Figure 1. Recommended Solder Pads (Continued)

SURFACE MOUNT PRODUCTS

S Package (0.150)
SO-8, SO-14, SO-16



NOTE: ALL DIMENSIONS ARE IN INCHES

ST Package
3-Lead SOT-223

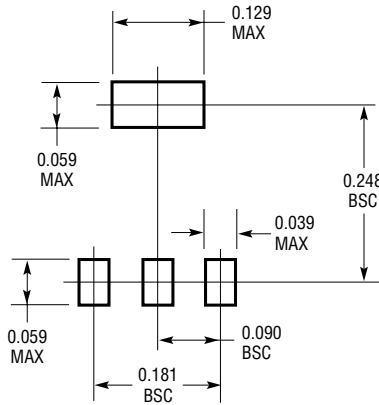

NOTE: ALL DIMENSIONS ARE IN INCHES

SW Package Wide (0.300)
SO-16, SO-18, SO-20, SO-24, SO-28

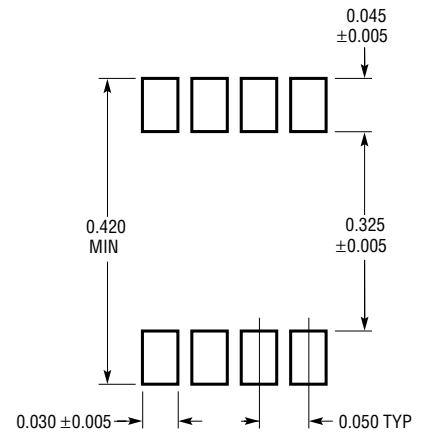

NOTE: ALL DIMENSIONS ARE IN INCHES

S3 Package
3-Lead SOT-23

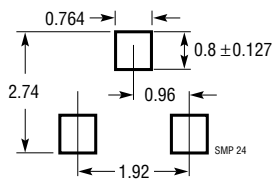

NOTE: ALL DIMENSIONS ARE IN MILLIMETERS

S5 Package
5-Lead SOT-23

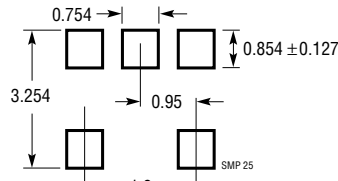

NOTE: ALL DIMENSIONS ARE IN MILLIMETERS

S6 Package
6-Lead SOT-23

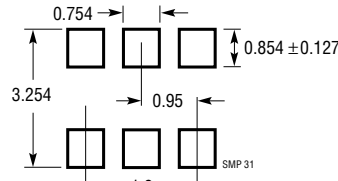

NOTE: ALL DIMENSIONS ARE IN MILLIMETERS

S4 Package
4-Lead SOT-143

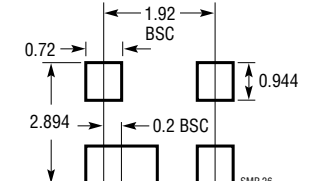

NOTE: ALL DIMENSIONS ARE IN MILLIMETERS

T3 Package
3-Lead TO-220
(Flow 32)

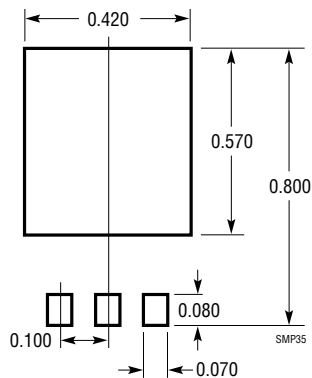

NOTE: ALL DIMENSIONS ARE IN INCHES

T5 Package
5-Lead TO-220
(Flow 33)

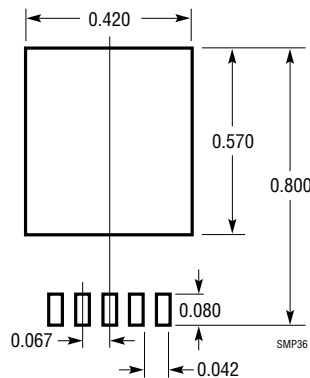

NOTE: ALL DIMENSIONS ARE IN INCHES

T7 Package
7-Lead TO-220
(Flow 35)

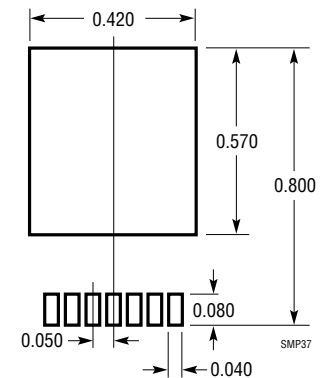

NOTE: ALL DIMENSIONS ARE IN INCHES

Figure 1. Recommended Solder Pads (Continued)

Wave and Reflow Soldering

Following are the recommended procedures for soldering surface mount packages to PC boards.

1. Reflow Soldering

- Use of solder plating boards is recommended.
- Screen solder paste on board.
- Mount components on board.
- Infrared or forced hot air convection reflow is recommended for best performance. Parameters:
 - Preheat peak temperature $125^{\circ}\text{C} \pm 15^{\circ}\text{C}$ and 2°C to 4°C per second rise
 - Activation temperature 130°C to 150°C
 - Reflow begins at 183°C (63Sn/37Pb)
 - Time above 183°C for 30 seconds
 - Peak package body temperature 220°C to 240°C
 - Dwell time at peak temperature 10 seconds max
 - Cooling rate 2°C to 4°C per second
- Clean boards.
- For Vapor Phase Reflow, recommended parameter ranges for:
 - Heating rate: 4°C per second max
 - Preheat temperature: 45°C to 80°C
 - Time above 200°C : 50 seconds to 90 seconds
 - Peak package temperature: 212°C to 219°C

2. Wave Soldering

- Use solder plating boards.
- Dispense adhesive to hold components on board.
- Place components on board.
- Cure adhesive per adhesive manufacturer's specification.
- Preheat package temperature shall be between 100°C and 130°C .
- Foam flux using RMA (Rosin Mildly Activating) flux.
- Wave solder using a dual wave soldering system at 230°C to 250°C for 2 seconds per wave.
- Clean board.
- **Wave soldering is not recommended for SOT-223 package.**

3. Hand Soldering

- **Hand soldering of packages is not recommended.**

Dry Pack in Moisture Barrier Bags

In the event of a requirement for Dry Pack, LTC employs as a guideline the methods of IPC-SM-786A, Procedures for Characterization of Moisture/Reflow Sensitive ICs.

Thermal Information

Table 1 shows the range of junction-to-ambient thermal resistance of SO devices mounted on a PCB of FR4 material with copper traces, in still air at 25°C . θ_{JA} with a ceramic substrate is about 70% of the FR4 value. Maximum power dissipation may be calculated by the following formula:

$$P_{\text{DMAX}}(T_A) = \frac{T_{\text{JMAX}} - T_A}{\theta_{JA}}$$

where,

T_{JMAX} = Maximum operating junction temperature.

T_A = Desired ambient operating temperature.

θ_{JA} = Junction-to-ambient thermal resistance.

Table 1. Typical Thermal Resistance Values

SO-8	150°C/W to 200°C/W	SO-18	70°C/W to 100°C/W
SO-14	100°C/W to 140°C/W	SO-20	70°C/W to 90°C/W
SO-16 (0.150)	90°C/W to 130°C/W	SO-24	60°C/W to 80°C/W
SO-16 (0.300)	85°C/W to 100°C/W	SO-28	55°C/W to 75°C/W

Conditions: PCB mount on FR4 material, still air at 25°C , copper trace.

Thermal resistance for power packages (DD and SOT-223) depends greatly on the individual device type. Please consult the device data sheets for thermal information.

More current data, by device type, may be obtained by contacting LTC, Marketing Department.

Tape and Reel Packing (See Tape and Reel Section)

Plastic Tube Packing

LTC's Surface Mount products are packed in "antistatic" plastic tubes with the tube dimensions indicated in Figure 2. Unit quantities packaged per tube are listed below in Table 2.

Table 2. Devices Per Tube

LTC Package Code Designator	LTC Package Style	Actual Lead Count	Number of Units
F	TSSOP (4.4mm)	20	74
FW	TSSOP (6.1mm)	48	39
FW	TSSOP (6.1mm)	56	35
G	SSOP (5.3mm)	16	77
G	SSOP (5.3mm)	20	66

SURFACE MOUNT PRODUCTS

Table 2. Devices Per Tube (continued)

LTC Package Code Designator	LTC Package Style	Actual Lead Count	Number of Units
G	SSOP (5.3mm)	24	59
G	SSOP (5.3mm)	28	47
G	SSOP (5.3mm)	36	37
GN	SSOP (0.150)	16	100
GN	SSOP (0.150)	20, 24	55
GW	SSOP (7.62mm)	36	32
GW	SSOP (7.62mm)	44	27
MS8	MSOP (0.118)	8	50
MS10	MSOP (0.118)	10	50

M, Q, R	DD	3, 5, 7	50
S8	S8 (0.150)	8	100
S	S (0.150)	14	55
S	S (0.150)	16	50
ST	SOT-223	3	78
SW	SW (0.300)	16	47
SW	SW (0.300)	18	40
SW	SW (0.300)	20	38
SW	SW (0.300)	24	32
SW	SW (0.300)	28	27

PLASTIC TUBE SPECIFICATIONS

**MSOP
MS8 Package Shipping Tube**

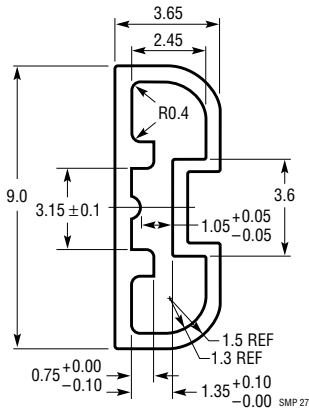

NOTE: ALL DIMENSIONS ARE IN MILLIMETERS
 TYP RADIUS: 0.2
 MATERIAL THICKNESS: 0.6
 MSOP 8LD POLYCARBONATE TUBE TO BE ANTISTATIC
 COMPLIANT PER LTC SPEC 01-99-0001

**ST
SOT-223 Package Shipping Tube**

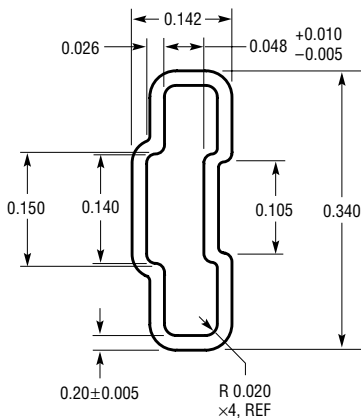

NOTE: ALL DIMENSIONS ARE IN INCHES

**S (0.150)
SO Package Shipping Tube**

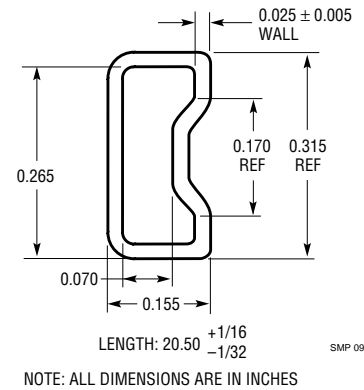

NOTE: ALL DIMENSIONS ARE IN INCHES

**SW (0.300)
SO Package Shipping Tube**

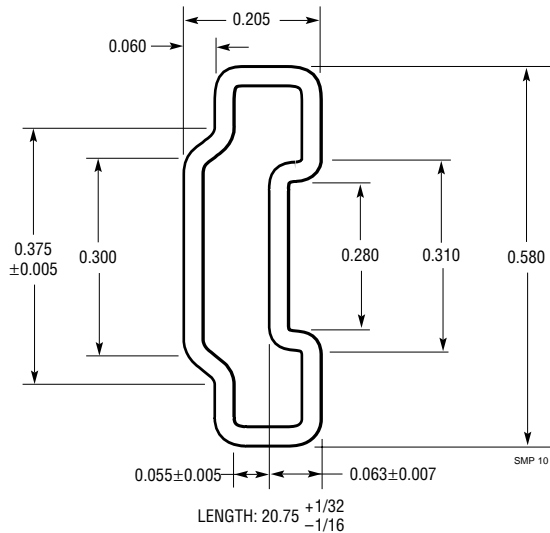

NOTE: ALL DIMENSIONS ARE IN INCHES, ±0.010 UNLESS OTHERWISE SPECIFIED
 MATERIAL: ANITSTATIC TREATED RIGID TRANSPARENT PVC OR RIGID BLACK CONDUCTIVE
 PRINTING: "LTC LOGO, LINEAR TECHNOLOGY CORP., ANTISTATIC" ON TOPSIDE OF TUBE

Figure 2

SURFACE MOUNT PRODUCTS

Micropackage Products, SOT-23, SOT-223, MSOP, SSOP-16

SOT-23 (Codes: S3, S5 or S6)	
FUNCTION	CIRCUITS AVAILABLE
References	LT1460HCS3-x.x LT1460JCS3-x.x LT1460KCS3-x.x
Regulators	LTC1517CS5-3.3 LTC1517CS5-5 LT1611CS5 LT1613CS5
SMBus Accelerator	LTC1694CS5

SOT-223 (Code: ST)	
FUNCTION	CIRCUITS AVAILABLE
Linear Regulators	LT1117CST LT1117CST-x.xx LT1118CST-x.xx LT1121CST-x.x* LT1123CST LT1129CST-x.x* LT1175CST-5* LT1521CST-x.x*

MSOP-8 (Code: MS8)	
FUNCTION	CIRCUITS AVAILABLE
Operational Amplifiers	LT1351CMS8 LT1490CMS8 LTC1541CMS8 LTC1542CMS8 LT1636CMS8 LT1638CMS8
Current Sense Amp	LT1620CMS8
Comparators	LT1394CMS8 LTC1440CMS8 LTC1540CMS8 LTC1541CMS8 LTC1542CMS8 LT1671CMS8 LT1720CMS8
References	LTC1258CMS8-2.5 LT1460CCMS8-xx.x LT1460FCMS8-xx.x LT1634BCMS8-x.xx
D/A Converters	LTC1426CMS8 LTC1658CMS8* LTC1659CMS8 LTC1661CMS8*

A/D Converters	LTC1197LCMS8 LTC1199LCMS8
IrDA Receiver	LT1328CMS8
EIA485 Transceivers	LTC1482CMS8 LTC1484CMS8 LTC1690CMS8
Dual MOSFET Drivers	LTC1693-3CMS8
Linear Regulators	LT1521CMS8 LT1521CMS8-x.x
Charge Pump DC/DC	LTC1522CMS8 LTC1682CMS8 LTC1682CMS8-x.x
Sw. Cap. Inverters	LTC1261LCMS8 LTC1261LCMS8-x.x LTC1550LCMS8 LTC1550LCMS8-x.x LTC1551LCMS8 LTC1551LCMS8-4.1
Switching Regulators	LT1307BMS8 LT1307CMS8 LT1316CMS8 LT1317BCMS8 LT1317CMS8 LTC1474CMS8 LTC1474CMS8-x.x LTC1475CMS8 LTC1475CMS8-x.x LT1610CMS8 LT1614CMS8 LTC1622CMS8
Triple Supply Monitors	LTC1326CMS8 LTC1326CMS8-2.5 LTC1536CMS8
Varactor Driver	LTC1340CMS8
SMBus Switch Drivers	LTC1623CMS8 LTC1710CMS8

SSOP-16 (Code: G OR GN)	
FUNCTION	CIRCUITS AVAILABLE
Current Feedback Amp	LT1395CGN
Current Sense Amps	LT1620IGN LT1620CGN LT1621CGN*
D/A Converters	LTC1660CGN* LTC1665CGN
A/D Converters	LTC1417ACGN LTC1417CGN
Filters	LTC1067-50CGN* LTC1067CGN*
RGB MUX with CFAs	LT1675CGN
Multiplexers	LTC1380CGN* LTC1393CGN*
Dual Switch Drivers	LTC1473CGN*
Hot Swap Controllers	LTC1643HCGN* LTC1643LCGN*
Linear Regulators	LT1579CGN LT1579CGN-x.x
SIM Power Supply	LTC1555CGN*
Backup Battery Ctrls	LTC1558CGN-3.3 LTC1558CGN-5 LTC1559CGN-3.3 LTC1559CGN-5
Battery Chargers	LT1510-5CGN* LT1510CGN* LT1512CGN*
SIM Power Supply	LTC1556CGN
Switch Cap. Inverter	LTC1550CGN* LTC1550LCGN*
Switching Regulators	LTC1430ACGN* LTC1433CGN* LTC1434CGN* LTC1435ACG* LTC1435CG* LTC1473LCGN LTC1625CGN* LTC1735CGN*

* Industrial temperature tested versions also available

SURFACE MOUNT PRODUCTS

Due to the limited amount of space available for marking, LTC surface mount devices of 8 leads and less are marked with an abbreviated code. This is a listing of these codes

by package type and full part number. The designator "LT" may be either the stylized LT logo or block sans serif type depending on marking method used.

8-Lead MSOP MARK	FULL PART NUMBER
LTAA	LT1460CCMS8-2.5
LTAB	LT1460FCMS8-2.5
LTAJ	LT1460CCMS8-5
LTAG	LT1460FCMS8-5
LTAH	LT1460CCMS8-10
LTAL	LT1460FCMS8-10
LTBA	LTC1326CMS8
LTBB	LT1490CMS8
LTBC	LT1620CMS8
LTBE	LTC1541CMS8
LTBF	LT1307BCMS8
LTBG	LT1328CMS8
LTBH	LT1394CMS8
LTBJ	LT1394IMS8
LTBK	LTC1475CMS8
LTBL	LTC1197LCMS8
LTBM	LTC1340CMS8
LTBN	LT1634ACMS8-1.25
LTBQ	LTC1426CMS8
LTBT	LT1351CMS8
LTBU	LT1307CMS8
LTBV	LTC1536CMS8
LTBW	LTC1474CMS8
LTBX	LTC1440CMS8
LTBY	LTC1440IMS8
LTBZ	LTC1317CMS8
LTCB	LTC1482CMS8
LTCB	LTC1482IMS8
LTCB	LTC1316CMS8
LTCB	LTC1540CMS8
LTCB	LTC1258CMS8-2.5
LTCB	LTC1522CMS8
LTCB	LTC1623CMS8
LTCB	LTC1659CMS8
LTCB	LT1636CMS8
LTCM	LTC1199LCMS8
LTCB	LTC1475CMS8-3.3
LTCQ	LTC1475CMS8-5
LTCR	LTC1474CMS8-3.3
LTCB	LTC1474CMS8-5
LTCB	LT1671CMS8
LTCU	LTC1671MS8
LTCV	LT1634BCMS8-1.25
LTCW	LTC1658CMS8
LTCY	LT1638CMS8
LTCZ	LTC1474IMS8
LTDA	LTC1690CMS8
LTDB	LTC1622CMS8
LTDC	LTC1622IMS8
LTDD	LT1634ACMS8-2.5
LTDE	LTC1542CMS8
LTDF	LT1634BCMS8-2.5
LTDG	LT1634ACMS8-4.096
LTDH	LT1634BCMS8-4.096
LTDJ	LT1634ACMS8-5
LTDK	LT1634BCMS8-5
LTDL	LT1317BCMS8
LTDM	LT1121CMS8-3.3
LTDN	LT1389BCMS8-1.25
LTDN	LT1389BCMS8-2.5
LTDQ	LT1389BCMS8-4.096

LTDR	LT1389BCMS8-5
LTDS	LT1720CMS8
LTDT	LT1610CMS8
LTDU	LT1521CMS8-3.3
LTDV	LTC1661CMS8
LTDW	LTC1661IMS8
LTDX	LTC1484CMS8
LTDY	LT1396CMS8
LTDZ	LTC1710CMS8
LTEA	LT1317BMS8
LTEB	LTC1693-3CMS8
LTEC	LTC1502CMS8-3.3
LTEG	LTC1550LCMS8
LTEH	LTC1550LCMS8-4.1
LTEJ	LT1614CMS8
LTEK	LTC1326CMS8-2.5
LTEL	LTC1258CMS8
LTEM	LTC1258CMS8-5
LTEO	LTC1258CMS8-4.1
LTEQ	LTC1663CMS8
LTER	LT1682CMS8
LTEU	LTC1258CMS8-3.0
LTEZ	LT1521CMS8
LTFA	LT1521CMS8-5
LTFB	LT1521CMS8-3
LTFC	LT1197CMS8
LTFD	LTC1550LIMS8
LTFF	LTC1550LIMS8-4.1
LTFF	LT1494CMS8
LTFG	LT1494IMS8
LTFF	LT1672CMS8
LTFF	LT1672IMS8
LTFL	LTC1199CMS8
LTFF	LTC1261LCMS8
LTFF	LTC1261LCMS8-4
LTFF	LTC1261LCMS8-4.5
LTFF	LTC1551LCMS8
LTFF	LTC1551LCMS8-2
LTFF	LTC1551LCMS8-2.5
LTFF	LTC1551LCMS8-4.1
LTFF	LTC1550LCMS8-2
LTFF	LTC1550LCMS8-2.5
LTFF	LTC1658IMS8
LTFF	LTC1503CMS8-1.8
LTFF	LTC1503IMS8-1.8
LTFF	LTC1503CMS10
LTFF	LTC1503IMS10
LTFF	LTC1550LCMS8-2
LTFF	LT1610IMS8
LTFF	LTC1682CMS8-3.3
LTFF	LTC1682IMS8-3.3
LTFF	LTC1682CMS8-5
LTFF	LTC1682IMS8-5
LTFF	LT1675CMS8-1
LTFF	LT1675IMS8-1
LTFF	LT1317BCMS8
LTFF	LTC1502IMS8-3.3

10-Lead MSOP MARK NUMBER	FULL PART
LTFF	LTC1503CMS10
LTGA	LTC1503IMS10

8-Lead SO MARK	FULL PART NUMBER
0412	LT1004CS8-1.2
0412I	LT1004IS8-1.2
0425	LT1004CS8-2.5
0425I	LT1004IS8-2.5
04AI33	LTC1504AIS8-3.3
1001	LT1001CS8
1006	LT1006S8
1007	LT1007CS8
1007I	LT1007IS8
1008	LT1008S8
1009	LT1009S8
1009I	LT1009IS8
1011	LT1011CS8
1012	LT1012S8
1013	LT1013DS8
1013I	LT1013IS8
1016	LT1016CS8
1016I	LT1016IS8
1017	LT1017CS8
1017I	LT1017IS8
1018	LT1018CS8
1026	LT1026CS8
1026I	LT1026IS8
1027C5	LT1027CCS8-5
1027D5	LT1027DCS8-5
1027E5	LT1027ECS8-5
1028	LT1028CS8
1034I12	LT1034IS8-1.2
1037	LT1037CS8
1041	LTC1041CS8
1044	LTC1044CS8
1044/R	LTC1044CS8/R
1044A	LTC1044ACS8
1044AI	LTC1044AIS8
1046	LTC1046CS8
1046I	LTC1046IS8
1049	LTC1049CS8
1050	LTC1050CS8
1054	LT1054CS8
1054A	LT1054ACS8
1054I	LT1054IS8
1054L	LT1054LCS8
1055	LT1055S8
1056	LT1056S8
1057	LT1057S8
1057I	LT1057IS8
10691	LTC1069-1CS8
10691I	LTC1069-1IS8
10696	LTC1069-6CS8
10696I	LTC1069-6IS8
10697	LTC1069-7CS8
10697I	LTC1069-7IS8
1072	LT1072CS8
1073	LT1073CS8
10731	LT1073CS8-12
10735	LT1073CS8-5
1077	LT1077S8
1077I	LT1077IS8
1078	LT1078S8
1078I	LT1078IS8
10905	LT1109CS8-5

10912	LT1109CS8-12
1096	LTC1096CS8
1096A	LTC1096ACS8
1096AI	LTC1096AIS8
1096I	LTC1096IS8
1096L	LTC1096LCS8
1096LI	LTC1096LIS8
1097	LT1097S8
1098	LTC1098CS8
1098A	LTC1098ACS8
1098AI	LTC1098AIS8
1098I	LTC1098IS8
1098L	LTC1098LCS8
1098LI	LTC1098LIS8
11012	LT1110CS8-12
1107	LT1107CS8
1107I2	LT1107CS8-12
11075	LT1107CS8-5
1107I	LT1107IS8
1108	LT1108CS8
1108I	LT1108CS8-12
11085	LT1108CS8-5
1109	LT1109CS8
1109A	LT1109ACS8
1109A1	LT1109ACS8-12
1109A5	LT1109ACS8-5
1110	LT1110CS8
11105	LT1110CS8-5
1111	LT1111CS8
11111	LT1111CS8-12
11115	LT1111CS8-5
1111I	LT1111IS8
1112	LT1112S8
1113	LT1113CS8
1116	LT1116CS8
1118	LT1118CS8
111825	LT1118CS8-2.5
111828	LT1118CS8-2.85
11185	LT1118CS8-5
1120	LT1120CS8
1120A	LT1120ACS8
1120AI	LT1120AIS8
1121	LT1121CS8
11213	LT1121CS8-3.3
11215	LT1121CS8-5
1121A	LT1121ACS8
1121A3	LT1121ACS8-3.3
1121A5	LT1121ACS8-5
1121I	LT1121IS8
1122C	LT1122CS8
1122D	LT1122DS8
11232	LTC1123CS8-2.85
1124	LT1124CS8
1126	LT1126CS8
1128	LT1128CS8
1129	LT1129CS8
11293	LT1129CS8-3.3
11295	LT1129CS8-5
1129I	LT1129IS8
1129I3	LT1129IS8-3.3
1129I5	LT1129IS8-5
1144	LTC1144CS8
1144I	LTC1144IS8
11473	LTC1147CS8-3.3

SURFACE MOUNT PRODUCTS

11475	LTC1147CS8-5	1208	LT1208CS8	12881	LTC1288IS8	1375HV	LT1375HVCS8
1147I3	LTC1147IS8-3.3	1211	LT1211CS8	1298	LTC1298CS8	1375I	LT1375IS8
1147L	LTC1147LCS8	1211I	LT1211IS8	1298I	LTC1298IS8	1375I5	LT1375IS8-5
1147L3	LTC1147LCS8-3.3	1213	LT1213CS8	1300	LT1300CS8	1376	LT1376CS8
1147LI	LTC1147LIS8	1215	LT1215CS8	1301	LT1301CS8	13765	LT1376CS8-5
1150	LTC1150CS8	1217	LT1217CS8	1301I	LT1301IS8	1376HV	LT1376HVCS8
1152	LTC1152CS8	1218	LT1218CS8	1302	LT1302CS8	1376I	LT1376IS8
1152I	LTC1152IS8	1218L	LT1218LCS8	13025	LT1302CS8-5	1376I5	LT1376IS8-5
1153	LTC1153CS8	1219	LT1219CS8	1303	LT1303CS8	1377	LT1377CS8
1153I	LTC1153IS8	1219L	LT1219LCS8	13035	LT1303CS8-5	1377I	LT1377IS8
1154	LTC1154CS8	121AI	LT1121AIS8	1303I	LT1303IS8	1389B4	LT1389BCS8-4.096
1155	LTC1155CS8	121AI3	LT1121AIS8-3.3	1303I5	LT1303IS8-5	1389B5	LT1389BCS8-5
1155I	LTC1155IS8	121AI5	LT1121AIS8-5	1304	LT1304CS8	1392	LTC1392CS8
1157	LTC1157CS8	121I3	LT1121IS8-3.3	130433	LT1304CS8-3.3	1392I	LTC1392IS8
1163	LTC1163CS8	121I5	LT1121IS8-5	13045	LT1304CS8-5	1394	LT1394CS8
1165	LTC1165CS8	1220	LT1220CS8	1305	LT1305CS8	1394I	LT1394IS8
1166	LT1166CS8	1221	LT1221CS8	1307	LT1307CS8	1400	LTC1400CS8
1167	LT1167CS8	1222	LT1222CS8	1307B	LT1307BCS8	1400I	LTC1400IS8
1167A	LT1167ACS8	1222I	LT1222IS8	1307BI	LT1307BIS8	1401	LTC1401CS8
1167AI	LT1167AIS8	1223	LT1223CS8	1307I	LT1307IS8	1401I	LTC1401IS8
1167I	LT1167IS8	1224	LT1224CS8	1308	LT1308CS8	1404	LTC1404CS8
1169	LT1169CS8	1225	LT1225CS8	1308I	LT1308IS8	1404I	LTC1404IS8
1172	LT1172CS8	1226	LT1226CS8	1309	LT1309CS8	1413	LT1413S8
1172HI	LT1172HVIS8	1227	LT1227CS8	1312	LT1312CS8	1422	LTC1422CS8
1172I	LT1172IS8	1228	LT1228CS8	1316	LT1316CS8	1422I	LTC1422IS8
1173	LT1173CS8	1229	LT1229CS8	1316I	LT1316IS8	14245	LT1424CS8-5
1173I2	LT1173CS8-12	1232	LTC1232CS8	1317	LT1317CS8	14249	LT1424CS8-9
11735	LT1173CS8-5	1232I	LTC1232IS8	1317B	LT1317BCS8	1424I5	LT1424IS8-5
1174	LTC1174CS8	1234	LTC1234CS8	1317BI	LT1317BIS8	1424I9	LT1424IS8-9
117433	LTC1174CS8-3.3	1241	LT1241CS8	1317I	LT1317IS8	1426	LTC1426CS8
117450	LTC1174CS8-5	1241I	LT1241IS8	1326	LTC1326CS8	1426I	LTC1426IS8
1174H	LTC1174HVCS8	1242	LT1242CS8	132625	LTC1326CS8-2.5	142750	LTC1427CS8-50
1174H3	LTC1174HVCS8-3.3	1242I	LT1242IS8	1326I	LTC1326IS8	142850	LTC1428CS8-50
1174H5	LTC1174HVCS8-5	1243	LT1243CS8	1328	LT1328CS8	14294	LTC1429CS8-4
1174HI	LTC1174HVIS8	1243I	LT1243IS8	1328I	LT1328IS8	1430	LTC1430CS8
1174I	LTC1174IS8	1244	LT1244CS8	1329I	LTC1329CS8-10	1430A	LTC1430ACS8
1175	LT1175CS8	1244I	LT1244IS8	13295	LTC1329CS8-50	1430I	LTC1430IS8
11755	LT1175CS8-5	1245	LT1245CS8	1329A5	LTC1329ACS8-50	1431	LT1431CS8
1175I	LT1175IS8	1245I	LT1245IS8	1329I5	LTC1329IS8-50	1431I	LT1431IS8
1175I5	LT1175IS8-5	1246	LT1246CS8	1340	LTC1340CS8	1432	LT1432CS8
1178	LT1178S8	1247	LT1247CS8	1351	LT1351CS8	14323	LT1432CS8-3.3
1187	LT1187CS8	1249	LT1249CS8	1352	LT1352CS8	1440	LTC1440CS8
1189	LT1189CS8	1249I	LT1249IS8	1354	LT1354CS8	1440I	LTC1440IS8
1190	LT1190CS8	1250	LTC1250CS8	1355	LT1355CS8	1441	LTC1441CS8
1191	LT1191CS8	1252	LT1252CS8	1357	LT1357CS8	1441I	LTC1441IS8
1192	LT1192CS8	1253	LT1253CS8	1358	LT1358CS8	1442	LTC1442CS8
1193	LT1193CS8	1255	LTC1255CS8	1360	LT1360CS8	1442I	LTC1442IS8
1194	LT1194CS8	1255I	LTC1255IS8	1361	LT1361CS8	1446	LTC1446CS8
1195	LT1195CS8	1257	LTC1257CS8	1363	LT1363CS8	1446I	LTC1446IS8
1196I A	LTC1196-1ACS8	1257I	LTC1257IS8	1364	LT1364CS8	1446L	LTC1446LCS8
1196I B	LTC1196-1BCS8	1258	LTC1258CS8	1366	LT1366CS8	1446LI	LTC1446LIS8
11962A	LTC1196-2ACS8	12582	LTC1258CS8-2.5	1366I	LT1366IS8	1448	LTC1448CS8
11962B	LTC1196-2BCS8	12583	LTC1258CS8-3.0	1368	LT1368CS8	1448I	LTC1448IS8
1197	LTC1197CS8	12584I	LTC1258CS8-4.1	1372	LT1372CS8	1451	LTC1451CS8
1197I	LTC1197IS8	12585	LTC1258CS8-5	1372H	LT1372HVCS8	1451I	LTC1451IS8
1197L	LTC1197LCS8	1261	LTC1261CS8	1372HI	LT1372HVIS8	1452	LTC1452CS8
1197LI	LTC1197LIS8	12614	LTC1261CS8-4	1372I	LT1372IS8	1452I	LTC1452IS8
1198I A	LTC1198-1ACS8	126145	LTC1261CS8-4.5	1373	LT1373CS8	1453	LTC1453CS8
1198I B	LTC1198-1BCS8	1261L	LTC1261LCS8	1373H	LT1373HVCS8	1453I	LTC1453IS8
11982A	LTC1198-2ACS8	1261L4	LTC1261LCS8-4	1373HI	LT1373HVIS8	1456	LTC1456CS8
11982B	LTC1198-2BCS8	1262	LTC1262CS8	1373I	LT1373IS8	1456I	LTC1456IS8
1199	LTC1199CS8	1262I	LTC1262IS8	1374	LT1374CS8	1457	LT1457S8
1199I	LTC1199IS8	1263	LTC1263CS8	13745	LT1374CS8-5	1460A1	LT1460ACS8-10
1199L	LTC1199LCS8	1285	LTC1285CS8	1374HV	LT1374HVCS8	1460A2	LT1460ACS8-2.5
1199LI	LTC1199LIS8	12853	LTC1285CS-3.0	1374I	LT1374IS8	1460A5	LT1460ACS8-5
1200	LT1200CS8	1285I	LTC1285IS8	1374I5	LT1374IS8-5	1460D1	LT1460DCS8-10
1201	LT1201CS8	1286	LTC1286CS8	1374SN	LT1374CS8-SYNC	1460D2	LT1460DCS8-2.5
1203	LT1203CS8	1286I	LTC1286IS8	1375	LT1375CS8	1460D5	LT1460DCS8-5
1206	LT1206CS8	1288	LTC1288CS8	13755	LT1375CS8-5	1462	LT1462CS8

SURFACE MOUNT PRODUCTS

1462A	LT1462ACS8	1516	LTC1516CS8	16201	LT1620IS8	1842I	LTC1842IS8
1464	LT1464CS8	1516I	LTC1516IS8	1622	LTC1622CS8	1843	LTC1843CS8
1464A	LT1464ACS8	1521	LT1521CS8	1623	LTC1623CS8	1843I	LTC1843IS8
1466L	LT1466LCS8	15213	LT1521CS8-3	1623I	LTC1623IS8	1864	LTC1864CS8
1468	LT1468CS8	152133	LT1521CS8-3.3	1624	LTC1624CS8	1864I	LTC1864IS8
1468I	LT1468IS8	15215	LT1521CS8-5	1624I	LTC1624IS8	1865	LTC1865CS8
1470	LTC1470CS8	1521I	LT1521IS8	1627	LTC1627CS8	1865I	LTC1865IS8
1474	LTC1474CS8	1521I3	LT1521IS8-3	1627I	LTC1627IS8	1905	LT1019CS8-5
147433	LTC1474CS8-3.3	1521I33	LT1521IS8-3.3	1630	LT1630CS8	1910	LT1019CS8-10
14745	LTC1474CS8-5	1521I5	LT1521IS8-5	1632	LT1632CS8	1925	LT1019CS8-2.5
1474I	LTC1474IS8	1522	LTC1522CS8	1632A1	LT1634ACS8-1.25	1945	LT1019CS8-4.5
1474I5	LTC1474IS8-5	1522I	LTC1522IS8	1634A2	LT1634ACS8-2.5	2078	LT2078CS8
1475	LTC1475CS8	1530	LTC1530CS8	1634A4	LT1634ACS8-4.096	2078A	LT2078ACS8
147533	LTC1475CS8-3.3	1530I9	LTC1530CS8-1.9	1634A5	LT1634ACS8-5	2078AI	LT2078AIS8
14755	LTC1475CS8-5	153025	LTC1530CS8-2.5	1634B1	LT1634BCS8-1.25	2078I	LT2078IS8
1475I	LTC1475IS8	153028	LTC1530CS8-2.8	1634B2	LT1634BCS8-2.5	2105	LT1021DCS8-5
1477	LTC1477CS8	153033	LTC1530CS8-3.3	1634B4	LT1634BCS8-4.096	2107	LT1021DCS8-7
1480	LTC1480CS8	1530I	LTC1530IS8	1634B5	LT1634BCS8-5	2110	LT1021DCS8-10
1480I	LTC1480IS8	1536	LTC1536CS8	1635	LT1635CS8	2178	LT2178CS8
1481	LTC1481CS8	1536I	LTC1536IS8	1635I	LT1635IS8	2178A	LT2178ACS8
1481I	LTC1481IS8	1540	LTC1540CS8	1636	LT1636CS8	2178AI	LT2178AIS8
1482	LTC1482CS8	1540I	LTC1540IS8	1636I	LT1636IS8	2178I	LT2178IS8
1482I	LTC1482IS8	1541	LTC1541CS8	1638	LT1638CS8	234	LM234S8
1483	LTC1483CS8	1541I	LTC1541IS8	1638I	LT1638IS8	236AC1	LT1236ACS8-10
1483I	LTC1483IS8	1542	LTC1542CS8	1640H	LT1640HCS8	236AC5	LT1236ACS8-5
1484	LTC1484CS8	1542I	LTC1542IS8	1640HI	LT1640HIS8	236AI1	LT1236AIS8-10
1484I	LTC1484IS8	155041	LTC1550CS8-4.1	1640L	LT1640LCS8	236AI5	LT1236AIS8-5
1485	LTC1485CS8	1550L	LTC1550LCS8	1640LI	LT1640LIS8	236BC1	LT1236BCS8-10
1485I	LTC1485IS8	1550L2	LTC1550LCS8-2	1641	LT1641CS8	236BC5	LT1236BCS8-5
1487	LTC1487CS8	155141	LTC1551CS8-4.1	16471	LTC1647-1CS8	236BI1	LT1236BIS8-10
1487I	LTC1487IS8	1551L	LTC1551LCS8	16472	LTC1647-2CS8	236BI5	LT1236BIS8-5
1490	LT1490CS8	1551L2	LTC1551LCS8-2	1655	LTC1655CS8	236CC1	LT1236CCS8-10
1490I	LT1490IS8	155833	LTC1558CS8-3.3	1655I	LTC1655IS8	236CC5	LT1236CCS8-5
1492	LT1492CS8	15585	LTC1558CS8-5	1658	LTC1658CS8	236CI5	LT1236CIS8-5
1495	LT1495CS8	155933	LTC1559CS8-3.3	1658I	LTC1658IS8	236I1	LT1236CIS8-10
1495I	LT1495IS8	15595	LTC1559CS8-5	1659	LTC1659CS8	2400	LTC2400CS8
1497	LT1497CS8	15601	LTC1560-1CS8	1659I	LTC1659IS8	2400I	LTC2400IS8
1498	LT1498CS8	15601I	LTC1560-1IS8	1671	LT1671CS8	261L45	LTC1261LCS8-4.5
1501	LT1501CS8	1573	LT1573CS8	1671I	LT1671IS8	2851	LM285S8-1.2
150133	LT1501CS8-3.3	157325	LT1573CS8-2.5	1675I	LT1675-1CS8	2852	LM285S8-2.5
15015	LT1501CS8-5	157328	LT1573CS8-2.8	1675I1	LT1675-1IS8	318	LM318S8
1501I	LT1501IS8	157333	LT1573CS8-3.3	1676	LT1676CS8	326I25	LTC1326IS8-2.5
1501I3	LT1501IS8-3.3	1573I	LT1573IS8	1676I	LT1676IS8	334	LM334S8
1501I5	LT1501IS8-5	1575	LT1575CS8	168233	LTC1682CS8-3.3	3401	LT1034CS8-1.2
150233	LTC1502CS8-3.3	157515	LT1575CS8-1.5	16825	LTC1682CS8-5	3402	LT1034CS8-2.5
1504	LTC1504CS8	157528	LT1575CS8-2.8	1682I5	LTC1682IS8-5	34102	LT1034IS8-2.5
150433	LTC1504CS8-3.3	157533	LT1575CS8-3.3	1685	LTC1685CS8	3745SN	LT1374CS8-5 SYNC
1504A	LTC1504ACS8	157535	LT1575CS8-3.5	1686	LTC1686CS8	374HVI	LT1374HVIS8
1504AI	LTC1504AIS8	15755	LT1575CS8-5	1690	LTC1690CS8	374ISN	LT1374IS8-SYNC
1504I	LTC1504IS8	1576	LT1576CS8	1690I	LTC1690IS8	375HVI	LT1375HVIS8
1504I3	LTC1504IS8-3.3	1576I	LT1576IS8	16931	LTC1693-1CS8	376HVI	LT1376HVIS8
1506	LT1506CS8	1576SN	LT1576CS8-SYNC	16932	LTC1693-2CS8	3851	LM385S8-1.2
150633	LT1506CS8-3.3	1579	LT1579CS8	170619	LTC1706CS8-19	3851B	LM385BS8-1.2
1506I	LT1506IS8	15793	LT1579CS8-3	1710	LTC1710CS8	3852	LM385S8-2.5
1507	LT1507CS8	157933	LT1579CS8-3.3	1710I	LTC1710IS8	3852 B	LM385BS8-2.5
15073	LT1507CS8-3.3	15795	LT1579CS8-5	1719	LTC1719CS8	389A12	LT1389ACS8-1.25
1507I	LT1507IS8	1595A	LTC1595ACS8	1719I	LTC1719IS8	389B12	LT1389BCS8-1.25
1507I3	LT1507IS8-3.3	1595AI	LTC1595AIS8	1720	LT1720CS8	389B25	LT1389BCS8-2.5
1510	LT1510CS8	1595B	LTC1595BCS8	1720I	LT1720IS8	398	LF398S8
1510I	LT1510IS8	1595BI	LTC1595BIS8	1763	LT1763CS8	460B11	LT1460BIS8-10
1512	LT1512CS8	1595C	LTC1595CCS8	1776	LT1776CS8	460B12	LT1460BIS8-2.5
1512I	LT1512IS8	1595CI	LTC1595CIS8	1776I	LT1776IS8	460B15	LT1460BIS8-5
15143	LTC1514CS8-3	15I335	LTC1515IS8-3.3/5	1785	LT1785CS8	460E11	LT1460EIS8-10
151433	LTC1514CS8-3.3	1610	LT1610CS8	1785I	LT1785IS8	460E12	LT1460EIS8-2.5
15145	LTC1514CS8-5	1610I	LT1610IS8	1787	LT1787CS8	460E15	LT1460EIS8-5
1514I3	LTC1514IS8-3	1614	LT1614CS8	1787I	LT1787IS8	460LH5	LT1460LHS8-5
1514I5	LTC1514IS8-5	1614I	LT1614IS8	1813	LT1813CS8	460MH5	LT1460MHS8-5
1515	LTC1515CS8	1619	LT1619CS8	1841	LTC1841CS8	474I33	LTC1474IS8-3.3
151535	LTC1515CS8-3/5	1619I	LT1619IS8	1841I	LTC1841IS8	485	LTC485CS8
1515I	LTC1515IS8	1620	LT1620CS8	1842	LTC1842CS8	485I	LTC485IS8

SURFACE MOUNT PRODUCTS

490	LTC490CS8
490I	LTC490IS8
502I33	LTC1502IS8-3.3
504A33	LTC1504ACS8-3.3
506I33	LT1506IS8-3.3
514I33	LTC1514IS8-3.3
515335	LTC1515CS8-3.3/5
515I35	LTC1515IS8-3/5
530I19	LTC1530IS8-1.9
530I25	LTC1530IS8-2.5
530I28	LTC1530IS8-2.8
530I33	LTC1530IS8-3.3
550L25	LTC1550LCS8-2.5
550L41	LTC1550LCS8-4.1
551L25	LTC1551LCS8-2.5
551L41	LTC1551LCS8-4.1
573I25	LT1573IS8-2.5
573I28	LT1573IS8-2.8
573I33	LT1573IS8-3.3
576ISN	LT1576IS8-SYNC
60LH25	LT1460LHS8-2.5
60MH25	LT1460MHS8-2.5
634AI1	LT1634AIS8-1.25
634AI2	LT1634AIS8-2.5
634AI4	LT1634AIS8-4.096
634AI5	LT1634AIS8-5
634BI1	LT1634BIS8-1.25
634BI2	LT1634BIS8-2.5
634BI4	LT1634BIS8-4.096
634BI5	LT1634BIS8-5
660	LTC660CS8
682I33	LTC1682IS8-3.3
690	LTC690CS8
690I	LTC690IS8
692	LTC692CS8
692I	LTC692IS8
694	LTC694CS8
6943	LTC694CS8-3.3
694I	LTC694IS8
694I3	LTC694IS8-3.3
699	LTC699CS8
699I	LTC699IS8
706I19	LTC1706IS8-19
74I5SN	LT1374IS8-5 SYNC

8043E	LTC8043ES8
8043F	LTC8043FS8
941I	LT941IS8
947	LTC947CS8
954	LT954CS8
OP07	OP07CS8
OP27G	OP27GS8
OP37G	OP37GS8

SOT-23 MARK FULL PART NUMBER

1117	LT1117CST
11172	LT1117CST-2.85
11173	LT1117CST-3.3
11175	LT1117CST-5
111825	LT1118CST-2.5
111828	LT1118CST-2.85
11185	LT1118CST-5
11213	LT1121CST-3.3
11215	LT1121CST-5
1121I5	LT1121IST-5
1123	LT1123CST
11293	LT1129CST-3.3
11295	LT1129CST-5
11755	LT1175CST-5
1175I5	LT1175IST-5
121I3	LT1121IST-3.3
121I5	LT1121IST-5
129I3	LT1129IST-3.3
129I5	LT1129IST-5
152I3	LT1521CST-3
152I33	LT1521CST-3.3
152I5	LT1521CST-5
152I13	LT1521IST-3
152I133	LT1521IST-3.3
152I15	LT1521IST-5

3-Lead SOT-23 MARK FULL PART NUMBER

LTAC	LT1460HCS3-2.5
LTAD	LT1460JCS3-2.5
LTAE	LT1460KCS3-2.5
LTAK	LT1460HCS3-5
LTAL	LT1460JCS3-5

LTAM	LT1460KCS3-5
LTAN	LT1460HCS3-10
LTAP	LT1460JCS3-10
LTAQ	LT1460KCS3-10
LTAR	LT1460DIS3-5
LTAU	LT1460CCS3-10
LTAV	LT1460DCS3-10
LTAZ	LT1460DIS3-10
LTEV	LT1460CS3-2.5
LTEW	LT1460IS3-2.5
LTEX	LT1460CS3-3
LTEY	LT1460IS3-3

5-Lead SOT-23 MARK FULL PART NUMBER

LTCX	LTC1517CS5-5
LTED	LT1613CS5
LTEE	LTC1694CS5
LTEF	LT1517CS5-3.3
LTEP	LTC1663CS5
LTES	LT1611CS5
LTET	LT1611IS5

6-Lead SOT-23 MARK FULL PART NUMBER

LTFK	LTC1754CS6-5
------	--------------

16-Lead SSOP MARK FULL PART NUMBER

1067	LTC1067CGN
106750	LTC1067-50CGN
106751	LTC1067-50IGN
1067I	LTC1067IGN
1372	LT1372CGN
1372H	LT1372HVCGN
1372HI	LT1372HVIGN
1372I	LT1372IGN
1380	LTC1380CGN
1380I	LTC1380IGN
1393	LTC1393CGN
1393I	LTC1393IGN
1399	LT1399CGN
1399I	LT1399IGN

1430A	LTC1430ACGN
1430AI	LTC1430AIGN
1433	LTC1433CGN
1433I	LTC1433IGN
1473	LTC1473CGN
1473I	LTC1473IGN
1473L	LTC1473LCGN
1473LI	LTC1473LIGN
1510	LT1510CGN
1510I	LT1510IGN
15105	LT1510-5CGN
15105I	LT1510-5IGN
1512	LT1512CGN
1512I	LT1512IGN
1550	LTC1550CGN
1550I	LTC1550IGN
1550L	LTC1550LCGN
1550LI	LTC1550LIGN
1555	LTC1555CGN
1555I	LTC1555IGN
155833	LTC1558CGN-3.3
15585	LTC1558CGN-5
155933	LTC1559CGN-3.3
15595	LTC1559CGN-5
1579	LT1579CGN
15793	LT1579CGN-3
157933	LT1579CGN-3.3
15795	LT1579CGN-5
1579I	LT1579IGN
1579I3	LT1579IGN-3
1579I5	LT1579IGN-5
1620	LT1620CGN
1620I	LT1620IGN
1621	LT1621CGN
1621I	LT1621IGN
1643H	LTC1643HCGN
1643HI	LTC1643HVIGN
1643L	LTC1643LCGN
1643LI	LTC1643LIGN
1660	LTC1660CGN
1660I	LTC1660IGN
1675	LT1675CGN
579I33	LT1579IGN-3.3