

# NAiS

## GU (General Use) Type SOP Series 1- Channel (Form B) 4-Pin Type

# PhotoMOS RELAYS

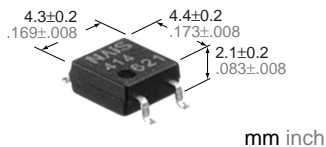

mm inch

## FEATURES

### 1. SO package 4-Pin type in super miniature design

The device comes in a super-miniature SO package 4-Pin type measuring (W) 4.3×(L) 4.4×(H) 2.1 mm (W) .169×(L) .173×(H) .083 inch —approx. 70% of the volume and 70% of the footprint size of SO package 6-pin type PhotoMOS Relays.

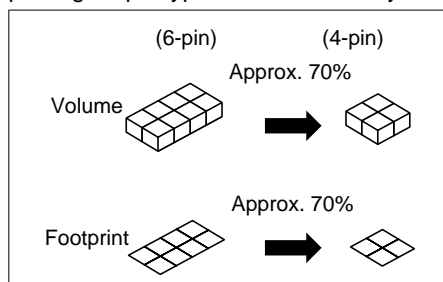

### 2. Low on resistance for normally-closed type

This has been realized thanks to the built-in MOSFET processed by our proprietary method, DSD (Double-diffused and Selective Doping) method.

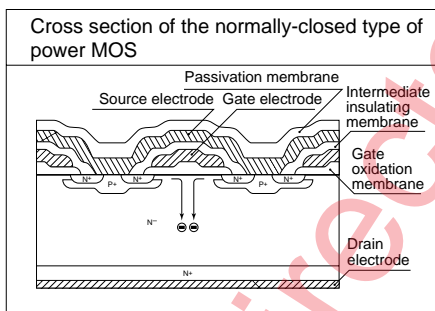

### 3. Tape and reel

The device comes standard in a tape and reel (1,000 pcs./reel) to facilitate automatic insertion machines.

### 4. Controls low-level analog signals

PhotoMOS relays feature extremely low closed-circuit offset voltage to enable control of low-level analog signals without distortion.

### 5. Low-level off state leakage current

In contrast to the SSR with an off state leakage current of several milliamps, the PhotoMOS relay features a very small off state leakage current of 1nA even with the rated load voltage of 350 V (AQY410S).

## TYPICAL APPLICATIONS

- Telecommunications (PC, Electronic Notepad)
- Measuring and Testing equipment
- Factory Automation Equipment
- Security equipment
- High speed inspection machines

## TYPES

### AC/DC type

Output rating*		Part No.		Packing quantity in tape and reel
Load voltage	Load current	Picked from the 1/2-pin side	Picked from the 3/4-pin side	
350 V	120 mA	AQY410SX	AQY410SZ	1,000 pcs.
400 V	100 mA	AQY414SX	AQY414SZ	

\* Indicate the peak AC and DC values.

Notes: (1) Tape package is the standard packing style. Also available in tube. (Part No. suffix "X" or "Z" is not needed when ordering; Tube: 100 pcs.; Case: 2,000 pcs.)

(2) For space reasons, the top two letters of the product number "AQY" and "S" are omitted on the product seal. The package type indicator "X" and "Z" are omitted from the seal. (Ex. the label for product number AQY414S is 414).

## RATING

### AC/DC type

1. Absolute maximum ratings (Ambient temperature: 25°C 77°F)

Item	Symbol	AQY410S	AQY414S	Remarks	
Input	LED forward current	$I_F$	50 mA		
	LED reverse voltage	$V_R$	3 V		
	Peak forward current	$I_{FP}$	1 A		
	Power dissipation	$P_{in}$	75 mW		
Output	Load voltage (peak AC)	$V_L$	350 V	400 V	
	Continuous load current (peak AC)	$I_L$	0.12 A	0.1 A	
	Peak load current	$I_{peak}$	0.3 A	0.24 A	100ms (1 shot), $V_L = DC$
	Power dissipation	$P_{out}$	300 mW		
Total power dissipation	$P_T$	350 mW			
I/O isolation voltage	$V_{iso}$	1,500 V AC			
Temperature limits	Operating	$T_{opr}$	-40°C to +85°C -40°F to +185°F		
	Storage	$T_{stg}$	-40°C to +100°C -40°F to +212°F		

# AQY410S

## 2. Electrical characteristics (Ambient temperature: 25°C 77°F)

Item		Symbol	AQY410S	AQY414S	Remarks
Input	LED operate (OFF) current	Typical	0.9 mA		I <sub>L</sub> = Max.
		Maximum	3 mA		
	LED reverse (ON) current	Minimum	0.4 mA		I <sub>L</sub> = Max.
		Typical	0.85 mA		
LED dropout voltage	Typical	1.14 V (1.25 V at I <sub>F</sub> = 50 mA)		I <sub>F</sub> = 5 mA	
	Maximum	1.5 V			
Output	On resistance	Typical	18 Ω	26 Ω	I <sub>F</sub> = 0 mA I <sub>L</sub> = Max. Within 1 s on time
		Maximum	25 Ω	35 Ω	
	Off state leakage current	Maximum	1 μA		
Transfer characteristics	Operate (OFF) time*	Typical	0.52 ms	0.47 ms	I <sub>F</sub> = 0 mA → 5 mA I <sub>L</sub> = Max.
		Maximum	1 ms		
	Reverse (ON) time*	Typical	0.23 ms	0.28 ms	I <sub>F</sub> = 5 mA → 0 mA I <sub>L</sub> = Max.
		Maximum	1 ms		
	I/O capacitance	Typical	0.8 pF		f = 1 MHz V <sub>B</sub> = 0
Maximum		1.5 pF			
Initial I/O isolation resistance	Minimum	R <sub>iso</sub>	1,000 MΩ		500 V DC

\*Operate/Reverse time

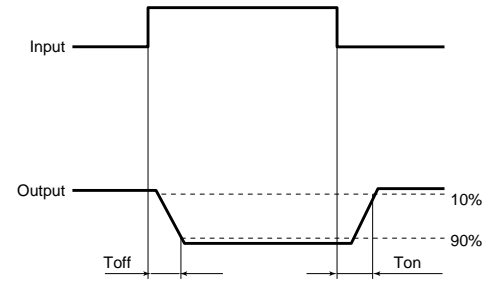

- For Dimensions, see Page 441.
- For Schematic and Wiring Diagrams, see Page 445.
- For Cautions for Use, see Page 449.

## REFERENCE DATA

### 1. Load current vs. ambient temperature characteristics

Allowable ambient temperature:  
-40°C to +85°C  
-40°F to +185°F

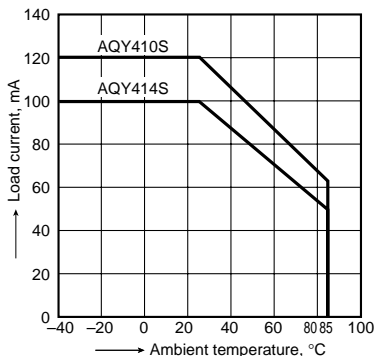

### 2. On resistance vs. ambient temperature characteristics

Measured portion: between terminals 3 and 4;  
LED current: 0 mA;  
Continuous load current: Max.(DC)

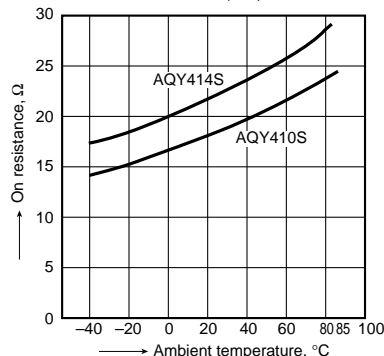

### 3. Operate (OFF) time vs. ambient temperature characteristics

LED current: 5 mA; Load voltage: Max.(DC);  
Continuous load current: Max.(DC)

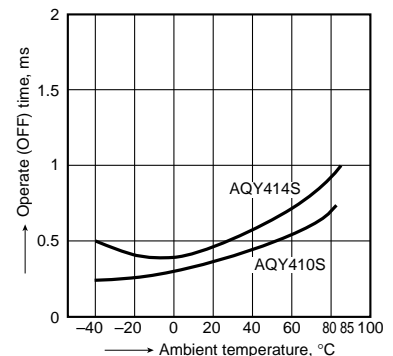

## 4. Reverse (ON) time vs. ambient temperature characteristics

LED current: 5 mA; Load voltage: Max.(DC); Continuous load current: Max.(DC)

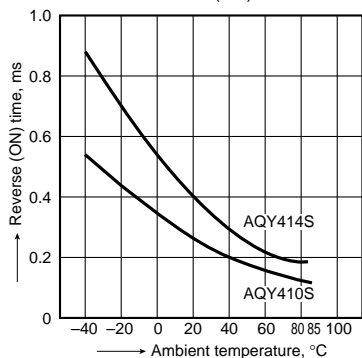

## 5. LED operate (OFF) current vs. ambient temperature characteristics

Load voltage: Max.(DC); Continuous load current: Max.(DC)

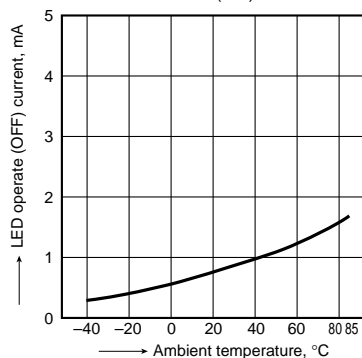

## 6. LED reverse (ON) current vs. ambient temperature characteristics

Load voltage: Max.(DC); Continuous load current: Max.(DC)

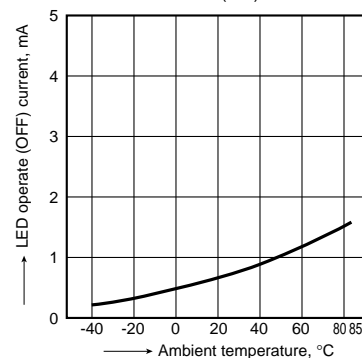

## 7. LED dropout voltage vs. ambient temperature characteristics

LED current: 5 to 50 mA

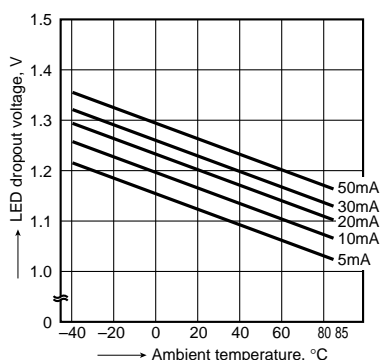

## 8. Voltage vs. current characteristics of output at MOS portion

Measured portion: between terminals 3 and 4; Ambient temperature: 25°C 77°F

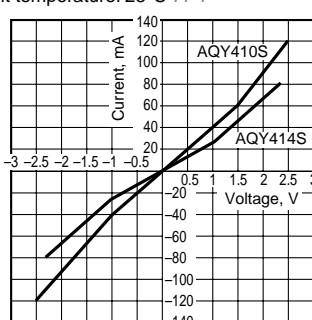

## 9. Off state leakage current

Measured portion: between terminals 3 and 4; LED current: 5 mA; Ambient temperature: 25°C 77°F

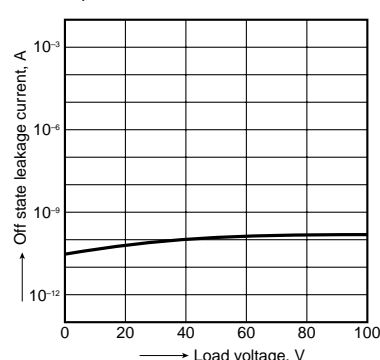

## 10. LED forward current vs. operate (OFF) time characteristics

Measured portion: between terminals 3 and 4; Load voltage: Max.(DC); Continuous load current: Max.(DC); Ambient temperature: 25°C 77°F

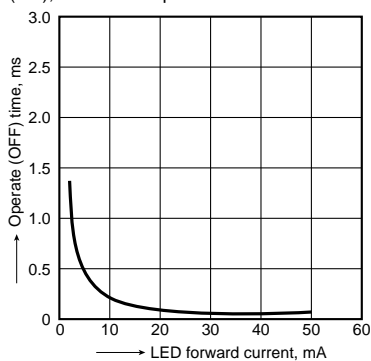

## 11. LED forward current vs. reverse (ON) time characteristics

Measured portion: between terminals 3 and 4; Load voltage: Max.(DC); Continuous load current: Max.(DC); Ambient temperature: 25°C 77°F

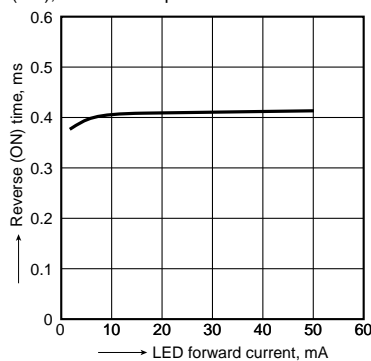

## 12. Applied voltage vs. output capacitance characteristics

Measured portion: between terminals 3 and 4; Frequency: 1 MHz; Ambient temperature: 25°C 77°F

