



# PHASE CONTROL SCR's

25 TO 35 AMPERES

GE TYPE	-	C230-2	C231-3	-	C228-9	C35	C38	-	C137	
JEDEC	2N681-92*	-	-	2N3870-3 2N3896-9	-	-	-	2N5204-7	-	
<b>ELECTRICAL SPECIFICATIONS</b>										
<b>VOLTAGE RANGE</b>		25-800	25-600	25-800	100-600	50-800	25-700	25-500	600-1200	500-1200
<b>FORWARD CONDUCTION</b>										
$I_{T(RMS)}$ Max. RMS on-state current (A)		25	25	25	35	35	35	35	35	35
$I_{T(AV)}$ Max. average on-state current @ 180° conduction (A) @ $T_C$ (°C)		16 @ 65°C	16 @ 70°C	16 @ 70°C	22.5 @ 65°C	20 @ 73°C	22.3 @ 35°C	22.5 @ 70°C	22.3 @ 40°C	22.3 @ 40°C
$I_{TSM}$ Max. peak one cycle, non-repetitive surge current (A)		150	300	300	350	300	150	150	300	350
$I^2 t$ Max. $I^2 t$ for fusing for ≥ 1.5 msec. (A <sup>2</sup> sec)		75	260	260	260	260	75	75	260	350
$V_{TM}$ Peak on-state voltage @ 25°C, 180° conduction, rated $I_{T(AV)}$ (V)		2.0	1.5	1.5	1.85	1.5	1.6	1.6	1.8	1.8
$R_{\theta JC}$ Max. internal thermal resistance, dc, junction-to-case (°C/W)		1.7	1.0	1.0	.9	1.7	1.7	1.5	1.5	1.0
$I_H$ Max. holding current @ 25°C (mA)		100	50	50	70	75	100	80	100	100
$t_a$ Typical turn-off time (μsec) at rated $T_J$ (max.)		-	-	-	40	-	-	26	-	-
$t_d + t_r$ Typical turn-on time (μsec)		1.6	3	3	2	-	1.6	1.6	1.6	1.6
$di/dt$ Max. rate-of-rise turned-on current (A/μsec)		80	20	20	100	-	80	80	150	150
$T_J$ Junction operating temperature range (°C)		-65 to 125	-40 to 100	-40 to 100	-40 to 100	-40 to 125	-65 to 125	-65 to 150	-40 to 125	-65 to 125
<b>BLOCKING</b>										
$dv/dt$ Typical critical rate-of-rise of off-state voltage, Exponential @ max. rated $T_J$ (V/μsec)		50	100	100	50	50	50	20	200	200
<b>FIRING</b>										
$I_{GT}$ Max. required gate current to trigger (mA) @ -65°C		80	-	-	-	-	80	80	-	80
	@ -40°C	-	40	20	80	80	-	-	80	-
	@ 25°C	40	25	9	40	40	40	40	40	40
$V_{GT}$ Max. required gate voltage to trigger (V) @ -65°C		3.0	-	-	-	-	3.0	3.0	-	3.0
	@ -40°C	-	2.0	2.0	3.0	3.0	-	-	3.0	-
	@ 25°C	3.0	1.5	1.5	2.0	2.5	3.0	3.0	3.0	3.0
$V_{GT}$ Min. required gate voltage to trigger @ 100°C		-	0.2	0.2	0.2	-	-	-	-	-
	@ 125°C	0.25	-	-	-	0.2	0.25	-	0.25	0.25
	@ 150°C	-	-	-	-	-	-	0.15	-	-
<b>VOLTAGE TYPES</b>										
<b>Repetitive Peak Forward and Reverse Voltages</b>										
25	2N681	C230/2U	C231/3U	-	C228/9U	C35U	C38U	-	-	
50	2N682*	C230/2F	C231/3F	-	C228/9F	C35F	C38F	-	-	
100	2N683*	C230/2A	C231/3A	2N3870 2N3896	C228/9A	C35A	C38A	-	-	
150	2N684	-	-	-	-	C35G	C38G	-	-	
200	2N685*	C230/2B	C231/3B	2N3871 2N3897	C228/9B	C35B	C38B	-	-	
250	2N686*	-	-	-	-	C35H	C38H	-	-	
300	2N687*	C230/2C	C231/3C	-	C228/9C	C35C	C38C	-	-	
400	2N688*	C230/2D	C231/3D	2N3872 2N3898	C228/9D	C35D	C38D	-	-	
500	2N689*	C230/2E	C231/3E	-	C228/9E	C35E	C38E	-	C137E	
600	2N690	C230/2M	C231/3M	2N3873 2N3899	C228/9M	C35M	-	2N5204	C137M	
700	2N691	-	-	-	-	C35S	-	-	C137S	
800	2N692	-	-	-	-	-	-	2N5205	C137N	
900	-	-	-	-	-	-	-	-	C137T	
1000	-	-	-	-	-	-	-	2N5206	C137P	
1100	-	-	-	-	-	-	-	-	C137PA	
1200	-	-	-	-	-	-	-	2N5207	C137PB	
<b>PACKAGE OUTLINE NO.</b>	107	241 (C232) 2, 3, 4, 5 & 6 (C230)	241 (C233) 2, 3, 4, 5 & 6 (C231)	241 242	251 (C229) 2, 3, 4, 5 & 6 (C228)	107	107	107	107	

\*JAN & JANTX types available.

The 2N5204-07 series of silicon controlled rectifiers are reverse blocking triode thyristor semiconductor devices for use in medium power switching and phase control applications requiring blocking voltage up to 1200 volts, and average load current (single-phase, 180° conduction angle) up to 22 amperes.

General Electric's C137 SCR is recommended where a higher level of performance is required for a device of this size.

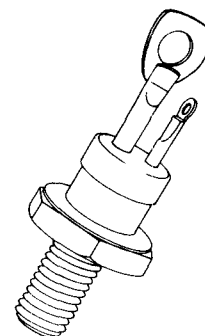

### MAXIMUM ALLOWABLE RATINGS

Type	Repetitive Peak Off-State Voltage, $V_{DRM}^{(1) (2)}$	Repetitive Peak Reverse Voltage $V_{RRM}^{(1) (2)}$	Non-repetitive Peak Reverse Voltage $V_{RSM}^{(1) (3)}$
	$T_C = -40^\circ\text{C to } +125^\circ\text{C}$	$T_C = -40^\circ\text{C to } +125^\circ\text{C}$	$T_C = -40^\circ\text{C to } +125^\circ\text{C}$
2N5204	600 Volts†	600 Volts†	720 Volts†
2N5205	800 Volts†	800 Volts†	960 Volts†
2N5206	1000 Volts†	1000 Volts†	1200 Volts†
2N5207	1200 Volts†	1200 Volts†	1440 Volts†

- (1) Values apply for gate terminal open-circuited. (Negative gate bias is permissible.)
- (2) Maximum case-to-ambient thermal resistance for which maximum  $V_{DRM}$  and  $V_{RRM}$  ratings apply equals 5.0°C per watt for full sine wave or full-wave rectified sinusoidal voltage waveform. (3.0°C per watt is maximum case-to-ambient thermal resistance for pure dc voltage waveform.)
- (3) Half sine wave voltage pulse, 10 millisecond maximum duration.
- (4) di/dt rating is established in accordance with EIA Standard RS-397, Section 5.2.2.6. Off-state (blocking) voltage capability may be temporarily lost immediately after each current pulse for duration less than the period of the applied pulse repetition rate. The pulse repetition rate for this test is 400 Hz. The duration of the JEDEC di/dt test condition is 5.0 seconds (minimum).

RMS On-State Current, $I_{T(RMS)}$ .....	35 Amperes (all conduction angles)
Average On-State Current, $I_{T(AV)}$ .....	Depends on conduction angle (See Charts 3 and 5)
Critical Rate-of-Rise of On-State Current, di/dt: (4)	
Gate triggered operation.....	(See Chart 6)
Switching from 1200 volts.....	75 Amperes per microsecond†
1000 volts.....	80 Amperes per microsecond†
800 volts.....	90 Amperes per microsecond†
600 volts.....	100 Amperes per microsecond†
Breakover voltage triggered operation.....	10 Amperes per microsecond
Peak One Cycle Surge (non-rep) On-State Current, $I_{TSM}$ .....	300 Amperes†
$I^2t$ (for fusing), for time = 1.0 milliseconds (See Chart 9).....	200 Ampere <sup>2</sup> seconds
for time = 8.3 milliseconds (See Chart 9).....	375 Ampere <sup>2</sup> seconds
Peak Gate Power Dissipation, $P_{GM}$ .....	60 Watts for 500 microseconds†
Average Gate Power Dissipation, $P_{G(AV)}$ .....	10 Watts†
Peak Negative Gate Voltage, $V_{GM}$ .....	5 Volts†
Storage Temperature, $T_{STG}$ .....	-40°C to +150°C†
Operating Temperature, $T_J$ .....	-40°C to +125°C†
Maximum Stud Torque.....	30 Lb-in (35 Kg-cm)

†Indicates data included on JEDEC Type Number Registration.

CHARACTERISTICS

Test	Symbol	Min.	Max.	Units	Test Conditions
Peak Off-State or Reverse Current (1)(2)  2N5204 2N5205 2N5206 2N5207	$I_{DRM}$ OR $I_{RRM}$	—	3.3† 2.5† 2.0† 1.7†	mA	$T_C = -40^\circ \text{ to } +125^\circ \text{C}$  $V_{DRM} = V_{RRM} = 600 \text{ Volts Peak}$ 800 1000 1200
D.C. Gate Trigger Current	$I_T$	—	40 80†	mAdc	$T_C = +25^\circ \text{C}, V_D = 12 \text{ Vdc}, R_L = 12 \text{ ohms}$ $T_C = -40^\circ \text{C}, V_D = 12 \text{ Vdc}, R_L = 12 \text{ ohms}$
D.C. Gate Trigger Voltage	$V_{GT}$	—	3.0 3.0† 0.25† —	Vdc	$T_C = +25^\circ \text{C}, V_D = 12 \text{ Vdc}, R_L = 12 \text{ ohms}$ $T_C = -40^\circ \text{C}, V_D = 12 \text{ Vdc}, R_L = 12 \text{ ohms}$ $T_C = +125^\circ \text{C}, \text{Rated } V_{DRM}, R_L = 1000 \text{ ohms}$
Peak On-State Voltage	$V_{TM}$	—	2.3†	Volts	$T_C = +25^\circ \text{C}, I_{TM} = 70 \text{ A peak}, 1 \text{ msec wide pulse. Duty cycle } \leq 2\%$ .
Holding Current	$I_H$	—	100 200†	mAdc	Anode supply = 24 Vdc, Gate supply = 10 V, 20 ohms. Initial Forward Current Pulse = 0.5 A, 0.1 to 10.0 msec. wide.  $T_C = +25^\circ \text{C}$ $T_C = -40^\circ \text{C}$
Critical Rate of Rise of Forward Blocking Voltage. (Higher values may cause device switching.)	dv/dt	100†	—	Volts/ $\mu$ sec	$T_C = +125^\circ \text{C}, \text{Rated } V_{DRM}, \text{Gate open circuited.}$
Thermal Resistance	$\theta_{J-C}$	—	1.5†	$^\circ \text{C/watt}$	Junction-to-case, dc

(1) Values apply for gate terminal open-circuited. (Negative gate bias is permissible.)

(2) Maximum case-to-ambient thermal resistance for which maximum  $V_{DRM}$  and  $V_{RRM}$  ratings apply equals  $5.0^\circ \text{C per watt}$  for full sine wave or full-wave rectified sinusoidal voltage waveform. ( $3.0^\circ \text{C per watt}$  is maximum case-to-ambient thermal resistance for pure dc voltage waveform.)

†Indicates data included on JEDEC Type Number Registration.

OUTLINE DRAWING

(COMPLIES WITH JEDEC TO-48)

NOTES:

- Complete threads to extend within  $2\frac{1}{2}$  threads of seating plane. Diameter of unthreaded portion .249" (6.32MM) Maximum, .220" (5.59MM) Minimum.
- Angular orientation of these terminals is undefined.
- $\frac{1}{4}$ -28 UNF-2A. Maximum pitch diameter of plated threads shall be basic pitch diameter .2268" (5.76MM), minimum pitch diameter .2225" (5.66MM), reference: screw thread standards for Federal Service 1957, Handbook H28, 1957, P1.
- A chamfer (or undercut) on one or both ends of hexagonal portions is optional.
- Case is anode connection.
- Large terminal is cathode connection.
- Small terminal is gate connection.
- Insulating kit available upon request.
- $\frac{1}{4}$ -28 steel nut, Ni. plated, .178 min. thk.
- Ext. tooth lockwasher, steel, Ni. plated, .023 min. thk.

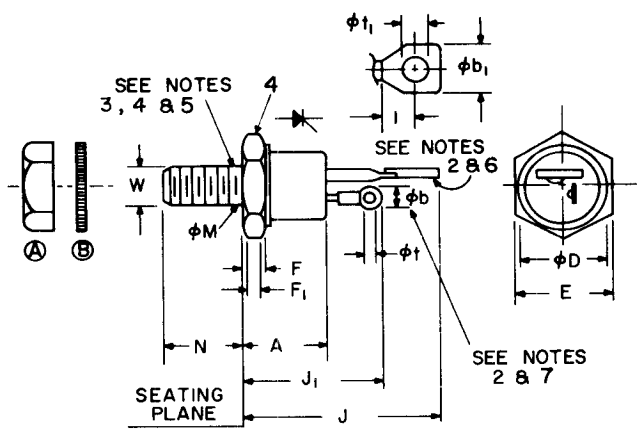

SYMBOL	INCHES		MILLIMETERS		NOTES
	MIN.	MAX.	MIN.	MAX.	
A	.330	.505	8.38	12.83	
$\phi_b$	.115	.140	2.92	3.56	2
$\phi_{b1}$	.210	.300	5.33	7.62	2
$\phi_D$		.544		13.82	
E	.544	.562	13.82	14.27	
F	.113	.200	2.87	5.08	4
$F_1$	.060		1.52		
J		1.193		30.30	
$J_1$		.875		22.23	
I	.120		3.05		
$\phi_M$					1
N	.422	.453	10.72	11.51	
$\phi_t$	.060	.075	1.52	1.91	
$\phi_{t1}$	.125	.165	3.18	4.19	
W					3

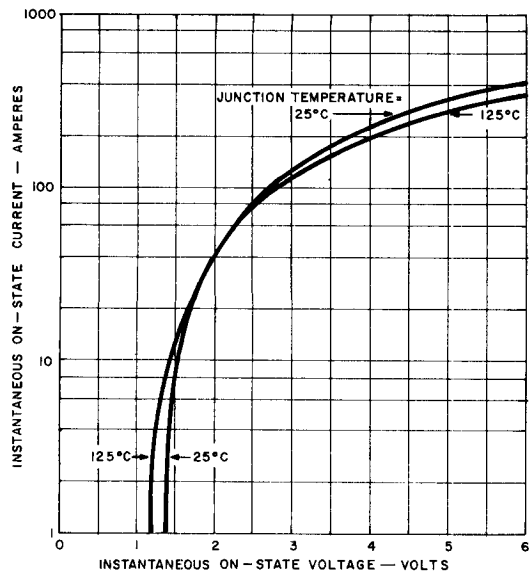

1. MAXIMUM ON-STATE CHARACTERISTICS

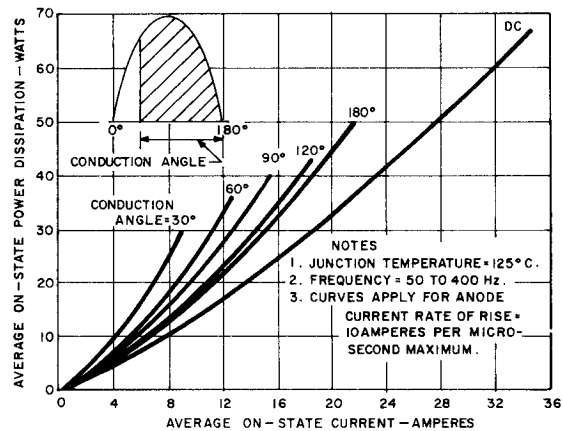

2. MAXIMUM ON-STATE POWER DISSIPATION FOR HALF-WAVE RECTIFIED SINE WAVE OF CURRENT

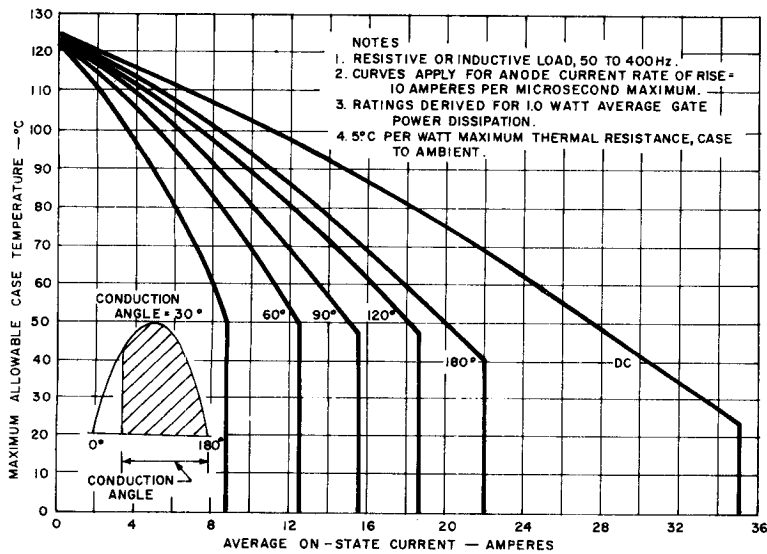

3. MAXIMUM ALLOWABLE CASE TEMPERATURE FOR HALF-WAVE RECTIFIED SINE WAVE OF CURRENT

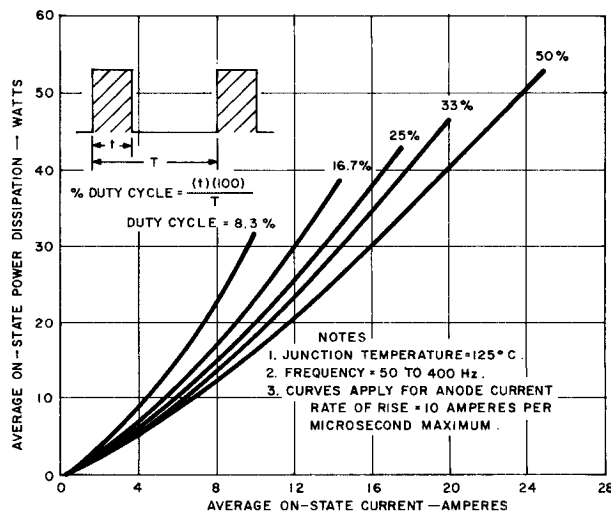

4. MAXIMUM ON-STATE POWER DISSIPATION FOR RECTANGULAR CURRENT WAVEFORM

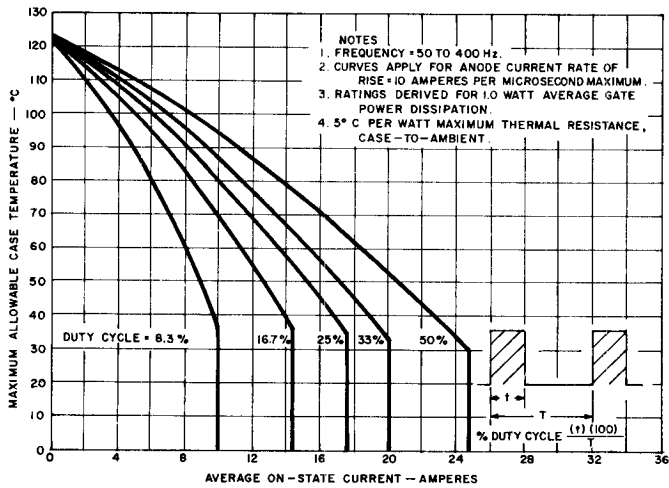

5. MAXIMUM ALLOWABLE CASE TEMPERATURE FOR RECTANGULAR CURRENT WAVEFORM

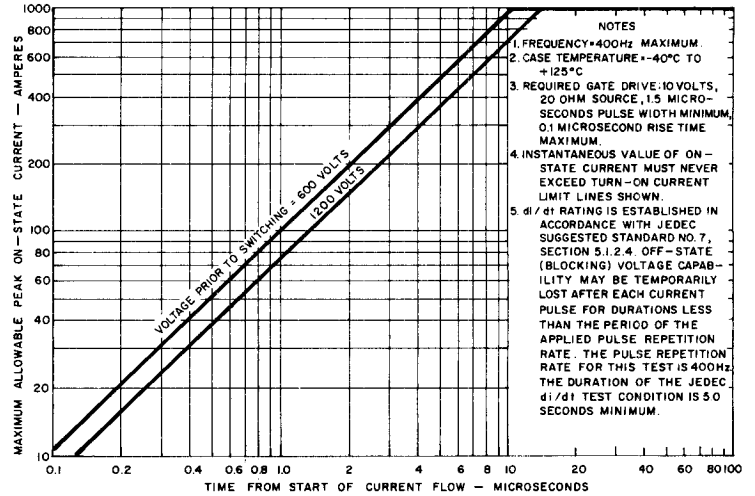

6. TURN-ON CURRENT LIMIT

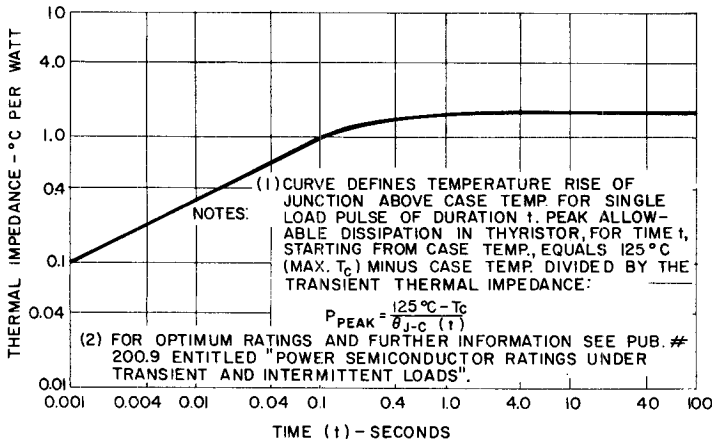

7. MAXIMUM TRANSIENT THERMAL IMPEDANCE, JUNCTION-TO-CASE

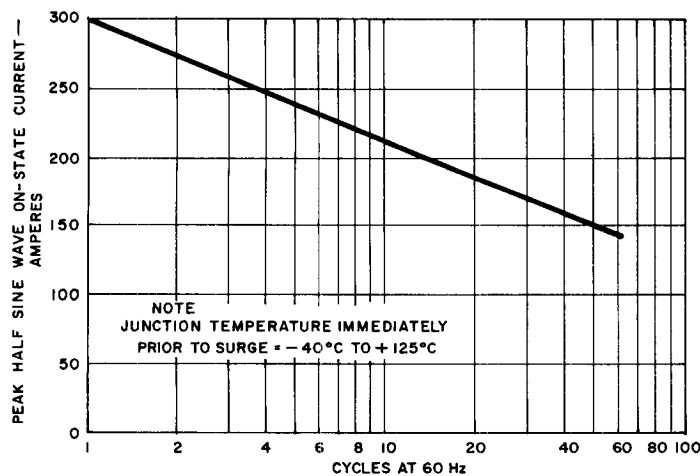

8. MAXIMUM ALLOWABLE SURGE (NON-REPETITIVE) ON-STATE CURRENT

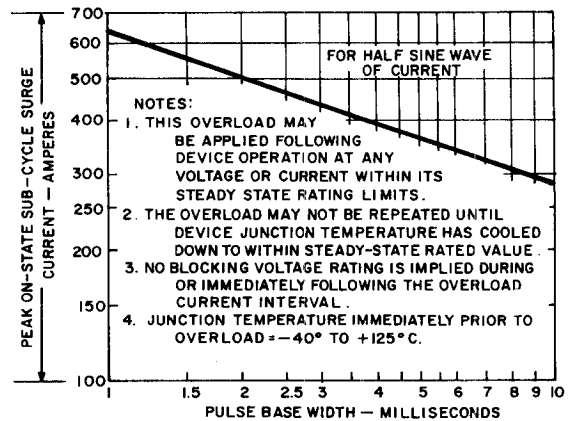
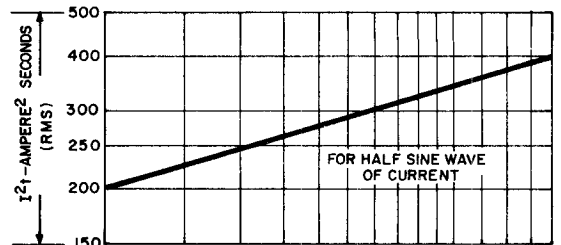

9. MAXIMUM ALLOWABLE SUB-CYCLE SURGE (NON-REPETITIVE) ON-STATE CURRENT AND I<sup>2</sup>T RATING