

Thermal Cutoffs (TCO)/ Thermal-Links

EYP Series: **N**
 Series: **F**
 Series: **E**
 Series: **H**
 Series: **MT**
 Series: **MS**

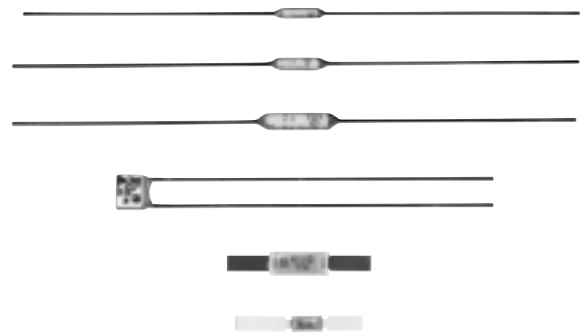

■ Features

- Small and Insulated Type
- High Reliability
- Solid Structure
- Non-Cadmium Alloy
- Taping type, Lead forming, Insulated lead, etc. available on special request
- Thin Type
 Thickness is less than 1 mm. Available for spot welding (MT and MS series)

■ Approved Safety Standards

-  (Japan) : Approved by JET
 - UL (U.S.A.) : E60271
 - CSA (Canada) : LR67163
 - VDE (Germany) : 4811. 6-1171-□□□□
 - BEAB (U.K.) : C□□□□
 - CCEE (China) : CH□□□□□□□□-□□□□
- See Ratings in details.

■ Recommended Applications

- Transformers, Solenoids, Ventilation fan, Electric fans, Small electric motors, Driers, Gas home appliances, Fluorescent lights, Electric shavers, AC Adaptors, Heating devices, ICs, Batteries, etc. The TCO can also be used for overheating protection.

■ Construction

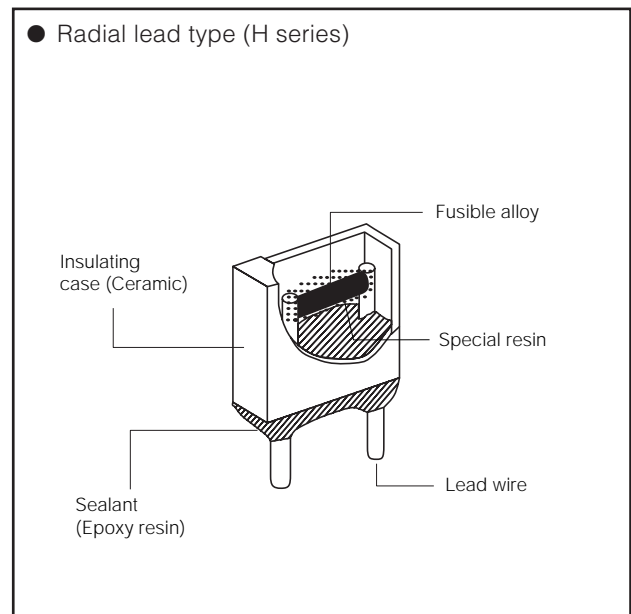
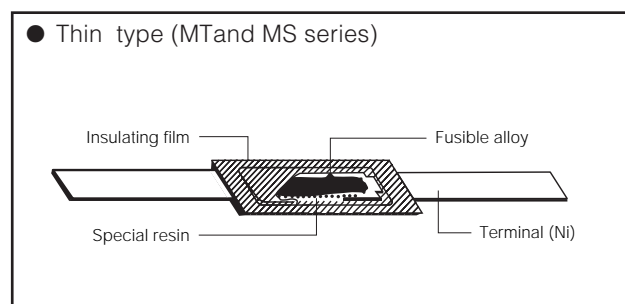
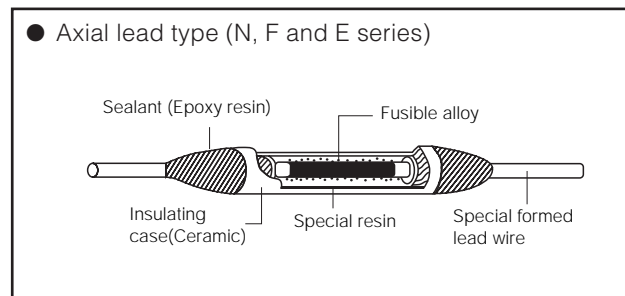

■ Ratings

● N series

Part No.	Type No. of Approved Standards	Rated Functioning Temp.*1 (°C)	Functioning Temp.*2 (°C)	Maximum Operating Temp.*3 (°C)	Holding Temp.*4 (°C)	Maximum Temp. Limit (°C)*5		Electrical Rating			Approved Safety Standards					Approved Safety Standards File No.	
						UL, VDE, BEAB	CSA	AC/DC	Amp. (A)	Volt. (V)	PE	UL	CSA	VDE	BEAB		CCEE
EYP2BN082	N082	86	82±2	52	56	200	150	AC	3	125		○	○	○	—	○	UL : E60271 CSA : LR67163 VDE : 4811.6-1171-0001 BEAB : C0736 CCEE : CH003627-99
				60	60			AC	2	250	○	○	○	○	○	○	
EYP2BN088	N088	92	88±2	45	50	200	—	DC	4	50		○	○	○	—	○	
				56	60			AC	3	125	○	○	—	—	—	—	
EYP2BN098	N098	102	98±2	62	65	200	150	DC	4	50		○	○	○	—	○	
				47	52			AC	3	125	○	○	○	○	—	○	
EYP2BN109	N109	114	110±3	65	70	200	150	AC	2	250	○	○	○	○	—	○	
				75	76			DC	4	50		○	○	○	○	—	
EYP2BN110	N110	115	110 ⁺³ ₋₂	76	86	200	150	AC	3	125		○	○	○	—	○	
				80	90			AC	2	250	○	○	○	○	—	○	
EYP2BN124	N124	130	126±2	65	74	200	180	DC	5	50		○	○	○	—	○	
				90	105			AC	3	125	○	○	○	○	—	○	
EYP2BN126	N126	133	128±2	94	105	200	180	AC	2	250	○	○	○	○	—	○	
				80	94			DC	5	50		○	○	○	—	○	
EYP2BN135	N135	140	136±3	92	108	200	180	AC	3	125		○	○	○	—	○	
				96	108			AC	2	250	○	○	○	○	—	○	
EYP2BN143	N143	145	141±2	82	96	200	180	DC	5	50		○	○	○	—	○	
				99	115			AC	3	125	○	○	○	—	○		
EYP2BN163	N163	168	163 ⁺² ₋₁	103	115	200	180	AC	2	250	○	○	○	○	—	○	
				80	90			DC	6	50		○	○	○	—	○	
EYP2BN183	N183	188	183 ⁺³ ₋₂	105	115	200	180	AC	3	125		○	○	○	—	○	
				110	120			AC	2	250	○	○	○	○	—	○	
EYP2BN163	N163	168	163 ⁺² ₋₁	80	90	200	180	DC	6	50		○	○	○	—	○	
				120	130			AC	3	125	○	○	○	○	—	○	
EYP2BN163	N163	168	163 ⁺² ₋₁	120	135	200	180	AC	2	250	○	○	○	○	—	○	
				90	100			DC	6	50		○	○	○	—	○	
EYP2BN183	N183	188	183 ⁺³ ₋₂	120	140	200	180	AC	3	125		○	○	○	—	○	
				120	140			AC	2	250	○	○	○	○	—	○	
EYP2BN183	N183	188	183 ⁺³ ₋₂	120	130	200	180	DC	6	50		○	○	○	—	○	
				120	130			DC	6	50		○	○	○	—	○	

Note: For long lead types, add letter "L" at the end of the part number.

● F series

Part No.	Type No. of Approved Standards	Rated Functioning Temp.*1 (°C)	Functioning Temp.*2 (°C)	Maximum Operating Temp.*3 (°C)	Holding Temp.*4 (°C)	Maximum Temp. Limit (°C)*5		Electrical Rating			Approved Safety Standards					Approved Safety Standards File No.	
						UL, VDE, BEAB	CSA	AC/DC	Amp. (A)	Volt. (V)	PE	UL	CSA	VDE	BEAB		CCEE
EYP1BF102	F102	102	98±2	70	74	200	150	AC	2	125		○	○	○	—	○	UL : E60271 CSA : LR67163 VDE : 4811.6-1171-0003 BEAB : C0738 CCEE : CH0066083-2001
				75	76			AC	1	250	○	○	○	○	○	○	
EYP1BF115	F115	115	110 ⁺³ ₋₂	55	60	200	150	DC	3.5	50		○	○	○	—	○	
				76	90			AC	2	125	○	○	○	○	—	○	
EYP1BF130	F130	130	126±2	80	90	200	180	AC	1	250	○	○	○	○	—	○	
				70	80			DC	4	50		○	○	○	—	○	
EYP1BF133	F133	133	128±2	90	105	200	180	AC	2	125		○	○	○	—	○	
				94	105			AC	1	250	○	○	○	○	—	○	
EYP1BF139	F139	139	135±3	74	90	200	180	DC	4.5	50		○	○	○	—	○	
				92	108			AC	2	125	○	○	○	—	○		
EYP1BF168	F168	168	163 ⁺² ₋₁	96	108	200	180	AC	1	250	○	○	○	○	—	○	
				76	92			DC	4.5	50		○	○	○	—	○	
EYP1BF139	F139	139	135±3	99	115	200	180	AC	2	125		○	○	○	—	○	
				103	115			AC	1	250	○	○	○	○	—	○	
EYP1BF168	F168	168	163 ⁺² ₋₁	80	95	200	180	DC	5	50		○	○	○	—	○	
				120	135			AC	2	125		○	○	○	—	○	
EYP1BF168	F168	168	163 ⁺² ₋₁	120	142	200	180	AC	1	250	○	○	○	○	—	○	
				95	110			DC	5	50		○	○	○	—	○	

Note: For long lead types, add letter "L" at the end of the part number.

● E series

Part No.	Type No. of Approved Standards	Rated Functioning Temp.*1 (°C)	Functioning Temp.*2 (°C)	Maximum Operating Temp.*3 (°C)	Holding Temp.*4 (°C)	Maximum Temp. Limit (°C)*5		Electrical Rating			Approved Safety Standards					Approved Safety Standards File No.			
						UL, VDE, BEAB	CSA	AC/DC	Amp. (A)	Volt. (V)		UL	CSA	VDE	BEAB		CCEE		
EYP05BE102	E102	102	98±2	70	78	200	150	AC	1.5	125	<input type="checkbox"/>	<input type="checkbox"/>	<input type="checkbox"/>	<input type="checkbox"/>	<input type="checkbox"/>	UL : E60271 CSA : LR67163 VDE : 4811.6-1171-0002 BEAB : C0739 CCEE : CH0066084-2001			
				75	80			AC	0.5	250	<input type="checkbox"/>	<input type="checkbox"/>	<input type="checkbox"/>	<input type="checkbox"/>	<input type="checkbox"/>				
				65	70			DC	3	50	<input type="checkbox"/>	<input type="checkbox"/>	<input type="checkbox"/>	<input type="checkbox"/>	<input type="checkbox"/>				
EYP05BE115	E115	115	110±2	76	93	200	150	AC	1.5	125	<input type="checkbox"/>	<input type="checkbox"/>	<input type="checkbox"/>	<input type="checkbox"/>	UL : E60271 CSA : LR67163 VDE : 4811.6-1171-0002 BEAB : C0739 CCEE : CH0066084-2001				
				80	95			AC	0.5	250	<input type="checkbox"/>	<input type="checkbox"/>	<input type="checkbox"/>	<input type="checkbox"/>			<input type="checkbox"/>		
				70	84			DC	3	50	<input type="checkbox"/>	<input type="checkbox"/>	<input type="checkbox"/>	<input type="checkbox"/>			<input type="checkbox"/>		
EYP05BE130	E130	130	126±2	90	112	200	180	AC	1.5	125	<input type="checkbox"/>	<input type="checkbox"/>	<input type="checkbox"/>	<input type="checkbox"/>			UL : E60271 CSA : LR67163 VDE : 4811.6-1171-0002 BEAB : C0739 CCEE : CH0066084-2001		
				94	112			AC	0.5	250	<input type="checkbox"/>	<input type="checkbox"/>	<input type="checkbox"/>	<input type="checkbox"/>				<input type="checkbox"/>	
				83	102			DC	3	50	<input type="checkbox"/>	<input type="checkbox"/>	<input type="checkbox"/>	<input type="checkbox"/>				<input type="checkbox"/>	
				70	81			DC	5	50	<input type="checkbox"/>	<input type="checkbox"/>	<input type="checkbox"/>	<input type="checkbox"/>				<input type="checkbox"/>	
EYP05BE133	E133	133	128±2	92	115	200	180	AC	1.5	125	<input type="checkbox"/>	<input type="checkbox"/>	<input type="checkbox"/>	<input type="checkbox"/>				UL : E60271 CSA : LR67163 VDE : 4811.6-1171-0002 BEAB : C0739 CCEE : CH0066084-2001	
				96	115			AC	0.5	250	<input type="checkbox"/>	<input type="checkbox"/>	<input type="checkbox"/>	<input type="checkbox"/>					<input type="checkbox"/>
				85	105			DC	3	50	<input type="checkbox"/>	<input type="checkbox"/>	<input type="checkbox"/>	<input type="checkbox"/>					<input type="checkbox"/>
EYP05BE139	E139	139	135±2	99	120	200	180	AC	1.5	125	<input type="checkbox"/>	<input type="checkbox"/>	<input type="checkbox"/>	<input type="checkbox"/>					UL : E60271 CSA : LR67163 VDE : 4811.6-1171-0002 BEAB : C0739 CCEE : CH0066084-2001
				103	120			AC	0.5	250	<input type="checkbox"/>	<input type="checkbox"/>	<input type="checkbox"/>	<input type="checkbox"/>					
				92	110			DC	3	50	<input type="checkbox"/>	<input type="checkbox"/>	<input type="checkbox"/>	<input type="checkbox"/>		<input type="checkbox"/>			
				80	90			DC	5	50	<input type="checkbox"/>	<input type="checkbox"/>	<input type="checkbox"/>	<input type="checkbox"/>		<input type="checkbox"/>			

Note: E130 and E139 are additionally approved for UL, on DC50V 5A
 For long lead types, add letter "L" at the end of the part number.

● H series

Part No.	Type No. of Approved Standards	Rated Functioning Temp.*1 (°C)	Functioning Temp.*2 (°C)	Maximum Operating Temp.*3 (°C)	Holding Temp.*4 (°C)	Maximum Temp. Limit (°C)*5		Electrical Rating			Approved Safety Standards					Approved Safety Standards File No.				
						UL, VDE, BEAB	CSA	AC/DC	Amp. (A)	Volt. (V)		UL	CSA	VDE	BEAB		CCEE			
EYP2BH102	H102	102	98±2	70	74	200	200	AC	3	125	<input type="checkbox"/>	<input type="checkbox"/>	<input type="checkbox"/>	<input type="checkbox"/>	UL : E60271 CSA : LR67163 VDE : 4811.6-1171-0004 BEAB : C0737 CCEE : CH0036085-2001					
				75	76			AC	2	250	<input type="checkbox"/>	<input type="checkbox"/>	<input type="checkbox"/>	<input type="checkbox"/>		<input type="checkbox"/>				
				65	70			DC	3.5	50	<input type="checkbox"/>	<input type="checkbox"/>	<input type="checkbox"/>	<input type="checkbox"/>		<input type="checkbox"/>				
EYP2BH115	H115	115	110±2	76	86	200	200	AC	3	125	<input type="checkbox"/>	<input type="checkbox"/>	<input type="checkbox"/>	<input type="checkbox"/>		UL : E60271 CSA : LR67163 VDE : 4811.6-1171-0004 BEAB : C0737 CCEE : CH0036085-2001				
				80	90			AC	2	250	<input type="checkbox"/>	<input type="checkbox"/>	<input type="checkbox"/>	<input type="checkbox"/>			<input type="checkbox"/>			
				74	84			DC	3.5	50	<input type="checkbox"/>	<input type="checkbox"/>	<input type="checkbox"/>	<input type="checkbox"/>			<input type="checkbox"/>			
EYP2BH130	H130	130	126±2	90	105	200	200	AC	3	125	<input type="checkbox"/>	<input type="checkbox"/>	<input type="checkbox"/>	<input type="checkbox"/>			UL : E60271 CSA : LR67163 VDE : 4811.6-1171-0004 BEAB : C0737 CCEE : CH0036085-2001			
				94	105			AC	2	250	<input type="checkbox"/>	<input type="checkbox"/>	<input type="checkbox"/>	<input type="checkbox"/>				<input type="checkbox"/>		
				86	100			DC	3.5	50	<input type="checkbox"/>	<input type="checkbox"/>	<input type="checkbox"/>	<input type="checkbox"/>				<input type="checkbox"/>		
EYP2BH133	H133	133	128±2	92	108	200	200	AC	3	125	<input type="checkbox"/>	<input type="checkbox"/>	<input type="checkbox"/>	<input type="checkbox"/>				UL : E60271 CSA : LR67163 VDE : 4811.6-1171-0004 BEAB : C0737 CCEE : CH0036085-2001		
				96	108			AC	2	250	<input type="checkbox"/>	<input type="checkbox"/>	<input type="checkbox"/>	<input type="checkbox"/>					<input type="checkbox"/>	
				88	102			DC	3.5	50	<input type="checkbox"/>	<input type="checkbox"/>	<input type="checkbox"/>	<input type="checkbox"/>					<input type="checkbox"/>	
EYP2BH139	H139	139	135±2	99	115	200	200	AC	3	125	<input type="checkbox"/>	<input type="checkbox"/>	<input type="checkbox"/>	<input type="checkbox"/>					UL : E60271 CSA : LR67163 VDE : 4811.6-1171-0004 BEAB : C0737 CCEE : CH0036085-2001	
				103	115			AC	2	250	<input type="checkbox"/>	<input type="checkbox"/>	<input type="checkbox"/>	<input type="checkbox"/>						<input type="checkbox"/>
				95	107			DC	3.5	50	<input type="checkbox"/>	<input type="checkbox"/>	<input type="checkbox"/>	<input type="checkbox"/>						<input type="checkbox"/>
EYP2BH168	H168	168	163±3	120	135	200	200	AC	3	125	<input type="checkbox"/>	<input type="checkbox"/>	<input type="checkbox"/>	<input type="checkbox"/>	UL : E60271 CSA : LR67163 VDE : 4811.6-1171-0004 BEAB : C0737 CCEE : CH0036085-2001					
				120	142			AC	2	250	<input type="checkbox"/>	<input type="checkbox"/>	<input type="checkbox"/>	<input type="checkbox"/>						<input type="checkbox"/>
				120	135			DC	3.5	50	<input type="checkbox"/>	<input type="checkbox"/>	<input type="checkbox"/>	<input type="checkbox"/>						<input type="checkbox"/>

Panasonic

● MT series

Part No.	Type No. of Approved Standards	Rated Functioning Temp.*1 (°C)	Functioning Temp.*2 (°C)	Maximum Operating Temp.*3 (°C)	Holding Temp.*4 (°C)	Maximum Temp. Limit (°C)*5	Electrical Rating			Approved Safety Standards		Approved Safety Standards File No.
							AC/DC	Amp. (A)	Volt. (V)	UL	VDE	
EYP2MT092	MT092	92	89±2	55	60	150	DC	2	50	○	○	UL : E60271 VDE :4811.6-1171-0008
EYP2MT098	MT098	98	94±2	60	65	150	DC	2	50	○	○	
EYP2MT102	MT102	102	98±2	65	70	150	DC	2	50	○	○	

● MS series

Part No.	Type No. of Approved Standards	Rated Functioning Temp.*1 (°C)	Functioning Temp.*2 (°C)	Maximum Operating Temp.*3 (°C)	Holding Temp.*4 (°C)	Maximum Temp. Limit (°C)*5	Electrical Rating			Approved Safety Standards		Approved Safety Standards File No.
							AC/DC	Amp. (A)	Volt. (V)	UL	VDE	
EYP2MS092B	MS092B	92	89±2	55	60	150	DC	2	50	○	○	UL : E60271 VDE :4811.6-1171-0007
EYP2MS098B	MS098B	98	94±2	60	65	150	DC	2	50	○	○	

Note: For long types, add letter "L" at the end of the part number.

*1 Rated Functioning Temperature (UL: TF, CSA,VDE, BEAB, CCEE: Tf)

The temperature at which a TCO changes its state of conductivity to open circuit with loading detection current only.

Tolerance; $\pm 7^\circ\text{C}$

UL,CSA,VDE, BEAB, CCEE; $\pm 10^\circ\text{C}$

*2 Functioning Temperature (Fusing-off temperature)

The functioning temperature at which a TCO changes its state of conductivity to open circuit in the ambient air oven which increases temperature by 1 °C per minute and with loading the detective current 0.1 A or less.

*3 Maximum Operating Temperature.

The maximum temperature at which a TCO can be maintained while conducting rated current for 3000 h (N, F, E, H series) or 1000 h (MT, MS series) For details please refer to derivery specification.

*4 Holding Temperature (UL: TH, CSA: Th, VDE, BEAB, CCEE: Tc)

The maximum temperature at which a TCO can be maintained while conducting rated current for 168 h which will not cause a change in state of conductivity to open circuit.

*5 Maximum Temperature Limit (UL: TM, CSA,VDE, BEAB, CCEE: Tm)

The maximum temperature at which a TCO can maintains its mechanical and electrical properties without closing again for 10 minutes after a TCO has changed its state of conductivity.

■ Dimensions in mm (not to scale)

● Axial lead type

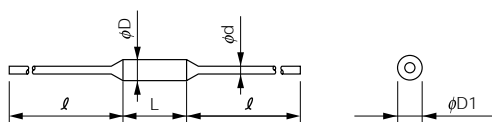

	Dimensions (mm)				
	L	ϕD	$\phi D1$	l	ϕd
N Series	9.0±1.0	2.5±0.2	3 max.	38±3 (*78±3)	0.60±0.05
F Series	6.0±1.0	1.85 $^{+0.20}_{-0.15}$	2.2 max.	38±3 (*68±3)	0.53±0.02
E Series	5.0±0.5	1.5±0.1	1.8 max.	38±3 (*68±3)	0.53±0.02

● Radial lead type

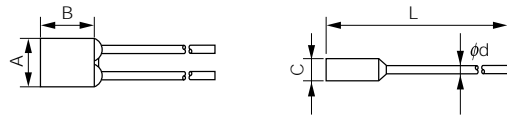

	Dimensions (mm)				
	A	B	C	L	ϕd
H Series	5.0±0.5	4.0±0.5	2.2±0.3	55±3	0.53±0.02

(*) Long lead type

● Thin type

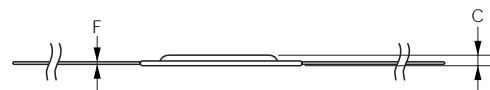
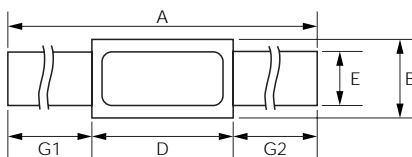

	Dimensions (mm)							
	A	B	C	D	E	F	G1	G2
MT Series	26.5±0.5	4.5±0.4	0.75±0.20	11.0 $^{+0.6}_{-0.4}$	3.0±0.2	0.15±0.02	7.7±0.5	7.7±0.5
MS Series	24.5±0.5 (*32.0±0.3)	3.0±0.3 (*3.6±0.2)	0.75±0.20	5.5±0.5 (*8.1 $^{+0.3}_{-0.1}$)	3.0±0.2	0.15±0.02	8.0±0.5 (*9.7±0.2)	11.0±0.5 (*14.2±0.2)

(*) Long type

Design, Specifications are subject to change without notice. Ask factory for technical specifications before purchase and/or use. Whenever a doubt about safety arises from this product, please inform us immediately for technical consultation without fail.

■ Marking

The following items are indicated on TCO.

- N, F, E, H Series : Type No., Date Code, M Mark(☒), <PS>E Mark, Rated Functioning Temperature, Rated Current
- MT, MS Series : Type No., Date Code, M Mark(☒)

■ Standard Taping Specifications

EYP2B□□□□V

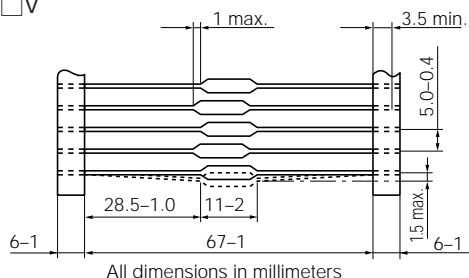

BOX

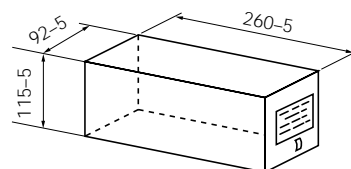

Standard Quantity : 4000 pcs.

■ Packing Specifications

Part No.	Standard Quantity	Style	Weight/pc. (mg)
EYP2BN□□□□	100 pcs./Bag	Bulk	340
EYP2BN□□□□L			510
EYP1BF□□□□			220
EYP1BF□□□□L			330
EYP05BE□□□□			210
EYP05BE□□□□L			320
EYP2BH□□□□			350
EYP2BN□□□□V	4000 pcs./Box	Flat Box	340
EYP2MT□□□□□	200 pcs./Bag	Bulk	130
EYP2MS□□□□□			95
EYP2MS□□□□□L			130

⚠ Safety Precautions (Handling Precautions)

● Design Applications

1. Use TCO within their specified temperature and electrical ratings.
 - 1) Use the TCO under an ambient temperature of not more than the maximum operating temperature specified in the individual specification.

Using the TCO under a higher temperature than the maximum operating temperature may cause premature opening or opening delay.

 - When the TCO is continuously used at the temperature close to the functioning temperature, the TCO may operate while being used.
 - When the TCO is continuously used at the temperature higher than the maximum operation temperature, the TCO may be degraded and may not operate normally at the specified temperature
 - 2) The holding temperature is defined as the highest temperature at which the TCO is activated continuously at the rated current for 168 hours. The TCO can not be used over 168 hours exceeding the holding temperature.
 - 3) Equipment should be designed so that its over shoot does not exceed the maximum temperature limit after the TCO operates.
 - 4) If the TCO is activated by voltage higher than the rated voltage or current higher than the rated current, the TCO produces excessive heat, resulting in premature opening. The arc generated at this condition of operation will result in an abnormality of appearance (crack on body) and insufficient insulation.
 - When TCO is operated in an abnormal mode while the rated voltage and/or the rated current being exceeded, it may not cut off the circuit.
 - 5) Where transient overload is expected to be applied, repeat the tests under the worst conditions.
 - 6) The TCO cannot be used as a current sensitive fuse.
2. To fully use the function of the TCO, a suitable TCO for each equipment application must be selected.
 - 1) Tests should be repeated for the finished equipment to confirm that the TCO does operate as expected.
 - 2) To improve thermal response of the TCO, put the main body of the TCO and the lead wires (terminals) as close to the heat source as possible and the place where the TCO is evenly heated.

If the temperatures transferred to the main body and to the lead wires (terminals) are largely different from each other, improper operation can be expected, causing arcing and deterioration of insulation.
 3. Avoid application of excessive vibration and mechanical stress to the TCO. Otherwise, failure of the fusible alloy or lead wires, or damage to the main body may result.
 4. When sealing the TCO with resin, select a resin that does not corrode the seals or the lead wires (terminals). When sealing the overall TCO with resin, test repeatedly to confirm normal operation of the TCO in the finished equipment.
 5. Avoid dipping the equipment with the TCO into varnish or chemical or organic solvent and then drying it. The solvent or the varnish may corrode the body and/or lead wires (terminals) of the TCO.
 6. Do not use under the following environments.
 - 1) In liquids such as water, oil, chemical and organic solvents
 - 2) Under direct sunlight and outdoor and dusty atmospheres
 - 3) In places where water condensation occurs.
 - * Use in the following environments may affect the performance of the TCO; Verify performance and reliability before production use.
 - (1) In places full of corrosive gases such as sea breeze, Cl₂, H₂S, NH₃, SO₂ and NO₂
 - (2) In environments with high static electricity and/or strong electromagnetic waves.
 - * Do not use the TCO in aerospace equipment, atomic energy equipment, military weapons, life saving equipment, etc.

● Instruction

7. Forming and Cutting
 - 1) Lead wires (terminals) are to be bent or cut at least 3 mm away from the TCO seals to avoid damaging the TCO. (axial / radial type) or body (thin type). The TCO seals (axial / radial type) shall not be grasped with any tools or holders. Terminals of thin type TCO are to be grasped before they are bent. (See Fig.1)
 - 2) The lead wires and terminals shall not be nicked, fractured or bumed.

The body and/or seals must not be damaged, burned or overheated.
 - 3) It is recommended that experimental assembly trials, should be done so that it can be verified that manufacturing procedures will not exceed the maximum tested "pull" and "push" forces of 20 N (MT series: 10 N, MS series: 5 N) and 5 N respectively on the lead wires (terminals), or induce excessive twisting or the like.

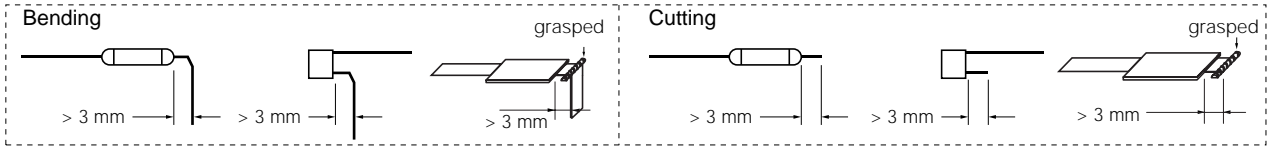

Fig-1

8. Soldering, Welding, Encapsulation

- 1) Lead wires are to be soldered with the standard conditions shown in Table 1. Excessive soldering heat and soldering time may cause damage to a TCO. If higher temperature, longer time or shorter lead length exist rather than the conditions of Table 1, it is recommended to run tests for finding the soldering conditions that do not damage the TCO. Also, use of tools such as pliers are recommended to dissipate the soldering heat by grasping lead wires between the TCO body and soldering point.
- 2) Avoid preheating and gradual cooling as far as possible. However, if preheating and gradual cooling is done, set the process conditions after confirming that the TCO is not affected by these procedures.
- 3) Do not use reflow soldering.
- 4) Thin type (MT, MS series) is not to be soldered.
- 5) If water or solvent is used for cleaning flux after soldering, check and confirm the reliability of the agent.
- 6) Lead wires are to be clamped at least 3 mm away from the seals. Improper connections may cause damage to the seals or other parts and may result in nuisance tripping of the devices due to the generation of excessive heat at a faulty high resistance junction.
- 7) Set the conditions for welding and encapsulation only after checking contact resistance and connection strength.
- 8) When resoldering or rewelding, cool the TCO under room conditions.
- 9) When the TCO is heated by soldering or welding, be careful not to pull, push or twist the TCO lead wires.

Table-1 Soldering Conditions

Temperature of Soldering: 300 °C Time: 3 s				
Lead Length (ℓ)	Type No.			
25 mm	N082, N088	F102	E102, E115	H102, H115
20 mm	N098, N109	F115, F130	E130, E133	H130, H133
	N110	F133, F139	E139	H139
15 mm	N124, N126	F168		H168
	N135, N143			
10 mm	N163, N183			

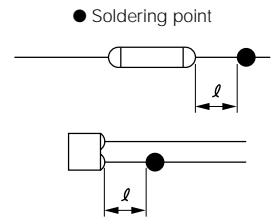

- 9 . The use of sufficiently flexible, appropriate free length and proper size wire should be used for splice connection. Connection including connectors used for splicing shall be of the low resistance type, and they shall be made mechanically secure.
10. Where the lead wires of the TCO is tied with string, put them at least 10 mm apart from the seals of the main body of the TCO.
11. Quality control notes:
 - 1) Measurement of resistance between lead wires (terminals) and checking of the internal status with X-rays are effective means to confirm the status of the TCO on delivery and after mounting in the equipment.
 - 2) It is necessary to confirm normal operation of the TCO with trial units and with a prototype equipment lot set at normal and abnormal conditions.
12. Storage method
 - 1) Store the TCO in packing cases or in polyethylene bags within the temperature range -10 °C to +40 °C and RH of 30 % to 75 %. Store them at a location where no rapid changes of temperature or humidity or no direct sunlight is applied. The location must also be free from vibration and shock.
 - 2) Avoid storage in places containing corrosive gases such as sea breeze, Cl₂, H₂S, NH₃, SO₂ and NO₂.
 - 3) The period of guarantee for performance such as solderability is for 1 year after our delivery; and this condition applies only in the case where the storage method specified in above has been followed.
13. Do not repair a TCO. Replace it with a new part.

Note: This catalog shows the quality and performance of a unit component. For quality assurance, contact us with your requirements. Before using, be sure to evaluate and verify the product after mounting it in your product.