

NOTES:

- [1] 4 DIGIT DATE CODE, AND CATALOG No. LOCATED APPROXIMATELY AS SHOWN.
- [2] STEP 5 DOES NOT APPLY TO 84 & 88 SERIES. OMIT STEP 5 ON CATALOG No..
- [3] STEP 6 \bullet = 2 DOES NOT APPLY TO 166 SERIES.
- [4] SERIES:
84 SERIES FOR SMALL C PRESS® WITH $\phi 0.032 \pm .003/0.81 \pm 0.08$ P.T.H
88 SERIES FOR STANDARD C PRESS® WITH $\phi 0.040 \pm .003/1.02 \pm 0.08$ P.T.H
166 SERIES FOR SOLDER TAIL WITH $\phi 0.040 \pm .003/1.02 \pm 0.08$ P.T.H
- [5] 166 SERIES TAILS ARE .1010/0.254 X .017/0.432 IN LENGTHS OF .125/3.17 AND .170/4.32.
- [6] INSULATOR AVAILABLE IN BLACK WHEN UTILIZING 166 SERIES DEVIATION 4338.
- [7] AVAILABLE FOR 84 SERIES RECEPTACLE ONLY.
- [8] CUSTOMER TOOLING:

TOOLS		
84R SERIES TOOLING		
DESCRIPTION	CATALOG No.	
INSERTION TOOL	14 POSITION	107-43604-01
	24 POSITION	107-43604-02
	36 POSITION	107-43604-03
	50 POSITION	107-43604-04
CONTACT REMOVAL TOOL	N/A	107-43929
SINGLE CONTACT KNOCK-OUT	N/A	107-42456
INSULATOR REMOVAL	14 & 24 POSITION	107-25875
	36 & 50 POSITION	107-25876

- [9] ADD DEVIATION No. 5422 TO CATALOG No. IF YOU WANT TO HAVE DUST COVERS BULK PACKAGED.
- [10] FOR PLATED THRU HOLE SPECIFICATION SEE DRAWING 27331 FOR $\phi 0.040/1.02$ P.T.H. & DRAWING 27367 FOR $\phi 0.032/0.81$ P.T.H.

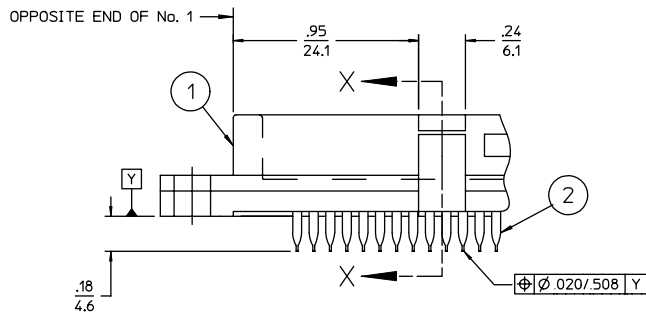

RECEPTACLE WITH VIBRATION LOCKS SHOWN [7][8]

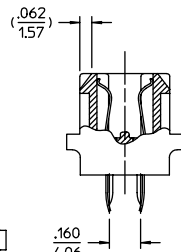

PARTIAL SECTION X-X

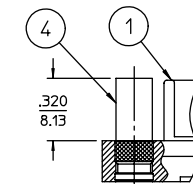

STANDOFF OPTION [3]
FOR 84 & 88 SERIES
 \bullet = 1

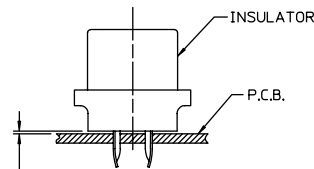

AFTER ASSEMBLY INTO P.C.B. INSULATOR TO BE FLUSH TO .015/.381 MAX ABOVE P.C.B. SURFACE

ORDERING CHART

SPECIFY COMPLETE CONNECTOR BY FOLLOWING INDICATED STEPS

[4] STEP 1 CODE

84 SERIES
88 SERIES
166 SERIES

STEP 2 GRID
INSULATORS FOR .085/2.16 X .160/4.06 GRID ARE BLACK IN COLOR

CODE	DESCRIPTION
11	.085/2.16 X .151/3.83 (PLUG) .085/2.16 X .169/4.29 (RECEPTACLE)
12	.085/2.16 X .160/4.06 (P & R)

STEP 3 No. OF CONTACT PAIRS

14	24
36	50

STEP 4 INSULATOR

CODE	DESCRIPTION
P	PLUG
R	RECEPTACLE
V	RECEPTACLE WITH VIBRATION LOCKS [7]

STEP 7 CONTACT PLATING

PLATING CODE	DESCRIPTION	DESCRIPTION
D	30 MICROINCHES GOLD OVER 50 MICROINCHES NICKEL ON CONTACT AREA WITH BRIGHT TIN ON THE C-SECTION	NON- RoHS
C	30 MICROINCHES GOLD OVER 50 MICROINCHES NICKEL ON CONTACT AREA WITH GOLD FLASH ON THE C-SECTION	RoHS
H	30 MICROINCHES GOLD OVER 50 MICROINCHES NICKEL ON CONTACT AREA WITH PURE TIN ON THE C-SECTION	RoHS

STEP 6 INSERTS

CODE	DESCRIPTION
0	NO INSERT
1	#4-40 FLUSH INSERT
2	#4-40 STANDOFF
3	#4-40 TAPPED HOLES [3]

STEP 5 CONTACT TAIL LENGTH (A) [2][5]
FOR 166 SERIES ONLY. NOT FOR 84 & 88 SERIES.

CODE	DESCRIPTION
1	.125/3.17 (FOR .062/1.57 P.C.BOARDS)
2	.170/4.32 (FOR .093/2.36 & .125/3.17 P.C.BOARDS)

SPECIFICATIONS

MATERIALS

- [6] ① Insulator — Thermoplastic Polyester, glass reinforced Rated UL 94V-0. Color: .085/2.16 X .151/3.83 grid, White .085/2.16 X .169/4.29 grid, White .085/2.16 X .160/4.06 grid, Black
- ② Standard Contacts — Copper Alloy 725 Plating: Consult Sales Department for Options.
- ③ Dust Cover/Insertion Cap [9] — Thermoplastic Polycarbonate Rated UL 94V-0. Color: Blue (Plug) Red (Receptacle) Not Available For 166 Series & 8412**V3Δ Connectors [8] If Need Consult Sales Department, Cover To Be Used For One Connector Insertion Only.
- ④ Insert & Stand Off — Brass Qty. 2

PERFORMANCE CHARACTERISTICS

Insulation resistance — 5,000 megohms minimum
Dielectric withstanding voltage (at sea level) — 1000 VAC RMS
Current rating — 1 amp @ 70°C
3 amp @ 20°C
Operating temperature range — -55°C to +105°C
Daughter Card — .054/1.37 TO .071/1.80

Compliant Contact 88 & 166 SERIES

Max. Insertion Force (per contact) — 40 lbs./178 N
Min. Retention Force (per contact) — 10 lbs./44 N

Compliant Contact 84 SERIES

Max. Insertion Force (per contact) — 20 lbs./89 N
Min. Retention Force (per contact) — 5 lbs./22 N

PER ASME Y14.5M-1994
UNLESS OTHERWISE SPECIFIED:
DIMENSIONS ARE IN INCHES OR INCHES/MM
TOLERANCES:
DECIMALS .XX ± .02/0.51
.XXX ± .005/0.127
ANGLES ± SCALE: 1:1

CUSTOMER DRAWING

DRAWN J.T.G.	DATE 5/3/83	APPROVED J.A.D.	DATE 5/10/83
APPROVED J.A.D.	DATE 5/10/83	APPROVED J.A.D.	DATE 5/10/83



Winchester Electronics Corporation
62 Barnes Industrial Road North
Wallingford, Connecticut 06492

TITLE
C - TEL CONNECTOR
PLUG & RECEPTACLE FOR
84, 88, & 166 SERIES

A	23917	SHT. 1 OF 2	REV. N
---	-------	-------------	-----------

REV	DESCRIPTION	BY DATE	APPD
N	REVISED PER ER8145	CMB 05/20/08	CMB

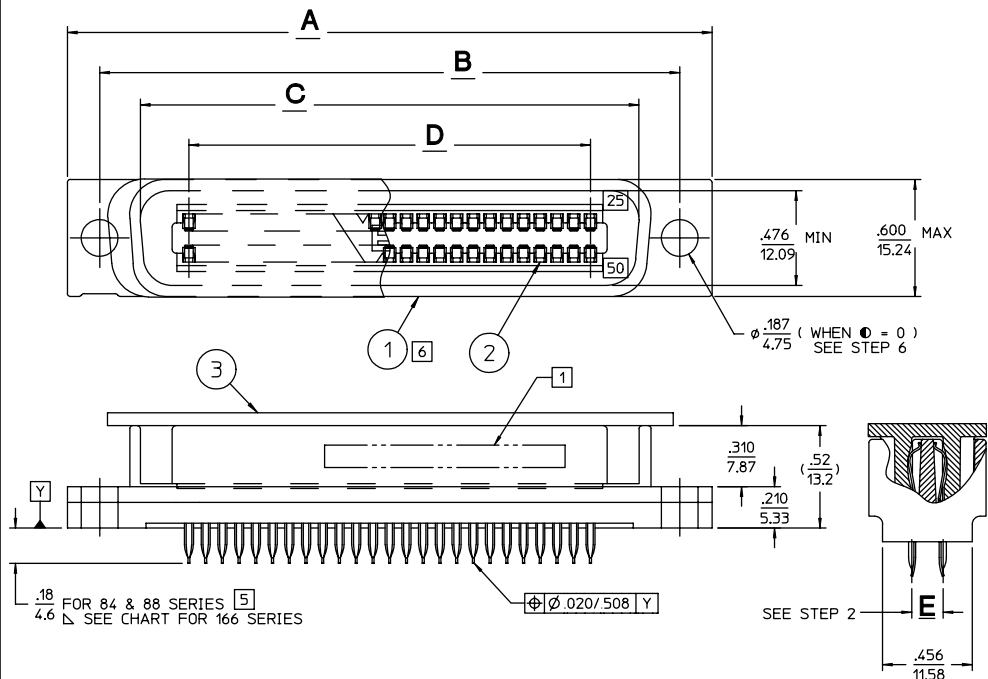

50 POSITION PLUG SHOWN

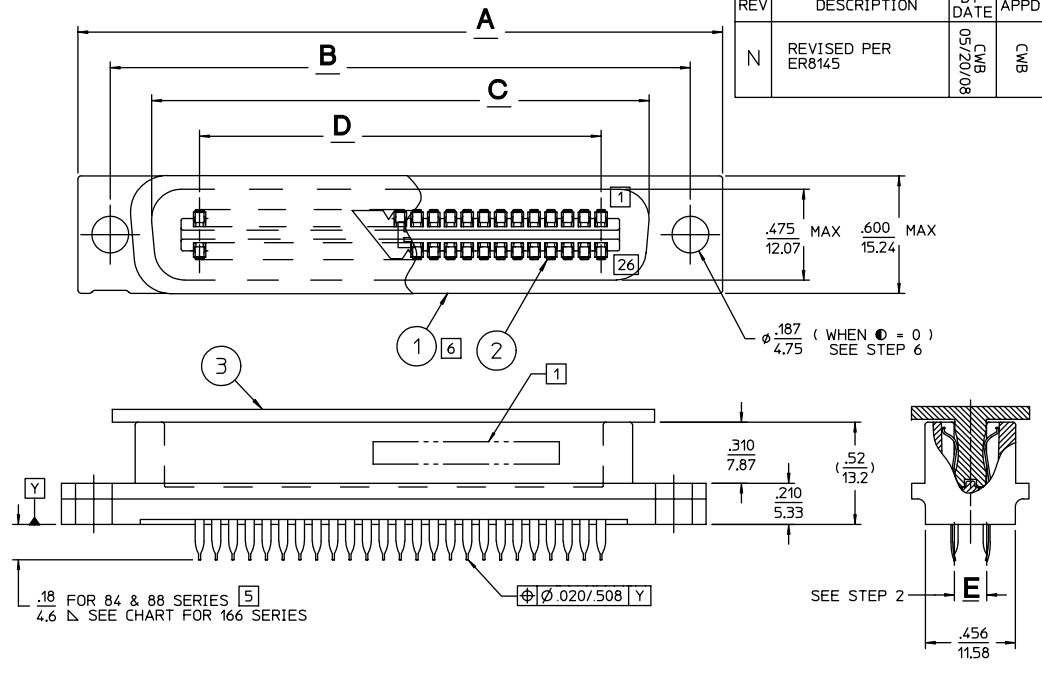

50 POSITION RECEPTACLE SHOWN

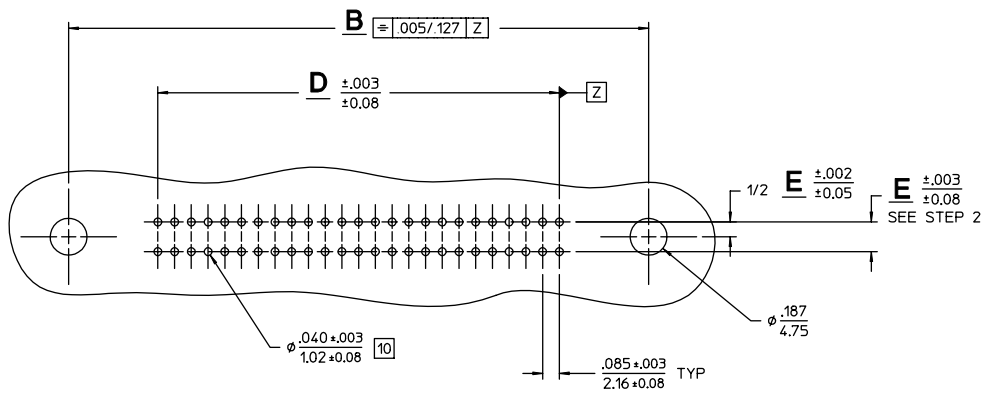

P. C. BOARD HOLE PATTERN

84 & 166 SERIES

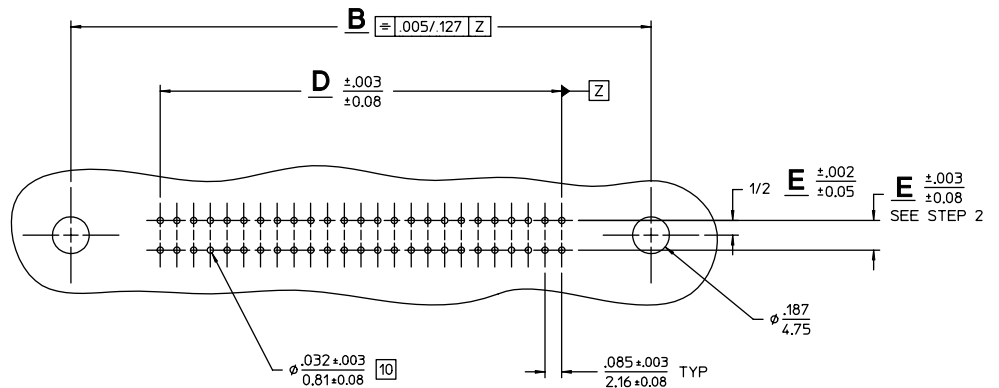

P. C. BOARD HOLE PATTERN

84 SERIES

50	3.275/83.18	2.947/74.85	2.534/64.36	2.527/64.19	2.040/51.82
36	2.680/68.07	2.352/59.74	1.939/49.25	1.932/49.07	1.445/36.70
24	2.170/55.12	1.842/46.79	1.429/36.30	1.422/36.12	.935/23.75
14	1.745/44.32	1.417/35.99	1.004/25.50	.997/25.32	.510/12.95
No. OF CONTACTS	A	B ±.003 ±0.08	C ±.002 ±0.05 PLUG	C ±.002 ±0.05 RECEPT	D ±.003 ±0.08

PER ASME Y14.5M-1994 UNLESS OTHERWISE SPECIFIED: DIMENSIONS ARE IN INCHES OR INCHES/MM			
TOLERANCES: DECIMALS .XX ± .02/0.51 .XXX ± .005/0.127			
ANGLES ±		SCALE: 1:1	
CUSTOMER DRAWING			
DRAWN J.M.G.	DATE 10/10/98	APPROVED L.A.W.	DATE 10/28/98
APPROVED DATE	APPROVED DATE		



Winchester Electronics Corporation
62 Barnes Industrial Road North
Wallingford, Connecticut 06492

TITLE
C - TEL CONNECTOR
PLUG & RECEPTACLE FOR
84, 88, & 166 SERIES

A	23917	SHT.2 OF 2	REV. M
---	-------	------------	-----------