

FEATURES

- Complete Dual 12-Bit DAC
- No External Components
- +5 V Single-Supply Operation $\pm 10\%$
- 4.095 V Full Scale (1 mV/LSB)
- Buffered Voltage Outputs
- Low Power: 5 mW/DAC
- Space Saving 1.5 mm Height SO-14 Package

APPLICATIONS

- Digitally Controlled Calibration
- Servo Controls
- Process Control Equipment
- Computer Peripherals
- Portable Instrumentation
- Cellular Base Stations Voltage Adjustment

FUNCTIONAL BLOCK DIAGRAM

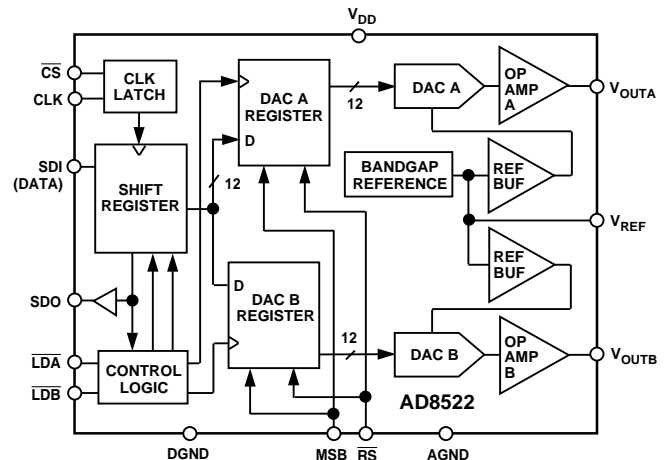

GENERAL DESCRIPTION

The AD8522 is a complete dual 12-bit, single-supply, voltage output DAC in a 14-pin DIP, or SO-14 surface mount package. Fabricated in a CBCMOS process, features include a serial digital interface, onboard reference, and buffered voltage output. Ideal for +5 V-only systems, this monolithic device offers low cost and ease of use, and requires no external components to realize the full performance of the device.

The serial digital interface allows interfacing directly to numerous microcontroller ports, with a simple high speed, three-wire data, clock, and load strobe format. The 16-bit serial word contains the 12-bit data word and DAC select address, which is decoded internally or can be decoded externally using \overline{LDA} , \overline{LDB}

inputs. A serial data output allows the user to easily daisy-chain multiple devices in conjunction with a chip select input. A reset \overline{RS} input sets the outputs to zero scale or midscale, as determined by the input MSB.

The output 4.095 V full scale is laser trimmed to maintain accuracy over the operating temperature range of the device, and gives the user an easy-to-use one-millivolt-per-bit resolution. A 2.5 V reference output is also available externally for other data acquisition circuitry, and for ratiometric applications. The output buffers are capable of driving ± 5 mA.

The AD8522 is available in the 14-pin plastic DIP and low profile 1.5 mm SOIC-14 packages.

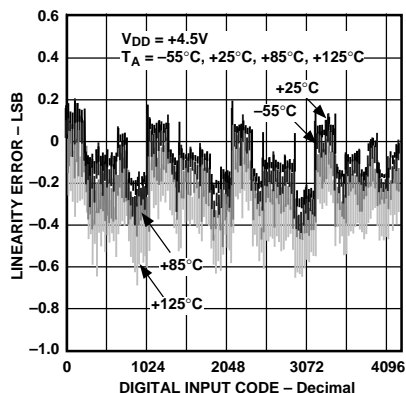
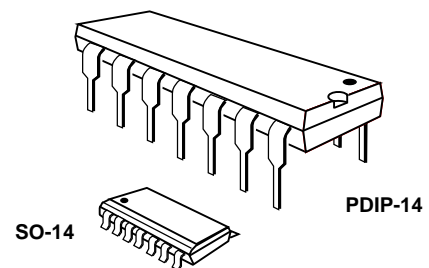

Figure 1. Linearity Error vs. Digital Code & Temperature

REV. A

Information furnished by Analog Devices is believed to be accurate and reliable. However, no responsibility is assumed by Analog Devices for its use, nor for any infringements of patents or other rights of third parties which may result from its use. No license is granted by implication or otherwise under any patent or patent rights of Analog Devices.

PACKAGE TYPES AVAILABLE



AD8522—SPECIFICATIONS

ELECTRICAL CHARACTERISTICS (@ $V_{DD} = +5.0\text{ V} \pm 10\%$, $R_L = \text{No Load}$, $-40^\circ\text{C} \leq T_A \leq +85^\circ\text{C}$, both DACs tested, unless otherwise noted)

Parameter	Symbol	Condition	Min	Typ	Max	Units
STATIC PERFORMANCE						
Resolution ¹	N		12			Bits
Relative Accuracy	INL		-1.5	± 0.5	+1.5	LSB
Differential Nonlinearity	DNL	Monotonic	-1	± 0.5	+1	LSB
Zero-Scale Error	V_{ZSE}	Data = 000 _H		+0.5	+3	mV
Full-Scale Voltage ²	V_{FS}	Data = FFF _H	4.079	4.095	4.111	Volts
Full-Scale Tempco ^{2, 3}	TCV_{FS}			± 15		ppm/°C
MATCHING PERFORMANCE						
Linearity Matching Error	$\Delta V_{FSA/B}$			± 1		LSB
ANALOG OUTPUT						
Output Current	I_{OUT}	Data = 800 _H , $\Delta V_{OUT} \leq 3\text{ LSB}$			± 5	mA
Load Regulation at Half-Scale	LD_{REG}	$R_L = 402\ \Omega$ to ∞ , Data = 800 _H		1	3	LSB
Capacitive Load ³	C_L	No Oscillation		500		pF
REFERENCE OUTPUT						
Output Voltage	V_{REF}		2.484	2.500	2.516	V
Output Source Current ⁴	I_{REF}	$\Delta V_{REF} < 18\text{ mV}$			5	mA
Line Rejection	LN_{REJ}			0.025	0.08	%/V
Load Regulation	LD_{REG}	$I_{REF} = 0$ to 5 mA, Data = 800 _H		0.025	0.1	%/mA
LOGIC INPUTS & OUTPUTS						
Logic Input Low Voltage	V_{IL}				0.8	V
Logic Input High Voltage	V_{IH}		2.4			V
Input Leakage Current	I_{IL}				10	μA
Input Capacitance ³	C_{IL}				10	pF
Logic Output Voltage Low	V_{OL}	$I_{OL} = 1.6\text{ mA}$			0.4	V
Logic Output Voltage High	V_{OH}	$I_{OH} = 400\ \mu\text{A}$	3.5			V
TIMING SPECIFICATIONS^{3, 5}						
Clock Width High	t_{CH}		35			ns
Clock Width Low	t_{CL}		35			ns
Load Pulse Width	t_{LDW}		25			ns
Data Setup	t_{DS}		10			ns
Data Hold	t_{DH}		20			ns
Clear Pulse Width	$t_{CLR\overline{W}}$		20			ns
Load Setup	t_{LD1}		10			ns
Load Hold	t_{LD2}		10			ns
Select	t_{CSS}		30			ns
Deselect	t_{CSH}		30			ns
Clock to SDO Propagation Delay	t_{PD}		20	45	80	ns
AC CHARACTERISTICS^{3, 5}						
Voltage Output Settling Time ⁶	t_S	To ± 1 LSB of Final Value		16		μs
Crosstalk	C_T	Signal Measured at DAC Output, While Changing Opposite $\overline{LDA/B}$		38		dB
DAC Glitch	Q	Half-Scale Transition		13		nV s
Digital Feedthrough	D_{FT}	Signal Measured at DAC Output, While Changing Data Without $\overline{LDA/B}$		2		nV s
SUPPLY CHARACTERISTICS						
Positive Supply Current	I_{DD}	$V_{DD} = 5.5\text{ V}$, $V_{IH} = 2.4\text{ V}$ or $V_{IL} = 0.8\text{ V}$		3	5	mA
		$V_{DD} = 5\text{ V}$, $V_{IL} = 0\text{ V}$		1	2	mA
Power Dissipation ⁷	P_{DISS}	$V_{DD} = 5\text{ V}$, $V_{IH} = 2.4\text{ V}$ or $V_{IL} = 0.8\text{ V}$		15	25	mW
		$V_{DD} = 5\text{ V}$, $V_{IL} = 0\text{ V}$		5	10	mW
Power Supply Sensitivity	PSS	$\Delta V_{DD} = \pm 5\%$		0.002	0.004	%/%

NOTES

¹1 LSB = 1 mV for 0 V to +4.095 V output range.

²Includes internal voltage reference error.

³These parameters are guaranteed by design and not subject to production testing.

⁴Very little sink current is available at the V_{REF} pin. Use external buffer if setting up a virtual ground.

⁵All input control signals are specified with $t_r = t_f = 5\text{ ns}$ (10% to 90% of +5 V) and timed from a voltage level of 1.6 V.

⁶The settling time specification does not apply for negative going transitions within the last 6 LSBs of ground. Some devices exhibit double the typical settling time in this 6 LSB region.

⁷Power Dissipation is calculated $I_{DD} \times 5\text{ V}$.

Specifications subject to change without notice.

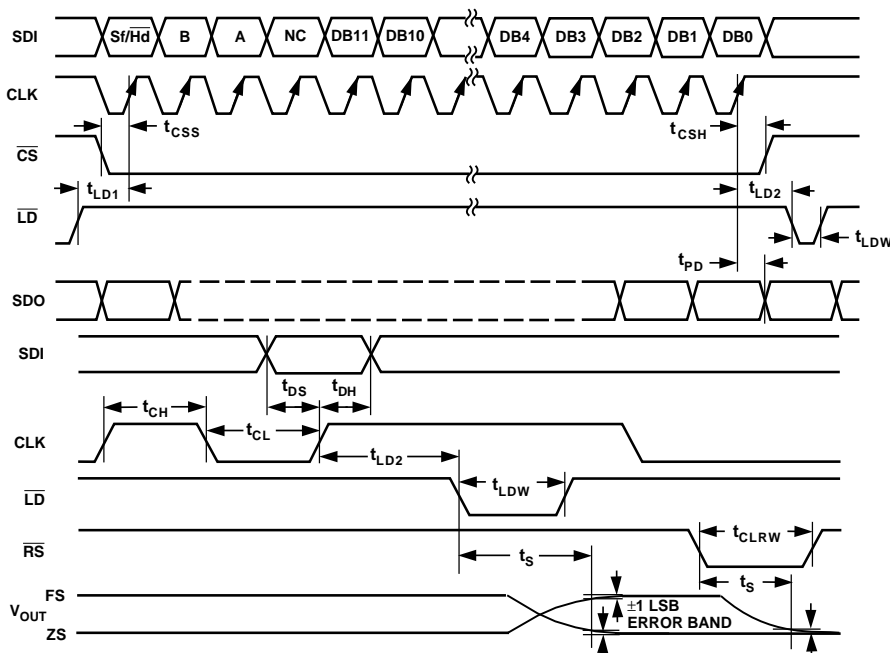

Figure 2. Timing Diagram

SERIAL INPUT REGISTER DATA FORMAT

Last														First	
D0	D1	D2	D3	D4	D5	D6	D7	D8	D9	D10	D11	D12	D13	D14	D15
DB0	DB1	DB2	DB3	DB4	DB5	DB6	DB7	DB8	DB9	DB10	DB11	NC	A	B	Sf/Hd

Table I. Truth Table

Data Word			Ext Pins		DAC Register
Sf/Hd	B	A	LDA	LDB	
Hardware Load:					
L	X	X	↓	↓	Loads DACA + DACB with Data from SR
L	X	X	↓	H	Loads DACA with Data from SR
L	X	X	H	↓	Loads DACB with Data from SR
L	X	X	H	H	No Load
Software Decode Load:					
H	L	L	X	X	No Load
H	H	L	↓	↓	Loads DACB with Data from SR, See Note 1 Below
H	H	L	H	H	No Load
H	L	H	↓	↓	Loads DACA with Data from SR, See Note 1 Below
H	L	H	H	H	No Load
H	H	H	↓	↓	Loads DACA + DACB with Data from SR, See 1 Note Below
H	H	H	H	H	No Load

NOTES

¹In software mode \overline{LDA} and \overline{LDB} perform the same function. They can be tied together or the unused pin should be tied high.

²External Pins \overline{LDA} and \overline{LDB} should always be high when shifting Data into the shift register.

³↓ symbol denotes negative transition.

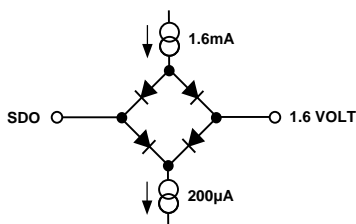

Figure 3. AC Timing SDO Pin Load Circuit

PIN DESCRIPTION

Pin	Function
SDI	Serial Data Input, input data loads directly into the shift register.
CLK	Clock input, positive edge clocks data into shift register.
\overline{CS}	Chip Select, active low input. Prevents shift register loading when high. Does not affect \overline{LDA} and \overline{LDB} operation.
$\overline{LDA/B}$	Load DAC register strobes, active low. Transfers shift register data to DAC register. See truth table for operation. Software decode feature only requires one \overline{LD} strobe. Tie \overline{LDA} and \overline{LDB} together or use one of them with the other pin tied high.
SDO	Serial Data Output. Output of shift register, always active.
\overline{RS}	Resets DAC registers to condition determined by MSB pin. Active low input.
MSB	Digital input: High presets DAC registers to half scale (800_H); Low clears all registers to zero (000_H), when \overline{RS} is strobed to active low.
V_{DD}	Positive +5 V power supply input. Tolerance $\pm 10\%$.
AGND	Analog Ground Input.
DGND	Digital Ground Input.
V_{REF}	Reference Voltage Output, 2.5 V nominal.
$V_{OUT\ A/B}$	DAC A/B voltage outputs, 4.095 V full scale, ± 5 mA output.

PIN CONFIGURATION

14-Pin Plastic DIP

14-Lead SO-14

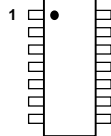
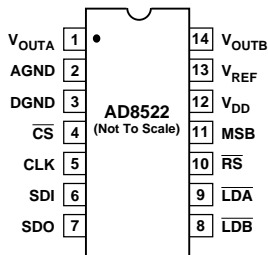

Table II. Truth Tables

\overline{RS}	MSB	DAC Register Preset Register Activity
0	0	Asynchronously Resets DAC Registers to Zero Scale
0	1	Asynchronously Presets DAC Registers to Half Scale (800_H)
1	X	None
\overline{CS}	CLK	Shift Register Shift Register
1	X	No Effect
0	\uparrow	Shifts Register One Bit, SDO Outputs Data from 16 Clocks Earlier

ABSOLUTE MAXIMUM RATINGS*

V_{DD} to DGND & AGND	-0.3 V, +7 V
Logic Inputs and Output to DGND	-0.3 V, $V_{DD} + 0.3$ V
V_{OUT} to AGND	-0.3 V, $V_{DD} + 0.3$ V
V_{REF} to AGND	-0.3 V, $V_{DD} + 0.3$ V
AGND to DGND	-0.3 V, V_{DD}
I_{OUT} Short Circuit to GND or V_{DD}	50 mA
Package Power Dissipation	$(T_J\ max - T_A)/\theta_{JA}$
Thermal Resistance, θ_{JA}	

14-Pin Plastic DIP Package (N-14)	83°C/W
14-Lead SOIC Package (SO-14)	120°C/W
Maximum Junction Temperature ($T_J\ max$)	150°C
Operating Temperature Range	-40°C to +85°C
Storage Temperature Range	-65°C to +150°C
Lead Temperature (Soldering, 10 sec)	+300°C

*Stresses above those listed under "Absolute Maximum Ratings" may cause permanent damage to the device. This is a stress rating only and functional operation of the device at these or any other conditions above those indicated in the operational sections of this specification is not implied. Exposure to absolute maximum rating conditions for extended periods may affect device reliability.

ORDERING GUIDE

Model	Temperature Range	Package Description	Package Option
AD8522AN	-40°C to +85°C	14-Pin P-DIP	N-14
AD8522AR	-40°C to +85°C	14-Lead SOIC	SO-14

The AD8522 contains 1482 transistors.

CAUTION

ESD (electrostatic discharge) sensitive device. Electrostatic charges as high as 4000 V readily accumulate on the human body and test equipment and can discharge without detection. Although the AD8522 features proprietary ESD protection circuitry, permanent damage may occur on devices subjected to high energy electrostatic discharges. Therefore, proper ESD precautions are recommended to avoid performance degradation or loss of functionality.



OPERATION

The AD8522 is a complete ready-to-use dual 12-bit digital-to-analog converter. Only one +5 V power supply is necessary for operation. It contains two voltage-switched, 12-bit, laser-trimmed digital-to-analog converters, a curvature-corrected bandgap reference, rail-to-rail output op amps, input registers, and DAC registers. The serial data interface consists of a serial data input (SDI), clock (CLK), and two load strobe pins ($\overline{\text{LDA}}$, $\overline{\text{LDB}}$) with an active low $\overline{\text{CS}}$ strobe. In addition, an asynchronous $\overline{\text{RS}}$ pin will set all DAC register bits to zero causing the V_{OUT} to become zero volts, or to midscale for trimming applications when the MSB pin is programmed to Logic 1. This function is useful for power on reset or system failure recovery to a known state.

D/A CONVERTER SECTION

The internal DAC is a 12-bit voltage-mode device with an output that swings from AGND potential to the 2.5 V internal bandgap voltage. It uses a laser-trimmed R-2R ladder which is switched by N channel MOSFETs. The output voltage of the DAC has a constant resistance independent of digital input code. The DAC output is internally connected to the rail-to-rail output op amp.

AMPLIFIER SECTION

The internal DAC's output is buffered by a low power consumption precision amplifier. This low power amplifier contains a differential PNP pair input stage that provides low offset voltage and low noise, as well as the ability to amplify the zero-scale DAC output voltages. The rail-to-rail amplifier is configured in a gain of 1.638 ($= 4.095 \text{ V}/2.5 \text{ V}$) in order to set the 4.095 V full-scale output (1 mV/LSB). See Figure 4 for an equivalent circuit schematic of the analog section.

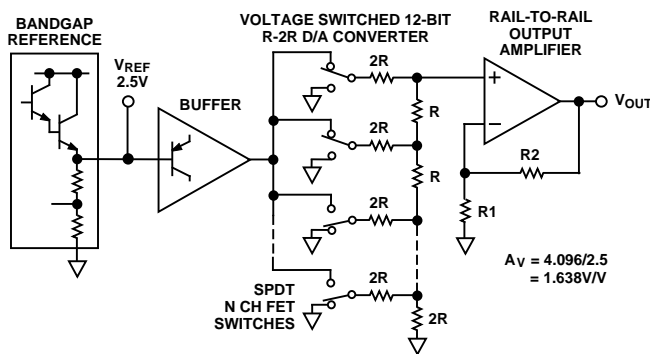

Figure 4. Equivalent AD8522 Schematic of Analog Portion

The op amp has a 16 μs typical settling time to 0.01%. There are slight differences in settling time for negative slewing signals versus positive. See the oscilloscope photos in the "Typical Performance Characteristics" section of this data sheet.

OUTPUT SECTION

The rail-to-rail output stage of this amplifier has been designed to provide precision performance while operating near either power supply. Figure 5 shows an equivalent output schematic of the rail-to-rail amplifier with its N channel pull-down FETs that will pull an output load directly to GND. The output sourcing current is provided by a P channel pull-up device that can supply GND terminated loads, especially important at the -10% supply tolerance value of 4.5 V.

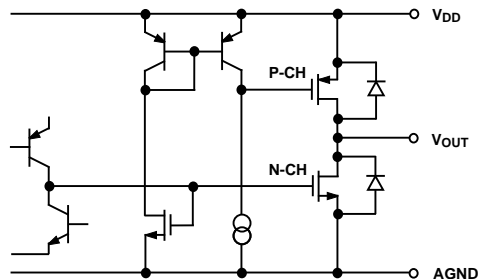

Figure 5. Equivalent Analog Output Circuit

Figures 6 and 7 in the typical performance characteristics section provide information on output swing performance near ground and full scale as a function of load. In addition to resistive load driving capability the amplifier has also been carefully designed and characterized for up to 500 pF capacitive load driving capability.

REFERENCE SECTION

The internal 2.5 V curvature-corrected bandgap voltage reference is laser trimmed for both initial accuracy and low temperature coefficient. The voltage generated by the reference is available at the V_{REF} pin. Since V_{REF} is *not* intended to drive heavy external loads, it must be buffered. The equivalent emitter follower output circuit of the V_{REF} pin is shown in Figure 4.

Bypassing the V_{REF} pin will improve noise performance; however, bypassing is not required for proper operation. Figure 10 shows broad band noise performance.

POWER SUPPLY

The very low power consumption of the AD8522 is a direct result of a circuit design optimizing use of a CBCMOS process. By using the low power characteristics of the CMOS for the logic, and the low noise, tight matching of the complementary bipolar transistors good analog accuracy is achieved.

For power consumption sensitive applications it is important to note that the internal power consumption of the AD8522 is strongly dependent on the actual input voltage levels present on the SDI, CLK, $\overline{\text{CS}}$, MSB, $\overline{\text{LDA}}$, $\overline{\text{LDB}}$ and $\overline{\text{RS}}$ pins. Since these inputs are standard CMOS logic structures, they contribute static power dissipation dependent on the actual driving logic V_{OH} and V_{OL} voltage levels. Consequently for optimum dissipation use of CMOS logic versus TTL provides minimal dissipation in the static state. A $V_{\text{INL}} = 0 \text{ V}$ on the logic input pins provides the lowest standby dissipation of 1 mA with a +5 V power supply.

As with any analog system, it is recommended that the AD8522 power supply be bypassed on the same PC card that contains the chip. Figure 12 shows the power supply rejection versus frequency performance. This should be taken into account when using higher frequency switched-mode power supplies with ripple frequencies of 100 kHz and higher.

One advantage of the rail-to-rail output amplifiers used in the AD8522 is the wide range of usable supply voltage. The part is fully specified and tested over temperature for operation from +4.5 V to +5.5 V. If reduced linearity and source current capability near full scale can be tolerated, operation of the AD8522

AD8522

is possible down to +4.3 V. The minimum operating supply voltage versus load current plot, in Figure 7, provides information for operation below $V_{DD} = +4.5$ V.

TIMING AND CONTROL

The AD8522 has a 16-bit serial input register that accepts clocked in data when the CS pin is active low. The DAC registers are updated by the Load Enable (\overline{LDA} and \overline{LDB}) pins.

The AD8522 offers two modes of data loading. The first mode, hardware-load, directs the data currently clocked into the serial shift register into either the DAC A or the DAC B register or both depending on the external active low strobing of the \overline{LDA} or \overline{LDB} pin. Serial data register bit Sf/\overline{HD} must be low for this mode to be in effect.

The second mode of operation is software-load which is designed to minimize the number of control lines connected to the AD8522. In this mode of operation the \overline{LDA} and \overline{LDB} pins act as one control input taking the present contents of the serial

input register and transferring the 12 bits of data into the decoded address determined by the address bits A and B in the serial input register.

Unipolar Output Operation

This is the basic mode of operation for the AD8522. The AD8522 has been designed to drive loads as low as 820 Ω in parallel with 500 pF. The code table for this operation is shown in Table III.

Table III. Unipolar Code Table

Hexadecimal Number in DAC Register	Decimal Number in DAC Register	Analog Output Voltage (V)
FFF	4095	+4.095
801	2049	+2.049
800	2048	+2.048
7FF	2047	+2.047
000	0	0

Typical Performance Characteristics

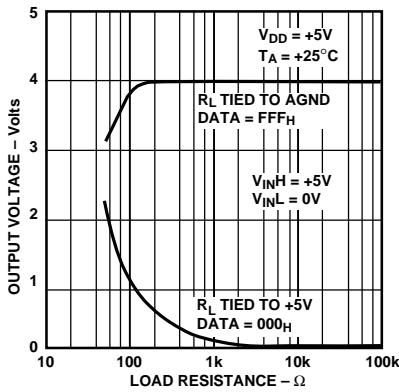

Figure 6. Output Swing vs. Load

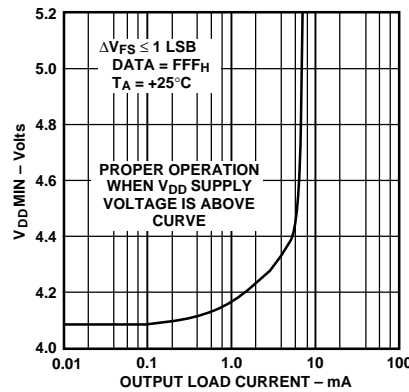

Figure 7. Minimum Supply Voltage vs. Load Current

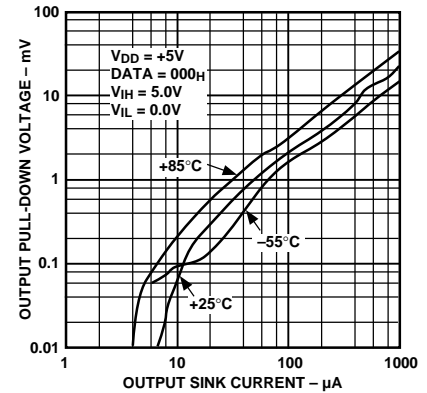

Figure 8. Pull-Down Voltage vs. Output Sink Current Capability

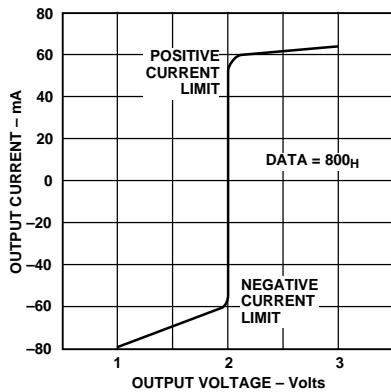

Figure 9. I_{OUT} vs. V_{OUT}

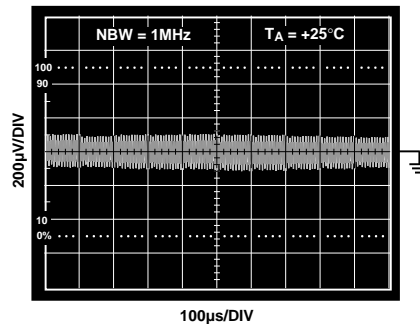

Figure 10. Broadband Noise

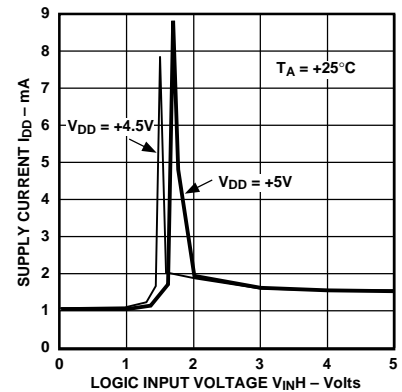

Figure 11. Supply Current vs. Logic Input Voltage

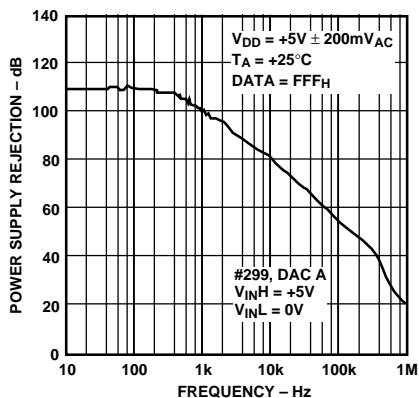

Figure 12. Power Supply Rejection vs. Frequency

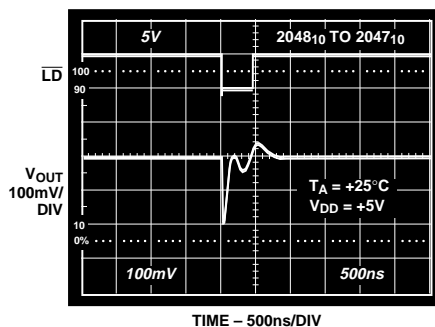

Figure 13. Midscale Transition Performance

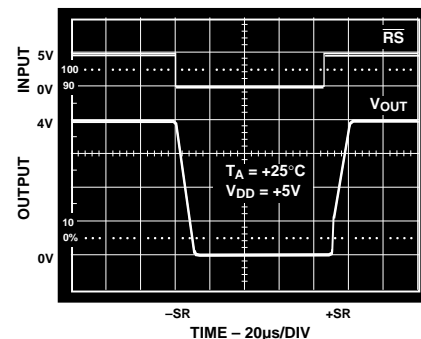

Figure 14. Large Signal Settling Time

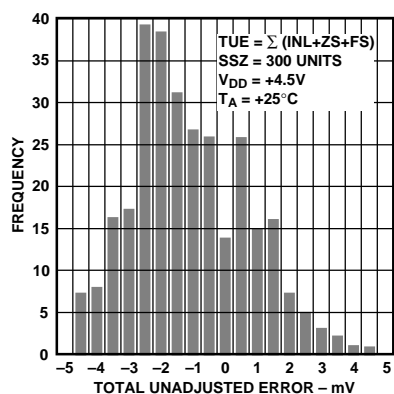

Figure 15. Total Unadjusted Error Histogram

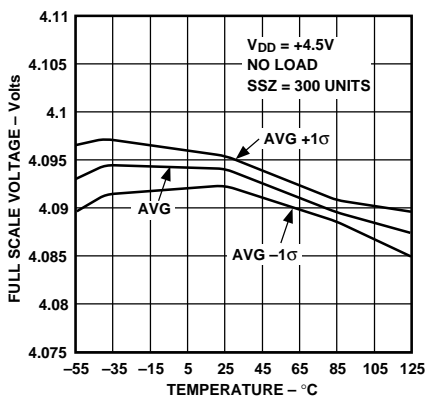

Figure 16. Full-Scale Voltage vs. Temperature

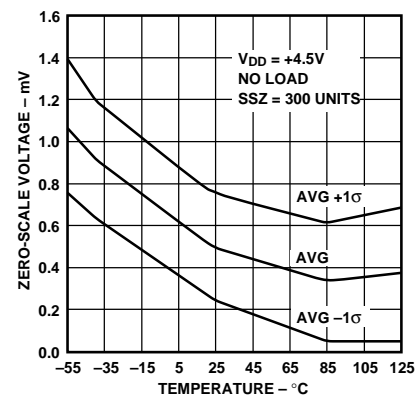

Figure 17. Zero-Scale Voltage vs. Temperature

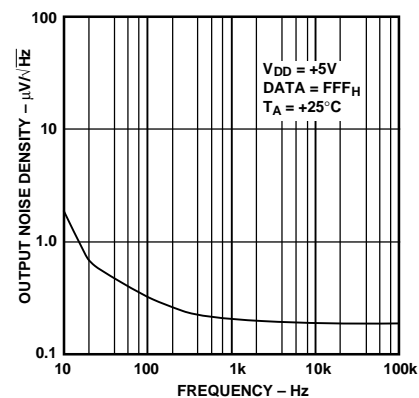

Figure 18. Output Voltage Noise Density vs. Frequency

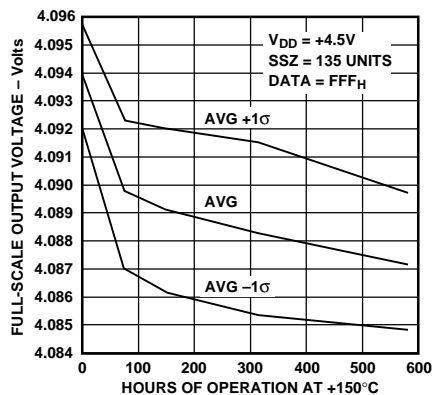

Figure 19. Long Term Drift Accelerated by Burn-In

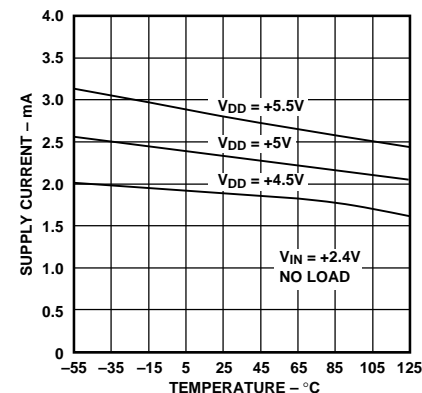

Figure 20. Supply Current vs. Temperature

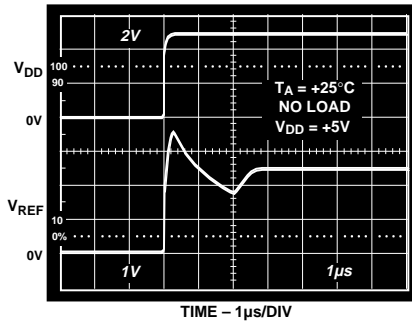

Figure 21. Reference Startup vs. Time

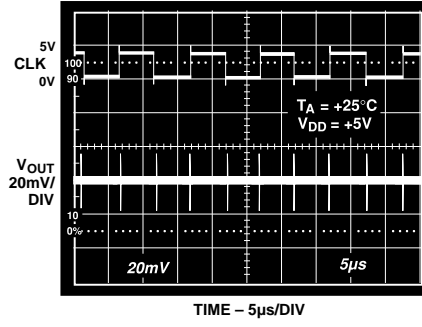

Figure 22. Digital Feedthrough vs. Time

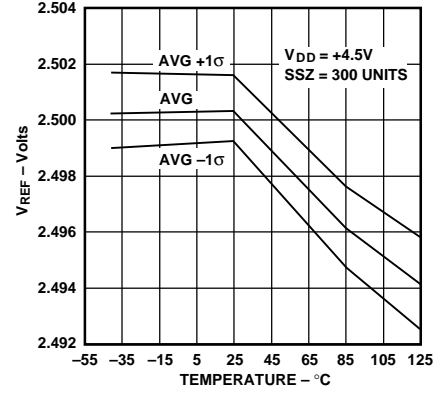

Figure 23. Reference Voltage vs. Temperature

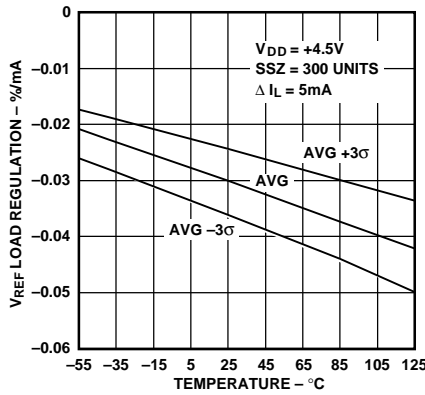

Figure 24. Reference Load Regulation vs. Temperature

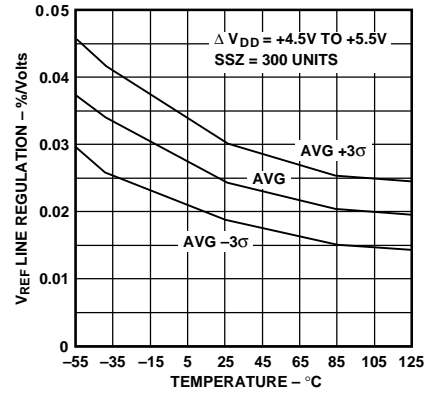
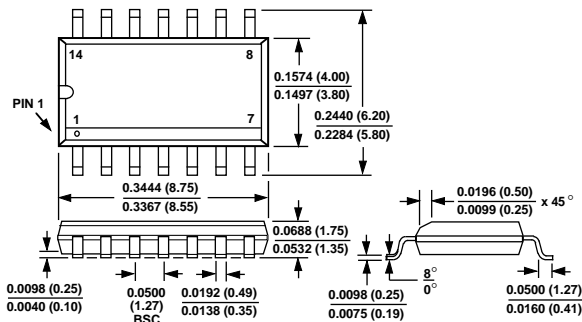

Figure 25. Reference Line Regulation vs. Temperature

OUTLINE DIMENSIONS

Dimensions shown in inches and (mm).

14-Lead Narrow Body SOIC (SO-14)



14-Lead Epoxy DIP (N-14)

